

EAGLE40-07 HiSecOS Rel. 05101

Reference Manual
Graphical User Interface

User Manual
Configuration





HIRSCHMANN

[Empty grid lines for data entry]



















+

-

















✓











+





≡

≡

≡

≡

























+

x





\mathbb{B}^+

\mathbb{B}^{\times}

\mathbb{B}^+





田+







+

x



























+

x











□

+

-



+

x











B+

B+



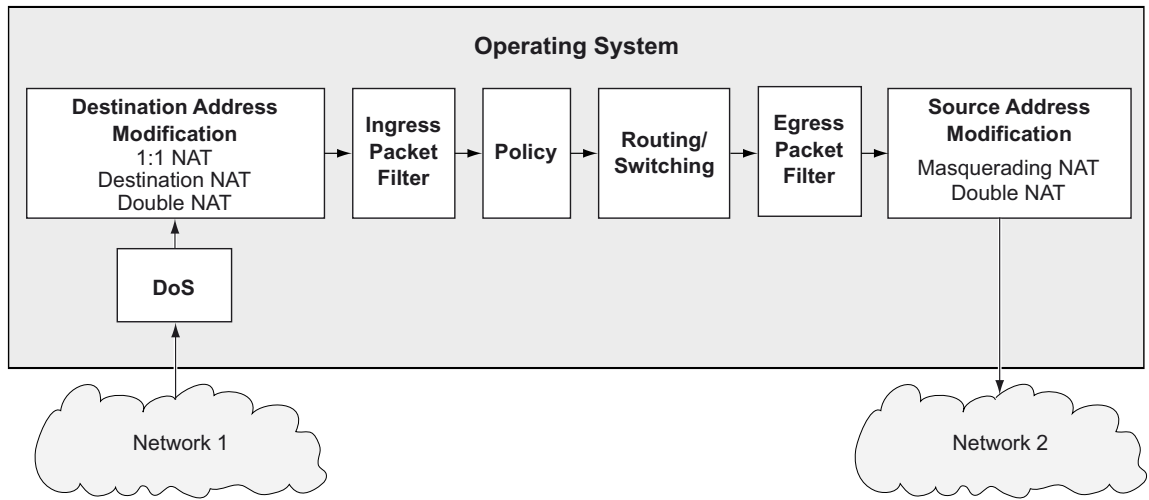







甲+





+

x















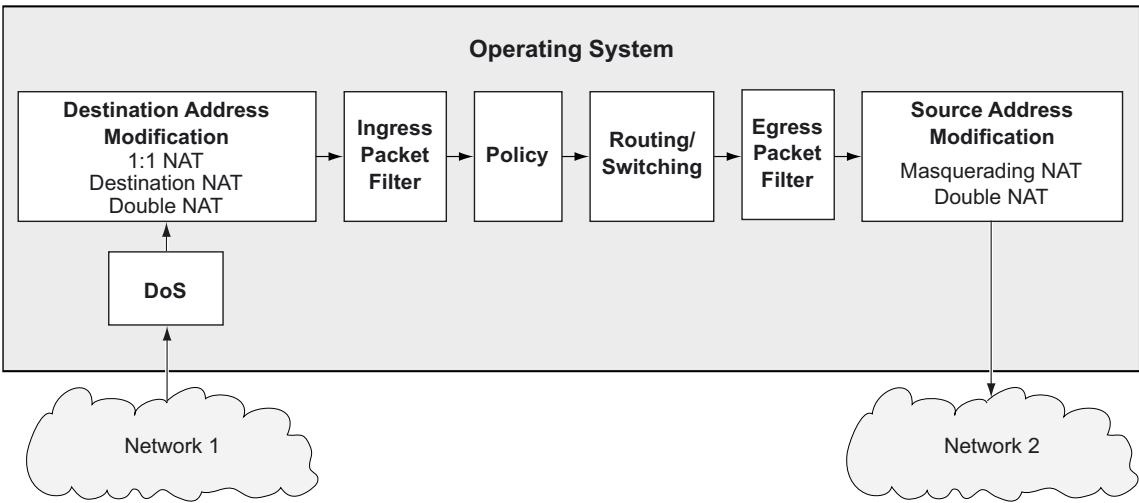





B+

B×



























[Redacted header area]

[Lined writing area]













⌘ +

✕







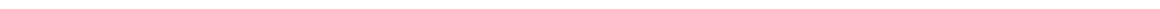
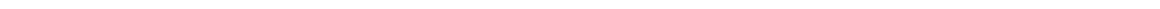
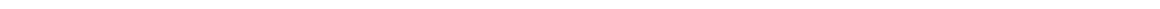









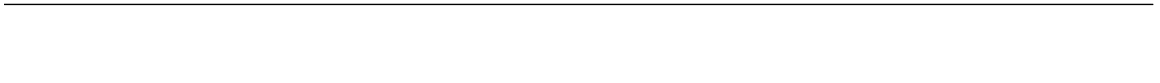
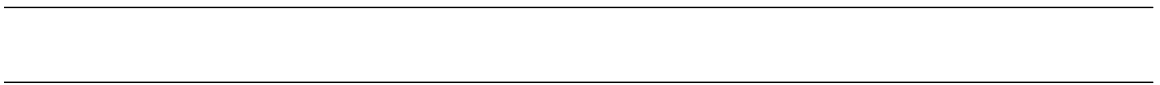
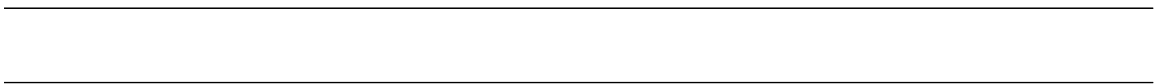
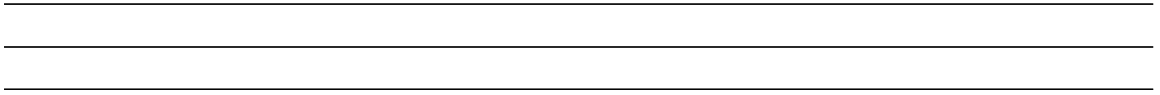

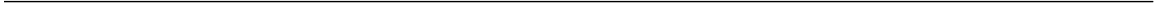
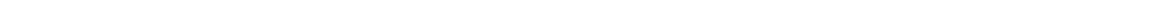
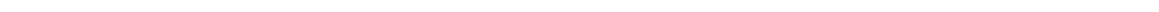
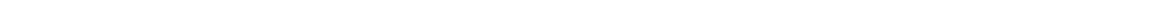
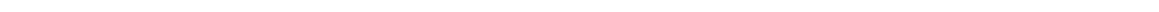
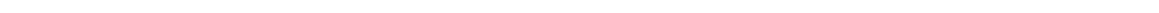
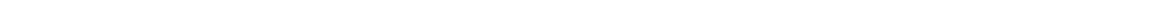
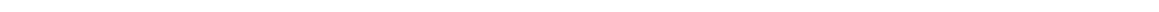
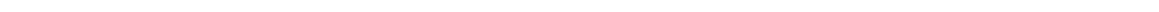
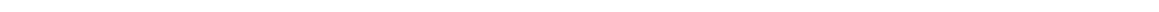
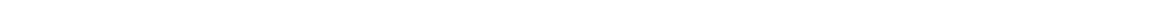
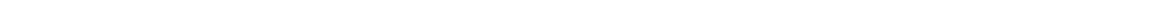
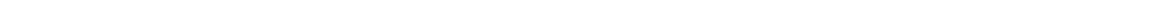

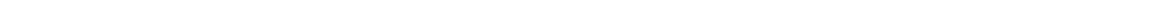
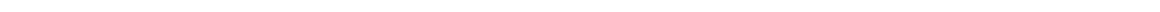
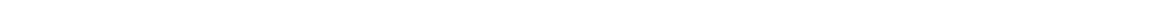
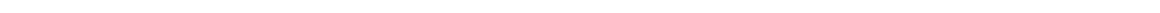
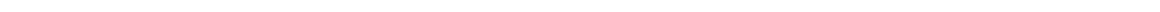

A series of horizontal black lines spaced evenly down the page, providing a template for writing.

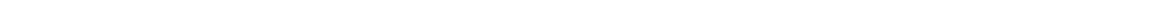
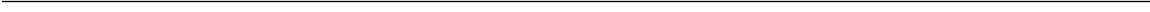
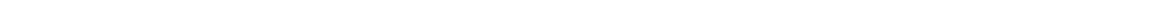
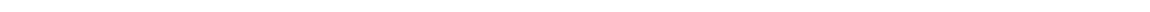













A series of horizontal lines for writing, consisting of 28 evenly spaced lines.











-XXXXXXXXXX

-XXXXXXXXXX

-XXXXXXXXXX

-XXXXXXXXXX

-XXXXXXXXXX

- [REDACTED]

- [REDACTED]

- [REDACTED]

- [REDACTED]

- [REDACTED]

- [REDACTED]









Ⓚ+

Ⓚ×



_____	_____
_____	_____
_____	_____
_____	_____
_____	_____

_____	_____
_____	_____

_____	_____
_____	_____
_____	_____
_____	_____
_____	_____
_____	_____
_____	_____
_____	_____

[Blue shaded header bar]

[Lined writing area 1]

[Lined writing area 2]

[Lined writing area 3]

[Lined writing area 4]

[Lined writing area 5]

[Lined writing area 6]

[Lined writing area 7]

_____	_____
_____	_____
_____	_____
_____	_____
_____	_____
_____	_____
_____	_____
_____	_____
_____	_____
_____	_____
_____	_____
_____	_____

_____	_____
_____	_____
_____	_____
_____	_____
_____	_____
_____	_____
_____	_____
_____	_____
_____	_____
_____	_____
_____	_____

_____	_____
_____	_____
_____	_____
_____	_____

_____	_____
-------	-------

_____	_____
-------	-------

_____	_____
-------	-------

_____	_____
-------	-------

_____	_____
-------	-------





[Redacted header section]

[Redacted]	[Redacted]
[Redacted]	[Redacted]
[Redacted]	[Redacted]
[Redacted]	[Redacted]
[Redacted]	[Redacted]
[Redacted]	[Redacted]
[Redacted]	[Redacted]
[Redacted]	[Redacted]
[Redacted]	[Redacted]
[Redacted]	[Redacted]
[Redacted]	[Redacted]
[Redacted]	[Redacted]
[Redacted]	[Redacted]
[Redacted]	[Redacted]
[Redacted]	[Redacted]
[Redacted]	[Redacted]
[Redacted]	[Redacted]
[Redacted]	[Redacted]
[Redacted]	[Redacted]
[Redacted]	[Redacted]
[Redacted]	[Redacted]
[Redacted]	[Redacted]
[Redacted]	[Redacted]

[Redacted header section]

[Redacted]

[Redacted]

[Redacted]

[Redacted]



Handwriting practice lines consisting of a series of horizontal lines. The lines are organized into groups, with some groups having a top line that is slightly indented from the left margin. There are 15 such groups of lines.



[Redacted header bar]

[Redacted content area]



Handwritten text in a cursive script, consisting of approximately 10 lines of text.



Handwritten text in a cursive script, consisting of approximately 10 lines of text.

##

Blank header box

[Blue shaded header bar]

[Blank lined area]

[Blank lined area]

[Blank lined area]

[Blank lined area]

[Blank lined area]

[Blank lined area]

[Blank lined area]

[Blank lined area]

[Blank lined area]

[Blank lined area]

[Blank lined area]

[Blank lined area]

[Blank lined area]

[Blank lined area]

[Blank lined area]

[Blank lined area]

[Blank lined area]

[Blank lined area]

[Blank lined area]

[Blue shaded header bar]

[Lined writing area 1]

[Lined writing area 2]

[Lined writing area 3]

[Lined writing area 4]

[Lined writing area 5]

[Lined writing area 6]

[Lined writing area 7]

[Lined writing area 8]

[Blue shaded header bar]

[Lined writing area 1]

[Lined writing area 2]

[Lined writing area 3]

[Lined writing area 4]

[Lined writing area 5]

[Blue shaded header bar]

[Lined writing area 1]

[Lined writing area 2]

[Lined writing area 3]

[Lined writing area 4]

[Lined writing area 5]

[Lined writing area 6]

[Blue shaded header bar]

[Blank lined section 1]

[Blank lined section 2]

[Blank lined section 3]

[Blank lined section 4]

[Blank lined section 5]

[Blank lined section 6]

[Blank lined section 7]

[Blank lined section 8]

[Blank lined section 9]

[Blue header bar]

[Lined writing area]

[Lined writing area]

[Lined writing area]

[Lined writing area]

[Lined writing area]

[Lined writing area]

[Lined writing area]

[Lined writing area]

[Lined writing area]

[Lined writing area]

[Lined writing area]

[Lined writing area]

[Blue bar]

[Line 1] [Line 2] [Line 3]

[Line 4] [Line 5] [Line 6] [Line 7]

[Line 8] [Line 9] [Line 10] [Line 11]

[Line 12] [Line 13]

[Line 14] [Line 15]

[Line 16] [Line 17]

[Line 18] [Line 19]

[Line 20] [Line 21]

[Line 22] [Line 23]

[Line 24] [Line 25]

[Line 26] [Line 27]

[Line 28] [Line 29]

[Line 30] [Line 31]

[Line 32] [Line 33]

[Line 34] [Line 35]

- _____
- _____
- _____
- _____
- _____
- _____
- _____

- _____
- _____
- _____
- _____
- _____
- _____

[Redacted]

[Redacted]

[Redacted]

[Redacted]

[Redacted]

[Blue shaded header bar]

[Lined writing area]

[Lined writing area]



⌘+

⌘x























































B+

Bx















⌘ +

⌘ x

















\mathbb{B}^+

\mathbb{B}^{\times}











×











⊕

⊗













+

x



B+

Bx













⌘ +









⌘ +



\mathbb{R}^+

\mathbb{R}^{\times}

















×

×



+

x









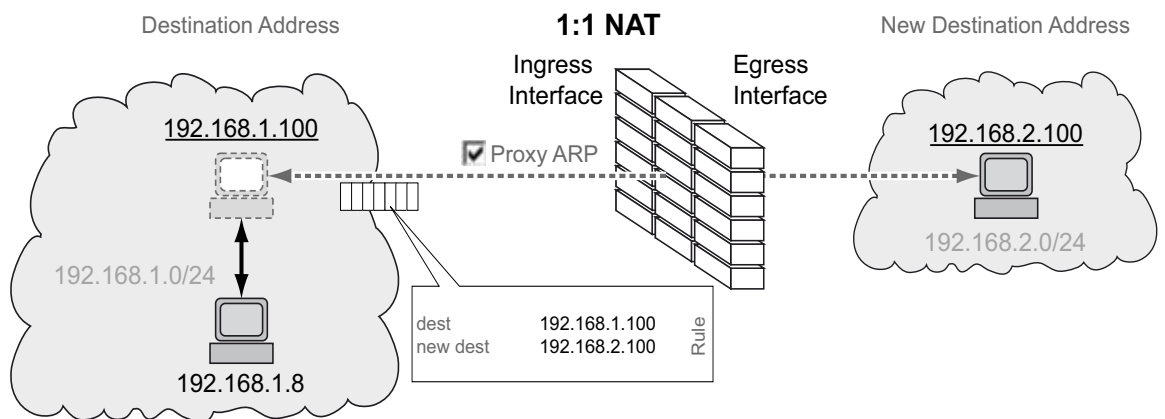

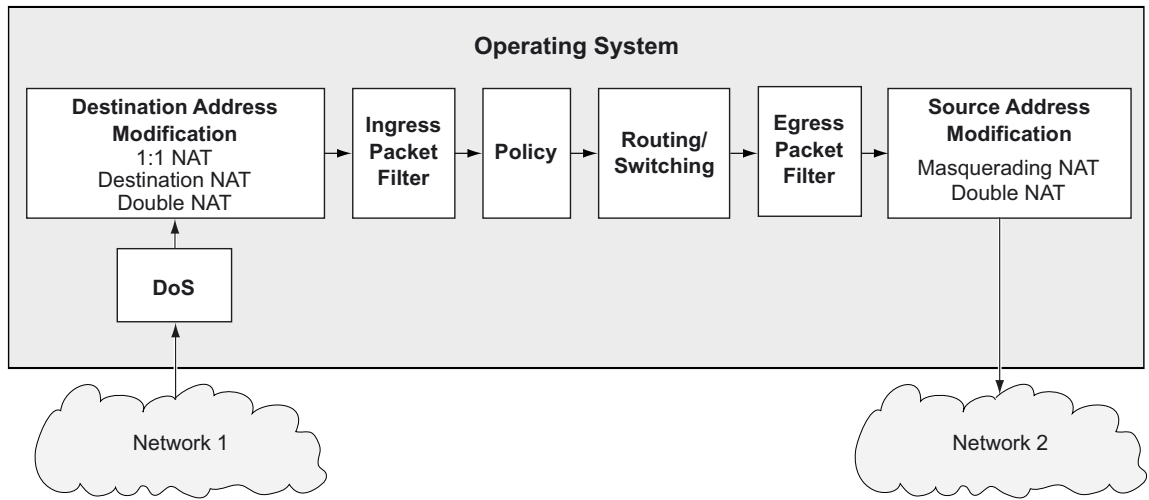

Ⓜ
+

Ⓜ
x



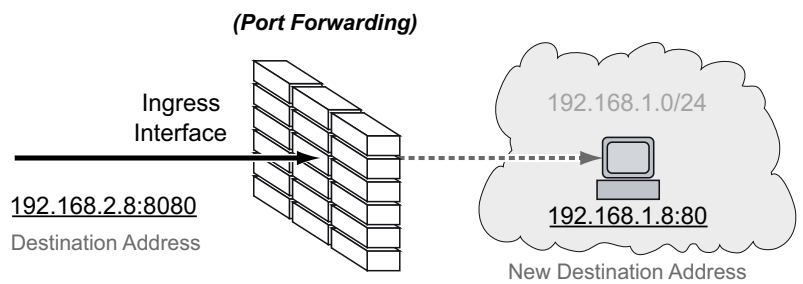
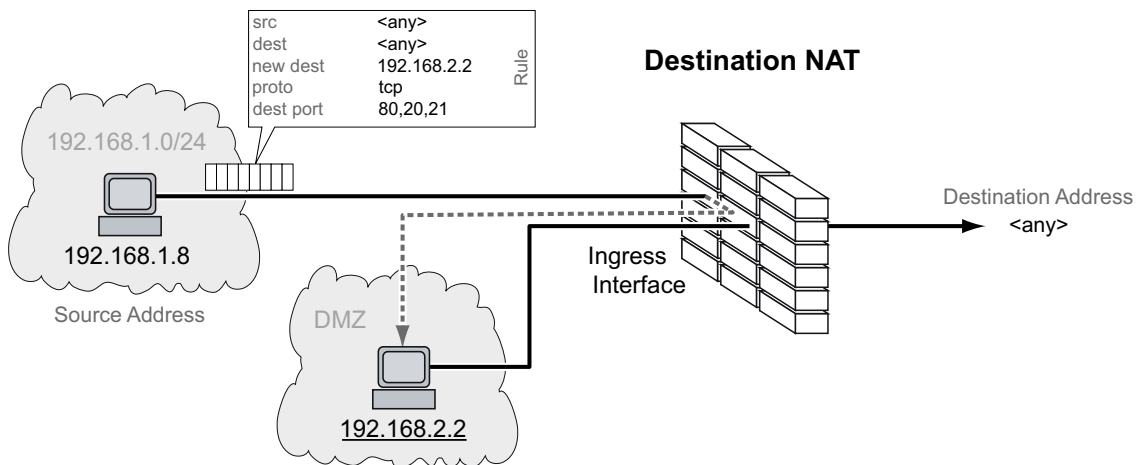

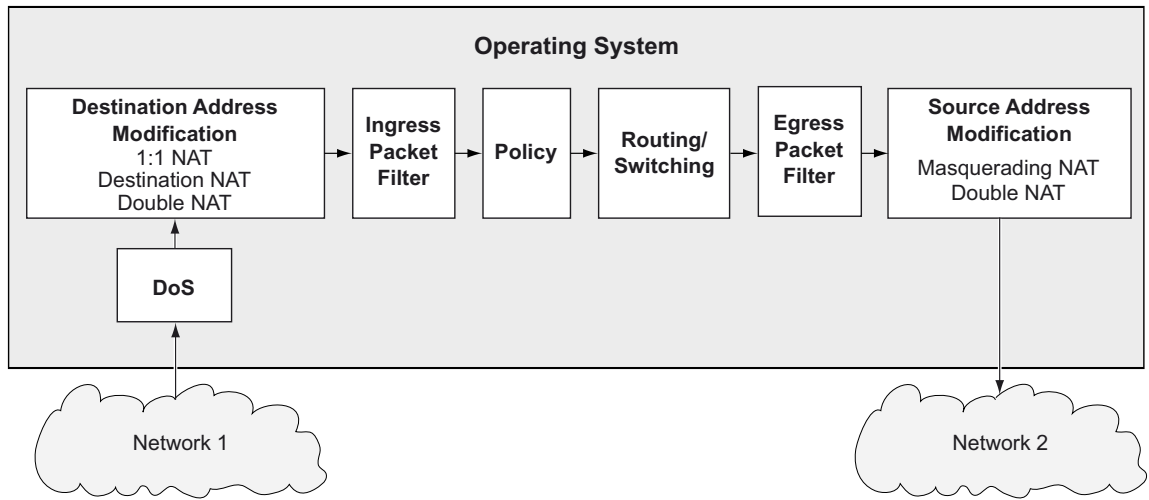

⊕

⊗









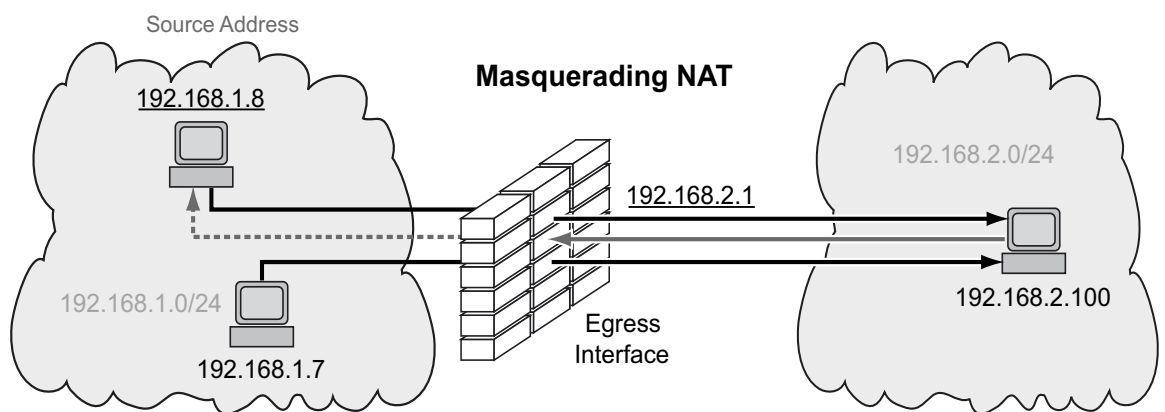

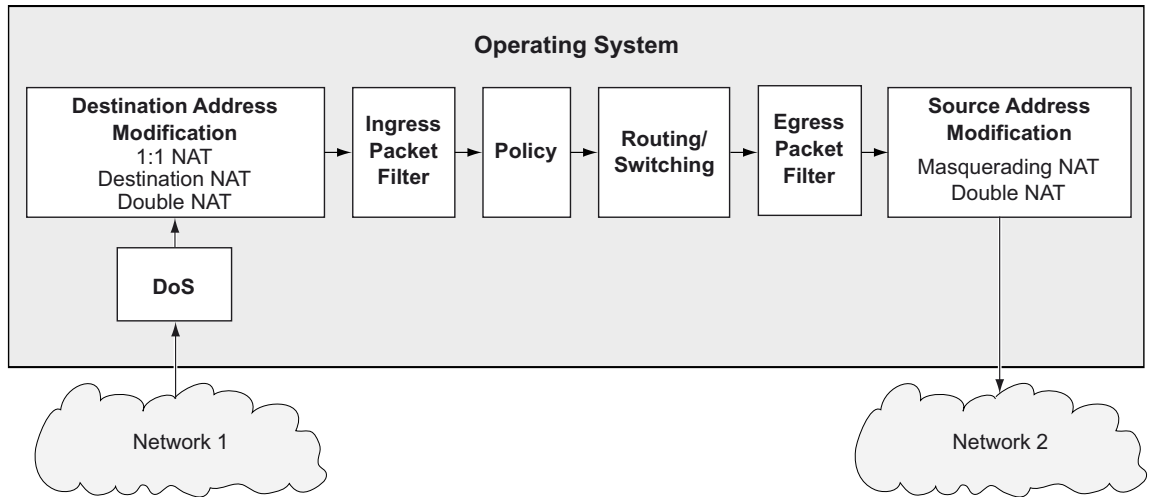

⊕

⊗







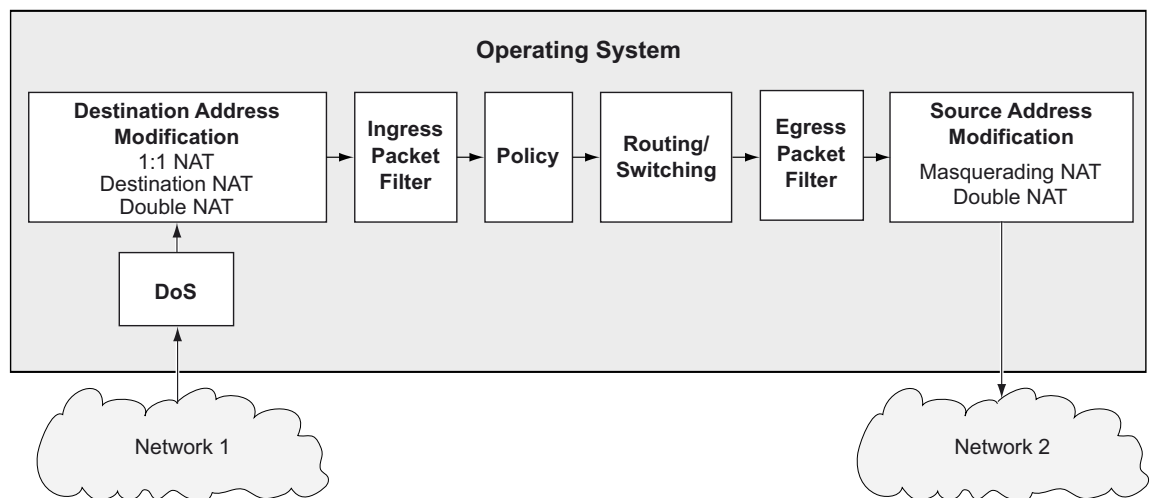
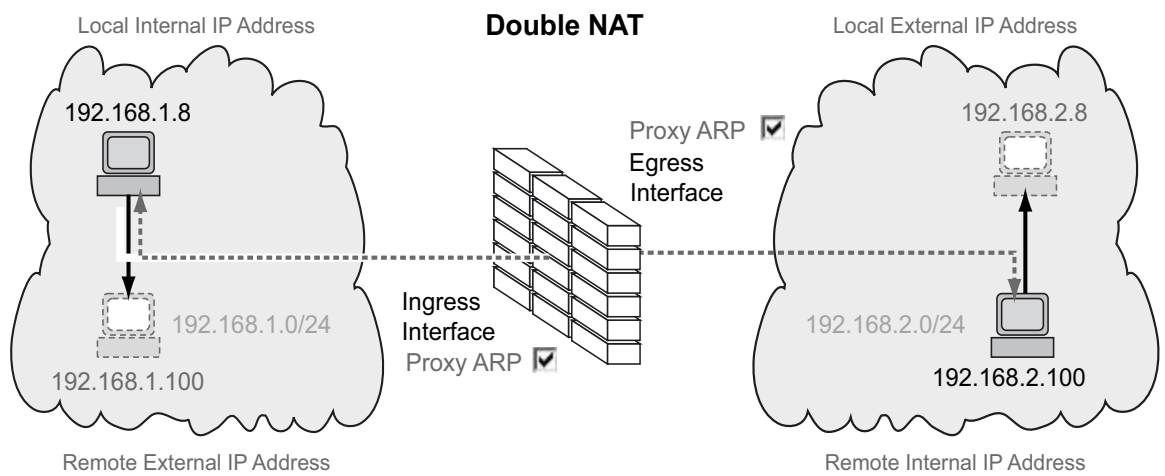

Ⓜ
+

✕





















+

x





□

+



+

x

















[Redacted]

- [Redacted]

[Redacted]

[Redacted]

[Redacted]

[Redacted]

[Redacted]









B+

B×







β_+

β_x





⌘ +

+

x







+









HIRSCHMANN

















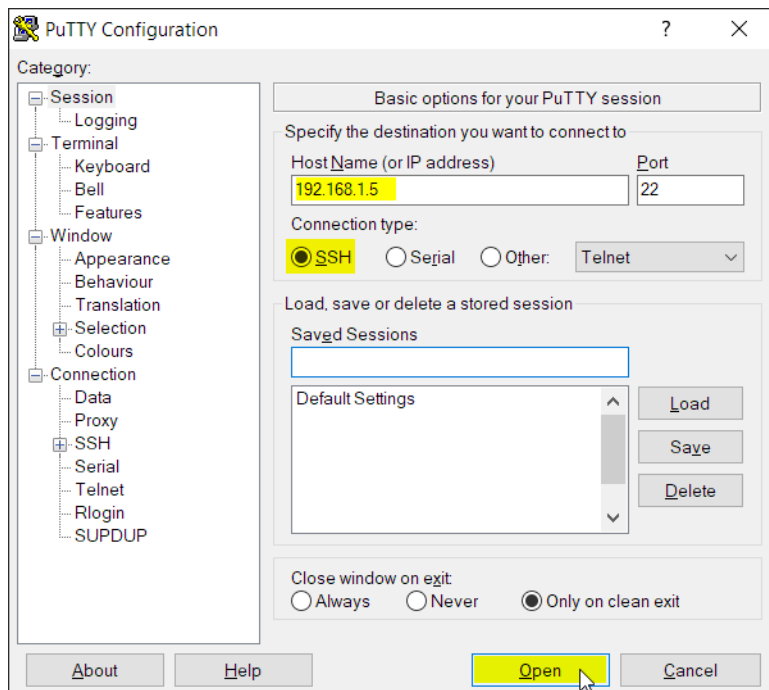

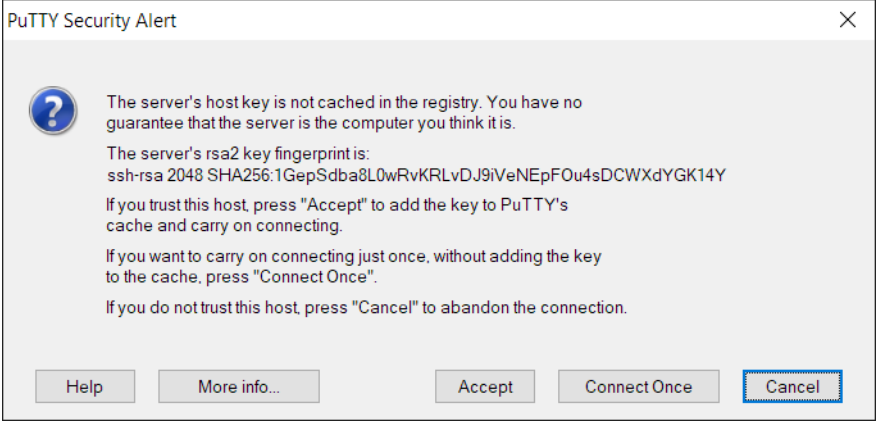

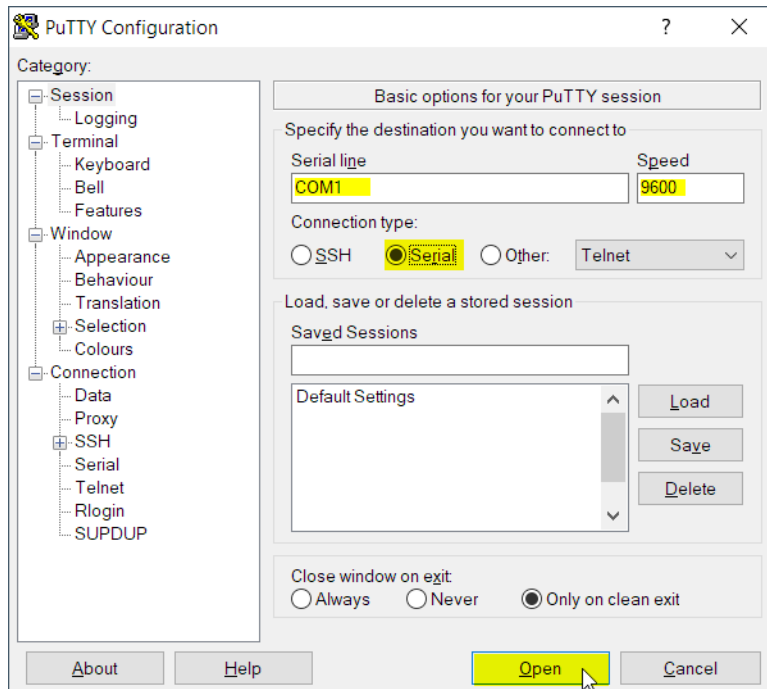

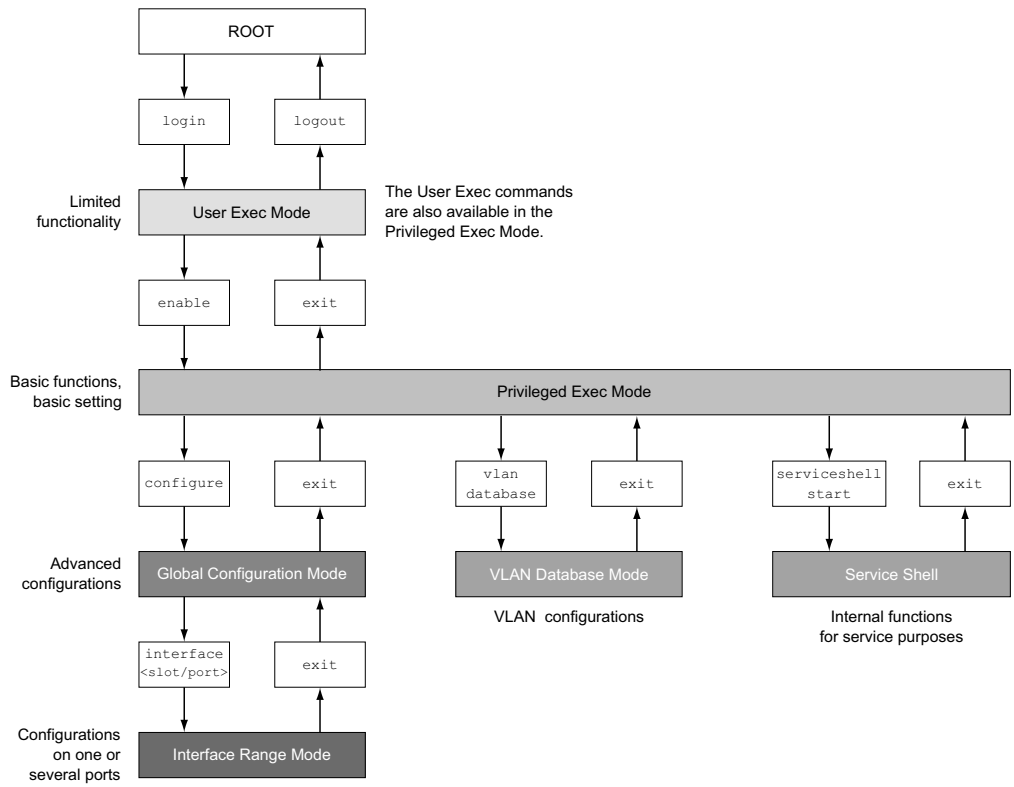





[Blue shaded bar]





0	Net ID - 7 bits	Host ID - 24 bits	Class A
1 0	Net ID - 14 bits	Host ID - 16 bits	Class B
1 1 0	Net ID - 21 bits	Host ID - 8 bits	Class C
1 1 1 0	Multicast Group ID - 28 bits		Class D
1 1 1 1	reserved for future use - 28 bits		Class E

Decimal notation
255.255.192.0

Binary notation
11111111.11111111.11000000.00000000

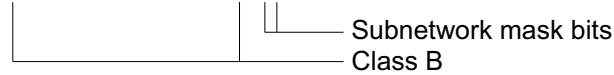

Decimal notation

129.218.65.17

└─── 128 < 129 191 > Class B

Binary notation

10000001.11011010.01000001.00010001

└─── Subnetwork 1
└─── Network address

Decimal notation

129.218.129.17

└─── 128 < 129 191 > Class B

Binary notation

10000001.11011010.10000001.00010001

└─── Subnetwork 2
└─── Network address

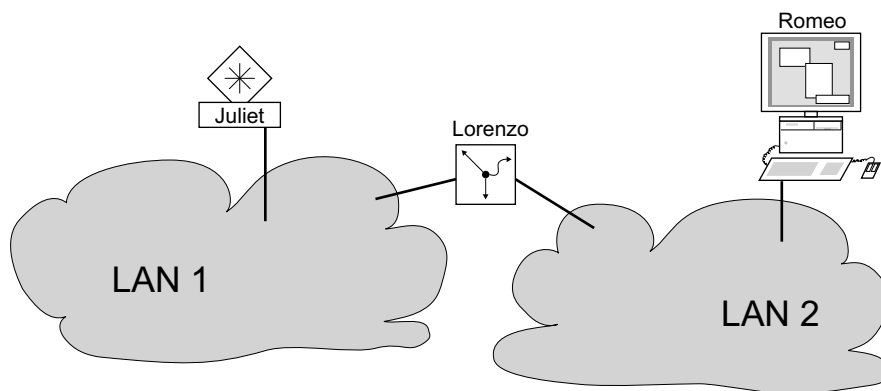

IP address, decimal	Network mask, decimal	IP address, binary
192.168.112.1	255.255.255.128	11000000 10101000 01110000 00000001
192.168.112.127		11000000 10101000 01110000 01111111
		└────────── 25 mask bits ─────────┘

CIDR notation: 192.168.112.0/25

└────────── Mask bits ─────────┘

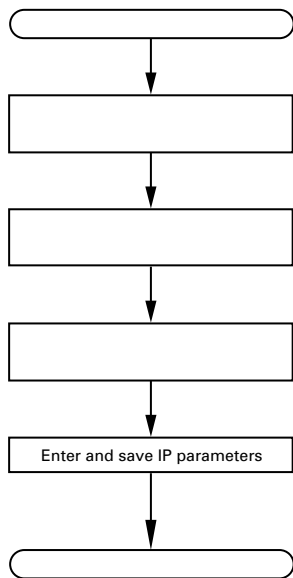

```
NOTE: Enter '?' for Command Help. Command help displays all opt
that are valid for the particular mode.
For the syntax of a particular command form, please
consult the documentation.

! ( )>
```



Id	MAC Address	Writable	IP Address	Net Mask	Default Gateway	Product	Name
1	00:80:63:A4:CC:00	<input checked="" type="checkbox"/>	10.115.0.76	255.255.224.0	10.115.0.3		
2	00:80:63:C0:50:00	<input type="checkbox"/>	10.115.0.33	255.255.224.0	10.115.0.3		
3	00:80:63:A3:40:00	<input type="checkbox"/>	10.115.0.70	255.255.224.0	10.115.0.3		
4	00:80:63:98:14:00	<input type="checkbox"/>	10.115.0.17	255.255.224.0	10.115.0.3		
5	00:80:63:9E:E4:00	<input type="checkbox"/>	0.0.0.0	0.0.0.0	0.0.0.0		
6	00:80:63:46:00:06	<input checked="" type="checkbox"/>	192.168.2.181	255.255.255.0	192.168.2.1		
7	00:80:63:A3:40:40	<input type="checkbox"/>	10.115.0.59	255.255.224.0	10.115.0.3		
8	00:80:63:A4:CC:40	<input type="checkbox"/>	10.115.0.81	255.255.224.0	10.115.0.3		
9	00:80:63:6E:38:4E	<input checked="" type="checkbox"/>	192.168.2.174	255.255.255.0	192.168.2.1		
10	00:80:63:18:2A:61	<input checked="" type="checkbox"/>	192.168.2.170	255.255.255.0	192.168.2.1		
11	00:80:63:A3:40:80	<input type="checkbox"/>	10.115.0.66	255.255.224.0	10.115.0.3		
12	00:80:63:A4:CC:80	<input type="checkbox"/>	10.115.0.80	255.255.224.0	10.115.0.3		
13	00:80:63:61:AC:81	<input checked="" type="checkbox"/>	192.168.2.176	255.255.255.0	192.168.2.1		
14	00:80:63:98:10:95	<input type="checkbox"/>	10.115.0.22	255.255.224.0	10.115.0.3		
15	00:80:63:61:AC:AB	<input checked="" type="checkbox"/>	192.168.2.40	255.255.255.0	192.168.2.1		
16	00:80:63:3B:5C:BD	<input checked="" type="checkbox"/>	192.168.2.178	255.255.255.0	192.168.2.1		
17	00:80:63:A3:40:C0	<input type="checkbox"/>	10.115.0.72	255.255.224.0	10.115.0.3		
18	00:80:63:8F:2C:BE	<input type="checkbox"/>	10.115.0.40	255.255.224.0	10.115.0.3		
19	00:80:63:88:38:EC	<input checked="" type="checkbox"/>	192.168.110.92	255.255.255.0	0.0.0.0		
20	00:80:63:9B:11:00	<input type="checkbox"/>	10.115.0.35	255.255.224.0	10.115.0.3		
21	00:80:63:A4:CD:00	<input type="checkbox"/>	10.115.0.77	255.255.224.0	10.115.0.3		
22	00:80:63:99:41:08	<input type="checkbox"/>	10.115.0.13	255.255.224.0	10.115.0.3		
23	00:80:63:17:35:08	<input checked="" type="checkbox"/>	192.168.2.164	255.255.255.0	192.168.2.1		
24	00:80:63:44:19:2E	<input checked="" type="checkbox"/>	10.115.5.130	255.255.224.0	10.115.0.3		

Properties [X]

MAC Address: 00:80:63:A3:40:00

Name: Power Unit 1 Switch 2

IP Configuration

IP Address: . . .

Net Mask: . . .

Default Gateway: . . .







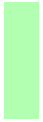
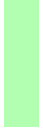



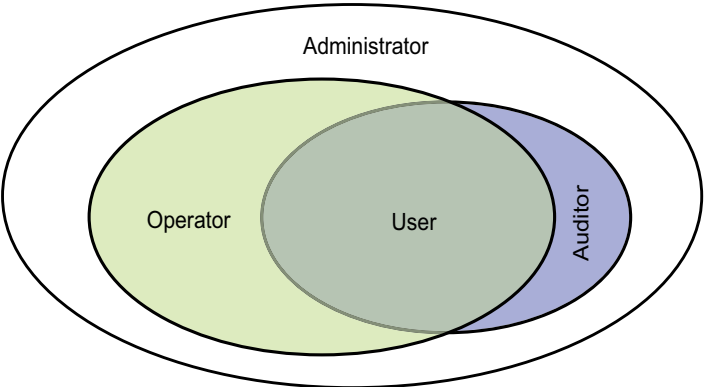







+





0
x

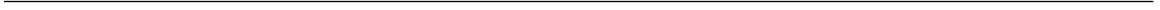
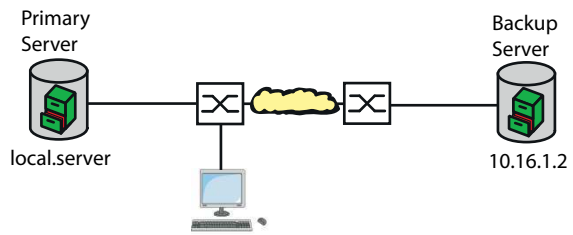



+

+

+







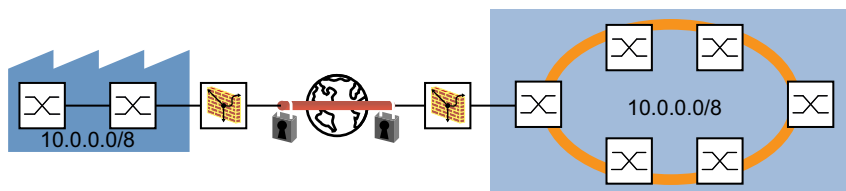



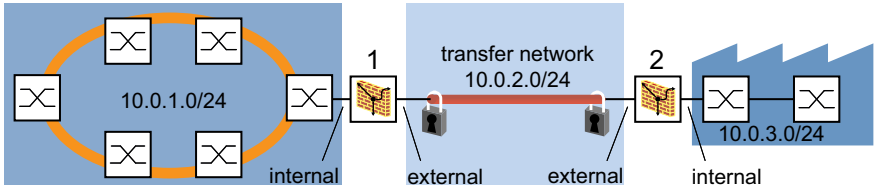









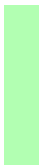



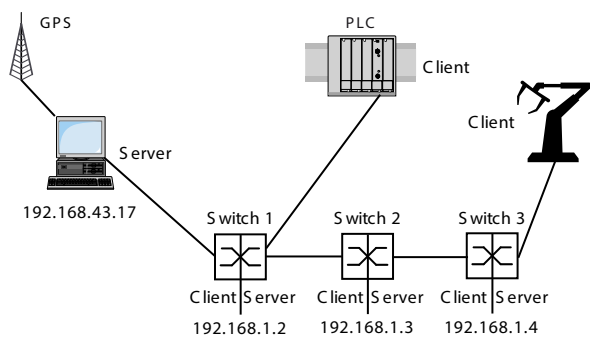



+





+







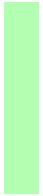

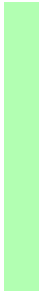

=

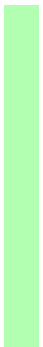

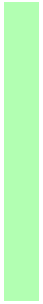











≡



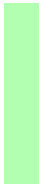













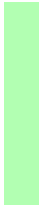



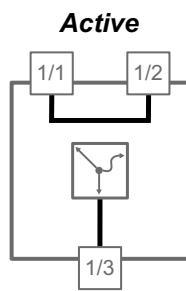
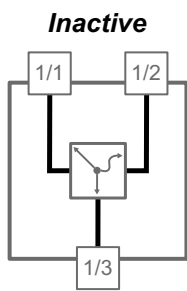





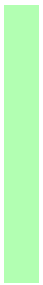



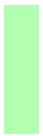
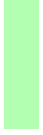





⌘ +





田+

田+

✓





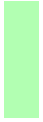

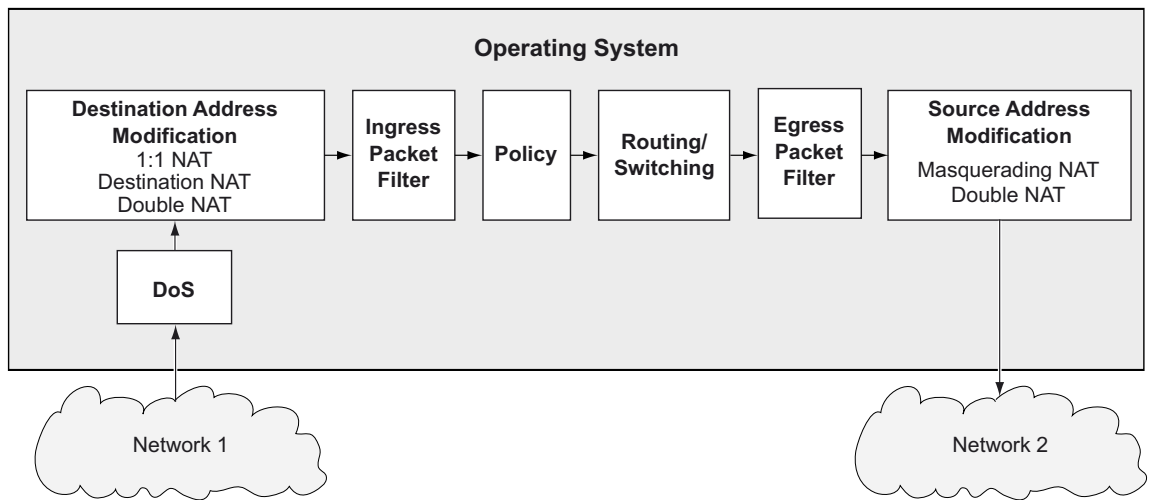



B+



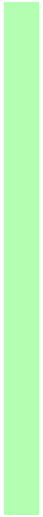



B+











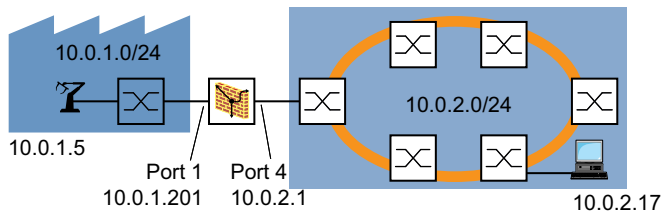







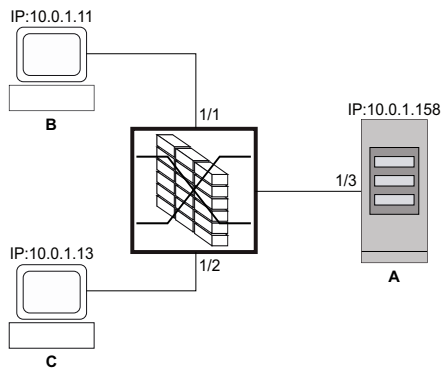





⌘ +



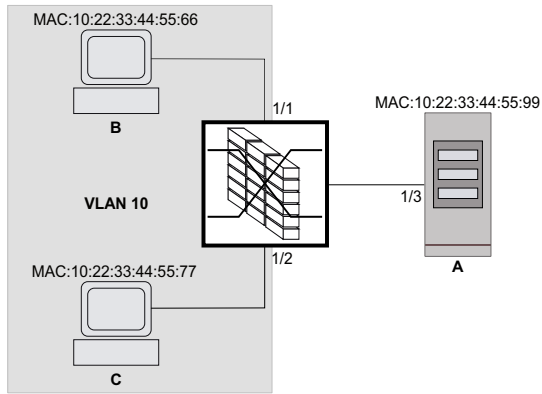





田+









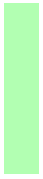
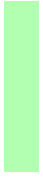



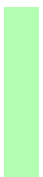
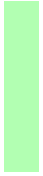



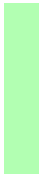
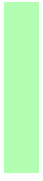





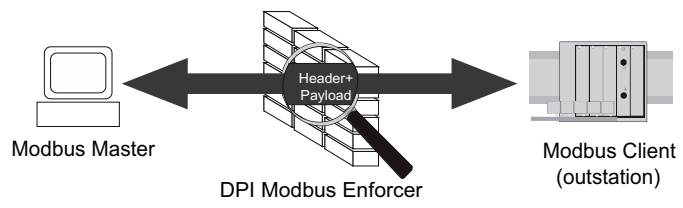



B+





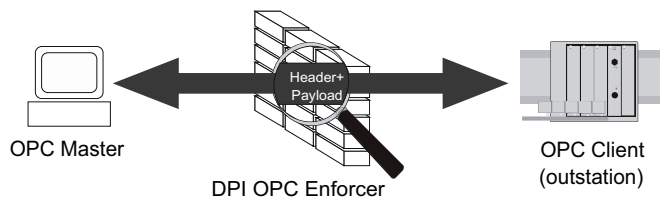



B+





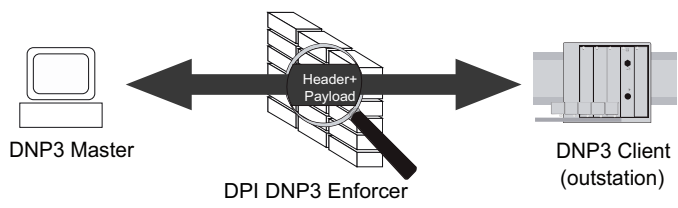



B+





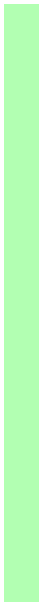
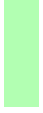

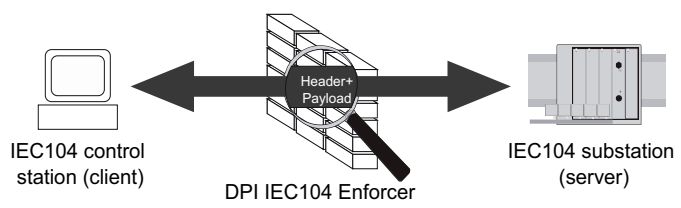



B+



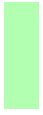



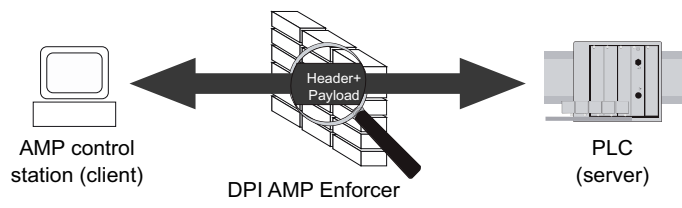



B+



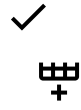
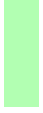



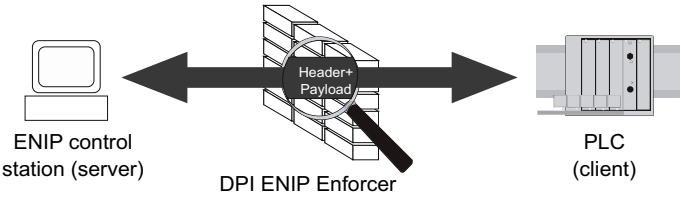



⌘+

⌘+





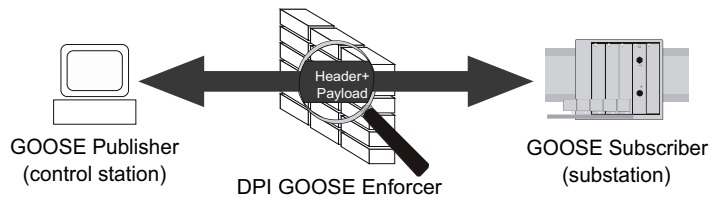







+









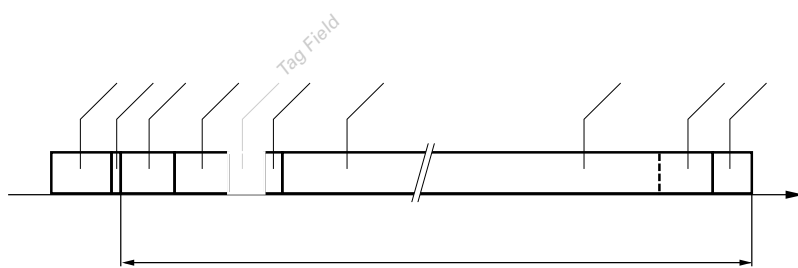

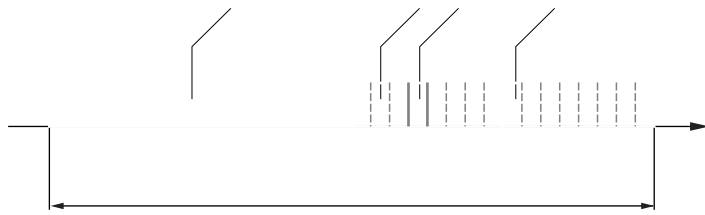

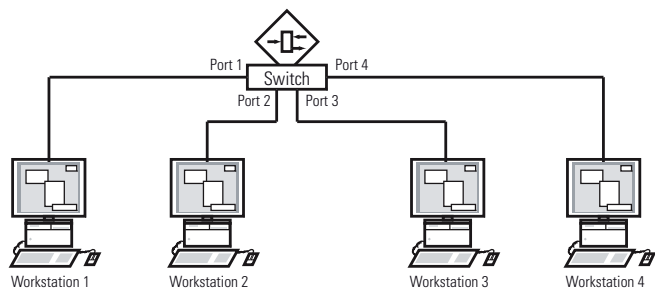





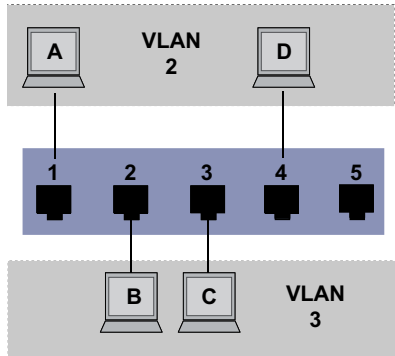



B+





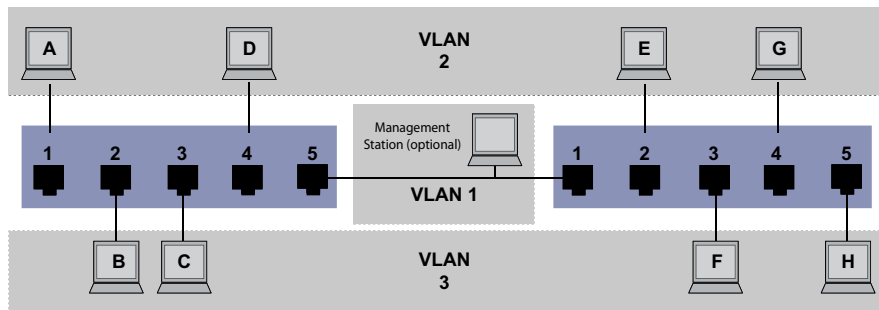

[Blue header bar]

[Lined text area 1]

[Blue header bar]

[Lined text area 2]

[Blue header bar]

[Lined text area 3]











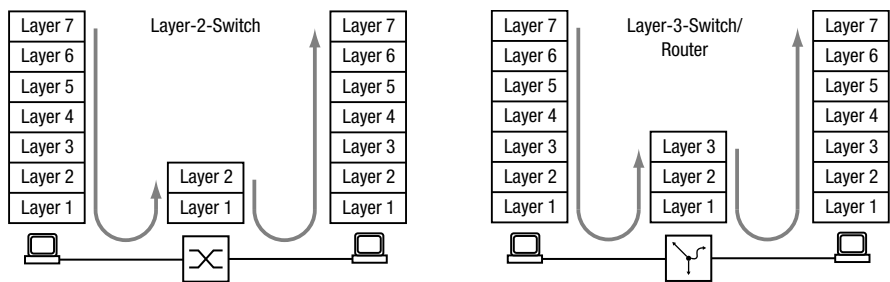

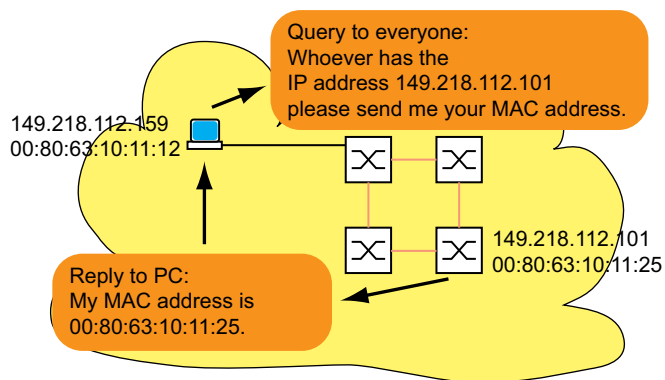

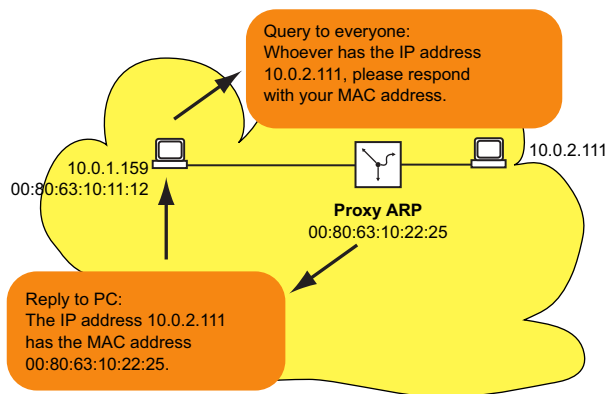
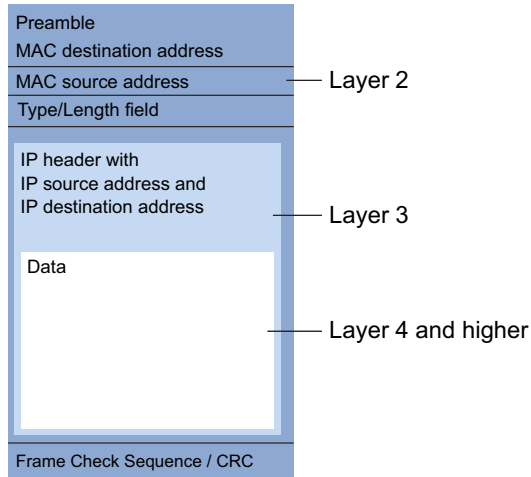

IP address, decimal	Network mask, decimal	IP address, binary
149.218.112.1	255.255.255.128	10010101 11011010 01110000 00000001
149.218.112.127		10010101 11011010 01110000 01111111
		----- 25 mask bits -----

CIDR notation: 149.218.112.0/25

└----- Mask bits

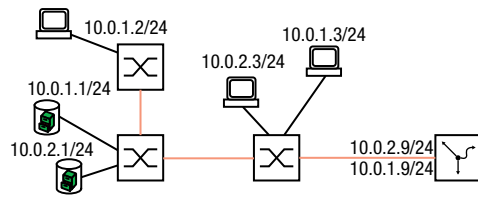

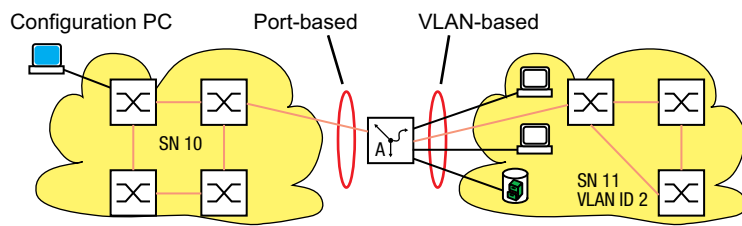

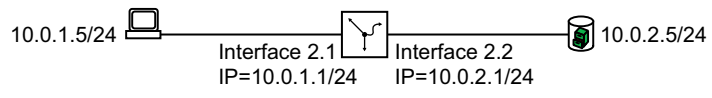

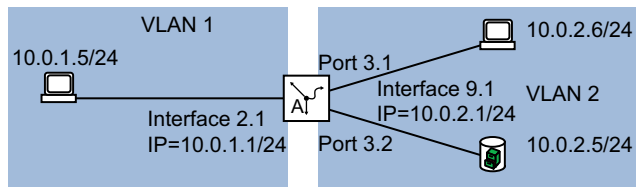



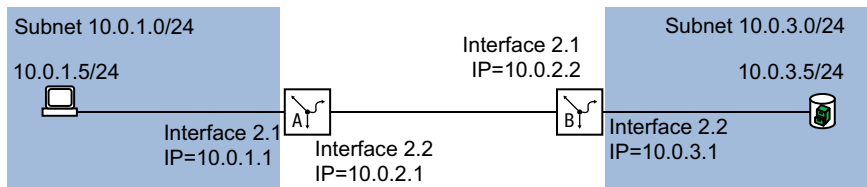

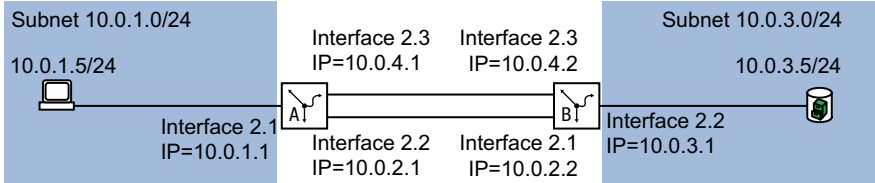



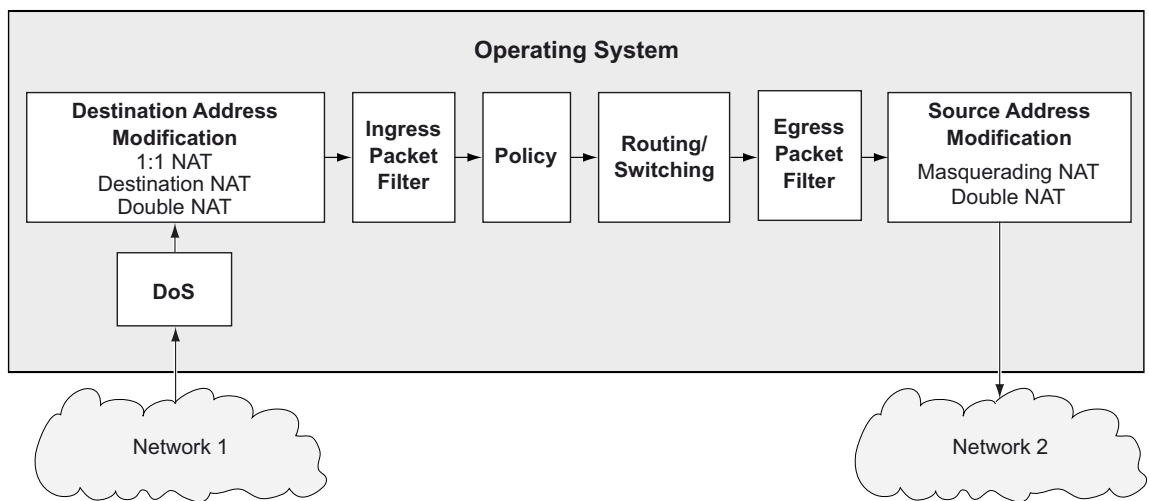

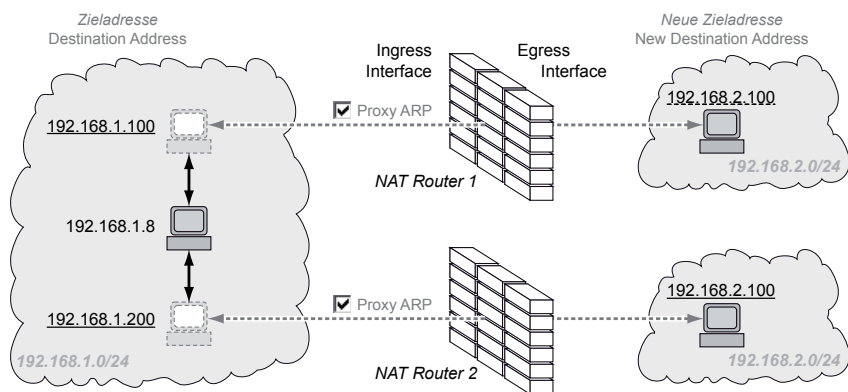
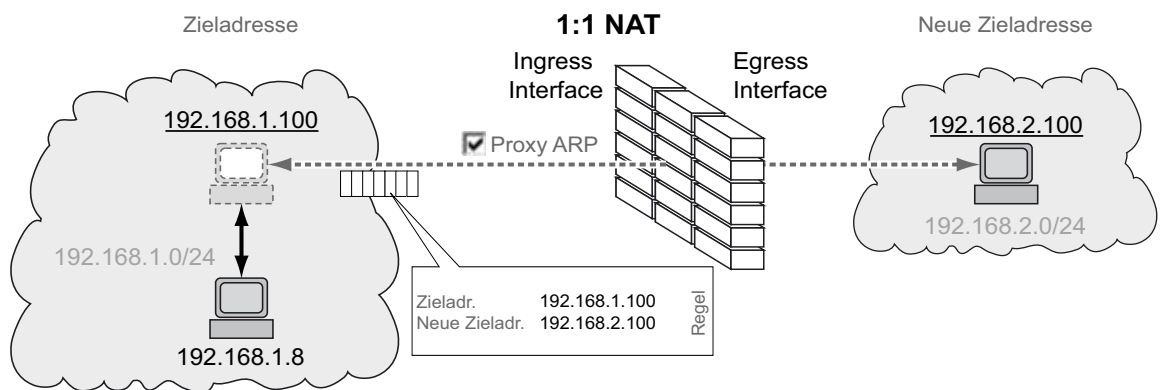



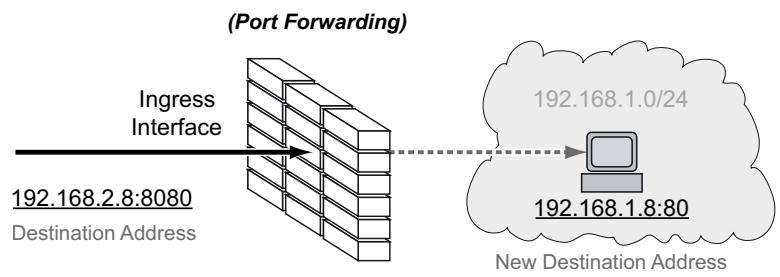
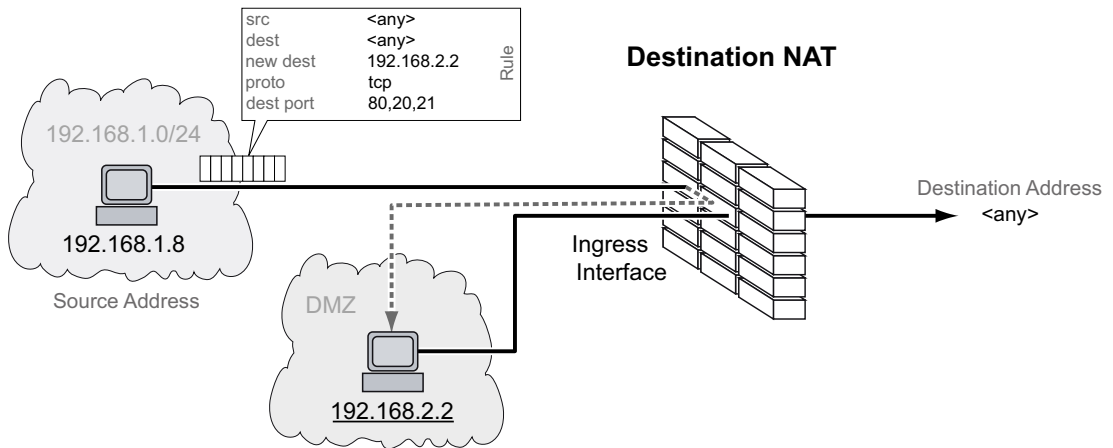





⌘ +



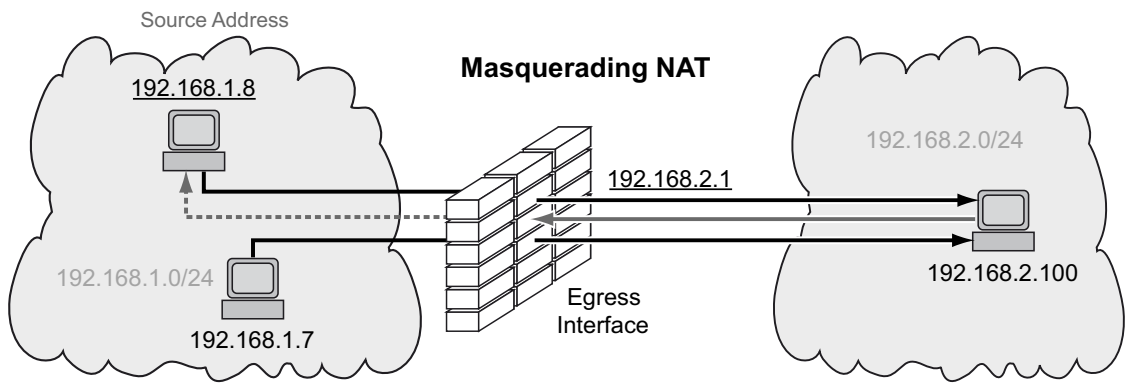

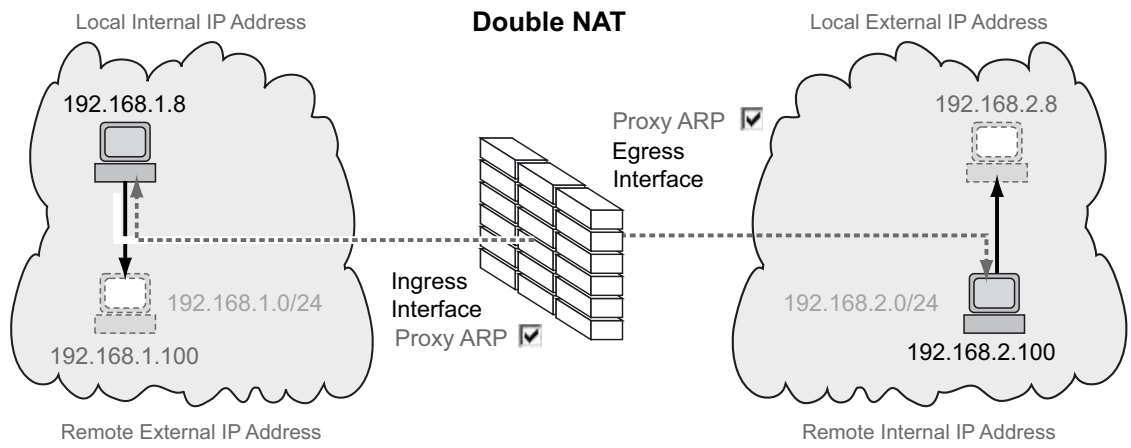

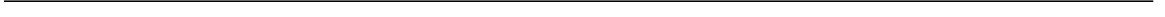





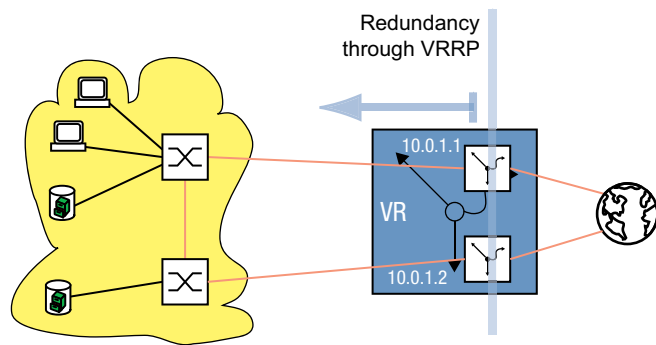

00:00:5e:00:01:xx

variable element = VRID
constant element



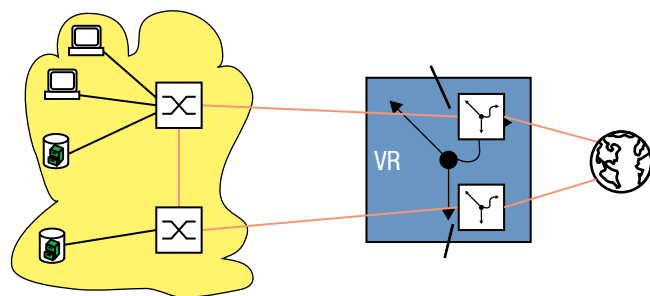
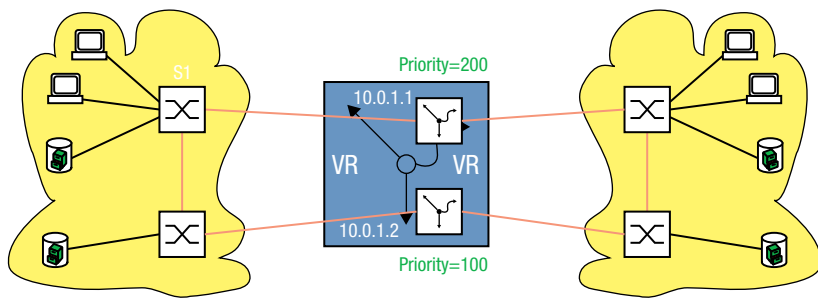





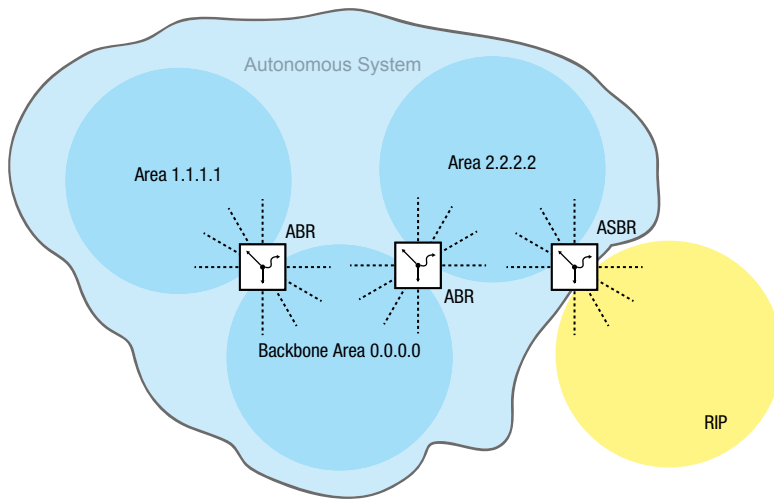

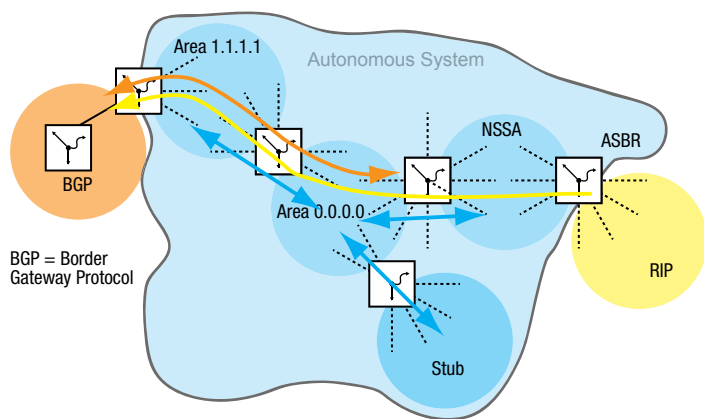

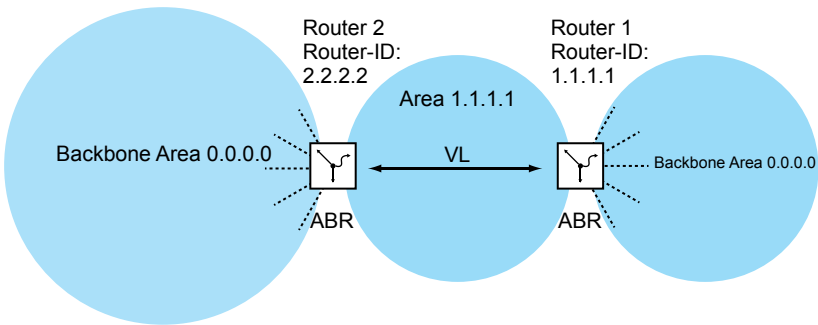
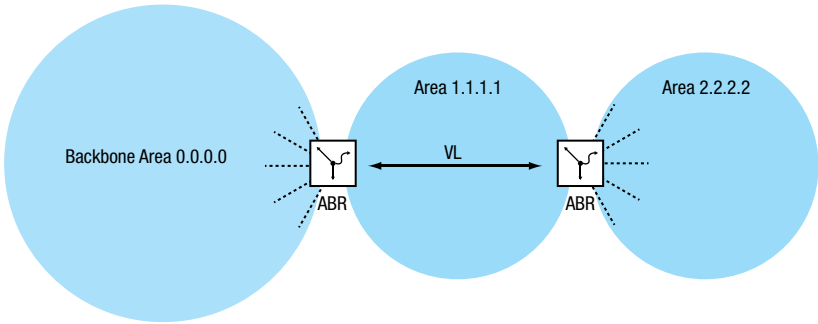

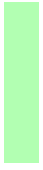

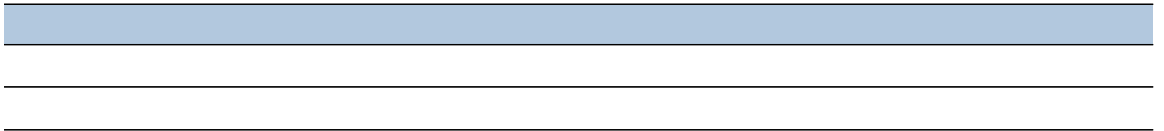
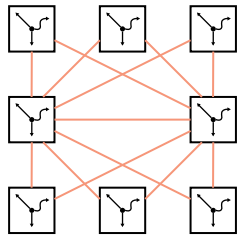





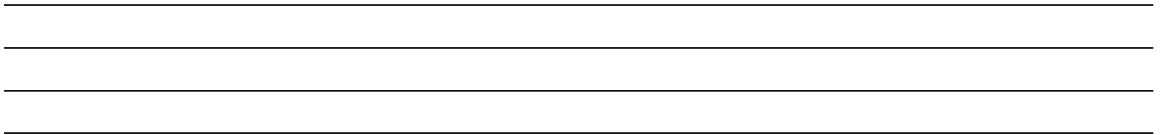

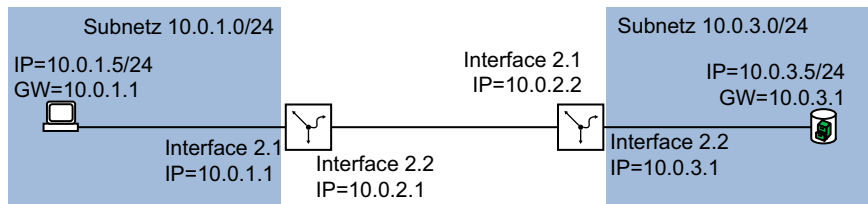





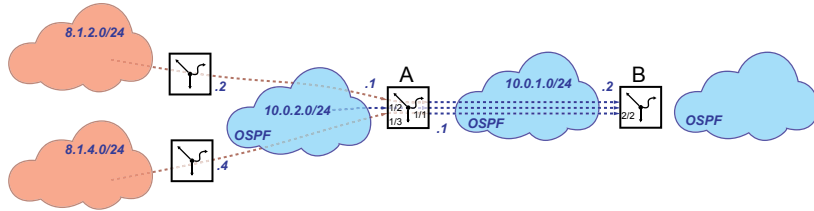



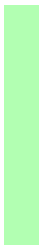
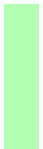
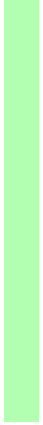
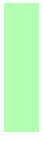

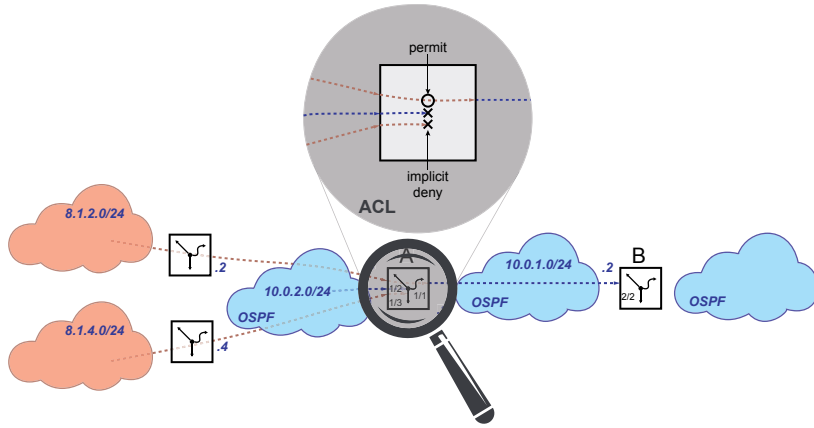



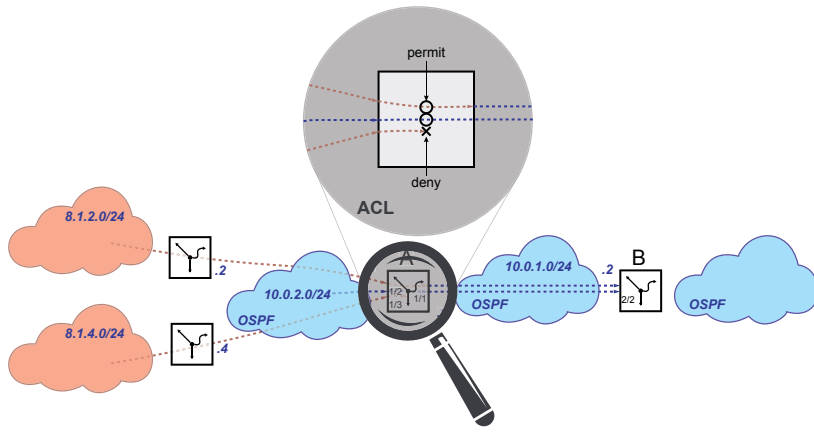

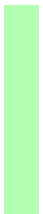
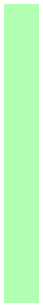
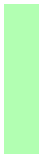







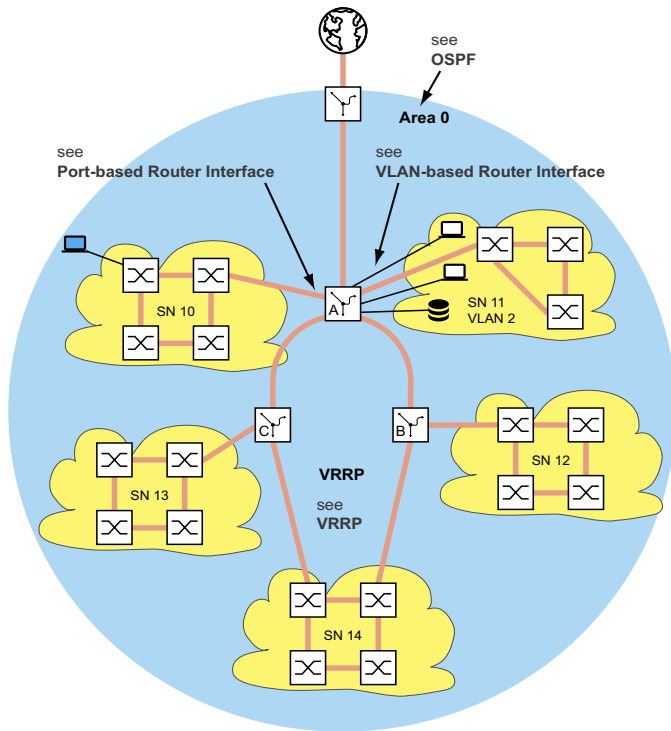

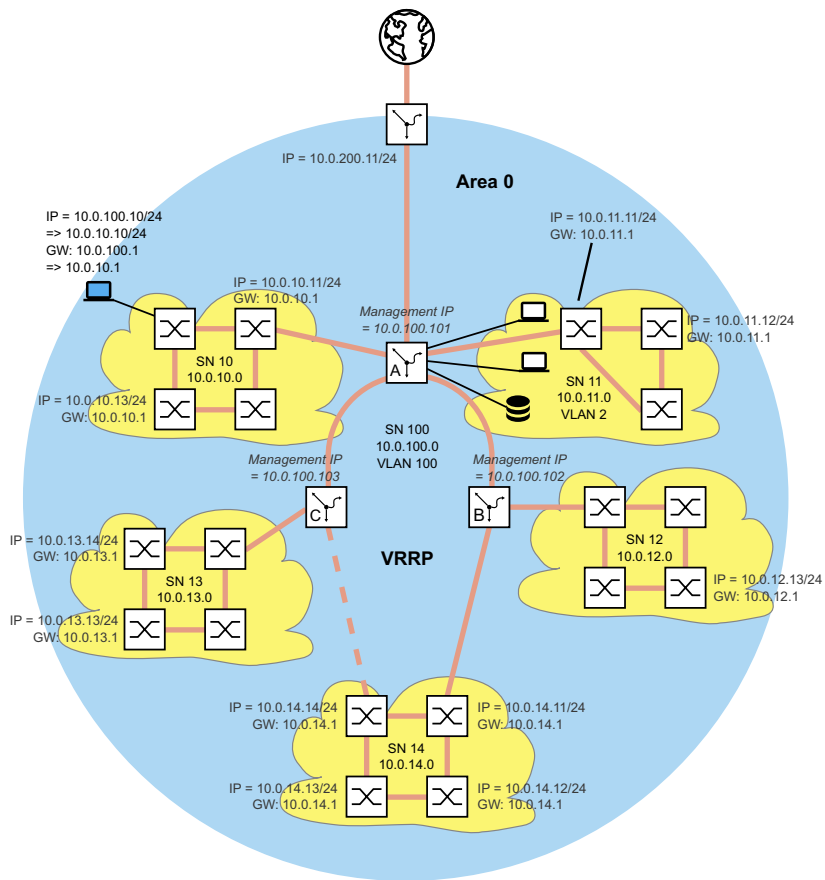

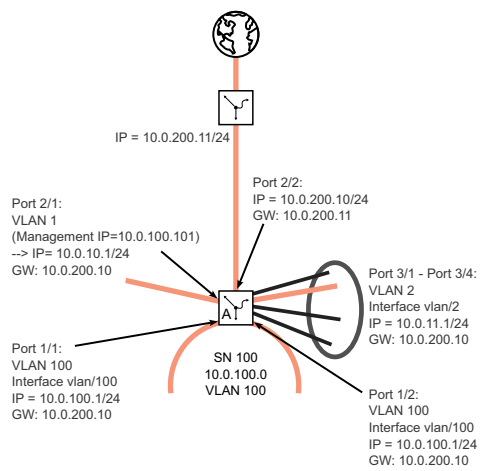

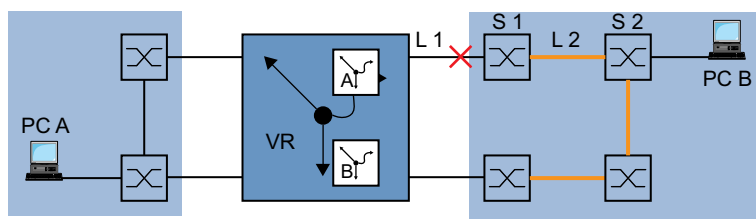

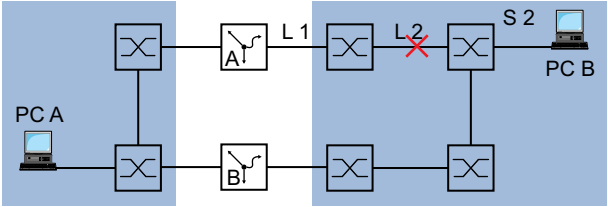



+

✓



⌘+





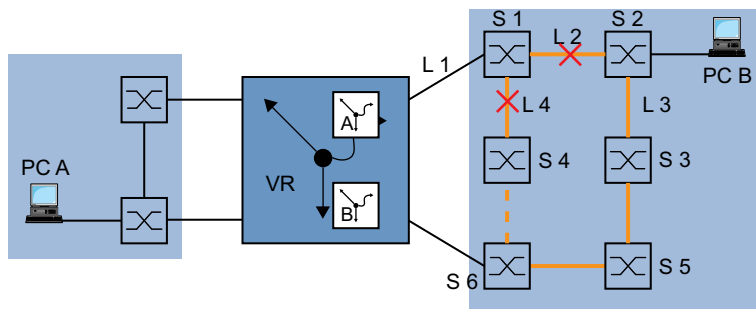

⊞
+





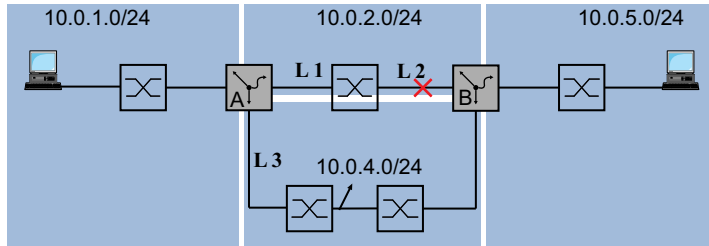

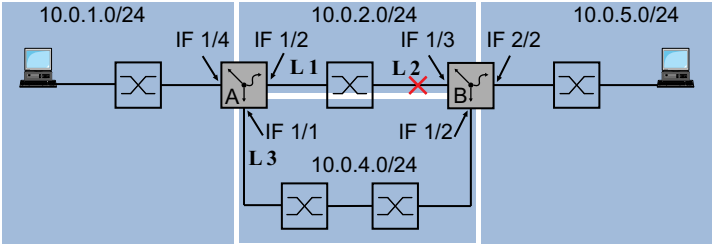

⊞
+

⊞
+





$B+$

$B+$

✓

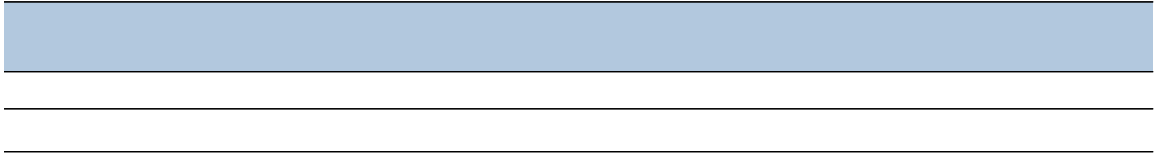



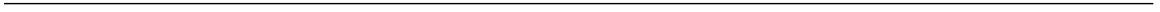
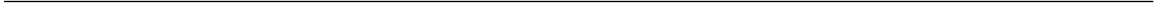



⌘ +









A series of 12 horizontal lines for writing, positioned below the blue bar.







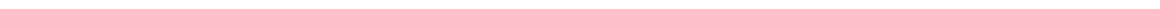
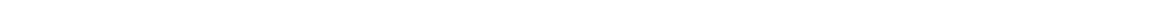
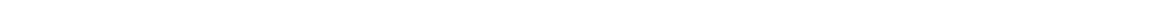
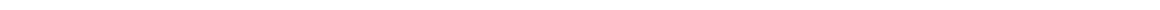
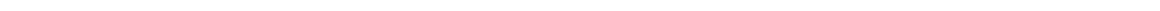
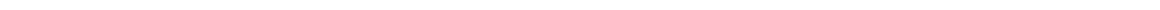
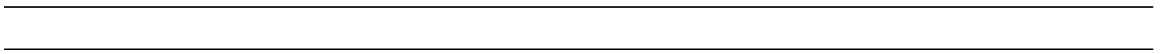

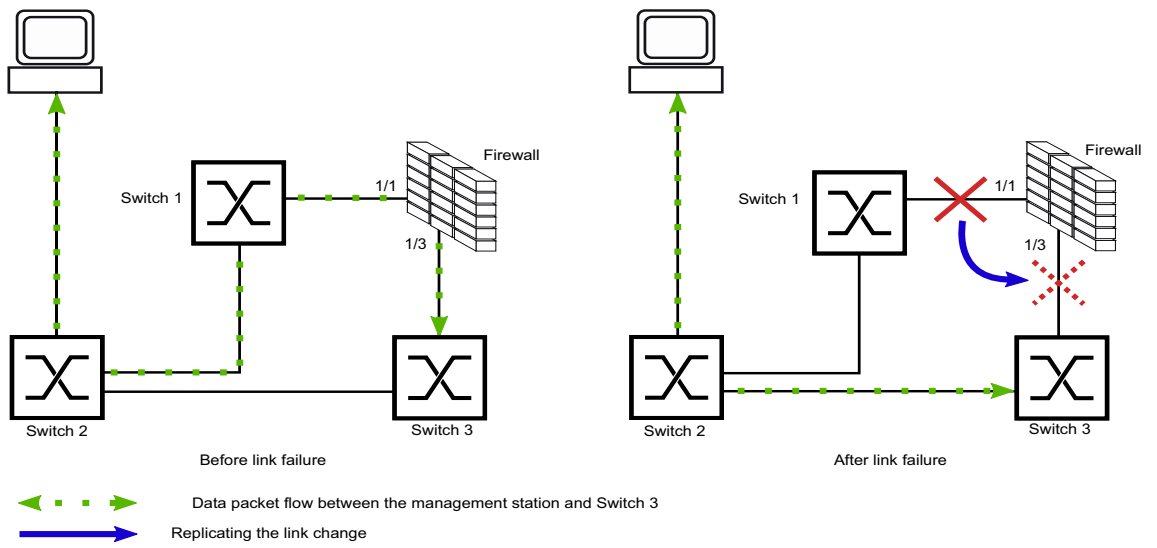

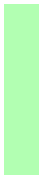











⌘ +



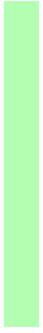

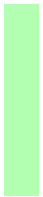
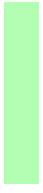

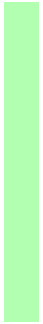



⌘ +





⌘ +





☰
+

✓

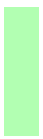

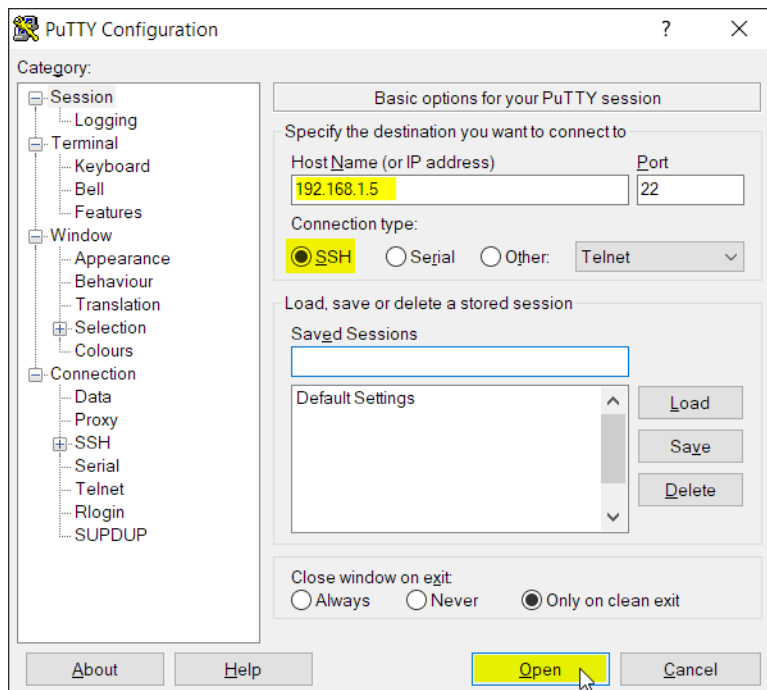

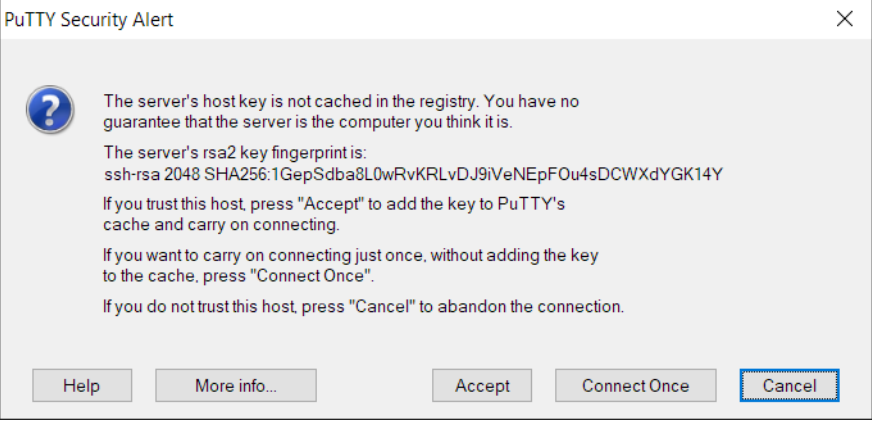

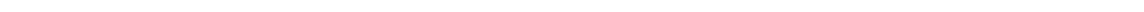





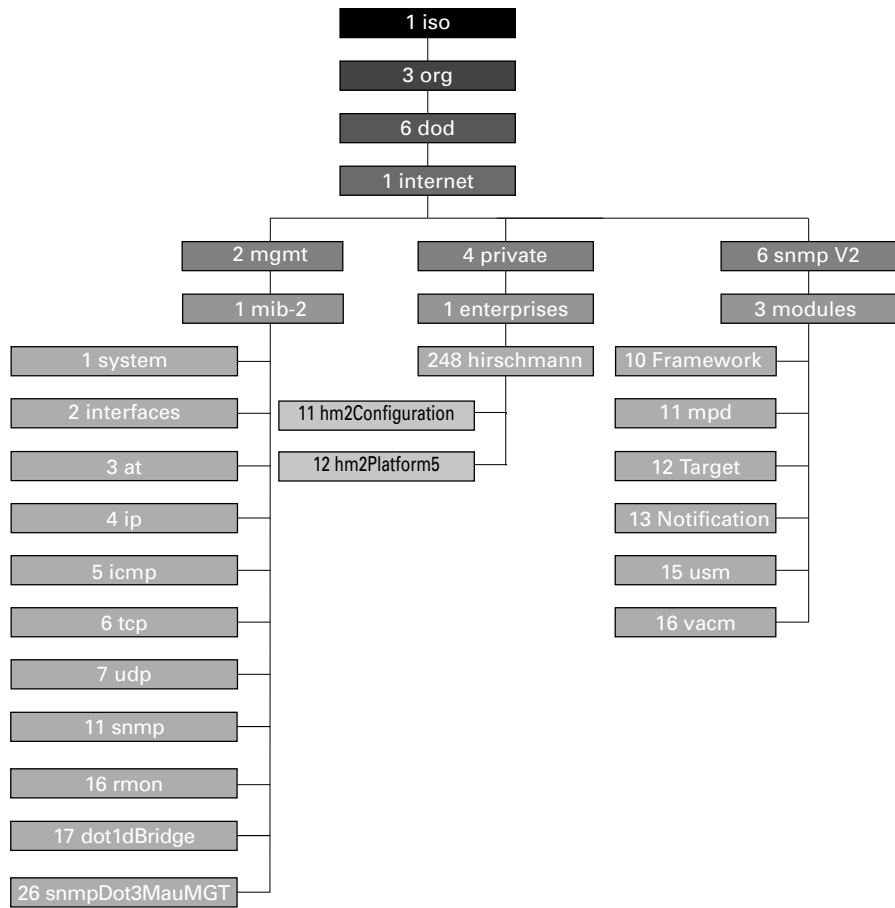











HIRSCHMANN