

Manual

EtherNet/IP

LioN-X Low Current Digital-I/O Multiprotocol:

0980 XLC 3900-121-007D-01F (16 × Input/Output)

0980 XLC 3901-121-007D-01F (16 × Input)

0980 XLC 3903-121-007D-01F (8 × Input, 8 × Output
isolated)

0980 XLC 3923-121-007D-01F (8 × Input, 8 × Output)

Contents

1 About this manual	8
1.1 General information	8
1.2 Explanation of symbols	9
1.2.1 Use of danger information	9
1.2.2 Use of general information	9
1.3 Version information	9
2 Safety instructions	10
2.1 Intended use	10
2.2 Qualified personnel	11
3 Designations and synonyms	12
4 System description	15
4.1 Device variants	16
4.2 I/O port overview	17
5 Overview of product features	21
5.1 EtherNet/IP product features	21
5.2 Integrated Web server	23
5.3 Security features	24
5.4 Other features	25

6 Assembly and wiring	26
6.1 General information	26
6.2 Outer dimensions	27
6.2.1 LioN-X Low Current Digital-I/O multi-protocol variants	27
6.2.2 Notifications	31
6.3 Port assignments	32
6.3.1 Ethernet ports, M12 socket, 4-pin, D-coded	32
6.3.2 Power supply with M12 power L-coded	33
6.3.3 I/O ports as M12 sockets	34
6.3.3.1 I/O ports	35
7 Starting operation	36
7.1 EDS file	36
7.2 MAC addresses	36
7.3 State on delivery	37
7.4 Setting network parameters	38
7.5 Setting the rotary encoding switches	38
7.5.1 EtherNet/IP selection and IP configuration via rotary encoding switches	40
7.5.2 Factory reset	42
8 Configuration EtherNet/IP	43
8.1 Assembly types	43
8.2 Connections	44
8.2.1 16 DI/DO and 8 DI/8 DO (Exclusive Owner) parameters	46
8.2.2 16 DI/DO, 8 DI/8 DO and 16 DI (Input Only) parameters	46
8.2.3 16 DI/DO, 8 DI/8 DO and 16 DI (Listen Only) parameters	47
8.2.4 Extended Diagnoses (Input Only) parameters	48

9 Configuration parameters	50
9.1 General settings	51
9.1.1 QuickConnect	52
9.1.2 Force mode lock	52
9.1.3 Web interface lock	53
9.1.4 Report U_L/U_{AUX} supply voltage fault	53
9.1.5 Report DO Fault without U_L/U_{Aux}	53
9.1.6 CIP object configuration lock	53
9.1.7 External configuration lock	53
9.2 Channel settings	55
9.2.1 IO Mapping (Ch1 .. 16)	57
9.2.2 DO Surveillance Timeout (Ch1 .. 16)	57
9.2.3 DO Failsafe (Ch1 .. 16)	57
9.2.4 DO Restart Mode (Ch1 .. 16)	58
9.2.5 DI Logic (Ch1 .. 16)	58
9.2.6 DI Filter (Ch1 .. 16)	58
9.2.7 DI Extension	58
9.2.8 Channel Mode (Ch1 .. 16)	60
10 Process data assignment	62
10.1 Consuming data image (output)	62
10.1.1 Digital output channel control	62
10.2 Producing data image (input)	63
10.2.1 Digital input channel status	63
10.2.2 General diagnostics	63
10.2.3 Sensor diagnostics	64
10.2.4 Actuator/ U_L diagnostics	64
10.3 Producing data image (Extended diagnoses)	65
10.4 Sample applications	65
10.4.1 Process data images – default configuration	65

11 Configuration and operation with Rockwell Automation Studio 5000®	67
11.1 Basic commissioning	67
12 CIP object classes	73
12.1 EtherNet/IP object classes	73
12.1.1 Identity Object (0x01)	74
12.1.2 Assembly Object (0x04)	77
12.1.3 Discrete Input Point Object (0x08)	78
12.1.4 DLR Object (0x47)	79
12.1.5 QoS Object (0x48)	81
12.1.6 TCP/IP Object (0xF5)	83
12.1.7 Ethernet Link Object (0xF6)	85
12.1.8 LLDP Management Object (0x109)	88
12.1.9 LLDP Data Table Object (0x10A)	90
12.2 Vendor specific object classes	93
12.2.1 General Settings Object (0xA0)	93
12.2.2 Channel Settings Object (0xA1)	95
12.3 Message configuration in Rockwell Automation Studio 5000®	97
13 Diagnostics processing	99
13.1 Error of the system/sensor power supply	99
13.2 Error of the actuator power supply	100
13.3 Overload/short-circuit of the I/O port sensor supply outputs	101
13.4 Overload/short circuit of the digital outputs	102
14 IIoT functionality	103
14.1 MQTT	104

14.1.1 MQTT configuration	104
14.1.2 MQTT topics	107
14.1.2.1 Base topic	107
14.1.2.2 Publish topic	110
14.1.2.3 Command topic (MQTT Subscribe)	118
14.1.3 MQTT configuration - Quick start guide	122
14.1.3.1 MQTT configuration via JSON	122
14.2 OPC UA	124
14.2.1 OPC UA configuration	124
14.2.1.1 Gateway objects	127
14.2.1.2 Ports objects	130
14.2.1.3 Channel objects	131
14.2.2 OPC UA address space	133
14.2.3 OPC UA configuration - Quick start guide	134
14.2.3.1 OPC UA configuration via JSON	134
14.3 REST API	136
14.3.1 Standard device information	136
14.3.2 Structure	137
14.3.3 Configuration and forcing	141
14.4 CoAP server	143
14.4.1 CoAP configuration	143
14.4.2 REST API access via CoAP	144
14.4.3 CoAP configuration - Quick start guide	146
14.4.3.1 CoAP configuration via JSON	146
14.5 Syslog	148
14.5.1 Syslog configuration	148
14.5.2 Syslog configuration - Quick start guide	151
14.5.2.1 Syslog configuration via JSON	151
14.6 Network Time Protocol (NTP)	153
14.6.1 NTP configuration	153
14.6.2 NTP configuration - Quick start guide	155
14.6.2.1 NTP configuration via JSON	155

15 The integrated Web server

157

15.1 LioN-X 0980 XLC... variants	158
15.1.1 The Status page	158
15.1.2 The Ports page	159
15.1.3 The System page	160
15.1.4 The User page	163

16 Technical data **164**

16.1 General	165
16.2 EtherNet/IP protocol	166
16.3 Power supply of the module electronics/sensors	167
16.4 Power supply of the actuators	169
16.5 I/O ports	169
16.5.1 Digital inputs	170
16.5.2 Digital outputs	170
16.6 LEDs	173
16.7 Data transfer times	175

17 Recycling note **177**

18 Accessories **178**

1 About this manual

1.1 General information

Download the latest version of this document at:

<http://doc.beldensolutions.com>

Please read the assembly and operating instructions in this manual carefully before starting up the devices. Keep the manual where it is accessible to all users.

The texts, figures, diagrams, and examples used in this manual are used exclusively to explain how to operate and apply the devices.

Please contact us if you have any detailed questions on installing and starting up the devices.

Belden Deutschland GmbH
Belden
Im Gewerbepark 2
D-58579 Schalksmühle
Germany

<https://my.belden.com>
<https://www.belden.com>
<https://catalog.belden.com>

1.2 Explanation of symbols

1.2.1 Use of danger information

Danger information is denoted as follows:



Danger: Means that death, serious physical injury or substantial damage to property will occur if the required safety measures are not taken.



Warning: Means that death, serious physical injury or substantial damage to property can occur if the required safety measures are not taken.



Caution: Means that minor physical injury or damage to property can occur if the required safety measures are not taken.

1.2.2 Use of general information

General information is denoted as follows:



Attention: Contains important information on the product, on how to manage the product, or on the respective section of the documentation to which your special attention is being drawn.

1.3 Version information

Version	Created	Changes
1.0	02/2026	

Table 1: Overview of manual revisions

2 Safety instructions

2.1 Intended use

The products described in this manual are decentralized I/O Devices on an Industrial Ethernet Network.

We adhere to all safety standards when developing, producing, testing, and documenting our products. When you adhere to the handling specifications and safety instructions described for the configuration, assembly, and correct operation, there should not normally be any risks for people or equipment.

The modules fulfill the requirements of the EMC guidelines (89/336/EEC, 93/68/EEC and 93/44/EEC) and the low voltage guideline (73/23/EEC).

The devices are designed to be used in the industrial sector. The industrial environment is distinguished by the fact that the consumer is not connected directly to the public low voltage network. Additional measures are required for use in residential areas or in business and commercial sectors.



Attention: This equipment may cause radio interference in residential areas. In this case the operator may be requested to carry out appropriate measures.

The proper and safe operation of this product depends on proper transportation, storage, assembly, and installation, and careful operation.

During the configuration, installation, start-up, maintenance, and testing of the devices, adhere to the safety and accident-prevention guidelines for the specific application.

Only install cables and accessories that fulfill the requirements and regulations for safety, electromagnetic compatibility, and, where applicable, telecommunication end devices, as well as the specification information. Information on which cables and accessories are permitted for the installation can be obtained from Belden Deutschland GmbH or is contained in this manual.

2.2 Qualified personnel

The configuration, installation, start-up, maintenance, and testing of the devices may only be performed by a qualified electrician who is familiar with the safety standards of the automation technology.

The personnel requirements are based on the requirement profiles described by ZVEI, VDMA, or equivalent organizations.

Only electricians who are familiar with the content of this manual are authorized to install and maintain the devices described. These are persons who

- ▶ based on their technical training, knowledge, and experience, and their knowledge of the pertinent standards, can evaluate the work to be carried out and identify any potential risks or
- ▶ based on working for several years in a related sector, have the same level of knowledge as they would have from the relevant technical training.

Only Belden Deutschland GmbH is permitted to make changes to the hardware or software of the products that go beyond the scope of this manual.



Warning: Making unqualified changes to the hardware or software, or non-adherence to the warning information contained in this manual, can result in serious personal injury or damage to equipment.



Attention: Belden Deutschland GmbH accepts no liability for any damage caused by unqualified personnel or improper use. This automatically voids the warranty.

3 Designations and synonyms

AOI	Add-On Instruction
API	Application Programming Interface
BF	Bus Fault LED
Big Endian	Data format with High-B on first place (PROFINET)
BUI	Back-Up Inconsistency (EIP diagnostics)
CC	CC-Link IE Field
Ch. A	Channel A (Pin 4) of I/O port
Ch. B	Channel B (Pin 2) of I/O port
CIP	Common Industrial Protocol (media independent protocol)
CoAP	Constrained Application Protocol
CSP+	Control & Communication System Profile Plus
DCP	Discovery and Configuration Protocol
DevCom	Device Communicating (EIP diagnostics)
DevErr	Device Error (EIP diagnostics)
DI	Digital Input
DIA	Diagnostic LED
DO	Digital Output
DIO	Digital Input/Output
DTO	Device Temperature Overrun (EIP diagnostics)
DTU	Device Temperature Underrun (EIP diagnostics)
DUT	Device under test
EIP	EtherNet/IP
ERP	Enterprise Resource Planning system
ETH	ETHERNET
FE	Functional Earth
FME	Force Mode Enabled (EIP diagnostics)
FSU	Fast Start-Up

3 Designations and synonyms

GSDML	General Station Description Markup Language
High-B	High-Byte
ICT	Invalid Cycle Time (EIP diagnostics)
IIoT	Industrial Internet of Things
ILE	Input process data Length Error (EIP diagnostics)
IME	Internal Module Error (EIP diagnostics)
I/O	Input / Output
I/O port	X1 .. X8
I/O port pin 2	Channel B of X1 .. X8
I/O port pin 4 (C/Q)	Channel A of X1 .. X8
I&M	Identification & Maintenance
JSON	JavaScript Object Notation (platform independent data format)
L+	I/O port pin 1, sensor power supply
LC	Low Current
LioN-X 60	LioN-X variants with a width of 60mm
Little Endian	Data format with Low-B on first place (EtherNet/IP)
LLDP	Link Layer Discovery Protocol
Low-B	Low-Byte
LSB	Least Significant Bit
LVA	Low Voltage Actuator Supply (EIP diagnostics)
LVS	Low Voltage System/Sensor Supply (EIP diagnostics)
MIB	Management Information Base
MP	Multi-protocol: PROFINET + EtherNet/IP + EtherCAT® + Modbus TCP (+ CC-Link IE Field Basic)
MQTT	Message Queuing Telemetry Transport (open networking protocol)
MSB	Most Significant Bit
M12	Metric thread according to DIN 13-1 with 12 mm diameter
NTP	Network Time Protocol
OLE	Output process data Length Error (EIP diagnostics)
OPC UA	Open Platform Communications Unified Architecture (platform independent, service-oriented architecture)

PLC	Programmable Logic Controller
PN	PROFINET
PWR	Power
REST	REpresentational State Transfer
RFC	Request for Comments
RPI	Requested Packet Interval
RWr	Word data input as seen from the master station (CC-Link)
RWw	Word data output as seen from the master station (CC-Link)
RX	Bit data input as seen from the master station (CC-Link)
RY	Bit data output as seen from the master station (CC-Link)
SCA	Short Circuit Actuator/ U_L/U_{AUX} (EIP diagnostics)
SCS	Short Circuit Sensor (EIP diagnostics)
SLMP	Seamless Message Protocol
SNMP	Simple Network Management Protocol
SP	Single Protocol (PROFINET, EtherNet/IP, EtherCAT®, Modbus TCP or CC-Link IE Field Basic)
SPE	Startup Parameterization Error (EIP diagnostics)
UDP	User Datagram Protocol
UDT	User-Defined Data Types
UINT8	Byte in PLC (IB, QB)
UINT16	Unsigned integer with 16 bits or word in PLC (IW, QW)
U_L	U_{Load} , supply voltage for the load circuit
UL	Underwriters Laboratories Inc. (certification company)
UTC	Coordinated Universal Time (Temps Universel Coordonné)

Table 2: Designations and synonyms

4 System description

The LioN modules function as the interface in an industrial Ethernet system: A central controller on the management level is able to communicate with the decentralized sensors and actuators on the field level. The line or ring topologies for which LioN modules can be used ensure not only reliable data communication but also significantly reduce the number of cables required and thus also the costs for installation and maintenance. They additionally enable easy and quick extension.

4.1 Device variants

The following Low Current Digital I/O device variants are available in the LioN-X family:

Article number	Product designation	Description	I/O port functionality
935715001	0980 XLC 3900-121-007D-01F	LioN-X M12-60 mm, I/O Device Multi-protocol (PN, EIP, EC, MB, CC) Security	16 x Input/Output universal
935716001	0980 XLC 3901-121-007D-01F	LioN-X M12-60 mm, I/O Device Multi-protocol (PN, EIP, EC, MB, CC) Security	16 x Input
935717001	0980 XLC 3903-121-007D-01F	LioN-X M12-60 mm, I/O Device Multi-protocol (PN, EIP, EC, MB, CC) Security	8 x Input, 8 x Output Mixmodule, galvanic isolated
935718001	0980 XLC 3923-121-007D-01F	LioN-X M12-60 mm, I/O Device Multi-protocol (PN, EIP, EC, MB, CC) Security	8 x Input, 8 x Output Mixmodule, without galvanic isolation of the outputs

Table 3: Overview of LioN-X Low Current Digital-I/O variants

4.2 I/O port overview

The following tables show the main I/O port differences of the LioN-X family. Pin 4 and Pin 2 of the I/O ports can be configured partly to Digital Input or Digital Output.

LioN-X LC 16DIO ports

Device variant	Port	Pin 1 U_S	Pin 4 / Ch. A (In/Out)		Pin 2 / Ch. B (In/Out)	
0980 XLC 3900...	Info:	–	Type 1	Supply by U_L	Type 1	Supply by U_L
	X8:	U_S (2 A in sum for X1 .. X8)	DI	DO (2 A)	DI	DO (2 A)
	X7:		DI	DO (2 A)	DI	DO (2 A)
	X6:		DI	DO (2 A)	DI	DO (2 A)
	X5:		DI	DO (2 A)	DI	DO (2 A)
	X4:		DI	DO (2 A)	DI	DO (2 A)
	X3:		DI	DO (2 A)	DI	DO (2 A)
	X2:		DI	DO (2 A)	DI	DO (2 A)
	X1:		DI	DO (2 A)	DI	DO (2 A)

Table 4: Port configuration of 0980 XLC 3900... variant

LioN-X LC 16DI ports

Device variant	Port	Pin 1 U _S	Pin 4 / Ch. A (Input)	Pin 2 / Ch. B (Input)
0980 XLC 3901...	Info:	–	Type 1	Type 1
	X8:	U _S (2 A in sum for X1 .. X8)	DI	DI
	X7:		DI	DI
	X6:		DI	DI
	X5:		DI	DI
	X4:		DI	DI
	X3:		DI	DI
	X2:		DI	DI
	X1:		DI	DI

Table 5: Port configuration of 0980 XLC 3901... variants

LioN-X LC 8DI8DO ports with galvanic isolation of the outputs

Device variant	Port	Pin 1 U _S	Pin 4 / Ch. A (In/Out)		Pin 2 / Ch. B (In/Out)	
0980 XLC 3903...	Info:	–	Type 1	Supply by U _L	Type 1	Supply by U _L
	X8:	–	–	DO (2 A)	–	DO (2 A)
	X7:	–	–	DO (2 A)	–	DO (2 A)
	X6:	–	–	DO (2 A)	–	DO (2 A)
	X5:	–	–	DO (2 A)	–	DO (2 A)
	X4:	U _S (2 A in sum for X1 .. X4)	DI	–	DI	–
	X3:		DI	–	DI	–
	X2:		DI	–	DI	–
	X1:		DI	–	DI	–

Table 6: Port configuration of 0980 XLC 3903... variants

LioN-X LC 8DI8DO ports without galvanic isolation of the outputs

Device variant	Port	Pin 1 U _S	Pin 4 / Ch. A (In/Out)		Pin 2 / Ch. B (In/Out)	
0980 XLC 3923...	Info:	–	Type 3	Supply by U _L	Type 3	Supply by U _L
	X8:	–	–	DO (2 A)	–	DO (2 A)
	X7:	–	–	DO (2 A)	–	DO (2 A)
	X6:	–	–	DO (2 A)	–	DO (2 A)
	X5:	–	–	DO (2 A)	–	DO (2 A)
	X4:	U _S (200 mA)	DI	–	DI	–
	X3:	U _S (200 mA)	DI	–	DI	–
	X2:	U _S (200 mA)	DI	–	DI	–
	X1:	U _S (200 mA)	DI	–	DI	–

Table 7: Port configuration of 0980 XLC 3923... variants

5 Overview of product features

5.1 EtherNet/IP product features

Data connection

The connection option provided by LioN-X is the widely used M12 connector with D-coding for the EtherNet/IP network.

The connectors are also color-coded to prevent the ports from being mixed up.

Data transmission rates

Featuring a transmission rate of up to 10/100 MBit/s, the EtherNet/IP devices can handle both, fast transmission of I/O data and transmission of larger volumes of data.

EtherNet/IP Adapter Device

The LioN-X Digital-I/O modules support the EtherNet/IP protocol. This allows the transmission of time sensitive process data between network components in real-time communication.

ODVA CIP specification V3.36

The LioN-X Digital-I/O modules comply with ODVA CIP specification V3.36.

Integrated switch

The integrated Ethernet switch has two EtherNet/IP ports and thus supports the establishment of a line or ring topology for the EtherNet/IP network.

DHCP/BOOTP

The supported Dynamic Host Configuration Protocol (DHCP) and the Bootstrap Protocol (BOOTP) provide mechanisms for automatic obtaining of an IP address from a server managing the devices.

Device Level Ring

The additionally implemented Device Level Ring (DLR) enables the design of a highly available network infrastructure of up to 50 DLR ring nodes. If a connection is interrupted, the LioN-X devices immediately switch to an alternative ring segment and thus ensure interruption-free operation. These DLR ring nodes are “beacon-based” according to the EtherNet/IP specification.

Diagnostic data

The devices support diagnosis flags and extended diagnostic data that can be appended to the I/O data.

EDS-based configuration and parameterization of the I/O ports

The EDS offers the option of configuring and parameterizing the I/O ports on the Master devices.

5.2 Integrated Web server

Network parameter display

Get an overview of network parameters such as the IP address, subnet mask and gateway.

Displaying diagnostics

View diagnostics via the integrated Web server.

User management

Use the integrated Web server for convenient management of all users.

5.3 Security features

Firmware signature

The official firmware update packages contain a signature which helps prevent the system against manipulated firmware updates.

Syslog

The LioN-X multi-protocol variants support the traceability of messages centrally managed and logged via Syslog.

User manager

The Web server provides a user manager to help protect the Web interface against unauthorized access. You can manage the users by groups with different access levels “Admin” or “Write”.

Default user settings:

User: admin

Password: private



Attention: Change the default settings to help protect the device against unauthorized access.

5.4 Other features

Interface protection

The devices have reverse polarity, short-circuit and overload protection for all interfaces.

For more details, see section [Port assignments](#) on page 32.

Failsafe

The devices support a failsafe function. This allows you to define the behavior of every single channel configured as an output in the case of invalid PLC data (e.g. PLC in STOP) or of lost PLC communication.

Industrial Internet of Things

LioN-X is industry 4.0 ready and supports the integration in IIoT networks via REST API and the IIoT-relevant protocols MQTT, OPC UA and CoAP.

Color-coded connectors

The colored connectors help you avoid confusion in your cabling.

IP protection classes: IP65 / IP67 / IP69K

The IP protection class describes environmental influences that the devices can be exposed to without risk and without suffering damage or causing a risk for the user.

The whole LioN-X family offers IP65, IP67 and IP69K.

6 Assembly and wiring

6.1 General information

Mount the device on a flat surface using 2 screws (M4x 25/30). The torque required here is 1 Nm. Use washers for all fastening methods as per DIN 125.



Attention: The devices have a ground connection with an M4 thread for the conduction of interference currents and the EMC immunity. This is labeled with the symbol for the ground and the designation "FE".



Attention: Use a low-impedance connection to connect the device to the reference ground. When using a grounded mounting surface, you can make the connection directly via the fixing screws.



Attention: If the mounting surface is ground-free, use a ground strap or a suitable FE line (FE = Functional Earth). Use an M4 screw to connect the ground strap or the FE line to the ground point and if possible put a washer and a toothed washer below the fixing screw.

6.2 Outer dimensions

6.2.1 Lion-X Low Current Digital-I/O multi-protocol variants

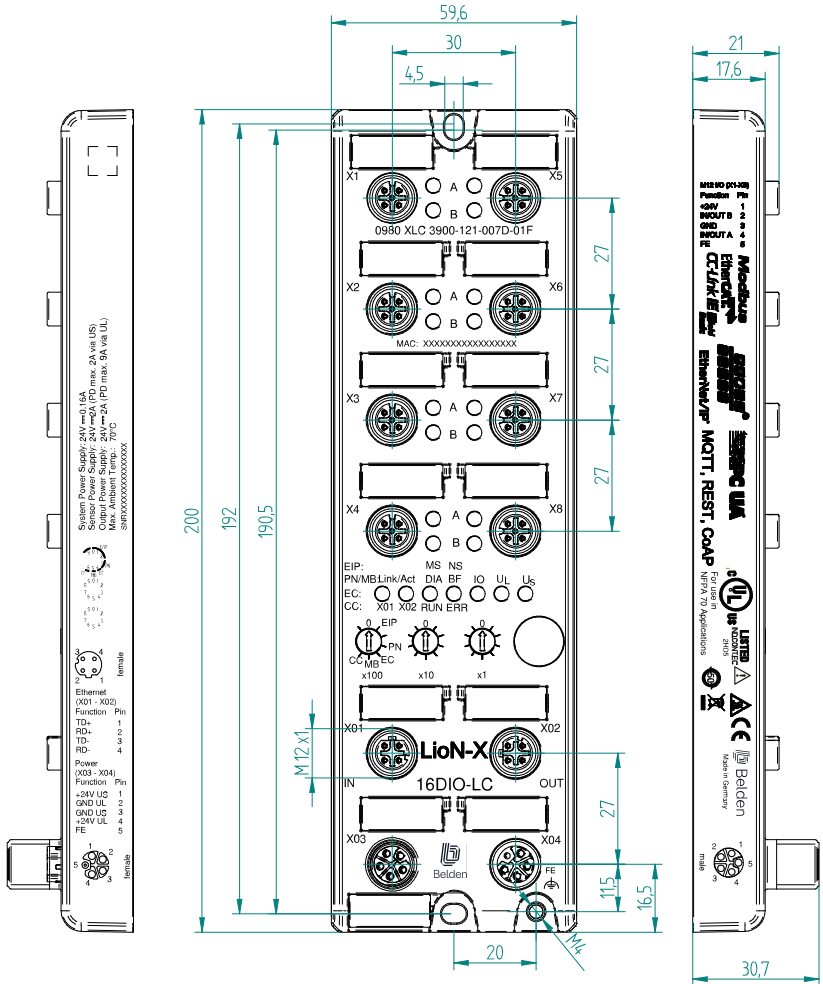

Figure 1: 0980 XLC 3900-121-007D-01F

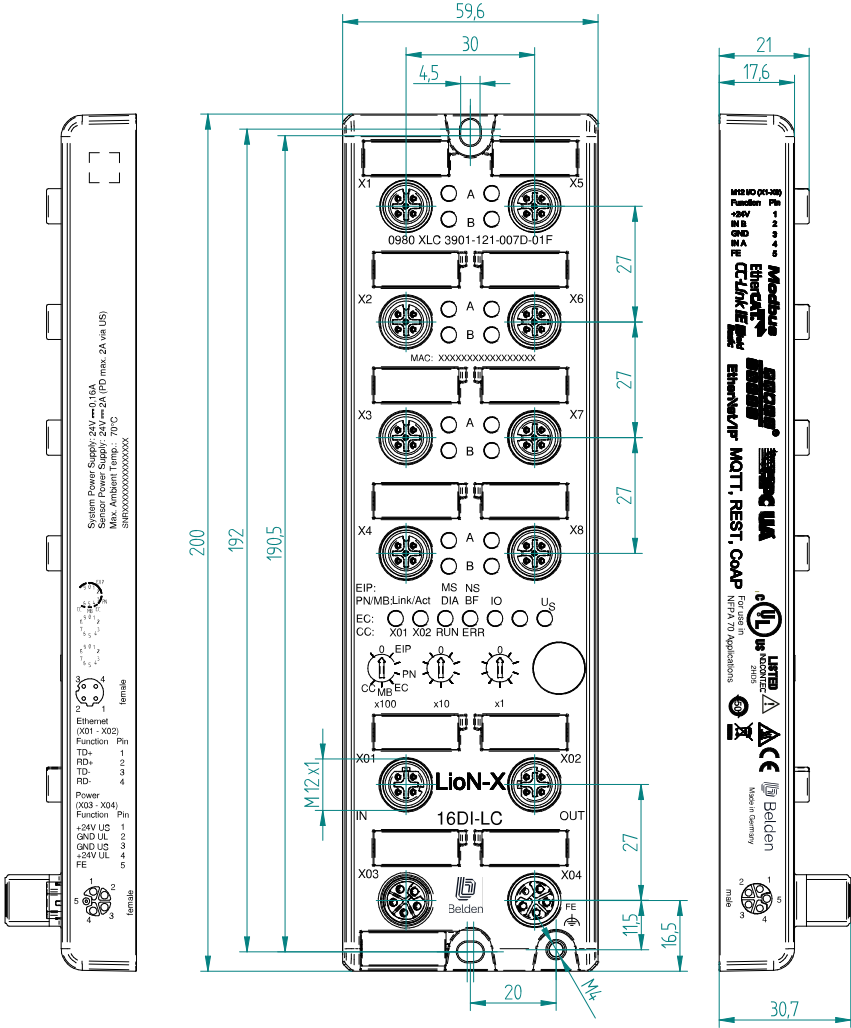

Figure 2: 0980 XLC 3901-121-007D-01F

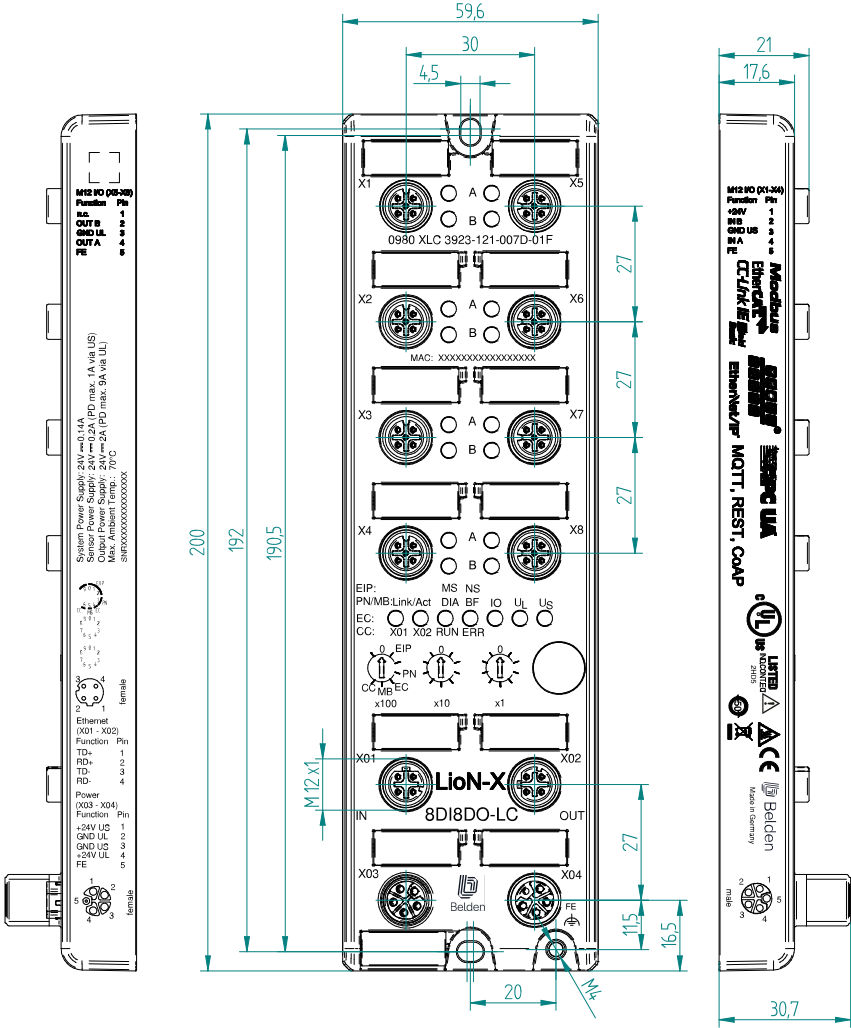

Figure 4: 0980 XLC 3923-121-007D-01F

6.2.2 Notifications



Attention:

For **UL applications**, be sure to use a UL-certified cable with a suitable evaluation to connect the devices (CYJV or PVVA). To program the control, please refer to the OEM information, and only use suitable accessories.

Only approved for interior use. Please note the maximum elevation of 2000 meters. Approved up to a maximum soiling level of 2.



Warning: Terminals, housings field-wired terminal boxes or components can exceed temperatures of +60 °C (140 °F).



Warning: For **UL applications** at a maximum ambient temperature of +70 °C (158 °F):

Use temperature-resistant cables with heat resistance up to at least +125 °C (257 °F) for all device variants.

6.3 Port assignments

All the contact arrangements shown in this chapter show the frontal view of the connection area for the connectors.

6.3.1 Ethernet ports, M12 socket, 4-pin, D-coded

Color coding: green

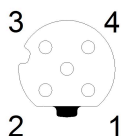

Figure 5: Schematic drawing, ports X01, X02

Port	Pin	Signal	Function
Ethernet Ports X01, X02	1	TD+	Transmit data plus
	2	RD+	Receive data plus
	3	TD-	Transmit data minus
	4	RD-	Receive data minus

Table 8: Assignment of ports X01, X02



Caution: Risk of destruction! Never connect the power supply to the data cables.

6.3.2 Power supply with M12 power L-coded

Color coding: gray

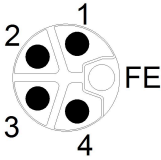

Figure 6: Schematic diagram of the M12 L-coding (connector X03 for Power In)

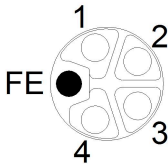

Figure 7: Schematic diagram of the M12 L-coding (socket X04 for Power Out)

Power supply	Pin	Signal	Function
	1	U_S (+24 V)	Sensor/system power supply
	2	GND_ U_L	Ground/reference potential U_L
	3	GND_ U_S	Ground/reference potential U_S
	4	U_L (+24 V)	Load supply Actuator supply
	5	FE	Functional ground

Table 9: Pin assignments ports X03 and X04



Attention: Only use power supply units for the system/sensor and actuator supply that correspond to PELV (Protective Extra Low Voltage) or SELV (Safety Extra Low Voltage). Power supplies according to EN 61558-2-6 (transformers) or EN 60950-1 (switching power supply units) fulfill these requirements.



Attention: For the input module 0980 XLC 3901..., the two contacts 1 and 5 are not required for the voltage supply of the actuator. Nevertheless, these two contacts are bridged together on the plug and socket side to enable a 5-pole forwarding of the voltage supply to a subsequent module.

6.3.3 I/O ports as M12 sockets

Color coding: black

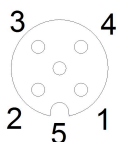

Figure 8: Schematic drawing I/O port as M12 socket

6.3.3.1 I/O ports

0980 XLC 3900...	Pin	Signal	Function
16DIO X1 .. X8	1	+24 V	power supply +24 V
	2	IN/OUT	Ch. B: Digital input or digital output
	3	GND	Ground/reference potential
	4	IN/OUT	Ch. A: Digital input or digital output
	5	FE	Functional ground
0980 XLC 3901...	Pin	Signal	Function
16DI X1 .. X8	1	+24 V	power supply +24 V
	2	IN	Ch. B: Digital input
	3	GND U _S	Ground/reference potential
	4	IN	Ch. A: Digital input
	5	FE	Functional ground
0980 XLC 3903... 0980 XLC 3923...	Pin	Signal	Function
8DI8DO X1 .. X4	1	+24 V	power supply +24 V
	2	IN	Ch. B: Digital input
	3	GND U _S	Ground/reference potential
	4	IN	Ch. A: Digital input
	5	FE	Functional ground
8DI8DO X5 .. X8	1	n.c.	–
	2	OUT	Ch. B: Digital output
	3	GND U _L	Ground/reference potential
	4	OUT	Ch. A: Digital output
	5	FE	Functional ground

Table 10: Pin assignments I/O ports

7 Starting operation

7.1 EDS file

An EDS file describes the EtherNet/IP device and can be installed in the engineering tool for the configuration of the LioN-X device. Each of the LioN-X variants requires its own EDS file. The file can be downloaded from the product pages on our online catalog: <https://catalog.belden.com>

On request, the EDS file is also sent to you by the support team.

The EDS files are grouped together in an archive file named **EDS-V3.36.1-BeldenDeutschland-XXX-yyyymmdd.eds**.

yyyymmdd stands for the date on which the file was issued.

Download this file and unpack it.

Install the EDS file for the respective device variant by using the hardware or network configuration tool of your controller manufacturer.

In Rockwell Automation Studio 5000®, install the files with the *EDS Hardware Installation Tool*.

The LioN-X and LioN-Xlight variants are then available in the hardware catalog as *Communications Adapter*.

7.2 MAC addresses

Every device has three unique assigned MAC addresses that cannot be changed by the user. The first assigned MAC address is printed onto the device.

7.3 State on delivery

EtherNet/IP parameters in state on delivery or after a factory reset:

Network mode:	DHCP
Static IP address:	192.168.1.XXX (XXX = rotary switch position or last stored data)
Subnet mask:	255.255.255.0
Gateway address:	0.0.0.0
Device designations:	0980 XLC 3900-121-007D-01F 0980 XLC 3901-121-007D-01F 0980 XLC 3903-121-007D-01F 0980 XLC 3923-121-007D-01F
Vendor code:	21
Product type:	12 (Communications Adapter)

7.4 Setting network parameters

There are multiple ways to configure the network parameters. By default, DHCP is enabled and the network parameters are requested by DHCP requests to a server. DHCP supported options are:

- ▶ Hostname (Option 12): Can be set via Web interface, REST API and CIP object 0xF5. The maximum number of characters supported is 32.
- ▶ Client Id (Option 61): Can be set via Web interface and REST API. The maximum number of characters supported is 32.

If you want to request the network parameters with BOOTP requests, you must activate the BOOTP function through the Web interface or the TCP/IP interface object (CIP Class ID 0xF5, attribute 3 (0x03)). It is also possible to set static network parameters via this CIP object.

7.5 Setting the rotary encoding switches

The following LioN-X variants support multi-protocol application for the protocols EtherNet/IP (E/IP), PROFINET (P), EtherCAT® (EC), Modbus TCP (MB) and CC-Link IE Field Basic (CC):

- ▶ 0980 XLC 3900-121-007D-01F
- ▶ 0980 XLC 3901-121-007D-01F
- ▶ 0980 XLC 3903-121-007D-01F
- ▶ 0980 XLC 3923-121-007D-01F



Caution: Risk of device damage due to corrupt device memory

Any interruption of the power supply to the device during and after protocol selection can lead to a corrupt device memory.

After selecting a protocol followed by a restart of the device, the new protocol is initialized. This can take up to 15 seconds. During this time the device is not usable and the LED indicators are out of function. When the protocol change is complete, the LED indicators return to normal operation and the device can be used again.

- ▶ Make sure that the power supply is maintained during the entire process.

The LioN-X multi-protocol variants allow you to select different protocols for communication within an industrial Ethernet system. In this way Digital I/O devices with multi-protocol function can be integrated into different networks without it being necessary to purchase products specific for each protocol. This technology also gives you the option to use the same I/O Device in different environments.

Using rotary encoding switches at the lower front of the devices, you can easily and conveniently set both the protocol and the address of the device, if the protocol to be used supports this. Once you have made a protocol selection and started the cyclical communication, the device stores this setting permanently and uses the selected protocol from this point on. To use another supported protocol with this device, perform a factory reset.

The multi-protocol devices have a total of three rotary encoding switches. With the first rotary encoding switch (x100) you set the protocol by using the corresponding switch position. Additionally, x100 is used to set the third last digit of the IP address for EIP.

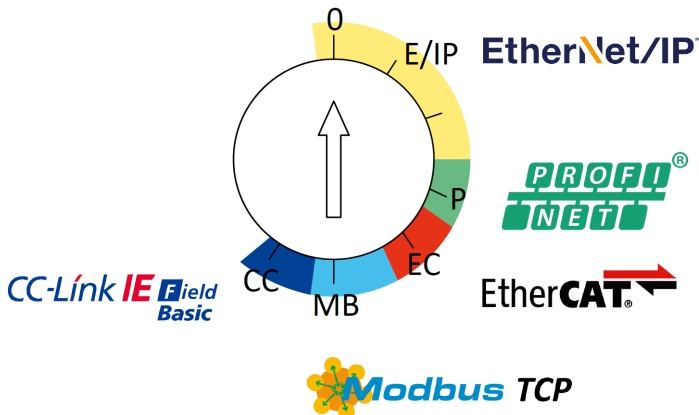

With the other rotary encoding switches (x10 / x1), you set the last two digits of the IP address when you are using EtherNet/IP, Modbus TCP or CC-Link IE Field Basic.

Protocol	x100	x10	x1
EtherNet/IP	0-2	0-9	0-9
PROFINET	P	–	–
EtherCAT®	EC	–	–
Modbus TCP	MB	0-9	0-9
CC-Link IE Field	CC	0-9	0-9

Table 11: Assignment of the rotary encoding switches for each protocol

The setting you make to select a protocol is described detailed in the protocol-specific sections.

In delivery state no protocol settings are stored in the device. In this case only the desired protocol has to be chosen. To take over a changed rotary encoding switch setting (protocol setting), a power cycle or “Reset” from the Web interface is necessary.

Once you have set the protocol using the rotary encoding switches, the device stores this setting when it starts in cyclic communication. Changing the protocol using the rotary encoding switch is no longer possible after this point. The device will always start using the stored protocol from that point on. The IP address can be changed depending on the selected protocol.

To change the protocol, carry out a factory reset. In this way you restore the factory settings of the respective device. How you perform the factory reset for your device is described in chapter [Factory reset](#) on page 42.

7.5.1 EtherNet/IP selection and IP configuration via rotary encoding switches

The EtherNet/IP protocol can be selected by the first rotary encoding switch (x100) with a value between 0 – 2.

Use all three rotary encoding switches on the front of the device to set the last octet of the static IP address. The first three octets of the IP address are set by default to 192.168.1.

Each rotary encoding switch in the EtherNet/IP setting is assigned to one decimal digit, so that you can configure a number between 0 – 299. During start-up, the position of the rotary encoding switches is typically read within one time cycle.

For example, the rotary encoding switch setting 2 (x100), 1 (x10) and 0 (x1) is interpreted by default as the IP address 192.168.1.210.

Rotary encoding switch setting	Function
000 (state on delivery, default setting)	On delivery, the DHCP function is enabled. The network parameters are requested by DHCP requests to a server. If you want to request the network parameters with BOOTP requests, you must activate the BOOTP function through the Web server or the TCP/IP interface object (CIP Class ID 0xF5, attribute 3 (0x03)). The network parameters are not saved automatically, but the integrated Web server can be used to save them.
000 (network parameters already saved)	The network parameters last saved are used (IP address, subnet mask, gateway address, DHCP on/off, BOOTP on/off).
001 ... 254	The last 3 digits of the saved or preset IP address are overwritten by the setting of the rotary encoding switches. DHCP or BOOTP are disabled if necessary, and the device will start up with a static IP address.
255 ... 298	The network parameters are requested through DHCP or BOOTP but are not saved.
299	The factory default setting of the IP address (192.168.001.001) is used.
979	The device performs a reset to the factory settings. The network parameters are also reset to the default values. Communication is not possible in this operation mode.

Table 12: Setting options of the rotary encoding switches for EtherNet/IP

7.5.2 Factory reset

A factory reset restores the original factory settings and thus resets the changes and settings you have made up to that point. It also resets the protocol selection. To perform a factory reset, set the first rotary encoding switch (x100) to 9, the second (x10) to 7, and the third (x1) also to 9.

Afterwards perform a power cycle and wait 10 seconds due to internal memory write processes.

During the factory reset, the U_S LED is blinking red. After the internal memory write processes have finished, the U_S LED returns to display static green or red light, in dependency of the actual U_S voltage.

	x100	x10	x1
Factory Reset	9	7	9

Follow the steps from section [Setting the rotary encoding switches](#) on page 38 again to select a new protocol.

For performing a factory reset via software configuration, see chapter [OPC UA configuration](#) on page 124 and the configuration section.

8 Configuration EtherNet/IP

The devices support *Implicit Messaging* and *Explicit Messaging* for the EtherNet/IP communication. I/O process data is transferred cyclically via the assembly object connection using *Implicit Messaging*.

Non-critical low priority data, configuration settings and diagnostic data can be exchanged via acyclic messages using *Explicit Messaging*. The exchange is done via EtherNet/IP and vendor specific object classes. For more details on object classes, see chapter [CIP object classes](#) on page 73.

8.1 Assembly types

The Lion-X devices support different assembly types which are defined as follows:

Assembly ID	Assembly Name	Size	Payload
130	Output Connection Point Assembly	4 Byte (16DIO, 8DI//DO)	Consuming Data Image
131	Input Connection Point Assembly	8 Byte (16DIO, 8DI//DO) 6 Byte (16DI)	Producing Data Image
132	Input Connection Point Assembly with extended diagnoses	4 Byte (16DIO) 4 Byte (8DI//DO) 2 Byte (16DI)	Extended Diagnoses Image
140	Configuration Assembly	208 Byte	Module Configuration Data

The *Consuming Data Image* and the *Producing Data Image* have fixed sizes which depend on the connection. The general input and output process data sizes of each connection can be configured in the engineering tool.

The contents of the *Consuming Data Image* and the *Producing Data Image* are specified in chapter [Process data assignment](#) on page 62.

The *Module Configuration Data* is defined in chapter [Configuration parameters](#) on page 50.

8.2 Connections

The LioN-X I/O modules support different connection types which are defined as follows:

Connection name	Connection type	Output connection point assembly	Output data size	Input connection point assembly	Input data size	Configuration assembly	Configuration data size
16 DI/DO (Exclusive Owner)	Exclusive Owner	130	4 Byte	131	8 Byte	140	0 or 208 Byte
8 DI/8 DO (Exclusive Owner)	Exclusive Owner	130	4 Byte	131	8 Byte	140	0 or 208 Byte
16 DI/DO (Input Only)	Input Only	193	0 Byte	131	8 Byte	140	0 or 208 Byte
8 DI/8 DO (Input Only)	Input Only	193	0 Byte	131	8 Byte	140	0 or 208 Byte
16 DI (Input Only)	Input Only	193	0 Byte	131	6 Byte	140	0 or 208 Byte
16 DI/DO (Listen Only)	Listen Only	192	0 Byte	131	8 Byte	n/a	0 Byte
8 DI/8 DO (Listen Only)	Listen Only	192	0 Byte	131	8 Byte	n/a	0 Byte
16 DI (Listen Only)	Listen Only	192	0 Byte	131	6 Byte	n/a	0 Byte
Extended Diagnoses (Input Only)	Input Only	193	0 Byte	132	4 Byte (16 DIO, 8 DI/8 DO) 2 Byte (16 DI)	140	0 Byte

The general input and output process data sizes of each connection are fixed.

Some engineering tools require the immediate configuration of the connection parameters. For the configuration use the parameters listed in the following chapters.

8.2.1 16 DI/DO and 8 DI/8 DO (Exclusive Owner) parameters

Connection properties	
Connection name	16 DI/DO (Exclusive Owner) 8 DI/8 DO (Exclusive Owner)
Application type	Exclusive Owner
Trigger mode	Cyclic
RPI	min. 1 ms

Connection parameters (O->T)	
Real time transfer format	32 Bit Run/Idle Header
Connection type	POINT2POINT
Assembly ID	130
Data size	4 Byte
Data type	INT (2 Byte)

Connection parameters (T->O)	
Real time transfer format	Pure data and modeless
Connection type	MULTICAST, POINT2POINT
Assembly ID	131
Data size	8 Byte
Data type	INT (2 Byte)

8.2.2 16 DI/DO, 8 DI/8 DO and 16 DI (Input Only) parameters

Connection properties	
Connection name	16 DI/DO (Input Only) 8 DI/8 DO (Input Only) 16 DI (Input Only)
Application type	Input Only

Connection properties	
Trigger mode	Cyclic
RPI	min. 1 ms

Connection parameters (O->T)	
Real time transfer format	Heartbeat
Connection type	POINT2POINT
Assembly ID	193
Data size	0 Byte
Data type	INT (2 Byte)

Connection parameters (T->O)	
Real time transfer format	Pure data and modeless
Connection type	MULTICAST
Assembly ID	131
Data size	8 Byte 6 Byte (16 DI)
Data type	INT (2 Byte)

8.2.3 16 DI/DO, 8 DI/8 DO and 16 DI (Listen Only) parameters

Connection properties	
Connection name	16 DI/DO (Listen Only) 8 DI/8 DO (Listen Only) 16 DI (Listen Only)
Application type	Listen Only
Trigger mode	Cyclic
RPI	min. 1 ms

Connection parameters (O->T)	
Real time transfer format	Heartbeat
Connection type	POINT2POINT
Assembly ID	192
Data size	0 Byte
Data type	INT (2 Byte)

Connection parameters (T->O)	
Real time transfer format	Pure data and modeless
Connection type	MULTICAST
Assembly ID	131
Data size	8 Byte 6 Byte (16 DI)
Data type	INT (2 Byte)

8.2.4 Extended Diagnoses (Input Only) parameters

Connection properties	
Connection name	Extended Diagnoses (Input Only)
Application type	Input Only
Trigger mode	Cyclic
RPI	min. 1 ms

Connection parameters (O->T)	
Real time transfer format	Heartbeat
Connection type	POINT2POINT
Assembly ID	192
Data size	0 Byte
Data type	INT (2 Byte)

Connection parameters (T->O)	
Real time transfer format	Pure data and modeless
Connection type	MULTICAST
Assembly ID	131
Data size	4 Byte (16 DI/DO, 8 DI/8 DO) 2 Byte (16 DI)
Data type	INT (36 Byte)

9 Configuration parameters

Parameters of the LioN-X device can be configured via the configuration assembly, CIP object classes, Web server or IIoT protocols. A configuration assembly is sent when an *Exclusive Owner* connection is established. They are optional in this assembly. However, when sending, all existing parameters will be overwritten by this data. Therefore, the content of the configuration assembly has the highest valence.

To avoid parameter overwriting by CIP object classes, Web server or IIoT protocols during operation, some lock parameters can be enabled in the PLC configuration respectively configuration assembly.

Certain configuration parameters apply only to Digital Outputs or only to Digital Inputs. For these to be effective, the corresponding channel must have output or input functionality and must also be configured accordingly.

Configuration parameter	Applicable for channel configuration (port mode)
DO Surveillance Timeout	DIO, DO (parameter only applicable for digital output function)
DO Failsafe	DIO, DO (parameter only applicable for digital output function)
DO Restart Mode	DIO, DO (parameter only applicable for digital output function)
DI Filter	DIO, InDI (parameter only applicable for digital input function)put
DI Logic	DIO, DI (parameter only applicable for digital input function)
DI Extension	DIO, DI (parameter only applicable for digital input function)

The following chapters represent different setting groups with its configuration parameters. They are ingredients of the configuration assembly and can be set via *Explicit Messaging* by the specified CIP object classes. The **default values** are highlighted.

9.1 General settings

Configuration parameter	Byte offset config. assembly	Data type	Valid values	CIP object class 0xA0, Instance 1
Quick connect	0	SINT	0: Disable 1: Enable	Attribute 1
Force Mode Lock	1	SINT	0: Disable 1: Enable	Attribute 2
Web Interface Lock	2	SINT	0: Disable 1: Enable	Attribute 3
Reserved	3	SINT	–	Attribute 4
Report U_L/U_{Aux} Supply Voltage Fault	4	SINT	0: Disable 1: Enable 2: Auto	Attribute 5
Report DO Fault without U_L/U_{Aux}	5	SINT	0: Disable 1: Enable	Attribute 6
CIP object configuration lock	24	SINT	0: Disable 1: Enable	Attribute 25
External configuration lock	25	SINT	0: Disable 1: Enable	Attribute 26

9.1.1 QuickConnect

QuickConnect (QC) enables the module to perform the start-up process faster. With the activation of this parameter, a particularly quick start-up of EtherNet/IP communication is possible.

If you enable QuickConnect, the LioN-X module accepts a TCP connection within 350 ms after being switched on. Then the control system establishes a connection. The LioN-X Digital I/O module achieves a start-up time of 400 to 500 ms.

To use QuickConnect, the network must be set up in a star or line topology and the LioN-X Digital I/O module must have a static IP address. Ring topologies and DHCP/BOOTP are not supported. Please note that there is no automatic check performed for IP addresses that are assigned more than once inside the same network.

If QuickConnect is activated, the following fix parameters for the Ethernet interface of the LioN-X Digital I/O module are set:

- ▶ 100 Mbit/s transmission speed
- ▶ Full duplex connection
- ▶ Auto-negotiation and auto-MDIX deactivated



Attention: The prerequisite for the use of QuickConnect is the adherence to a strictly prescribed procedure. The LioN-X Digital I/O modules must be notified before switch-off (inhibit instruction) and switch-on (uninhibit instruction). A hard disconnect during operation is not permitted. Details of this procedure can be found in Rockwell Automation's document "ENET-AT001C-ENP".

9.1.2 Force mode lock

The input and output process data can be forced via different interfaces (e.g. Web interface, REST, OPC UA, MQTT). The support of interfaces depends on the available software features. If the *Force mode lock* is enabled, it is no longer possible to force input and output process data through these interfaces.



Danger: Risk of physical injury or death! Unattended forcing can lead to unexpected signals and uncontrolled machine movements.

9.1.3 Web interface lock

The Web interface access can be configured. If *Web interface lock* is enabled, the Web pages are no longer reachable.

9.1.4 Report U_L/U_{AUX} supply voltage fault

During commissioning, it is possible that no power supply is connected to the U_L/U_{AUX} pins. Therefore it can be helpful to suppress and disable the *U_L/U_{AUX} supply voltage fault* diagnosis.

- ▶ Disable: Suppress the *U_L/U_{AUX} supply voltage fault* diagnosis.
- ▶ Enable: Report the *U_L/U_{AUX} supply voltage fault* diagnosis if no power supply is connected.
- ▶ Auto: *U_L/U_{AUX} supply voltage fault* diagnosis mechanism is activated with the first rising slope detection after power-up. If the power supply is then disconnected, the diagnosis is reported.

9.1.5 Report DO Fault without U_L/U_{Aux}

With this parameter you suppress the actuator diagnosis message that is sent if no U_L/U_{Aux} supply is connected while the output data of a digital channel is controlled.

9.1.6 CIP object configuration lock

When there is no *Exclusive Owner* connection established, all configuration parameters can be set by vendor specific CIP object classes. To exclude parameter changes the setting function of these objects can be blocked.

When the *CIP object* configuration lock is enabled, the vendor specific configuration parameters cannot be set via the CIP services. This relates also to the *CIP object* configuration lock itself. A reset of this parameter can be done by a configuration assembly when an *Exclusive Owner* connection is established.

9.1.7 External configuration lock

Configuration parameters can be set via different alternative interfaces (e.g. Web interface, REST, OPC UA, MQTT). An external configuration can only

be done, if no cyclic PLC connection is active. Every new PLC configuration overwrites the external configuration settings.

9.2 Channel settings

Configuration parameter	Byte offset config. assembly	Data type	Valid values	CIP object class 0xA1, Instance 1 .. 16
IO Mapping (Ch1 ..1 16)	32	SINT[16]	01 ..1 15 : Bit number of 16 channel process data 16: Inactive	Attribute 1
DO Surveillance Timeout (Ch11 ..1 16)	48	INT[16]	01 ..1 255 (80)	Attribute 2
DO Failsafe (Ch11 ..1 16)	80	SINT[16]	0: Set Low 1: Set High 2: Hold Last	Attribute 3
DO Restart Mode (Ch1 .. 16)	96	SINT[16]	0: Disable 1: Enable	Attribute 4
DI Logic (Ch1 .. 16)	128	SINT[16]	0: Normally Open 1: Normally Close	Attribute 6
DI Filter (Ch1 .. 16)	144	SINT[16]	0: Disable 1: 1 ms 2: 2 ms 3: 3 ms 4: 6 ms 5: 10 ms 6: 15 ms	Attribute 7
DI Extension (Ch1 .. 16)	176	SINT[16]	0: Disable 1: 8 ms 2: 16 ms 3: 64 ms	Attribute 9

Configuration parameter	Byte offset config. assembly	Data type	Valid values	CIP object class 0xA1, Instance 1 .. 16
Channel Mode (Ch1 .. 16)	192	SINT[16]	0: Digital Input/Digital Output 1: Digital Output 2: Digital Input 3: Inactive The supported Channel Mode and the default value depend on the device variant.	Attribute 10

Assignment of channels:

Channel 1	Port X1.ChA	CIP object instance 1
Channel 2	Port X1.ChB	CIP object instance 2
[...]	[...]	[...]
Channel 15	Port X8.ChA	CIP object instance 15
Channel 16	Port X8.ChB	CIP object instance 16

9.2.1 IO Mapping (Ch1 .. 16)

These configuration parameters can be used to set a user defined IO mapping. It is valid for the input and output data direction. Double assignments are not allowed.

In case of an inconsistent mapping, the complete assembly configuration is rejected with an error code.

9.2.2 DO Surveillance Timeout (Ch1 .. 16)

The digital output channels are monitored during runtime. The error states are detected and reported as a diagnosis. To avoid error states during the switching of output channels, the surveillance timeout can be configured as a delay with deactivated monitoring.

The delay time begins with a rising edge of the output control bit. After delay time has elapsed, the output is monitored and error states are reported by diagnosis. When the channel is permanently switched on or off, the typical filter value (not changeable) is 5 ms.

9.2.3 DO Failsafe (Ch1 .. 16)

The LioN-X devices support a failsafe function for the channels used as digital outputs. In case of an internal device error, the PLC is in STOP state and cannot provide valid process data. The connection is interrupted or the communication is lost. The outputs are controlled according to the configured failsafe values.

Set Low:

If failsafe is active, the physical output pin of the channel is set to low ("0").

Set High:

If failsafe is active, the physical output pin of the channel is set to high ("1").

Hold Last:

If failsafe is active, the physical output pin of the channel holds the last valid process data state ("0" or "1").

9.2.4 DO Restart Mode (Ch1 .. 16)

In case of a short circuit or overload at an output channel, a diagnosis is reported and the output is switched to "off".

If the *DO Restart Mode* for this channel is enabled, the output will automatically be turned on again after a fix time delay for checking if the overload or short circuit condition is still active. When it is active, the channel is switched off again.

If the *DO Restart Mode* is disabled, the output channel is not automatically turned on again. It can be turned on after a logical reset of the process output data of the channel.

9.2.5 DI Logic (Ch1 .. 16)

The logical state of an input channel can be configured via these parameters. If a channel is set to "Normally Open", a low signal ("0") is transferred to the process input data (e.g. if a non-damped sensor has an open switching output).

If a channel is set to "Normally Close", a high signal ("0") is transferred to the process input data (e.g. if a non-damped sensor has a closed switching output).

The channel LED shows, independent of these settings, the physical input state of the port pin.

9.2.6 DI Filter (Ch1 .. 16)

A filter time for every digital input channel can be configured by these parameters. When there is no need for a filter it can be disabled.

9.2.7 DI Extension

This parameter is used to configure the DI Extension for all 16 Channels with a single parameter.

It is a 32bit signed integer used as a bit-field, with each channel occupying 2 bits. Starting with Port 1 Channel A at bit 0 (LSB), Port 1 Channel B at bit 2, Port 2 Channel A at bit 4, ..., Port 8 Channel B at bit 30 (MSB).

For each channel, the DI Extension is encoded as follows:

- ▶ (00) 0: Disable

- ▶ (01) 1: 8 ms
- ▶ (10) 2: 16 ms
- ▶ (11) 3: 64 ms

For example, to configure the DI Extension for Port 1 Channel B to '8 ms' and for Port 6 Channel A to '64 ms' while keeping it disabled for all other channels, the corresponding bit-field would be '00000000011000000000000000100', so the parameter would have to be configured to '3145732'.



Note: Only applicable for firmware version 11.2 or higher in combination with the latest [device description file](#).

This parameter extends the duration of the digital input status after a state change at the physical input, when the input state change is faster than the extension time set.

The extension time will be applied on 'high' to 'low' and 'low' to 'high' input transitions. This setting only works for channels that have been set to 'digital input'.

Example:

The DI extension parameter is set to 16 ms, the physical input signal has low status => a high signal is detected for 8 ms.

In this case, the DI channel reports a high-status signal for 16 ms, regardless of other physical input signal transitions during this time.

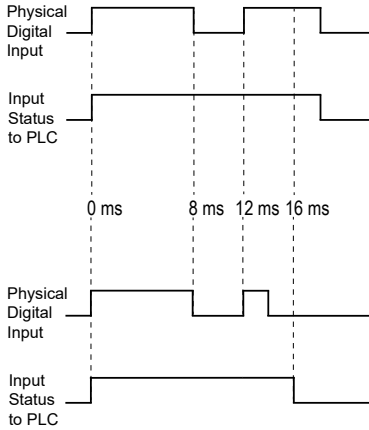

Figure 9: DI Extension

Default: Off (0)

9.2.8 Channel Mode (Ch1 .. 16)

The operation mode of every channel can be configured by these parameters. The usability of this setting depends on the hardware variant and can be figured out in the description (e.g. for a 16DIO, 16DI or 8DI/8DO).

Digital Input/Digital Output:

In this mode, the channel operates as digital input/output. The channel can be controlled by the *Digital Output Channel Control* (first two bytes of the output data) and the channel state can be seen in the *Digital Input Channel Status* of the cyclic process data.

Digital Output:

In this mode, the channel operates as digital output. The channel can be controlled by the *Digital Output Channel Control* (first two bytes of the output data)

Digital Input:

In this mode, the channel operates as digital input. The channel state can be seen in the *Digital Input Channel Status* of the cyclic process data.

Inactive:

This mode should be selected when the channel is not in use.

10 Process data assignment

The LioN-X devices in general support process data communication in both directions. The consuming data in this context is defined as the process output data which controls physical outputs. The producing data in this context is defined as the process input data which contains the physical inputs, standard diagnostics and optional extended diagnostics.

The following sections describe the data images for the consuming and producing data direction which are assigned to the output and input assemblies.



Attention: Depending on the engineering tool used, the numbering of the registers is displayed as octal, decimal or hexadecimal.

10.1 Consuming data image (output)

Output data frame	Digital output channel control	Reserved (e.g. feature control)
Consuming data size	2 Byte, INT	2 Byte, INT

The complete *Output data frame* has a fix size of 4 Bytes. In general, a 4 Byte Run/Idle Header precedes, resulting in up to 8 Bytes in total.

The following chapters describe the bit assignment.

10.1.1 Digital output channel control

Digital output channel control	Bit	7	6	5	4	3	2	1	0
Channel number (default mapping)	Byte 0	8	7	6	5	4	3	2	1
	Byte 1	16	15	14	13	12	11	10	9

The control values are effective if the respective channels are configured as outputs.

10.2 Producing data image (input)

Input data frame	Digital input channel status	General diagnostics	Sensor diagnostics	Actuator/U _L diagnostics
Producing data size	2 Byte, INT	2 Byte, INT	2 Byte, INT	2 Byte, INT

The complete *Input data frame* has a fixed size of 8 Bytes (6 Bytes for the 16DI variant).

The following chapters describe the bit assignment.

10.2.1 Digital input channel status

Digital input channel status	Bit	7	6	5	4	3	2	1	0
Channel number (default mapping)	Byte 0	8	7	6	5	4	3	2	1
	Byte 1	16	15	14	13	12	11	10	9

Each status value is effective if the channel is configured as Input.

10.2.2 General diagnostics

General diagnostics	Bit	7	6	5	4	3	2	1	0
General Bit	Byte 0	IME	FME	0	0	SCA	SCS	LVA	LVS
	Byte 1	0	0	0	0	0	0	0	0

LVS

Low Voltage System/Sensor Supply

LVA

Low Voltage Actuator Supply

SCS

Short Circuit Sensor

SCA

Short Circuit Actuator/U_L/U_{Aux}

FME	Force Mode Enabled
IME	Internal Module Error
0	Reserved

10.2.3 Sensor diagnostics

Sensor diagnostics	Bit	7	6	5	4	3	2	1	0
Port number	Byte 0	X8	X7	X6	X5	X4	X3	X2	X1
	Byte 1	0	0	0	0	0	0	0	0

X1 .. 8	Sensor Short Circuit on Port X1 .. X8
0	Reserved

10.2.4 Actuator/U_L diagnostics

Actuator/U _L diagnostics	Bit	7	6	5	4	3	2	1	0
Channel number (fix)	Byte 0	8	7	6	5	4	3	2	1
	Byte 1	16	15	14	13	12	11	10	9

1 .. 16	Actuator/U _L channel error on channel 1 .. 16
----------------	--

10.3 Producing data image (Extended diagnoses)

Input data frame	U _S voltage	U _L voltage
Producing data size	2 Byte, INT	2 Byte, INT

The complete *Input data frame* has a fixed size of 4 Bytes for 16DIO and 8DI/8DO variants and 2 Bytes for 16DI variants.

The following chapters describe the bit assignment.

Byte offset	Input data
0	U _S voltage (2 Bytes)
2	U _L voltage (2 Bytes)

10.4 Sample applications

The following application samples describe the process data assignments for the input and output data including the byte offsets. When there is no need to configure the data sizes, use the first sample to get the default byte offsets for your application.

10.4.1 Process data images – default configuration

The default configuration of the digital input and output data sizes are fixed in the EDS files. This means the user gets all data of each digital channel. The following tables provide you an overview of the data structures and the byte offsets for input and output data:

Connection parameters

Output data size	4
Input data size	8

Byte offset	Output data
0	Digital output channel control (2 bytes)
2	Reserved (2 bytes)

Table 13: Default output process data

Byte offset	Input data
0	Digital input channel status (2 bytes)
2	General diagnostics (2 bytes)
4	Sensor diagnostics (2 bytes)
6	Actuator diagnostics (2 bytes)

Table 14: Default input process data

11 Configuration and operation with Rockwell Automation Studio 5000®

The configuration and start-up of the LioN-X devices described on the following pages refers to Rockwell Automation Studio 5000®, V30. If you are using an engineering tool from another provider, please consider the related documentation.

11.1 Basic commissioning

Perform the following working steps:

1. Create a new project in Studio 5000®.
2. Select the correct controller.
3. When no integrated EtherNet/IP interface is available, add the proper communication interface to your backplane under **Controller Organizer > I/O-Configuration**.
4. Set a communication path to enable the project download.
5. Install the EDS files of the LioN-X devices in Studio 5000® with the EDS hardware installation tool.
6. Go to **Controller Organizer > I/O-Configuration** and right-click the Ethernet interface.

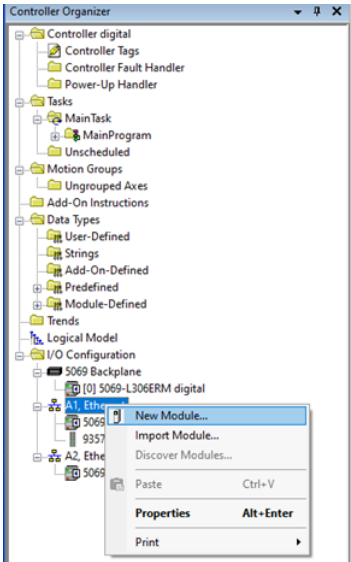

7. Select **New Module** in the menu. The following selection window opens:

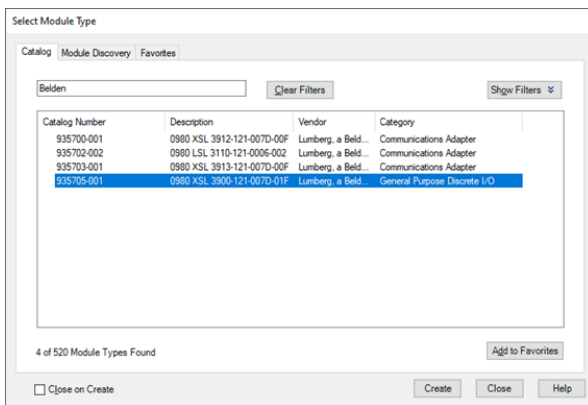

8. Use the **Module Type Vendor Filter** on the right side to display all installed devices of Belden Deutschland GmbH.

9. Select the device you wish to add and click on **Create**.

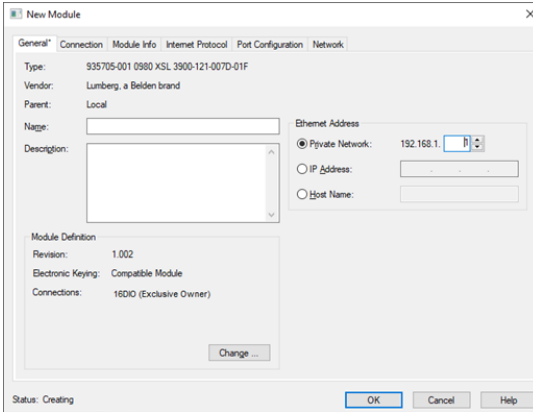

10. Enter a name for the device and set the chosen IP address. In this example, the name is **MOD01_DIGITAL** and the IP address is **192.168.1.1**.

11. Click on **Change** in order to change the settings for the device revision, electronic keying and connection type.

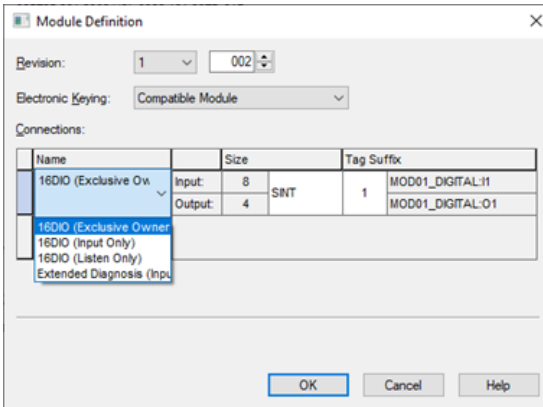

12. Select the connection type and configure the total sizes of the input and output process data. The sizes depend on the number of connected devices and their data lengths of both directions. Each device input and output data size must also be set later in the port configuration. The selection of the data type refers to the type in which Studio 5000® maps the input and output data. The default data type is SINT. The INT type is selectable when each size is

a multiple of 2. The DINT type is selectable when each size is a multiple of 4. Click on **OK**.

13. In the **Connection** folder of the **Module Properties**, you see the selected connection. This folder also lets you define the **Requested Packet Interval (RPI)** and the EtherNet/IP connection type. A value of 1 ms is the minimum for parameter RPI and the connection types *Unicast* or *Multicast* can be chosen. Apply the settings.

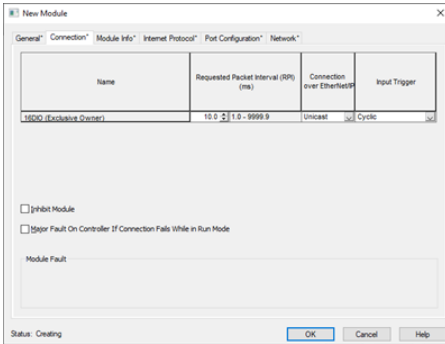

14. Move to **Controller-Tags** in **Controller Organizer**. The controller tags for the configuration parameters contain the name of the device, followed by a **":C"**. The configuration parameters can be set under **Value** and are described in chapter [Configuration parameters](#) on page 50.

Name	Value	Force Mask	Style	Data Type	Description
MOD01_DIGITALC	[...]	[...]		_0015:935705_001_78B4	
MOD01_DIGITALC Quick_Connect	0		Decimal	BOOL	
MOD01_DIGITALC Force_Mode_Lock	0		Decimal	BOOL	
MOD01_DIGITALC Web_Interface_Lock	0		Decimal	BOOL	
MOD01_DIGITALC Report_UL_Supply_Voltage_Fault	1		Decimal	BOOL	
MOD01_DIGITALC Report_DO_Fault_without_UL	1		Decimal	BOOL	
MOD01_DIGITALC CIP_object_configuration_lock	0		Decimal	BOOL	
MOD01_DIGITALC External_configuration_lock	0		Decimal	BOOL	
+ MOD01_DIGITALC IO_Mapping_Port1_Ch_A	0		Decimal	SINT	
+ MOD01_DIGITALC IO_Mapping_Port1_Ch_B	1		Decimal	SINT	
+ MOD01_DIGITALC IO_Mapping_Port2_Ch_A	2		Decimal	SINT	
+ MOD01_DIGITALC IO_Mapping_Port2_Ch_B	3		Decimal	SINT	
+ MOD01_DIGITALC IO_Mapping_Port3_Ch_A	4		Decimal	SINT	
+ MOD01_DIGITALC IO_Mapping_Port3_Ch_B	5		Decimal	SINT	
+ MOD01_DIGITALC IO_Mapping_Port4_Ch_A	6		Decimal	SINT	
+ MOD01_DIGITALC IO_Mapping_Port4_Ch_B	7		Decimal	SINT	
+ MOD01_DIGITALC IO_Mapping_Port5_Ch_A	8		Decimal	SINT	
+ MOD01_DIGITALC IO_Mapping_Port5_Ch_B	9		Decimal	SINT	
+ MOD01_DIGITALC IO_Mapping_Port6_Ch_A	10		Decimal	SINT	
+ MOD01_DIGITALC IO_Mapping_Port6_Ch_B	11		Decimal	SINT	
+ MOD01_DIGITALC IO_Mapping_Port7_Ch_A	12		Decimal	SINT	
+ MOD01_DIGITALC IO_Mapping_Port7_Ch_B	13		Decimal	SINT	
+ MOD01_DIGITALC IO_Mapping_Port8_Ch_A	14		Decimal	SINT	
+ MOD01_DIGITALC IO_Mapping_Port8_Ch_B	15		Decimal	SINT	
+ MOD01_DIGITALC DO_Surveillance_Timeout_Port1_Ch_A	80		Decimal	INT	
+ MOD01_DIGITALC DO_Surveillance_Timeout_Port1_Ch_B	80		Decimal	INT	
+ MOD01_DIGITALC DO_Surveillance_Timeout_Port2_Ch_A	80		Decimal	INT	
+ MOD01_DIGITALC DO_Surveillance_Timeout_Port2_Ch_B	80		Decimal	INT	
+ MOD01_DIGITALC DO_Surveillance_Timeout_Port3_Ch_A	80		Decimal	INT	
+ MOD01_DIGITALC DO_Surveillance_Timeout_Port3_Ch_B	80		Decimal	INT	
+ MOD01_DIGITALC DO_Surveillance_Timeout_Port4_Ch_A	80		Decimal	INT	
+ MOD01_DIGITALC DO_Surveillance_Timeout_Port4_Ch_B	80		Decimal	INT	
+ MOD01_DIGITALC DO_Surveillance_Timeout_Port5_Ch_A	80		Decimal	INT	
+ MOD01_DIGITALC DO_Surveillance_Timeout_Port5_Ch_B	80		Decimal	INT	
+ MOD01_DIGITALC DO_Surveillance_Timeout_Port6_Ch_A	80		Decimal	INT	
+ MOD01_DIGITALC DO_Surveillance_Timeout_Port6_Ch_B	80		Decimal	INT	
+ MOD01_DIGITALC DO_Surveillance_Timeout_Port7_Ch_A	80		Decimal	INT	
+ MOD01_DIGITALC DO_Surveillance_Timeout_Port7_Ch_B	80		Decimal	INT	
+ MOD01_DIGITALC DO_Surveillance_Timeout_Port8_Ch_A	80		Decimal	INT	
+ MOD01_DIGITALC DO_Surveillance_Timeout_Port8_Ch_B	80		Decimal	INT	

15. The tag of the input process data contain the name of the device, followed by a ":I.Data". The output process data has the same name followed by a ":O.Data". Both arrays show its configured data sizes. The content of them is described in chapter [Process data assignment](#) on page 62.

Name	Value	Force Mask	Style	Data Type
+ MOD01_DIGITALC	[...]	[...]		_0015:935705_001_78B4
- MOD01_DIGITALI1	[...]	[...]		_0015:935705_001_F211...
MOD01_DIGITALI1.ConnectionFaulted	0		Decimal	BOOL
+ MOD01_DIGITALI1.Data	[...]	[...]	Decimal	SINT[8]
- MOD01_DIGITALO1	[...]	[...]		_0015:935705_001_AAB...
- MOD01_DIGITALO1.Data	[...]	[...]	Decimal	SINT[4]
+ MOD01_DIGITALO1.Data[0]	0		Decimal	SINT
+ MOD01_DIGITALO1.Data[1]	0		Decimal	SINT
+ MOD01_DIGITALO1.Data[2]	0		Decimal	SINT
+ MOD01_DIGITALO1.Data[3]	0		Decimal	SINT

16. When the configuration is completed, the parameters can be downloaded to the EtherNet/IP controller.

12 CIP object classes

12.1 EtherNet/IP object classes

According to the CIP specification, the LioN-X variants support the following standard EtherNet/IP object classes:

Object Class	Object ID	Instances
Identity Object	0x01	0, 1
Message Router Object	0x02	0 (only on class level)
Assembly Object	0x04	0, 130, 131, 145
Connection Manager Object	0x06	0 (only on class level)
Discrete Input Point Object	0x08	0, 1 .. 16
DLR Object	0x47	0, 1
QoS Object	0x48	0, 1
TCP/IP Interface Object	0xF5	0, 1
Ethernet Link Object	0xF6	0, 1 .. 2
LLDP Management Object	0x109	0, 1

All objects with instance attributes are described in the following chapters.

12.1.1 Identity Object (0x01)

Supported services:

Get Attributes All (0x01)

Reset (0x05): 0 = Reset Module (Warmstart), 1 = Reset to Factory Default

Get Attribute Single (0x0E)

Class attribute (Instance 0)

Attribute	Name	Access	Data type	Description
1	Revision	Get	UINT	Revision of this object
2	Max. Instance	Get	UINT	Maximum instance number of an object currently created in this class level of the device
6	Maximum ID Number Class Attributes	Get	UINT	The attribute ID number of the last class attribute of the class definition implemented in the device
7	Maximum ID Number Instance Attributes	Get	UINT	The attribute ID number of the last instance attribute of the class definition implemented in the device.

Instance attribute (Instance 1)

Attribute	Name	Access	Data Type	Description
1	Vendor ID	Get	UINT	Vendor Identification
2	Device Type	Get	UINT	Indication of general type of product
3	Product Code	Get	UINT	Identification of a particular product of an individual vendor
4	Revision	Get	USINT, USINT	Structure with major and minor revision
5	Status	Get	WORD	<p>Summary status of device:</p> <p>b0: Owned</p> <p>b1: Reserved ("0")</p> <p>b2: Configured</p> <p>b3: Reserved ("0")</p> <p>b4 .. 7: Extended Device Status</p> <p>0 = Self-Testing or Unknown</p> <p>1 = Firmware Update in Progress</p> <p>2 = At least one faulted I/O connection</p> <p>3 = No I/O connections established</p> <p>4 = Non-Volatile Configuration bad</p> <p>5 = Major Fault</p> <p>6 = At least one I/O connection in RUN mode</p> <p>7 = At least one I/O connection established, all in IDLE mode</p> <p>8 = Unused (valid only for instances greater than "1")</p> <p>9 = Reserved</p> <p>10 .. 15 = Vendor specific</p> <p>b8: Minor Recoverable Fault</p> <p>b9: Minor Unrecoverable Fault</p> <p>b10: Major Recoverable Fault</p> <p>b11: Major Unrecoverable Fault</p> <p>b12 .. 15: Reserved ("0")</p>
6	Serial Number	Get	UDINT	Serial number of device
7	Product Name	Get	STRING	Human readable identification

Attribute	Name	Access	Data Type	Description
8	State	Get	USINT	Present state of the device: 0 = Nonexistent 1 = Device Self Testing 2 = Standby 3 = Operational 4 = Major Recoverable Fault 5 = Major Unrecoverable Fault 6 .. 254 = Reserved 255 = Default Value
9	Configuration Consistency Value	Get	UINT	Can be a CRC, incrementing count or any other mechanism (vendor specific behavior) to reflect a non-volatile configuration change
19	Protection Mode	Get	WORD	Current protection mode of the device: b0: Implicit Protection enabled b1 .. 2: Reserved b3: Explicit Protection enabled b4 .. 15: Reserved

12.1.2 Assembly Object (0x04)

Supported services:

Get Attribute Single (0x0E)

Set Attribute Single (0x10)

Class attribute (Instance 0)

Attribute	Name	Access	Data type	Description
1	Revision	Get	UINT	Revision of this object
2	Max. Instance	Get	UINT	Maximum instance number of an object currently created in this class level of the device
3	Number of Instances	Get	UINT	Number of Instances currently created in this class level of the device
6	Maximum ID Number Class Attributes	Get	UINT	The attribute ID number of the last class attribute of the class definition implemented in the device
7	Maximum ID Number Instance Attributes	Get	UINT	The attribute ID number of the last instance attribute of the class definition implemented in the device.

Instance attribute (Instance <AssemblyID>)

Attribute	Name	Access	Data Type	Description
3	Data	Get, Set	ARRAY	Assembly Data (Set service only available for consuming assemblies that are not part of an active implicit connection)
4	Size	Get	UINT	Number of bytes in Attribute 3

12.1.3 Discrete Input Point Object (0x08)

Supported services:

Get Attribute Single (0x0E)

Class attribute (Instance 0)

Attribute	Name	Access	Data type	Description
1	Revision	Get	UINT	Revision of this object

Instance attribute (Instance 1 .. 16)

Attribute	Name	Access	Data type	Description
3	Value	Get	BOOL	Input Point Value (0 = OFF, 1 = ON)
4	Status	Get	BOOL	Input Point Status (0 = OK, 1 = Alarm)

12.1.4 DLR Object (0x47)

Supported services:

Get Attributes All (0x01)

Get Attribute Single (0x0E)

Class attribute (Instance 0)

Attribute	Name	Access	Data type	Description
1	Revision	Get	UINT	Revision of this object
2	Max. Instance	Get	UINT	Maximum instance number of an object currently created in this class level of the device
6	Maximum ID Number Class Attributes	Get	UINT	The attribute ID number of the last class attribute of the class definition implemented in the device
7	Maximum ID Number Instance Attributes	Get	UINT	The attribute ID number of the last instance attribute of the class definition implemented in the device.

Instance attribute (Instance 1)

Attribute	Name	Access	Data type	Description
1	Network Topology	Get	BOOL	0 = Linear 1 = Ring
2	Network Status	Get	USINT	0 = Normal operation 1 = Ring Fault 2 = Unexpected Loop Detected 3 = Partial Network Fault 4 = Rapid Fault/Restore Cycle
10	Active Supervisor Address	Get	ARRAY	Supervisor IP Address, Supervisor MAC Address (0 = not configured)
12	Capability Flags	Get	DWORD	Flag description: b0: Announce-based Ring Node ("0") b1: Beacon-based Ring Node ("1") b2 .. 4: Reserved ("0") b5: Supervisor Capable ("0") b6: Redundant Gateway Capable ("0") b7: Flush_Table frame Capable ("1") b8 .. 15: Reserved ("0")

12.1.5 QoS Object (0x48)

Supported services:

Get Attribute Single (0x0E)

Set Attribute Single (0x10)

Class attribute (Instance 0)

Attribute	Name	Access	Data type	Description
1	Revision	Get	UINT	Revision of this object
2	Max. Instance	Get	UINT	Maximum instance number of an object currently created in this class level of the device
6	Maximum ID Number Class Attributes	Get	UINT	The attribute ID number of the last class attribute of the class definition implemented in the device
7	Maximum ID Number Instance Attributes	Get	UINT	The attribute ID number of the last instance attribute of the class definition implemented in the device.

Instance attribute (Instance 1)

Attribute	Name	Access	Data type	Description
2	DSCP PTP Event	Get, Set	USINT	DSCP value for PTP Event frames (default value "59")
3	DSCP PTP General	Get, Set	USINT	DSCP value for PTP General frames (default value "47")
4	DSCP Urgent	Get, Set	USINT	CIP transport class 0/1 messages with Urgent priority (default value "55")
5	DSCP Scheduled	Get, Set	USINT	CIP transport class 0/1 messages with Scheduled priority (default value "47")
6	DSCP High	Get, Set	USINT	CIP transport class 0/1 messages with High priority (default value "43")
7	DSCP Low	Get, Set	USINT	CIP transport class 0/1 messages with Low priority (default value "31")
8	DSCP Explicit	Get, Set	USINT	CIP UCMM, CIP transport class 2/3, All other EtherNet/IP encapsulation messages (default value "27")

12.1.6 TCP/IP Object (0xF5)

Supported services:

Get Attributes All (0x01)

Get Attribute Single (0x0E)

Set Attribute Single (0x10)

Class attribute (Instance 0)

Attribute	Name	Access	Data type	Description
1	Revision	Get	UINT	Revision of this object
2	Max. Instance	Get	UINT	Maximum instance number of an object currently created in this class level of the device.

Instance attribute (Instance 1)

Attribute	Name	Access	Data type	Description
1	Status	Get	DWORD	Interface Status description: b0 .. 3: Interface Configuration Status 0 = Not configured 1 = Configuration obtained by BOOTP, DHCP or stored value 2 = Configuration obtained by hardware settings (e.g. rotary switches) 3 .. 15 = Reserved b4: Mcast Pending b5: Interface Configuration Pending b6: Acd Status b7: Acd Fault b8 .. 31: Reserved ("0")

Attribute	Name	Access	Data type	Description
2	Configuration Capability	Get	DWORD	Interface Capability Flags: b0: BOOTP Client ("1") b1: DNS Client ("0") b2: DHCP Client ("1") b3: DHCP-DNS Update ("0") b4: Configuration Settable ("1") b5: Hardware Configurable (0 = no rotary switches; 1 = rotary switches available) b6: Interface Configuration Change Requires Reset ("0") b7: Acd Capable ("1") b8 .. 31: Reserved ("0")
3	Configuration Control	Get, Set	DWORD	Interface Control Flags: b0 .. 3: Configuration Method: 0 = Stored Value 1 = BOOTP 2 = DHCP 3 .. 15 = Reserved b4: DNS Enable ("0") b5 .. 31: Reserved ("0")
4	Physical Link Object	Get	STRUCT	Path to physical link object
5	Interface Configuration	Get, Set	STRUCT	TCP/IP network interface configuration
6	Host Name	Get, Set	STRING	Host name of the device (length of 0 = not configured)
10	Select Acd	Get, Set	BOOL	Enables ("1") or disables ("0") the use of ACD (default value "1")
11	Last Conflict Detected	Get, Set	STRUCT	Structure containing information related to the last conflict detected
13	Encapsulation Inactivity Timeout	Get, Set	UINT	Number of seconds of inactivity before TCP connection is closed: 0 = disable 1 .. 3600 = timeout in seconds 120 = default value

12.1.7 Ethernet Link Object (0xF6)

Supported services:

Get Attribute Single (0x0E)

Set Attribute Single (0x10)

Get and Clear (0x4C)

Class attribute (Instance 0)

Attribute	Name	Access	Data type	Description
1	Revision	Get	UINT	Revision of this object
2	Max. Instance	Get	UINT	Maximum instance number of an object currently created in this class level of the device.
3	Number of Instances	Get	UINT	Number of object instances currently created at this class level of the device (in this case number of ethernet ports)

Instance attribute (Instance 1 .. 2)

Attribute	Name	Access	Data type	Description
1	Interface Speed	Get	UDINT	Current Interface speed in Mbps
2	Interface Flags	Get	DWORD	Interface Flags: b0: Link Status b1: Half ("0") or Full ("1") Duplex b2 .. 4: Negotiation Status: 0 = Auto-negotiation in progress 1 = Auto-negotiation and speed detection failed (using default 10Mbps and half duplex) 2 = Auto negotiation failed but detected speed (using default half duplex) 3 = Successfully negotiated speed and duplex 4 = Auto-negotiation not attempted (forced speed and duplex) b5: Manual Setting Requires Reset b6: Local Hardware Fault b7 .. 31: Reserved ("0")
3	Physical Address	Get	ARRAY	MAC address
4	Interface Counters	Get	STRUCT	Interface Counters
5	Media Counters	Get	STRUCT	Media-specific counters
6	Interface Control	Get, Set	STRUCT	Configuration for physical interface Control Bits (WORD): b0: Auto-negotiate b1: Forced Duplex Mode (0 = Half Duplex; 1 = Full Duplex, only valid when Auto-negotiate = 0) b2 .. 15: Reserved ("0") <i>Forced Interface Speed in Mbps (UINT)</i>

Attribute	Name	Access	Data type	Description
7	Interface Type	Get	USINT	Type of interface: 0 = Unknown interface type 1 = Internal interface 2 = Twisted-pair 3 = Optical fiber 4 .. 255 = Reserved
8	Interface State	Get	USINT	State of interface: 0 = Unknown 1 = Enabled and ready to send and receive data 2 = Disabled 3 = Testing 4 .. 255 = Reserved
9	Admin State	Get, Set	USINT	Administrative state: 0 = Reserved 1 = Enable interface 2 = Disable interface 3 .. 255 = Reserved
10	Interface Label	Get	STRING	Human readable identification (size max. 64)
11	Interface Capability	Get	STRUCT	Interface Capability Flags (DWORD): b0: Manual Setting Requires Reset ("0") b1: Auto-negotiate ("1") b2: Auto-MDIX ("1") b3: Manual Speed/Duplex ("1") b4 .. 31: Reserved ("0") Speed/Duplex Array Count of following struct (USINT, 4) Interface Speed in Mbps (UINT, 10/100) Interface Duplex Mode (USINT, 0/1): 0 = Half Duplex 1 = Full Duplex 2 .. 255 = Reserved

12.1.8 LLDP Management Object (0x109)

Supported services:

Get Attributes All (0x01)

Get Attribute Single (0x0E)

Set Attribute Single (0x10)

Class attribute (Instance 0)

Attribute	Name	Access	Data type	Description
1	Revision	Get	UINT	Revision of this object
2	Max. Instance	Get	UINT	Maximum instance number of an object currently created in this class level of the device.
3	Number of Instances	Get	UINT	Number of object instances currently created at this class level of the device (in this case number of ethernet ports)
6	Maximum ID Number Class Attributes	Get	UINT	Attribute ID number of the last class attribute
7	Maximum ID Number Instance Attributes	Get	UINT	Attribute ID number of the last instance attribute

Instance attribute (Instance 1)

Attribute	Name	Access	Data type	Description
1	LLDP Enable	Get/Set	STRUCT	<p>LLDP Enable Array Length (UINT): 1 + Class attribute 2 from the Ethernet Link Object (0xF6) = 3</p> <p>LLDP Enable Array (BYTE):</p> <p>b0: Global Enable, LLDP Tx & Rx Enabled (1)</p> <p>b1: LLDP Tx Enabled (Instance 1 of Ethernet Link Object) (1)</p> <p>b2: LLDP Tx Enabled (Instance 2 of Ethernet Link Object) (1)</p>
2	msgTxInterval	Get/Set	UINT	<p>From 802.1AB-2016: Interval in seconds for transmitting LLDP frames from this device</p> <p>0 .. 4 = Reserved</p> <p>5 .. 32768 = Message Transmission Interval for LLDP frames (30)</p> <p>32769 .. 65535 = Reserved</p>
3	msgTxHold	Get/Set	USINT	<p>From 802.1AB-2016: Multiplier of msgTxInterval to determine the value of the TTL TLV sent to neighboring devices</p> <p>0 = Reserved</p> <p>1 .. 100 = Message Transmission Multiplier for LLDP Frames (4)</p> <p>101 .. 255 = Reserved</p>
4	LLDP Datastore	Get	WORD	<p>Indication of the retrieval methods for the LLDP database:</p> <p>b0: LLDP Data Table Object (0)</p> <p>b1: SNMP (1)</p> <p>b2: NETCONF YANG (0)</p> <p>b3: RESTCONF YANG (0)</p> <p>b4 .. b15: Reserved (0)</p>
5	Last Change	Get	UDINT	Counter in seconds from the last time any entry in the local LLDP database changed or power up

12.1.9 LLDP Data Table Object (0x10A)

Supported services:

Get Attribute Single (0x0E)

Find Next Object Instance (0x11), only available for Instance 0

Class attribute (Instance 0)

Attribute	Name	Access	Data type	Description
1	Revision	Get	UINT	Revision of this object
2	Max. Instance	Get	UINT	Maximum instance number of an object currently created in this class level of the device.
3	Number of Instances	Get	UINT	Number of object instances currently created at this class level of the device (in this case number of ethernet ports)
6	Maximum ID Number Class Attributes	Get	UINT	Attribute ID number of the last class attribute
7	Maximum ID Number Instance Attributes	Get	UINT	Attribute ID number of the last instance attribute

Instance attribute (Instance 1..8)

Attribute	Name	Access	Data type	Description
1	Ethernet Link Instance Number	Get	UINT	The Ethernet Link Object instance number relating to the physical Ethernet port where this LLDP frame was received: 0 = Unknown 1..65535 = Ethernet Link Object (0xF6) Instance Number
2	MAC Address	Get	ARRAY	Neighboring MAC address
3	Interface Label	Get/Set	SHORT_STRING	Neighboring interface label
4	Time To Live	Get	UINT	Time the neighboring information is valid in seconds: 0 = Reserved (table entry should be removed) 1..65535 = Time to live (in seconds)
5	System Capabilities TLV	Get	STRUCT	System capabilities of the neighboring system: System capabilities (WORD) Enabled capabilities (WORD) Bitmap of supported and enabled capabilities: b0: Other b1: Repeater b2: Bridge b3: Access Point b4: Router b5: Telephone b6: DOCSIS Cable Device b7: End Station b8: C-VLAN component b9: S-VLAN component b10: Two-port MAC Relay Component b1..15: Reserved by IEEE
6	IPv4 Management Addresses	Get	STRUCT	Neighboring IPv4 management addresses: Management Address Count (USINT) Management Address (ARRAY of UDINT)

Attribute	Name	Access	Data type	Description
7	CIP Identification	Get	STRUCT	CIP Identification of the neighboring device: Vendor ID (UINT) Device Type (UINT) Product Code (UINT) Major Revision (BYTE) Minor Revision (USINT) CIP Serial Number (UDINT)
8	Additional Ethernet Capabilities	Get	STRUCT	TLV for Ethernet Preemption Support from the neighboring device: Preemption Support (BOOL): 0 = Not supported 1 = Supported Preemption Status (BOOL): 0 = Not enabled 1 = Enabled Preemption Active (BOOL): 0 = Not active 1 = Active Additional Fragment Size (USINT): 0 = 64 octets 1 = 128 octets 2 = 192 octets 3 = 256 octets 4..255 = Reserved
9	Last Change	Get	UDINT	sysUpTime from the last time any attribute in this instance changed in hundredth of seconds

12.2 Vendor specific object classes

The LioN-X EtherNet/IP variants support the following vendor specific object classes:

Object Class	Instances
General Settings Object (0xA0)	0, 1
Channel Settings Object (0xA1)	0, 1 .. 16*

*) The available instances depend on the number of digital channels of the device variant. Up to 16 digital channels and instances are supported.

12.2.1 General Settings Object (0xA0)

Supported services:

Get Attribute Single (0x0E)

Set Attribute Single (0x10)

Class attribute (Instance 0)

Attribute	Name	Access	Data type	Description
1	Revision	Get	UINT	Revision of this object
2	Max. Instance	Get	UINT	Maximum instance number of an object currently created in this class level of the device.

Instance attribute (Instance 1)

Attribute	Name	Access	Data type	Description
1	Quick Connect	Get, Set	BOOL	0: Disable 1: Enable
2	Force Mode Lock	Get, Set	BOOL	0: Disable 1: Enable
3	Web Interface Lock	Get, Set	BOOL	0: Disable 1: Enable
4	Reserved	Get	SINT	–
5	Report UL/UAux Supply Voltage Fault	Get, Set	SINT	0: Disable 1: Enable 2: Auto
6	Report DO Fault without UL/UAux	Get, Set	BOOL	0: Disable 1: Enable
7.. 24	Reserved	Get	SINT	–
25	CIP object configuration lock	Get, Set	BOOL	0: Disable 1: Enable
26	External configuration lock	Get, Set	BOOL	0: Disable 1: Enable
27.. 32	Reserved	Get	SINT	–

12.2.2 Channel Settings Object (0xA1)

Supported services:

Get Attribute Single (0x0E)

Set Attribute Single (0x10)

Class attribute (Instance 0)

Attribute	Name	Access	Data type	Description
1	Revision	Get	UINT	Revision of this object
2	Max. Instance	Get	UINT	Maximum instance number of an object currently created in this class level of the device.

Instance attribute (Instance 1 .. 16)

Attribute	Name	Access	Data type	Description
1	I/O Mapping	Get, Set	SINT	0 .. 15: Bit number of 16 channel process data 16: Inactive
2*	DO Surveillance Timeout	Get, Set	INT	0 .. 255
3*	DO Failsafe	Get, Set	SINT	0: Set Low 1: Set High 2: Hold Last
4*	DO Restart Mode	Get, Set	SINT	0: Disable 1: Enable
6**	DI Logic	Get, Set	SINT	0: Normally Open 1: Normally Close

Attribute	Name	Access	Data type	Description
7**	DI Filter	Get, Set	SINT	0: Disable 1: 1 ms 2: 2 ms 3: 3 ms 4: 6 ms 5: 10 ms 6: 15 ms
8	Reserved			
9**	DI Extension	Get, Set	SINT	0: Disable 1: 8 ms 2: 16 ms 3: 64 ms
10	Channel Mode	Get, Set	SINT	0: Digital Input/Output 1: Digital Output 2: Digital Input 3: Inactive The supported Channel Mode depends on the device variant.

* Only available for channels supporting DO.

** Only available for channels supporting DI.

For information on the ports see chapter [I/O port overview](#) on page 17.

12.3 Message configuration in Rockwell Automation Studio 5000®

Attributes of CIP object classes can be handled in Rockwell Automation Studio 5000® by the *Message instruction*. This requires the selection of the proper message and service type with its respective service code. The attributes can be defined as *Get* or *Set* in the CIP object class ID, the instance ID and attribute ID. The respective data is described in the previous chapters.

The following image shows an example of how to set *Force Mode Lock* (Attribute 2) of the *General Settings Object (0xA0)* with the *Message instruction*:

Message Configuration - MSG_CIP_Object_Attribute

Configuration Communication Tag

Message Type: CIP Generic

Service Type: Set Attribute Single Source: MOD01_ForceModel

Source Length: 1 (Bytes)

Service Code: 10 (Hex) Class: A0 (Hex) Destination Element:

Instance: 1 Attribute: 2 (Hex) New Tag...

Enable Enable Waiting Start Done Done Length: 0

Error Code: Extended Error Code: Timed Out

Error Path: MOD01_IOL_Master Error Text:

OK Abbrechen Übernehmen Hilfe

The channels as in the *Channel Settings Object* are each assigned in ascending order to an instance ID.

Assignment of the channels:

Channel 1	Port X1.ChA	CIP object instance 1
Channel 2	Port X1.ChB	CIP object instance 2
[...]	[...]	[...]
Channel 15	Port X8.ChA	CIP object instance 15
Channel 16	Port X8.ChB	CIP object instance 16

13 Diagnostics processing

13.1 Error of the system/sensor power supply

The voltage value for the incoming system/sensor power supply is also monitored globally. If the voltage drops below approx. 18 V, or exceeds approx. 30 V, an error diagnosis is generated. At least 21 V of U_S supply voltage for the Digital I/O module are required to minimize the risk of internal voltage drops in module.

The green U_S indicator LED is off.

The error diagnosis has no effect on the outputs.



Caution: It must definitely be ensured that the supply voltage, measured at the most remote participant is not below 21 V DC from the perspective of the system power supply.

The following diagnostics are generated in the producing data image:

General diagnostics	Bit	7	6	5	4	3	2	1	0
General Bit	Byte 0	IME	FME	0	0	SCA	SCS	LVA	LVS
	Byte 1	0	0	0	0	0	0	0	0

LVS

Low Voltage System/Sensor Supply

LVA

Low Voltage Actuator Supply

SCS

Short Circuit Sensor

SCA

Short Circuit Actuator/ U_L/U_{Aux}

13.2 Error of the actuator power supply

The voltage value for the incoming auxiliary/actuator power supply is also monitored globally. If *Report U_L/U_{AUX} Supply Voltage Fault* is enabled, an error message is generated when the voltage drops below approx. 18 V or exceeds approx. 30 V. The U_L indicator shows red.

If output channels are set to *High State* and *Report DO Fault without U_L/U_{AUX}* , additional error diagnostics, caused by the voltage failure, are generated on the channels

The following diagnostics are generated in the *producing data image*:

Actuator/ U_{AUX} diagnostics	Bit	7	6	5	4	3	2	1	0
Channel number (fix)	Byte 0	8	7	6	5	4	3	2	1
	Byte 1	16	15	14	13	12	11	10	9

1 .. 16

Actuator/ U_L channel error on channel
1 .. 16

If *Report U_L/U_{AUX} Supply Voltage Fault* is disabled, no U_L or channel diagnostics appear.

13.3 Overload/short-circuit of the I/O port sensor supply outputs

In case of an overload or a short circuit between pin 1 and pin 3 on the ports (X1 .. X8), the following channel-specific diagnostics in the producing data image are generated:

Sensor diagnostics	Bit	7	6	5	4	3	2	1	0
Port number	Byte 0	X8	X7	X6	X5	X4	X3	X2	X1
	Byte 1	0	0	0	0	0	0	0	0

X1 .. 8

Sensor Short Circuit on Port X1 .. X8

13.4 Overload/short circuit of the digital outputs

In case of an overload or a short circuit of an output channel, the following channel-specific diagnostics are generated in the *producing data image*:

Actuator/U _L diagnostics	Bit	7	6	5	4	3	2	1	0
Channel number (fix)	Byte 0	8	7	6	5	4	3	2	1
	Byte 1	16	15	14	13	12	11	10	9

1 .. 16

Actuator/U_L channel error on channel 1 .. 16

A channel error is determined by comparing the target value set by a controller and the physical value of an output channel.

When an output channel is activated (rising edge of the channel state), the channel errors are filtered for the period that is set by the "Surveillance-Timeout" parameter via the configuration of the device. The value of this parameter can range from 0 to 255 ms; the factory setting is 80 ms.

The filter is used to avoid premature error messages when a capacitive load is activated or an inductive load is deactivated, and during other voltage peaks when a status changes.

In static state of the output channel, that is, while the channel is permanently switched on, the filter time between error detection and the diagnosis is typically 5 ms.

14 IIoT functionality

The LioN-X variants offer a number of new interfaces and functions for the optimal integration into existing or future IIoT (Industrial Internet of Things) networks. The devices continue to work as field bus devices which communicate with and are controlled by a PLC (Programmable Logic Controller).

In addition, the devices offer common IIoT interfaces, which enable new communication channels besides the PLC. The communication is performed via IIoT-relevant protocols MQTT and OPC UA. With the help of these interfaces not only all information in a LioN-X device can be read. They also enable its configuration and control, if the user wishes. All interfaces can be configured extensively and offer read-only functionality.

All LioN-X variants provide user administration, which is also applicable for accessing and configuring the IIoT protocols. This allows you to manage all modification options for the device settings via personalized user authorizations.

All IIoT protocols can be used and configured independently of the field bus. It is also possible to use the devices completely without the help of a PLC and control them via IIoT protocols.



Attention: When using the IIoT functionality, a protected local network environment without direct access to the Internet is recommended.

14.1 MQTT

The MQTT (Message Queueing Telemetry Transport) protocol is an open network protocol for machine-to-machine communication, which provides the transmission of telemetric data messages between devices. The integrated MQTT client allows the device to publish a specific set of information to an MQTT broker.

The publishing of messages can either occur periodically or be triggered manually.

14.1.1 MQTT configuration

In **delivery state**, MQTT functions are **disabled**. The MQTT client can be configured either using the Web interface or directly via a JSON object sent in an HTTP request. For more information see chapter [MQTT configuration - Quick start guide](#) on page 122.

The configuration URL is:

```
http://[ip-address]/w/config/mqtt.json
```

The configuration can also read back as a JSON file:

```
http://[ip-address]/r/config/mqtt.json
```

The configuration is a JSON object. Each JSON member is a configuration element. The object must not contain all elements. Only the provided elements will be changed. The configuration changes apply only after a device restart.

The following configuration elements are available (default values in bold):

Element	Data type	Description	Example data
mqtt-enable	boolean	Master switch for the MQTT client.	true / false
broker	string	IP address of the MQTT Broker	" 192.168.1.1 "
login	string	Username for MQTT Broker	"admin" (Default: null)
password	string	Password for MQTT Broker	"private" (Default: null)
port	number	Broker port	1883
base-topic	string	Base topic	"iomodule_[mac]" (Default: " lionx ")
will-enable	boolean	If true, the device provides a last will message to the broker	true / false
will-topic	string	The topic for the last will message.	(Default: null)
auto-publish	boolean	If true, all enabled domains will be published automatically in the specified interval.	true / false
publish-interval	number	The publish interval in ms if auto-publish is enabled. Minimum is 250 ms.	2000
publish-identity	boolean	If true, all identity domain data will be published	true / false
publish-config	boolean	If true, all config domain data will be published	true / false
publish-status	boolean	If true, all status domain data will be published	true / false
publish-process	boolean	If true, all process domain data will be published	true / false
commands-allowed	boolean	Master switch for MQTT commands. If false, the device will not subscribe to any command topic, even if specific command topics are activated below.	true / false
force-allowed	boolean	If true, the device accepts force commands via MQTT.	true / false
reset-allowed	boolean	If true, the device accepts restart and factory reset commands via MQTT.	true / false
config-allowed	boolean	If true, the device accepts configuration changes via MQTT.	true / false

Element	Data type	Description	Example data
qos	number	Selects the "Quality of Service" status for all published messages.	0 = At most once 1 = At least once 2 = Exactly once

Table 15: MQTT configuration

MQTT response:

The resulting response is a JSON object with a "status" field. Status should be "0" if no error occurred and "-1" if there is an error.

In case of an error, the response contains an error array.

The error array contains an error object for each error occurred. The object consists of a field "Element" which names the config element which caused the error, and a field "Message" for the error message.

- ▶ A malformed JSON object produces an error.
- ▶ Not existing parameters produce an error.
- ▶ Parameters with a wrong data type produce an error.

It is not allowed to write all available parameters at once. You may write only one or a limited number of parameters.

Examples:

```
{ "status": -1, "error": [{"Element": "publish-interval", "Message": "Integer
expected"}]}

{ "status": 0}

{ "status": -1, "error": [{"Element": "root", "Message": "Not a JSON
object"}]}
```

For more information see chapter [MQTT topics](#) on page 107.

14.1.2 MQTT topics

MQTT mainly relates to topics. All messages are attached to a topic which adds context to the message itself. Topics may consist of a string and they are allowed to contain slashes (/). In topic filters, there also wildcard symbols like e.g. (#) allowed.

14.1.2.1 Base topic

For all LioN-X variants there is a configurable Base topic which is the prefix for all topics. The Base topic can be chosen freely by the user. The Base topic can also contain selected variables as shown in [Table 16: Base topic variables](#) on page 107.

Variables in the Base topic have to be written in brackets ("[]"). The following variables are possible:

Variable	Description
mac	The MAC address of the device
name	The name of the device
order	The ordering number of the device
serial	The serial number of the device
ip0 ip1 ip2 ip3	IP address octets

Table 16: Base topic variables

Example:

The Base topic "io_[mac]" translates to "io_A3B6F3F0F2F1".

All data is organized in domains. The domain name is the first level in the topic after the Base topic. Note the following notation:

Base-Topic/domain/....

There are the following domains:

Domain name	Definition	Example content
identity	All fixed data which is defined by the used hardware and which cannot be changed by configuration or at runtime.	Device name, ordering number, MAC address, port types, port capabilities and more.
config	Configuration data which is commonly loaded once at startup, mostly by a PLC.	IP address, port modes, input logic, failsafe values and more.
status	All (non-process) data which changes quite often in normal operation.	Bus state, diagnostic information, Device status and data.
process	All process data which is produced and consumed by the device itself or by attached devices.	Digital inputs, digital outputs, cyclic data.

Table 17: Data domains

There is often one topic used for all gateway related information and topics for each port. All identity topics are published just once at start-up, because this information should never change. All other topics are published either in a fixed interval or just triggered manually, according to the configuration.

Topic	Content examples	Total publish count	Publish interval
[base-topic]/identity/gateway	Name, ordering number, MAC, vendor, I&M etc.	1	Startup
[base-topic]/identity/port/n	Port name, port type	8	Startup
[base-topic]/config/gateway	Configuration parameters, ip address etc.	1	Interval
[base-topic]/config/port/n	Port mode, data storage, mapping, direction	8	Interval
[base-topic]/status/gateway	Bus state, device diagnosis, master events	1	Interval
[base-topic]/status/port/n	Port or channel diagnosis, state	8	Interval
[base-topic]/process/gateway	All Digital IN/OUT	1	Interval

Table 18: Data model

An MQTT client which wants to subscribe to one or more of these topics can also use wildcards.

Full topic	Description
[base-topic]/identity/gateway	Receive only identity objects for the gateway
[base-topic]/identity/#	Receive all data related to the identity domain
[base-topic]/status/port/5	Receive only status information for port number 5
[base-topic]/+/port/2	Receive information of all domains for port number 2
[base-topic]/config/#	Receive config data for the gateway and all ports.

Table 19: Use case examples

14.1.2.2 Publish topic

Overview of all publish JSON data for the defined topics:

Identity/gateway	
Key	Data type
product_name	json_string
ordering_number	json_string
device_type	json_string
serial_number	json_string
mac_address	json_string
production_date	json_string
fw_version	json_string
hw_version	json_string
family	json_string
location	json_string
country	json_string
fax	json_string
vendor_name	json_string
vendor_address	json_string
vendor_phone	json_string
vendor_email	json_string
vendor_techn_support	json_string
vendor_url	json_string

Table 20: Identity/gateway

Config/gateway				
Key	Data type	Range	Default value	Remarks
fieldbus_protocol	json_string	PROFINET EtherNet/IP EtherCAT® Modbus TCP CC-Link IE Field Basic		
network_configuration	json_string	PROFINET: ▶ DCP ▶ Manual EtherNet/IP: ▶ Manual ▶ Rotary ▶ DHCP EtherCAT®: ▶ Manual Modbus TCP: ▶ Manual ▶ DHCP ▶ Rotary CC-Link IE Field Basic: ▶ Manual ▶ Rotary		
rotary_switches	json_integer	0 .. 999		
ip_address	json_string		192.168.1.1	
subnet_mask	json_string		255.255.255.0	
report_ul_alarm	json_boolean	true / false	true	
report_do_fault_without_ul	json_boolean	true / false	false	
force_mode_lock	json_boolean	true / false	false	
web_interface_lock	json_boolean	true / false	false	
fast_startup	json_boolean	true / false	false	PROFINET and EIP only

Config/gateway				
Key	Data type	Range	Default value	Remarks
dcu_autostart	json_boolean	true / false	false	

Table 21: Config/gateway

Status/gateway				
Key	Data type	Range	Default value	Remarks
protocol	json_string	PROFINET: ▶ UNKNOWN ▶ OFFLINE ▶ STOP ▶ IDLE ▶ OPERATE EtherNet/IP: ▶ CONNECTED ▶ DISCONNECTED EtherCAT®: ▶ PREOP ▶ SAFEOP ▶ OP ▶ INIT ▶ UNKNOWN Modbus TCP: ▶ No Connections ▶ Connected CC-Link IE Feld Basic: ▶ ON ▶ STOP ▶ DISCONNECTED ▶ ERROR		
system_voltage_fault	json_boolean	true / false		
actuator_voltage_fault	json_boolean	true / false		
internal_module_error	json_boolean	true / false		
simulation_active_diag	json_boolean	true / false		
us_voltage	json_integer	0 .. 32		in Volts
ul_voltage	json_integer	0 .. 32		in Volts
forcemode_enabled	json_boolean	true / false		

Table 22: Status/gateway

Process/gateway				
Key	Data type	Range	Default value	Remarks
Input_data	json_integer[]			
output_data	json_integer[]			

Table 23: Process/gateway

Identity/port/1 .. 8				
Key	Data type	Range	Default value	Remarks
port	json_integer	1 .. 8		
type	json_string	Digital Input DIO Digital Output DIO Pin 4 Only DI Pin 4 Only DO Pin 4 Only Not available Unknown		
max_output_power_cha	json_string	2.0_mA 0.5_mA		
max_output_power_chb	json_string	2.0_mA 0.5_mA		
channel_cha	json_string	Digital Input Digital Output DIO Digital Input/Output Not available Unknown		
channel_chb	json_string	Digital Input Digital Output DIO Digital Input/Output Not available Unknown		

Table 24: Identity/port/1 .. 8

Config/port/1 .. 8				
Key	Data type	Range	Default value	Remarks
port	json_integer	1 .. 8		
direction_cha	json_string	Output Input Inactive DIO Unknown		
direction_chb	json_string	Output Input Inactive DIO Unknown		
restart_mode_cha	json_string	Manual Auto		
restart_mode_chb	json_string	Manual Auto		
input_polarity_cha	json_string	NO NC		
input_polarity_chb	json_string	NO NC		
input_filter_cha	json_integer			ms
input_filter_chb	json_integer			ms
failsafe_cha	json_string	set_low set_high hold_last	set_low	
failsafe_chb	json_string	set_low set_high hold_last	set_low	
surveillance_timeout_cha	json_integer	0 .. 255	80	
surveillance_timeout_chb	json_integer	0 .. 255	80	

Table 25: Config/port/1 .. 8

Status/port/1 .. 8				
Key	Data type	Range	Default value	Remarks
port	json_integer	1 .. 8		
physical_state_cha	json_integer	0 .. 1		
physical_state_chb	json_integer	0 .. 1		
actuator_short_circuit_cha	json_boolean	true / false		
actuator_short_circuit_chb	json_boolean	true / false		
sensor_short_circuit	json_boolean	true / false		

Table 26: Status/port/1 .. 8

14.1.2.3 Command topic (MQTT Subscribe)

The main purpose of MQTT is to publish data from the device to a broker. This data can then be received by any subscriber who is interested in this data. But also the other way round is possible. The device can subscribe to a topic on the broker and is then able to receive data. This data can contain configuration or forcing data. This allows the user to fully control a device via MQTT only, without using other ways of communication like Web or REST.

If the configuration allows commands in general, the device subscribes to special Command topics on which it can receive commands from other MQTT clients. The Command topic is based upon the Base topic. It always has the following form:

```
[base-topic]/command
```

After the Command topic, there are fixed topics for different writeable objects. The data format of the MQTT payload is always JSON. It is possible to set only a subset of the possible objects and fields.

[...]/forcing

Use the Command topic `[base-topic]/command/forcing` for *Force object* data. The *Force object* can contain any of the following properties:

Property	Data type	Example values	Remarks
forcemode	boolean	true / false	Forcing Authority: on/off
digital	array (Table 28: Force object: Digital on page 119)		

Table 27: Force object properties

For the *Force object* property `digital`, there are several value specifications arrayed:

Property	Data type	Example values	Remarks
port	integer	1, 2, 5	
channel	string	"a", "b"	
force_dir	string	"out", "in", "clear"	
force_value	integer	0, 1	

Table 28: *Force object: Digital*

[...]/config

Use the Command topic `[base-topic]/command/config` for *Config object* data. The *Config object* can contain any of the following properties:

Property	Data type	Example values	Remarks
portmode	array (Table 30: Config object: Portmode on page 120)		
ip_address	string	"192.168.1.5"	
subnet_mask	string	"255.255.255.0"	
gateway	string	"192.168.1.100"	

Table 29: *Config object properties*

For the *Config object* property `portmode`, there are several value specifications arrayed:

Property	Data type	Example values	Remarks
port	integer	2	
channelA*	string	"dio", "di", "do", "off"	
channelB*	string	"dio", "di", "do", "off"	
inlogicA	string	"no", "nc"	
inlogicB	string	"no", "nc"	
filterA	integer	3	input filter in ms
filterB	integer	3	input filter in ms
autorestartA	boolean		
autorestartB	boolean		

Table 30: Config object: Portmode

*channelA = Pin 4, channelB = Pin 2

[...]/reset

Use the Command topic `[base-topic]/command/reset` for *Reset object* data about restart and factory reset issues. The *Reset object* can contain any of the following properties:

Property	Data type	Example values	Remarks
factory_reset	boolean	true / false	
system_reset	boolean	true / false	

Table 31: Reset object properties

[...]/publish

Use the Command topic `[base-topic]/command/publish` for *Publish object* data.

Trigger publish of all topics manually (can be used when auto publish is off or long interval is set).

14.1.3 MQTT configuration - Quick start guide



Attention: Belden Deutschland GmbH is not responsible for any content of the referenced Web pages and provides no warranty for any functionality of the named third party software.

14.1.3.1 MQTT configuration via JSON

1. Depending on your application case, download and install *Insomnia* or a comparable application: <https://insomnia.rest/download/>

2. Configure MQTT:

POST: [IP-address]/w/config/mqtt.json

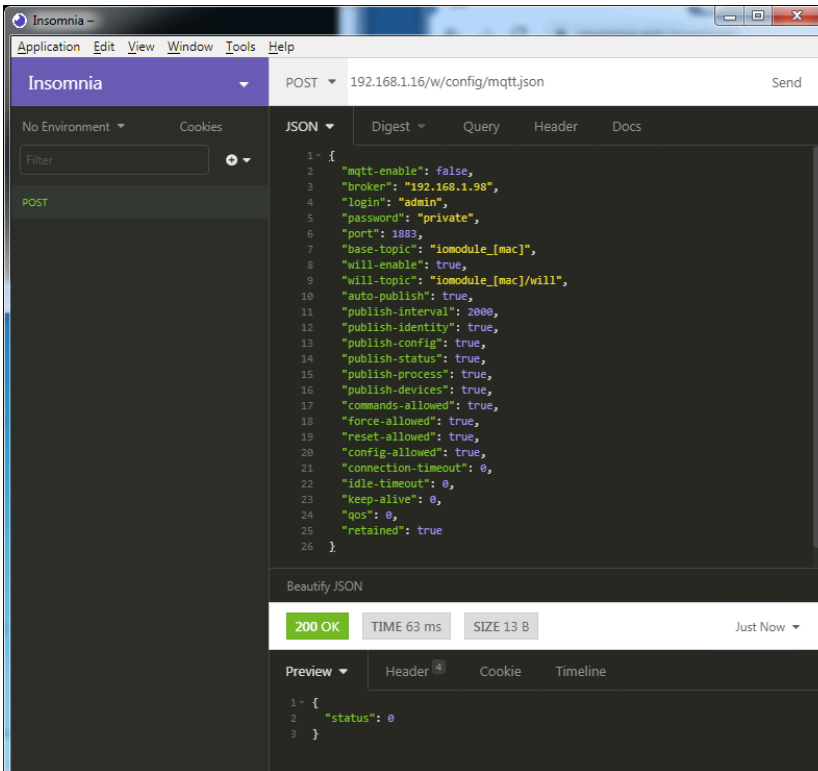

3. Read MQTT:

GET: [IP-address]/r/config/mqtt.json

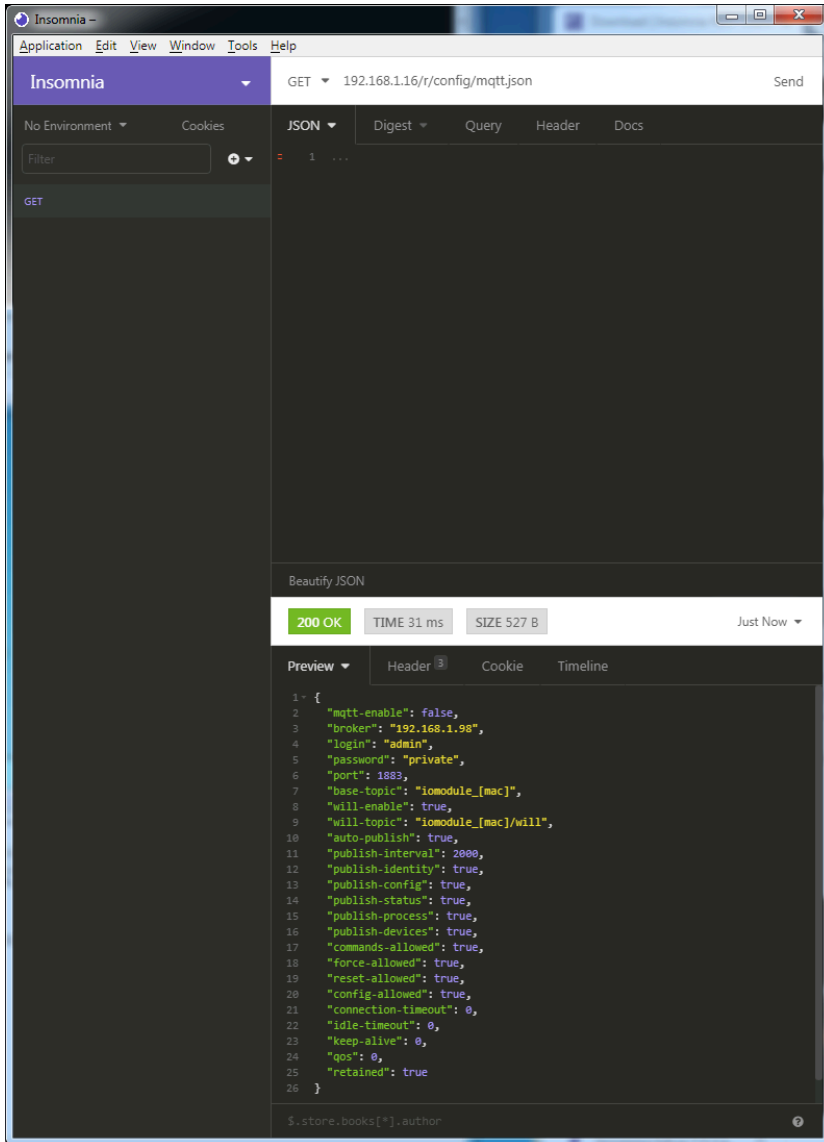

The screenshot shows the Insomnia REST client interface. The URL bar displays the request: GET 192.168.1.16/r/config/mqtt.json. The response status is 200 OK, with a response time of 31 ms and a size of 527 B. The response body is a JSON object, which is displayed in the preview pane below the status bar. The JSON object contains various MQTT configuration parameters.

```
1 {
2   "mqtt-enable": false,
3   "broker": "192.168.1.98",
4   "login": "admin",
5   "password": "private",
6   "port": 1883,
7   "base-topic": "iomodule_[mac]",
8   "will-enable": true,
9   "will-topic": "iomodule_[mac]/will",
10  "auto-publish": true,
11  "publish-interval": 2000,
12  "publish-identity": true,
13  "publish-config": true,
14  "publish-status": true,
15  "publish-process": true,
16  "publish-devices": true,
17  "commands-allowed": true,
18  "force-allowed": true,
19  "reset-allowed": true,
20  "config-allowed": true,
21  "connection-timeout": 0,
22  "idle-timeout": 0,
23  "keep-alive": 0,
24  "qos": 0,
25  "retained": true
26 }
```

14.2 OPC UA

OPC Unified Architecture (OPC UA) is a platform-independent standard with a service-oriented architecture for communication in and with industrial automation systems.

The OPC UA standard is based on the client-server principle and lets machines and devices, regardless of any preferred field bus, communicate horizontally among each other as well as vertically to the ERP system or the cloud. Lion-X provides an OPC UA server on field device level, with which an OPC UA client can connect for information exchange secure in transmission.

14.2.1 OPC UA configuration

In **delivery state**, OPC UA functions are **disabled**. The OPC UA Server can be configured either using the Web interface or directly via a JSON Object sent in an HTTP request.

The configuration URL is:

```
http://[ip-address]/w/config/opcua.json
```

The configuration can also read back as a JSON file:

```
http://[ip-address]/r/config/opcua.json
```

The configuration is a JSON object. Each JSON member is a configuration element. The object must not contain all elements. Only the provided elements will be changed. All configuration changed applies only after a device restart.

Tree overview of OPC UA objects:

- Gateway
 - Identity
 - Name
 - MAC
 - Ordering Number
 - Production Date
 - Capabilities
 - Firmware Versions
 - Status (r)
 - US present
 - UL present
 - US diag
 - UL diag
 - US Voltage
 - UL Voltage
 - IME
 - Forcemode Diag
 - Rotary positions
 - Forcing (r)
 - Forcing active
 - Forcing client
 - OwnForcing flag
 - Config (rw)
 - IP Config
 - suppressActuatorDiagWithoutUL
 - suppressUSDiag
 - suppressULDiag
 - quickConnect
 - Process (r)
 - Digital Inputs
 - Digital Outputs
 - Producing Data (to PLC)
 - Consuming Data (from PLC)
 - Valid masks
 - Commands (w)
 - Restart
 - Factory Reset
 - Forcemode enable
- Ports
 - Port n ("X1"- "X8")
 - Identity
 - Port Name
 - Port Type
 - Channel m ("Pin 4" / "Pin 2")
 - Identity (r)
 - Channel Name
 - Channel Type
 - MaxOutputCurrent
 - Status (r)
 - Actuator Diag
 - Actuator Voltage
 - Actuator Current
 - Channel Failsafe flag
 - Config (rw)
 - Surveillance Timeout
 - Failsafe Config
 - Channel Direction
 - Channel Current Limit
 - Auto Restart
 - InputFilterTime
 - InputLogic
 - Process (r)
 - Output Bit
 - Input Bit
 - Consuming Bit
 - Producing Bit
 - Forcing (rw)
 - Force channel on/off
 - Force value on/off
 - Simulate channel
 - Simulate value
 - Status (r)
 - Pin 1 Short Circuit Dia

All configuration elements are optional and do not need a specific order. Not every element is required to be sent. This means that only configuration changes will be taken over.

Optional: The configuration parameters of OPC UA can be set directly via the Web interface. It is possible to download the Web interface for sharing with other devices.

Response:

The resulting response is a JSON object with a status field. Status should be "0" if no error occurred and "-1" if there is an error.

In case of an error, the response contains an error array.

The error array contains an error object for each error occurred. The object consists of a field "Element" which names the config element which caused the error, and a field "Message" for the error message.

Examples:

```
{ "status": -1, "error": [{"Element": "upcua-enable", "Message": "Boolean
expected"}]}

{ "status": 0 }

{ "status": -1, "error": [{"Element": "root", "Message": "Not a JSON
object"}]}
```

14.2.1.1 Gateway objects

Identity

Name	Data type	Example
Device Name	UA_STRING	
Device ID	UA_STRING	
MAC address	UA_STRING	
Ordering Number	UA_STRING	
Serial Number	UA_STRING	
Production Date	UA_STRING	
Hardware Version	UA_STRING	
App Firmware Version	UA_STRING	
Fieldbus Firmware Version	UA_STRING	
IO Firmware Version	UA_STRING	
Running Fieldbus	UA_STRING	
Forcemode supported	UA_BOOLEAN	Forcing supported by module variant

Status (read)

Name	Data type	Unit	Example
US present	UA_BOOLEAN		
UL present	UA_BOOLEAN		
US diagnosis	UA_BOOLEAN		
UL diagnosis	UA_BOOLEAN		
Internal Module Error diag	UA_BOOLEAN		

Name	Data type	Unit	Example
Forcemode diag	UA_BOOLEAN		
US voltage	UA_DOUBLE	V	23.2
UL voltage	UA_DOUBLE	V	22.9
Rotary position	UA_UINT16		343

Forcing (read)

Name	Data type	Example
Forcing active	UA_BOOLEAN	
Forcing client	UA_STRING	if forcemode is not active, string is empty
Own Forcing	UA_BOOLEAN	Indicates if OPC UA is currently forcing
Forcing possible	UA_BOOLEAN	true if forcing by OPC UA is possible
Forcemode lock	UA_BOOLEAN	Forcing locked by PLC

Config (read + write)

Name	Data type	Example
IP address	UA_STRING	
Subnet Mask	UA_STRING	
Default Gateway IP	UA_STRING	
Suppress US diag	UA_BOOLEAN	
Suppress UL diag	UA_BOOLEAN	
Suppress Actuator Diag w/o UL	UA_BOOLEAN	
QuickConnect	UA_BOOLEAN	

Process (read)

Name	Data type	Example
Input Data	UA_UINT16	ioInput for all channels
Output Data	UA_UINT16	ioOutput for all channels
Consuming Data	UA_UINT16	Data from the PLC to the device
Producing Data	UA_UINT16	Data from the device to the PLC

Commands (write)

Name	Arguments	Return	Example
Restart	void	UA_INT32	
Factory reset	void	UA_INT32	
Forcemode enable	void	UA_INT32	
Forcemode disable	void	UA_INT32	

14.2.1.2 Ports objects

Identity

Name	Data type	Example
Name	UA_STRING	"X1"
Type	UA_STRING	"DIO"

Channel *m* ("Pin 4" / "Pin 2")

See details in [Channel objects](#) on page 131.

Status (read)

Name	Data type	Unit	Example
Sensor Diag	UA_BOOLEAN		

14.2.1.3 Channel objects**Identity (read)**

Name	Data type	Unit	Example
Name	UA_STRING		"X1A"
Type	UA_STRING		"DIO"
MaxOutputCurrent	UA_INT16	mA	1300

Status (read)

Name	Data type	Unit	Example
Actuator Diag	UA_BOOL		
Channel Failsafe	UA_BOOL		

Config (read + write)

Name	Data type	Unit	Example / Remarks
Surveillance Timeout	UA_UINT8	ms	80 ms
Failsafe Config	UA_ENUMERATION		Low Hi Hold Last
Channel Direction	UA_ENUMERATION		DIO Input Output Inactive

Name	Data type	Unit	Example / Remarks
Auto Restart	UA_BOOL		
InputFilterTime	UA_UINT8	ms	3ms
InputLogic	UA_ENUMERATION		NO NC

Process (read)

Name	Data type	Example / Remarks
Output	UA_BOOLEAN	Output type channels only.
Input	UA_BOOLEAN	Input type channels only.
Consuming	UA_BOOLEAN	
Producing	UA_BOOLEAN	

Forcing (read + write)

Name	Data type	Example / Remarks
Force channel	UA_BOOLEAN	Enable forcing with the current force value or disable forcing for this channel. Output type channels only.
Force value	UA_BOOLEAN	When changed by the user it will start forcing with the new value if forcing is enabled for opcua. Output type channels only.
Simulate channel	UA_BOOLEAN	Enable simulation with the current force value or disable simulation for this channel. Input type channels only.

Name	Data type	Example / Remarks
Simulate value	UA_BOOLEAN	<p>When changed by the user it will start simulation with the new value if forcing is enabled for opcua.</p> <p>Input type channels only.</p>

14.2.2 OPC UA address space

OPC UA provides different services on the LioN-X devices with which a client can navigate through the hierarchy of the address space and read or write variables. In addition, the client can monitor up to 10 attributes from the address space for value changes.

A connection to an OPC UA server is established via the endpoint URL:

```
opc.tcp://[ip-address]:[port]
```

Various device data such as MAC address, device settings, diagnostics or status information can be read via *Identity objects*, *Config objects*, *Status objects* and *Process objects*.

Command objects can be read and written. This makes it possible, for example, to transfer new network parameters to the device, to use Force Mode or to reset the entire device to its factory settings.

14.2.3 OPC UA configuration - Quick start guide



Attention: Belden Deutschland GmbH is not responsible for any content of the referenced Web pages and provides no warranty for any functionality of the named third party software.

14.2.3.1 OPC UA configuration via JSON

1. Depending on your application case, download and install *Insomnia* or a comparable application: <https://insomnia.rest/download/>

2. Configure OPC UA:

POST: [IP-address]/w/config/opcuajson

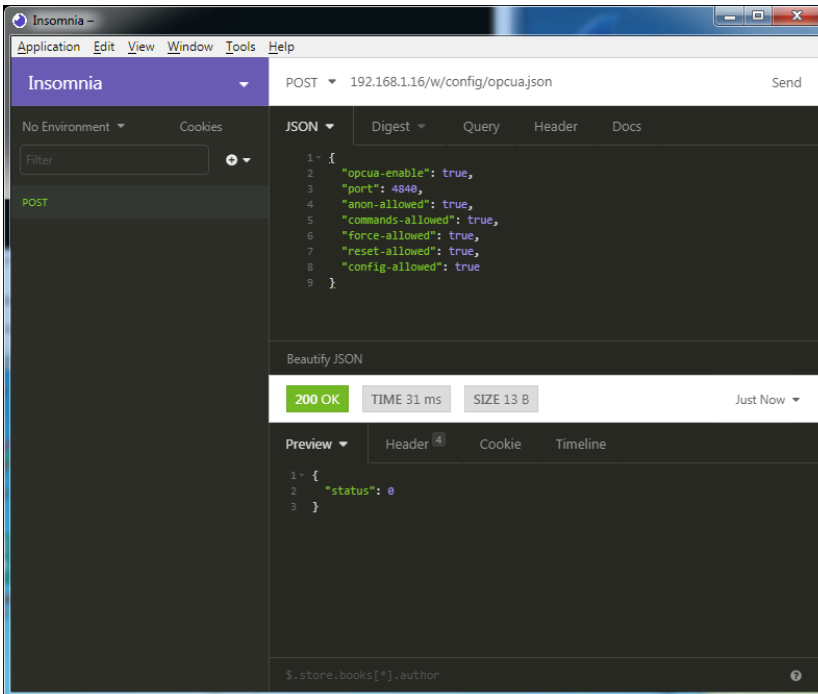

3. Read OPC UA:

GET: [IP-address]/r/config/opcuajson

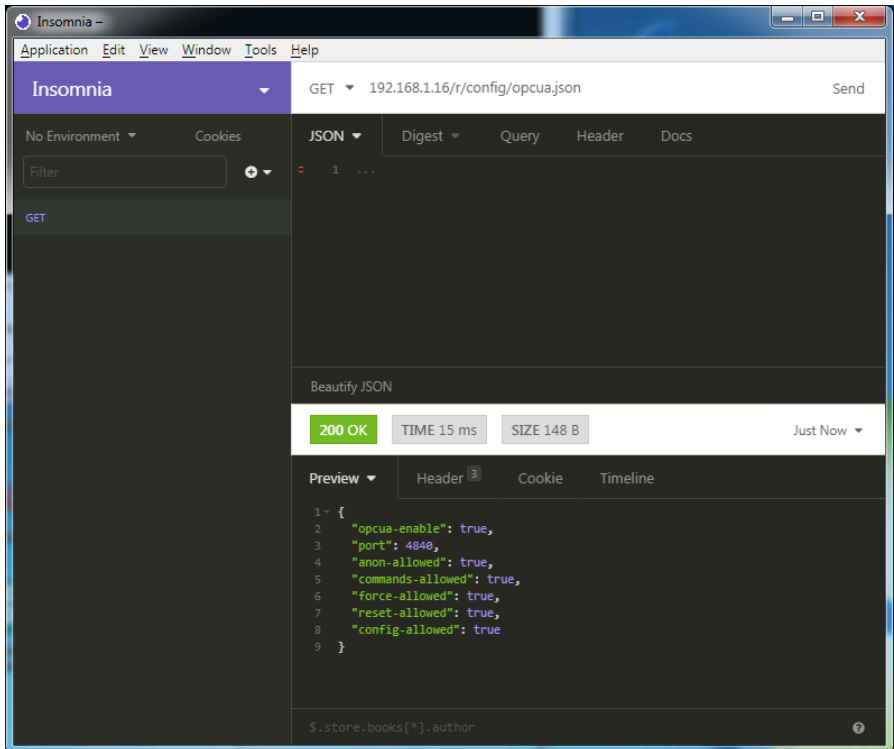

14.3 REST API

The Representational State Transfer – Application Programming Interface (REST API) is a programmable interface which uses HTTP requests to GET and POST data. This enables the access to detailed device information.

For all LiON-X variants, the REST API can be used to read the device status. For the LiON-X multi-protocol variants, the REST API can also be used to write configuration and forcing data.

The customized Belden REST API is described in the following chapters.

14.3.1 Standard device information

Request method:	http GET
Request URL:	<ip>/info.json
Parameters	n.a.
Response format	JSON

The goal of the "Standard device information" request is to get a complete snapshot of the current device status. The format is JSON.

14.3.2 Structure

Name	Data type	Description	Example
name	string	Device name	0980 XLC 3900-121-007D-01F
order-id	string	Ordering number	935715001
fw-version	string	Firmware version	V.11.2.0.0 - 08.08.2024
hw-version	string	Hardware version	V.1.00
mac	string	MAC address of the device	3C B9 A6 F3 F6 05
bus	number	0 = No connection 1 = Connection with PLC	1
failsafe	number	0 = Normal operation 1 = Outputs are in failsafe	0
ip	string	IP address of the device	
snMask	string	Subnet Mask	
gw	string	Default gateway	
rotarys	array of numbers (3)	Current position of the rotary switches: Array element 0 = x1 Array element 1 = x10 Array element 2 = x100	
ulPresent	boolean	True, if there is a UL voltage supply detected within valid range	
usVoltage_mv	number	US voltage supply in mV	
ulVoltage_mv	number	UL voltage supply in mV (only available for devices with UL supply)	
inputs	array of numbers (2)	Real state of digital inputs. Element 0 = 1 Byte: Port X1 Channel A to Port X4 Channel B Element 0 = 1 Byte: Port X5 Channel A to Port X8 Channel B	[128,3]
output	array of numbers (2)	Real State of digital outputs. Element 0 =1 Byte: Port X1 Channel A to port X4 Channel B Element 0 = 1 Byte: Port X5 Channel A to port X8 Channel B	[55,8]

Name	Data type	Description	Example				
consuming	array of numbers (2)	Cyclic data from PLC to device					
producing	array of numbers (2)	Cyclic data from device to PLC					
diag	array of numbers (4)	Diagnostic information <table border="1" style="width: 100%; border-collapse: collapse;"> <tr> <td style="padding: 5px;"> Element 0 = 1 Byte: Bit 7: Internal module error (IME) Bit 6: Forcemode active Bit 3: Actuator short Bit 2: Sensor short Bit 1: U_L fault Bit 0: U_S fault </td> </tr> <tr> <td style="padding: 5px;"> Element 1 = 1 Byte: Sensor short circuit ports X1 .. X8. </td> </tr> <tr> <td style="padding: 5px;"> Element 2 = 1 Byte: Actuator short circuit ports X1 Channel A to X4 Channel B </td> </tr> <tr> <td style="padding: 5px;"> Element 3 = 1 Byte: Actuator short circuit ports X5 Channel A to X8 Channel B </td> </tr> </table>	Element 0 = 1 Byte: Bit 7: Internal module error (IME) Bit 6: Forcemode active Bit 3: Actuator short Bit 2: Sensor short Bit 1: U _L fault Bit 0: U _S fault	Element 1 = 1 Byte: Sensor short circuit ports X1 .. X8.	Element 2 = 1 Byte: Actuator short circuit ports X1 Channel A to X4 Channel B	Element 3 = 1 Byte: Actuator short circuit ports X5 Channel A to X8 Channel B	
Element 0 = 1 Byte: Bit 7: Internal module error (IME) Bit 6: Forcemode active Bit 3: Actuator short Bit 2: Sensor short Bit 1: U _L fault Bit 0: U _S fault							
Element 1 = 1 Byte: Sensor short circuit ports X1 .. X8.							
Element 2 = 1 Byte: Actuator short circuit ports X1 Channel A to X4 Channel B							
Element 3 = 1 Byte: Actuator short circuit ports X5 Channel A to X8 Channel B							
fieldbus	FIELDBUS Object						
FIELDBUS Object							
fieldbus_name	string	Currently used fieldbus					
state	number	Fieldbus state					
state_text	number	Textual representation of fieldbus state: 0 = Unknown 1 = Bus disconnected 2 = Preop 3 = Connected 4 = Error 5 = Stateless					
forcing	FORCING Object	Information about the forcing state of the device					

Name	Data type	Description	Example
channels	Array of CHANNEL (16)	Basic information about all input/output channels	
CHANNEL Object			
name	string	Name of channel	
type	number	Hardware channel type as number: 0 = DIO 1 = Input 2 = Output 3 = Input/Output 4 = Channel not available 5 = Channel not available 6 = Channel not available 7 = Channel not available 8 = Channel not available	
type_text	string	Textual representation of the channel type	
config	number	Current configuration of the channel: 0 = DIO 1 = Input 2 = Output 3 = Channel not available 4 = Deactivated 5 = Channel not available	
config_text	string	Textual representation of the current config	
inputState	boolean	Input data (producing data) bit to the PLC	
outputState	boolean	Output data bit to the physical output pin	
forced	boolean	True, if the output pin of this channel is forced	
simulated	boolean	True, if the input value to the PLC of this channel is simulated	
actuatorDiag	boolean	True, if the output is in short circuit / overload condition	
sensorDiag	boolean	True, if the sensor supply (Pin 1) is in short circuit / overload condition	

Name	Data type	Description	Example
maxOutputCurrent_mA	number	Maximum output current of the output in mA	
current_mA	number	Measured current of the output in mA (if current measurement is available)	
voltage_mV	number	Measured voltage of this output in mV (if voltage measurement is available)	
PORT Object			
port_type	string	Textual representation of the port type	
ds_fault	number	Data storage error number	
ds_fault_text	string	Textual data storage error.	
diag	array of DIAG (n)	Array of port related events	
DIAG Object			
error	number	Error code	
source	string	Source of the current error.	"device" "master"
message	string	Error message	"Supply Voltage fault"
FORCING Object			
forcingActive	boolean	Force mode is currently active	
forcingPossible	boolean	True, if forcing is possible and force mode can be activated	
AuthPossible	boolean	True, if the JSON Interface can obtain forcing authorization	
ownForcing	boolean	True, if forcing is performed by REST API at the moment	
currentClient	string	Current forcing client identifier	
digitalOutForced	array of numbers (2)	The force values of all 16 digital output channels.	
digitalOutMask	array of numbers (2)	The forcing mask of all 16 digital output channels.	
digitalInForced	array of numbers (2)	The force values of all 16 digital input channels.	
digitalInMask	array of numbers (2)	The forcing mask of all 16 digital input channels.	

14.3.3 Configuration and forcing

Method:	POST
URL:	<ip>/w/force.json
Parameters:	None
Post-Body:	JSON Object

Property	Data type	Example values	Description
forcemode	boolean	true / false	Forcing authority on/off
portmode	array (Port mode object)		
digital	array (Digital object)		

Table 32: Root object

Property	Data type	Example values	Remarks
port	integer	0..7	
channel	string	"a","b"	optional default is "a"
direction	string	"dio","di","do", "off"	
inlogica	string	"no","nc"	
inlogicb	string	"no","nc"	

Table 33: Port mode object

Property	Data type	Example values	Remarks
port	integer	0..7	
channel	string	"a","b"	
force_dir	string	"phys_out","plc_in","clear"	optional default is "phys_out"
force_value	integer	0,1	

Table 34: Digital object

14.4 CoAP server

The **Constrained Application Protocol (CoAP)** is a specialized Internet application protocol for constrained networks such as lossy or low power networks. CoAP is useful especially in M2M (Machine to Machine) communication and can be used to translate simplified HTTP requests of low speed networks.

CoAP is based on the Server-Client principle and a service layer protocol that lets nodes and machines communicate with each other. The LioN-X multi-protocol variants provide CoAP server functionalities via a REST API interface over UDP.

14.4.1 CoAP configuration

In delivery state, CoAP functions are *disabled*. The CoAP server can be configured either using the Web interface or directly via a JSON object sent in an HTTP/HTTPS request. For more information see chapter [CoAP configuration - Quick start guide](#) on page 146.

The configuration URL is:

```
http://[ip-address]/w/config/coapd.json
```

The configuration can also read back as a JSON file:

```
http://[ip-address]/r/config/coapd.json
```

The configuration is a JSON object. Each JSON member is a configuration element. The object must not contain all elements. Only the provided elements will be changed. The configuration changes apply only after a device restart.

The following configuration elements are available (default values in bold):

Element	Data type	Description	Example data
enable	boolean	Master switch for the CoAP server	true / false
port	integer (0 to 65535)	Port of the CoAP server	5683

Table 35: CoAP configuration

CoAP response:

The resulting response is a JSON object with a "status" field. Status should be "0" if no error occurred, and "-1" if there is an error.

In case of an error, the response contains an error array.

The error array contains an error object for each error occurred. The object consists of a field "Element" which names the config element that caused the error, and of a field "Message" for the error message.

Examples:

```
{ "status": -1, "error": [{"Element": "upcua-enable", "Message": "Boolean
expected"}]}

{ "status": 0 }

{ "status": -1, "error": [{"Element": "root", "Message": "Not a JSON
object"}]}
```

14.4.2 REST API access via CoAP

A connection to the CoAP server running on the LioN-X multi-protocol variants can be established via the following URL:

```
coap://[ip-address]:[port]/[api]
```

For LioN-X, the following REST API Requests (JSON format) can be accessed via a CoAP endpoint:

Type	API	Note
GET	/r/status.lr	
GET	/r/system.lr	
GET	/info.json"	
GET	/r/config/net.json	
GET	/r/config/mqtt.json	
GET	/r/config/opcu.json	
GET	/r/config/coapd.json	
GET	/r/config/syslog.json	
GET	/contact.json	
GET	/fwup_status	

Table 36: REST API access via CoAP

14.4.3 CoAP configuration - Quick start guide



Attention: Belden Deutschland GmbH is not responsible for any content of the referenced Web pages and provides no warranty for any functionality of the named third party software.

14.4.3.1 CoAP configuration via JSON

1. Depending on your application case, download and install *Insomnia* or a comparable application: <https://insomnia.rest/download/>

2. Configure CoAP:

POST: [IP-address]/w/config/coapd.json

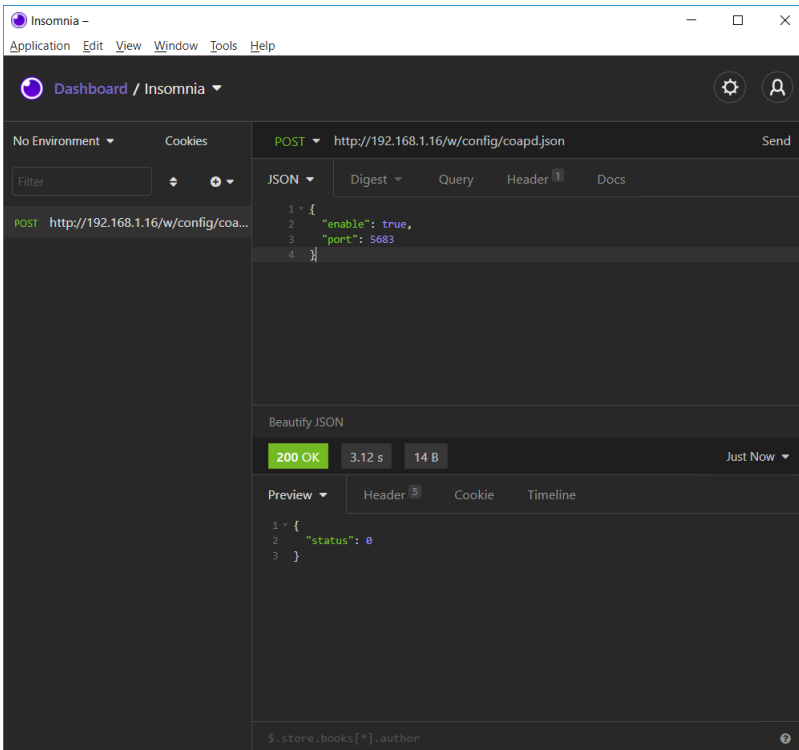

3. Read CoAP configuration:

GET: [IP-address]/r/config/coapd.json

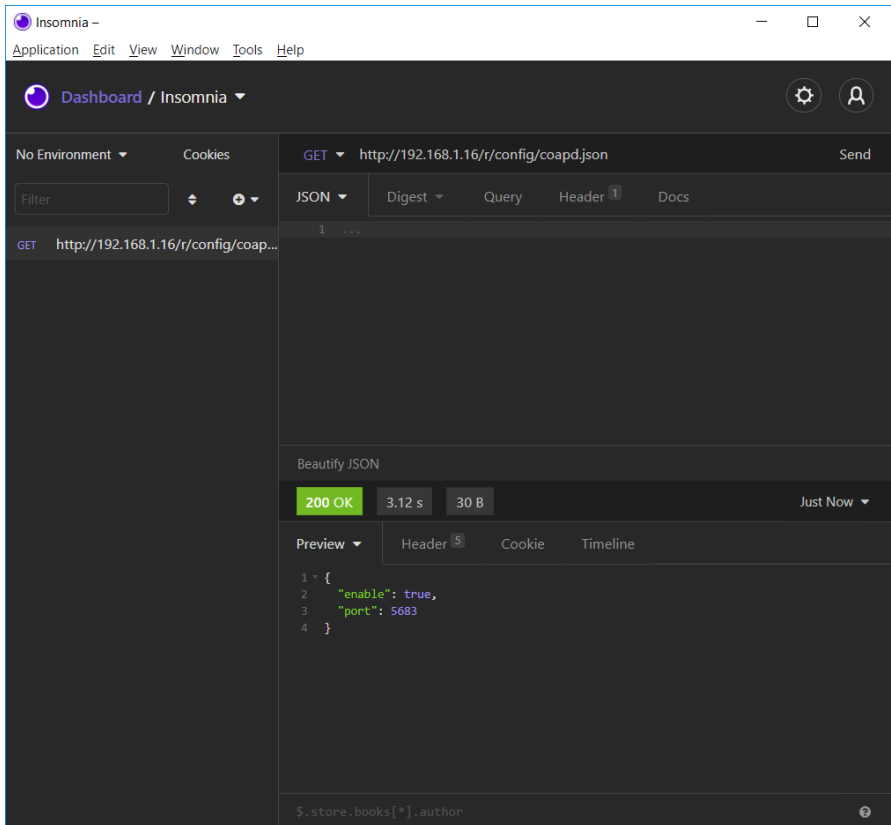

The screenshot displays the Insomnia REST client interface. The top bar shows the application name "Insomnia" and standard window controls. Below the menu bar, the "Dashboard / Insomnia" header is visible. The main workspace is divided into several sections:

- Environment:** "No Environment" is selected.
- Request:** A GET request is defined for the URL `http://192.168.1.16/r/config/coapd.json`. The request body is empty.
- Response:** The response status is **200 OK**, with a response time of **3.12 s** and a body size of **30 B**. The response content is displayed in a JSON format:

```
1 {
2   "enable": true,
3   "port": 5683
4 }
```

At the bottom of the interface, a JSONPath expression `$.store.books[*].author` is visible.

14.5 Syslog

The LioN-X multi-protocol variants provide a Syslog client which can connect with a configured Syslog server and is able to log messages.

Syslog is a platform-independent standard for logging messages. Each message contains a timestamp as well as information about the severity level and the subsystem. The Syslog protocol RFC5424 is based on the Server-Client principle and lets machines and devices send messages in the network and collect them centrally. (For more details on the used syslog standard, please refer to <https://datatracker.ietf.org/doc/html/rfc5424>.)

LioN-X supports the storage of 256 messages in a ring buffer which are sent to the configured Syslog server. When the ring is full with 256 messages, the oldest message is always replaced by the newly arriving messages. All messages can be saved on the Syslog server. The Syslog client will not store any message permanently.

14.5.1 Syslog configuration

In **delivery state**, Syslog functions are **disabled**. The Syslog client can be configured either using the Web interface or directly via a JSON object sent in an HTTP/HTTPS request. For more information see chapter [Syslog configuration - Quick start guide](#) on page 151.

The configuration URL is:

```
http://[ip-address]/w/config/syslog.json
```

The configuration can also read back as a JSON file:

```
http://[ip-address]/r/config/syslog.json
```

The configuration is a JSON object. Each JSON member is a configuration element. The object must not contain all elements. Only the provided elements will be changed. The configuration changes apply only after a device restart.

The following configuration elements are available (default values in bold):

Element	Data type	Description	Example data
syslog-enable	boolean	Master switch for the Syslog client	true / false
global-severity	integer	<u>Severity level of Syslog client</u> 0 – Emergency 1 – Alert 2 – Critical 3 – Error 4 – Warning 5 – Notice 6 – Info 7 – Debug The client will log all messages of severity according to the setting, including all below levels.	0/1/2/ 3 /4/5/6/7
server-address	string (IP address)	IP address of the Syslog server	192.168.0.51 (Default: null)
server-port	integer (0 to 65535)	Server port of the Syslog server	514
server-severity	integer (0 to 7)	<u>Severity level of Syslog server</u> 0 – Emergency 1 – Alert 2 – Critical 3 – Error 4 – Warning 5 – Notice 6 – Info 7 – Debug	0/1/2/ 3 /4/5/6/7

Table 37: Syslog configuration

Syslog response:

The resulting response is a JSON object with a "status" field. Status should be "0" if no error occurred, and "-1" if there is an error.

In case of an error, the response contains an error array.

The error array contains an error object for each error occurred. The object consists of a field "Element" which names the config element that caused the error, and of a field "Message" for the error message.

Examples:

```
{ "status": -1, "error": [{"Element": "upcua-enable", "Message": "Boolean
expected"}]}

{ "status": 0 }

{ "status": -1, "error": [{"Element": "root", "Message": "Not a JSON
object"}]}
```

14.5.2 Syslog configuration - Quick start guide



Attention: Belden Deutschland GmbH is not responsible for any content of the referenced Web pages and provides no warranty for any functionality of the named third party software.

14.5.2.1 Syslog configuration via JSON

1. Depending on your application case, download and install *Insomnia* or a comparable application: <https://insomnia.rest/download/>

2. Configure Syslog:

POST: [IP-address]/w/config/syslog.json

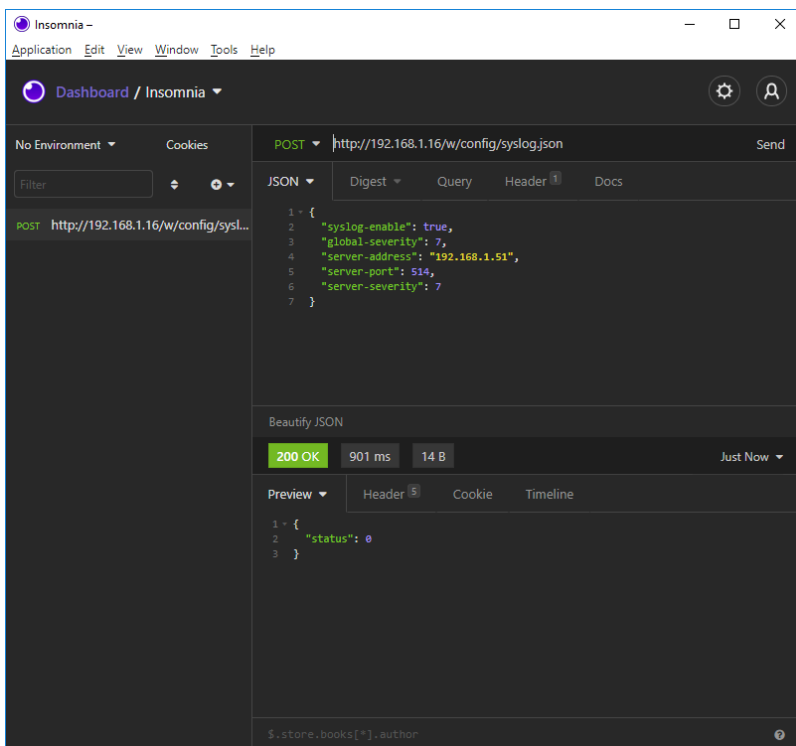

3. Read Syslog configuration:

GET: [IP-address]/r/config/syslog.json

The screenshot shows the Insomnia REST client interface. The top bar displays the application name "Insomnia" and standard window controls. Below the menu bar, the "Dashboard / Insomnia" header is visible. The main interface is divided into several sections:

- Left Panel:** Shows the current environment as "No Environment" and a "Cookies" section. A "Filter" input field is present. The request method is "GET" and the URL is "http://192.168.1.16/r/config/syslog.json".
- Right Panel:** Displays the response details for the GET request. The status is "200 OK", the response time is "64.2 ms", and the size is "118 B". The response body is shown in a "Preview" view, displaying a JSON object with the following structure:

```
1 {
2   "syslog-enable": true,
3   "global-severity": 7,
4   "server-address": "192.168.1.51",
5   "server-port": 514,
6   "server-severity": 7
7 }
```

14.6 Network Time Protocol (NTP)

The LioN-X multi-protocol variants provide an NTP client (version 3) which can connect with a configured NTP server and is able to synchronize the network time at a configurable interval.

NTP is a network protocol which uses UDP datagrams to send and receive timestamps in order to synchronize with a local clock. The NTP protocol RFC1305 is based on the Server-Client principle and exclusively supplies the synchronization with Coordinated Universal Time (UTC). (For more details on the used NTP standard, please refer to <https://datatracker.ietf.org/doc/html/rfc1305>.)

14.6.1 NTP configuration

In **delivery state**, the NTP client is **disabled**. The NTP client can be configured either using the Web interface or directly via a JSON object sent in an HTTP/HTTPS request. For more information see chapter [NTP configuration - Quick start guide](#) on page 155.

The configuration URL is:

```
http://[ip-address]/w/config/ntpc.json
```

The configuration can also read back as a JSON file:

```
http://[ip-address]/r/config/ntpc.json
```

The configuration is a JSON object. Each JSON member is a configuration element. The object must not contain all elements. Only the provided elements will be changed. The configuration changes apply only after a device restart.

The following configuration elements are available (default values in bold):

Element	Data type	Description	Example data
NTP client state	boolean	Master switch for the NTP client	true / false
Server address	string	IP address of the NTP server	192.168.1.50
Server port	integer	Port of the NTP server	123
Update interval	integer	Interval at which the client will connect with the configured NTP server (see table row "Server address"). Note: This value is in seconds.	1/2/10/ 60

Table 38: NTP configuration

NTP response:

The resulting response is a JSON object with a "status" field. Status should be "0" if no error occurred, and "-1" if there is an error.

In case of an error, the response contains an error array.

The error array contains an error object for each error occurred. The object consists of a field "Element" which names the configuration element that caused the error, and of a field "Message" for the error message.

Examples:

```
{ "status": -1, "error": [{"Element": "ntpc-enable", "Message": "Boolean
expected"}] }

{ "status": 0 }

{ "status": -1, "error": [{"Element": "root", "Message": "Not a JSON
object"}] }
```

14.6.2 NTP configuration - Quick start guide



Attention: Belden Deutschland GmbH is not responsible for any content of the referenced Web pages and provides no warranty for any functionality of the named third party software.

14.6.2.1 NTP configuration via JSON

1. Depending on your application case, download and install *Insomnia* or a comparable application: <https://insomnia.rest/download/>

2. Configure NTP:

POST: [IP-address]/w/config/ntp.json

The screenshot shows the Insomnia REST client interface. The top bar indicates the application is running in "No Environment" mode. The main workspace is divided into several sections:

- Request Section:** Shows a POST request to `http://192.168.1.16/w/config/ntp.json`. The request body is a JSON object:

```
1 {
2   "enable": false,
3   "server-address": "192.168.1.8",
4   "server-port": 123,
5   "update-interval": 5
6 }
```
- Response Section:** Shows a successful response with a status of `200 OK`, a response time of `75.4 ms`, and a response size of `14 B`. The response body is a JSON object:

```
1 {
2   "status": 0
3 }
```

3. Read NTP configuration:

GET: [IP-address]/r/config/ntpc.json

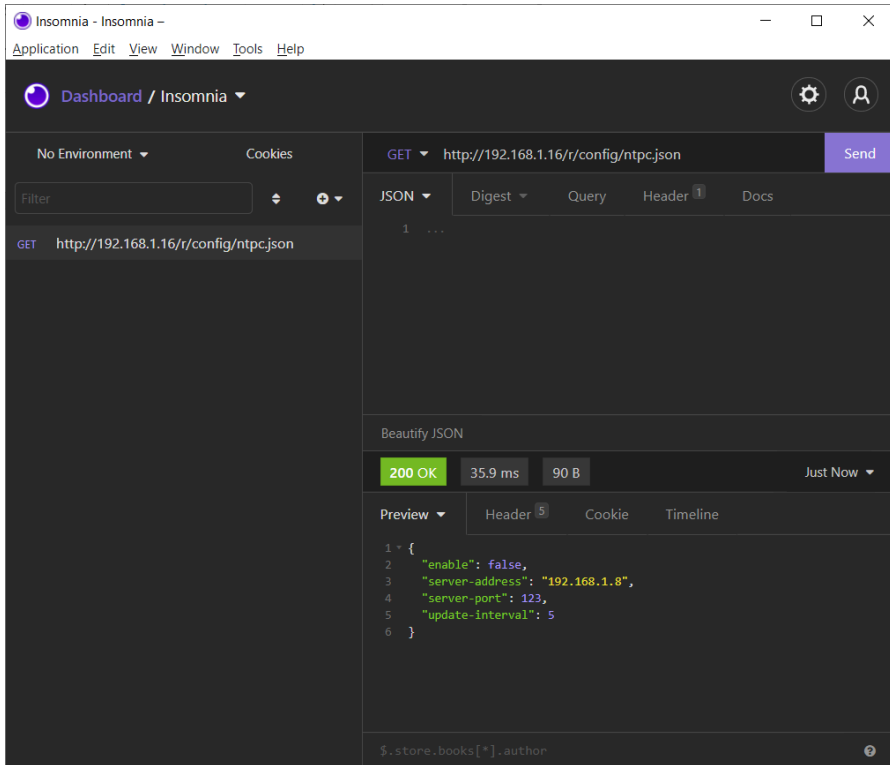

The screenshot shows the Insomnia REST client interface. The top bar displays the application name "Insomnia - Insomnia" and standard window controls. Below the bar, the "Dashboard / Insomnia" section is visible. The main workspace is divided into several panes:

- Left Pane:** Shows the request details for "GET http://192.168.1.16/r/config/ntpc.json".
- Top Right:** A "Send" button is visible.
- Response Tabs:** "JSON" is selected, showing the response body.
- Status Bar:** Displays "200 OK", "35.9 ms", and "90 B".
- Preview Pane:** Shows the JSON response body:

```
1 {
2   "enable": false,
3   "server-address": "192.168.1.8",
4   "server-port": 123,
5   "update-interval": 5
6 }
```

At the bottom of the preview pane, there is a JSONPath filter: `$.store.books[*].author`.

15 The integrated Web server

All device variants are equipped with an integrated Web server which makes functions for the device configuration and the display of status and diagnostic information available via a Web interface.

The Web interface provides an overview of the configuration and status of the device. It is also possible to use the Web interface to trigger a reboot, reset to the factory defaults, or perform a firmware update.

Enter "http://" followed by the IP address, such as "http://192.168.1.5", in your Web browser's address bar. If the status page of the device is not displayed, check your browser and firewall settings.

15.1 LioN-X 0980 XLC... variants

15.1.1 The Status page

The screenshot displays the 'LioN-X Digital Low Current Web Interface' Status page. The interface includes a navigation bar with 'Status', 'Parts', 'System', 'User', and 'Contact' tabs. The 'Status' page is divided into three main sections:

- Device Overview:** A graphical representation of the device showing various ports (X1, X2, X3, X4, X5, X6, X7, X8) and their corresponding LEDs and rotary switches.
- Device Information:** A table providing basic data for the module.

Field	Value
Name	LioN-X Digital 16DIO Low Current
Application Version	11.2.3.51903
Fieldbus Version	1.0.1.0
Bus	OPERATE
Device Diagnosis	
US Voltage	23.2V
UL Voltage	23.5V
Force mode	Forcing is locked. <input type="button" value="Locked"/>
- Port Information:** A table showing the configuration and state of the I/O ports.

Channel	Type	Configuration	State	Dia	Details
X1 A	DIO	DIO	LOCK		ⓘ
X1 B	DIO	DIO	LOCK		
X2 A	DIO	DIO	LOCK		ⓘ
X2 B	DIO	DIO	LOCK		
X3 A	DIO	DIO	LOCK		ⓘ
X3 B	DIO	DIO	LOCK		
X4 A	DIO	DIO	LOCK		ⓘ
X4 B	DIO	DIO	LOCK		
X5 A	DIO	DIO	LOCK		ⓘ
X5 B	DIO	DIO	LOCK		
X6 A	DIO	DIO	LOCK		ⓘ
X6 B	DIO	DIO	LOCK		
X7 A	DIO	DIO	LOCK		ⓘ
X7 B	DIO	DIO	LOCK		
X8 A	DIO	DIO	LOCK		ⓘ
X8 B	DIO	DIO	LOCK		

The status page provides a quick overview of the current state of the device.

The left side shows a graphical representation of the module with all its LEDs and the positions of the rotary encoding switches.

The right side shows the "Device Information" table with some basic data for the module; for example, the variant, the cyclic communication status and a diagnostic indicator. The indicator shows whether diagnostics for the module exist.

The "Port Information" table shows the configuration and state of the I/O ports.

15.1.2 The Ports page

LioN-X Digital Low Current Web Interface

Status Ports System User Contact

Port Details

Show details for port

X1 X2 X3 X4 X5 X6 X7 X8

Port Information

Forcemode	Forcemode off
Port	X1
Dia	

Port Diagnosis

- No diagnosis

Pin 4 / Channel A

Type	DIO
Function	DIO
State	On
Output Restart	On
Input Logic	Normally Open
Input Filter	Off

Pin 2 / Channel B

Type	DIO
Function	DIO
State	Off
Output Restart	On
Input Logic	Normally Open
Input Filter	Off

The page shows detailed port information. In the field **Port Diagnosis**, incoming and outgoing diagnostics are displayed as clear text. **Pin 2** and **Pin 4** contain information about the configuration and state of the port.

15.1.3 The System page

LioN-X Digital Low Current Web Interface

Status
Ports
System
User
Contact

System

General Information

Firmware
 Application Version 11.2.3.51903
 Fieldbus Version 1.0.1.0

Device
 Name LioN-X Digital 16DIO Low Current
 Product ID 0980 XLC 3900-121-007D-01F
 Ordering Number 935715001
 Hardware 1.0
 Serial Number 123456
 Production Date 2020-12-24T12:00:00Z

Ethernet
 MAC Address 3C:B9:A6:20:05:30

Network
 Source DCP
 IP-Address 192.168.0.3
 Subnetmask 255.255.255.0
 Gateway 192.168.0.3

Fieldbus
 Name PROFINET
 State OPERATE

IP Settings

IP configuration Manual DHCP

MQTT Config		OPC UA Server Config	
Mqtt state	Disabled	Opua state	Disabled
Broker	192.168.1.1	Port	4840
Port	1883	Anonymous login	Yes
Base Topic	liotx	Listen for Commands	No
Auto Publish	Yes	Process Forcing	No
Publish Interval (ms)	2000	Change config	No
Publish Identity	Yes	Device Reset	No
Publish Config	Yes		
Publish Status	Yes	Syslog	
Publish Process	Yes	Syslog state	Disabled
Publish Devices	No	Global severity	3
Will State	Disabled	Server address	
Listen for Commands	No	Server port	514
Process Forcing	No	Server severity	3
Change Config	No	CoAP	
Device Reset	No	CoAP state	Disabled
QOS	At most once	Port	5683
		NTP	
		NTP client state	Disabled
		Server address	0.0.0.0
		Server port	123
		Update interval	60

License Information

Config upload/download

Choose config file to upload:
 Keine ausgewählt

Restart device

Confirm to restart the device. All connections will be closed.

Reset configuration to factory defaults

Restoring factory settings affects all network parameters, including fieldbus specific settings. All network connections will be closed.

Note: If the module has rotary switches, the new IP address is equivalent to the rotary switch position.

Confirm to reset the device. All configuration data will be overwritten by default values!

Firmware update

System diagnosis

Store timer: ▾

System diagnosis severity: Error Warning Information

The System page shows the basic information for the module like Firmware version, Device information, Ethernet, Network and Fieldbus information.

Config upload/download

With this feature, settings configured via the Web interface can be stored outside the I/O-Device (Download) for later Upload, e.g. after an I/O-Device change.

Config upload/download

Choose config file to upload:

No file selected.

Downloaded config_LioN-X_SN123456_2024-06-03T13-49-09.cfg

Restart Device

The module initializes a software reset.

Reset to Factory Settings

The module restores to the default factory settings.

IP Settings

Use this parameter to change the current IP address of the module.

For PROFINET, this is only useful during commissioning. Normally, the PLC sets the IP address at start-up by detecting the PROFINET module via its device name.

Firmware Update

The module initializes a Firmware update.



Attention: Firmware updates may only be performed in a non-production environment! The I/O data is not updated during the firmware update. As a minimum requirement, the controller must be in operating state “Stop”, or the connection to the controller must be disconnected before the update. The device automatically performs a reset during the update.

For a firmware update choose the *.ZIP container available on our website or ask our support team. Afterwards follow the instructions shown on your screen.

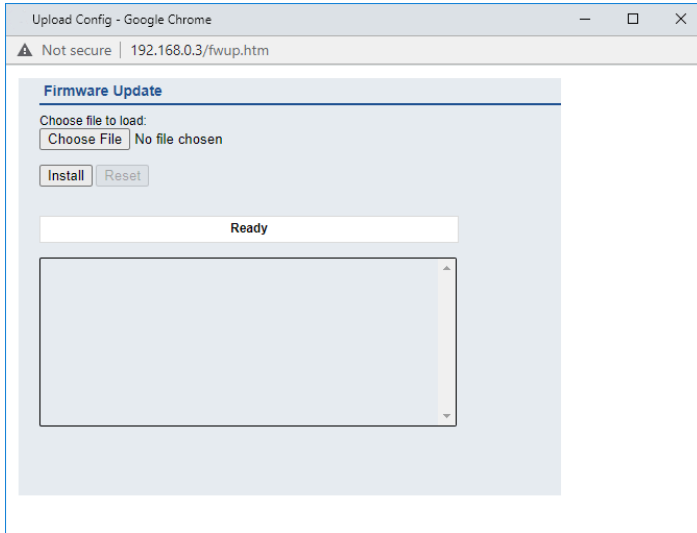

System diagnosis

All Syslog messages will be displayed in a ring buffer with 256 entries. With the 'Store timer', the nonvolatile storing interval can be set.

The default value is 'Off' (no nonvolatile storage of system diagnosis ring buffer).

The configuration is activated by clicking the button *Set configuration*.



15.1.4 The User page

Lion-X Web Interface

Status Ports System **User** Contact

Users

Username	Groups	Edit	Del
admin	Admin, REST, WEB, OPC-UA, FWupdate, IIOTconfig		

Add new user

Please change admin password

The User page provides the user management of the Web interface. New users with access rights "Admin" or "Write" can be added here. For security reasons please change the default admin password immediately after configuring the device.

Default user login data:

- ▶ User: admin
- ▶ Password: private

16 Technical data

The following sections give an overview of the most important functional data needed to operate the device. For further information and detailed technical data, see the respective **Data Sheet** of your required product in the product specific download area on <https://catalog.belden.com>.

16.1 General

Protection class (Only applies if the connectors are screwed together or if protective caps are used.) ¹	IP65 IP67 IP69K	
Ambient temperature (during operation and storage)	0980 XLC 3900... 0980 XLC 3901... 0980 XLC 3903... 0980 XLC 3923...	-40 °C .. +70 °C (-40 °F .. +158 °F)
Weight	LioN-X 60 mm	approx. 500 gr. (17.6 oz)
Ambient moisture	Max. 98% RH (For UL applications: Max. 80% RH)	
Housing material	Die-cast zinc	
Surface finish	Frosted nickel	
Flammability class	UL 94 (IEC 61010)	
Vibration resistance (oscillation) DIN EN 60068-2-6 (2008-11)	15 g/5–500 Hz	
Shock resistance DIN EN 60068-2-27 (2010-02)	50 g/11 ms +/- X, Y, Z	
Fastening torques	M4 fixing screws	1 Nm
	M4 ground connection	1 Nm
	M12 connector	0.5 Nm
Permitted cables	Ethernet cables according to IEEE 802.3, min. CAT 5 (shielded) Max. length of 100 m, not routed out of facility (= local network)	

Table 39: General information

¹ Not under UL investigation.

16.2 EtherNet/IP protocol

Protocol	EtherNet/IP, CIP V3.34
Update cycle	1 ms
EDS file	EDS-V3.36.1-BeldenDeutschland-XXX-yyyymmdd.eds
Transmission rate	10/100 Mbit/s, half/full duplex
Transmission procedure Autonegotiation	10BASE-T/100BASE-TX supported
RPI min.	1 ms
Vendor ID	21
Product type	12 (Communications Adapter)
Product code	40004 (0980 XLC 3900-121-007D-01F, 935715001) 40005 (0980 XLC 3901-121-007D-01F, 935716001) 40006 (0980 XLC 3903-121-007D-01F, 935717001) 40007 (0980 XLC 3923-121-007D-01F, 935718001)
Supported Ethernet protocols	Ping ARP HTTP TCP/IP DHCP/BOOTP
Switch functionality	Integrated
EtherNet/IP interface	2 M12 sockets, 4-pin, D-coded (see Port assignments on page 32)
Connections	2 M12 Hybrid male/female, 8-pin
Autocrossing	supported
Electrically isolated Ethernet ports -> FE	2000 V DC

Table 40: EtherNet/IP protocol

16.3 Power supply of the module electronics/ sensors

Port X03, X04	M12-L-coded Power, connector/socket, 5-pole Pin 1 / Pin 3		
Nominal voltage U_S	24 V DC (SELV/PELV)		
Current U_S	Max. 16 A		
Voltage range	21 .. 30 V DC		
Power consumption of module electronics	Typically 160 mA (+/-20 % at U_S nominal voltage)		
Power supply interruption	Max. 10 ms		
Voltage ripple U_S	Max. 5 %		
Current consumption sensor system (Pin 1)	0980 XLC 3900...	Port X1 .. X8 (Pin 1)	max. 2 A in total for X1 .. X8 (at $T_{\text{ambient}} = 30^\circ \text{C}$)
Current consumption sensor system (Pin 1)	0980 XLC 3901...	Port X1 .. X8 (Pin 1)	max. 2 A in total for X1 .. X8 (at $T_{\text{ambient}} = 30^\circ \text{C}$)
Current consumption sensor system (Pin 1)	0980 XLC 3903...	Port X1 .. X4 (Pin 1)	max. 2 A in total for X1 .. X4 (at $T_{\text{ambient}} = 30^\circ \text{C}$)
Current consumption sensor system (Pin 1)	0980 XLC 3923...	Port X1 .. X4 (Pin 1)	max. 0.2 A per port (at $T_{\text{ambient}} = 30^\circ \text{C}$)
Voltage level of the sensor power supply	Min. ($U_S - 1.5 \text{ V}$)		
Short circuit/overload protection of sensor supply	Yes, per port		
Reverse polarity protection	Yes		

Operational indicator (U_S)	LED green:	$18\text{ V (+/- 1 V)} < U_S$
	LED red:	$U_S < 18\text{ V (+/- 1 V)}$

Table 41: Information on the power supply of the module electronics/sensors

16.4 Power supply of the actuators

Port X03, X04	M12_L-coded Power, connector/socket, 5-pole Pin 2 / Pin 4
Nominal voltage U_L	24 V DC (SELV/PELV)
Voltage range	18 .. 30 V DC
Current U_L	Max. 16 A
Voltage ripple U_L	Max. 5 %
Reverse polarity protection	Yes
Operational indicator (U_L)	LED green: $18 \text{ V (+/- 1 V)} < U_L$ LED red: $U_L < 18 \text{ V (+/- 1 V)}$ or $U_L > 30 \text{ V (+/- 1 V)}$ * if "Report U_L supply voltage fault" is enabled.

Table 42: Information on the power supply of the actuators

16.5 I/O ports

0980 XLC 3900...	Ports X1 .. X8	DI, DO	M12 socket, 5-pin
0980 XLC 3901...	Ports X1 .. X8	DI	M12 socket, 5-pin
0980 XLC 3903...	Ports X1 .. X4	DI	M12 socket, 5-pin
0980 XLC 3923...	Ports X5 .. X8	DO	

Table 43: I/O ports: Overview of functions

16.5.1 Digital inputs

Input connection	0980 XLC 3900...		Type 1 as per IEC 61131-2
Input connection	0980 XLC 3901...		Type 1 as per IEC 61131-2
Input connection	0980 XLC 3903...		Type 1 as per IEC 61131-2
Input connection	0980 XLC 3923...		Type 3 as per IEC 61131-2
Nominal input voltage	24 V DC		
Input current	Typically 3 mA		
Channel type	Normally open, p-switching		
Number of digital inputs	0980 XLC 3900... 0980 XLC 3901...	X1 .. X8	16
Number of digital inputs	0980 XLC 3903... 0980 XLC 3923...	X1 .. X4	8
Status indicator	yellow LED for Channel A (Pin 4) white LED for Channel B (Pin 2)		

Table 44: I/O ports configured as digital input

16.5.2 Digital outputs



Attention: Do not exceed the following maximum currents for the actuator supply:

- ▶ Max. 2.0 A per port
- ▶ Max. 5.0 A for each port pair X1/X2, X3/X4, X5/X6, X7/X8
- ▶ Max. 9.0 A in total for the whole port group X1 .. X8 (X5 .. X8 at 8DI8DO devices)

Pay attention to the derating!

Derating

Depending on the temperature, the module can be loaded with the following maximum total output current of the outputs:

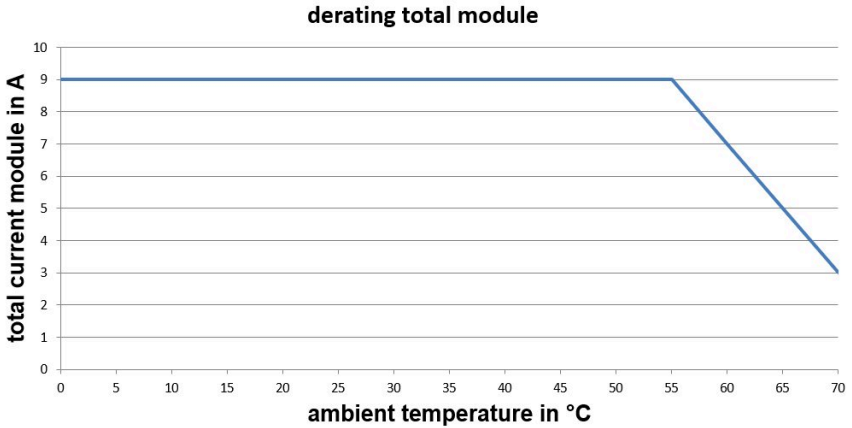

For applications with ambient temperatures higher than +55° C (131° F), a power supply cable (M12-L) with 2.5 mm² must be used.

Output type	normally open, p-switching	
Nominal output voltage per channel	Signal status "1" Signal status "0"	min. ($U_L - 1$ V) max. 2 V
Max. output current per device	0980 XLC 3900... 0980 XLC 3903... 0980 XLC 3923...	9 A
Max. output current per channel	0980 XLC 3900... (X1 .. X8) 0980 XLC 3903... (X5 .. X8) 0980 XLC 3923... (X5 .. X8)	2 A
Short-circuit/overload protected	yes/yes	
Behavior in case of short circuit or overload	deactivation with automatic power-on (parameterized)	
Number of digital outputs	0980 XLC 3900... (X1 .. X8)	16
Number of digital outputs	0980 XLC 3901...	0
Number of digital outputs	0980 XLC 3903... (X5 .. X8) 0980 XLC 3923... (X5 .. X8)	8
Status indicator	yellow LED per output Channel A (Pin 4) white LED per output Channel B (Pin 2)	

Table 45: I/O ports configured as digital output



Warning: If devices with electric isolation and devices without electric isolation are used within the same system, the electric isolation of all connected devices is annulled.

16.6 LEDs

LED	Color	Description
U _L	Green	Auxiliary sensor/actuator voltage OK $18\text{ V (+/- 1 V)} < U_L < 30\text{ V (+/- 1 V)}$
	Red*	Auxiliary sensor/actuator voltage LOW $U_L < 18\text{ V (+/- 1 V)}$ or $U_L > 30\text{ V (+/- 1 V)}$ * if "Report U _L supply voltage fault" is enabled.
	OFF	None of the above conditions.
U _S	Green	System/sensor voltage OK $18\text{ V (+/- 1 V)} < U_S < 30\text{ V (+/- 1 V)}$
	Red	System/sensor voltage LOW $U_S < 18\text{ V (+/- 1 V)}$ or $U_S > 30\text{ V (+/- 1 V)}$
	Red flashing	Device performs a factory reset (position of rotary encoding switches: 9-7-9)
OFF	None of the above conditions.	
X1 ... X8 A	Yellow	Status of digital input or digital output on pin 4 line "on".
	Yellow flashing	Short circuit on pin 4 line. / Overload or short circuit on L+ (pin 1) line / communication error
	OFF	None of the above conditions.
X1 ... X8 B	White	Status of digital input or digital output on pin 2 line "on".
	White flashing	Short circuit on pin 2 line. / Overload or short circuit on L+ (pin 1) line / communication error
	OFF	None of the above conditions.
P1 Lnk/Act P2 Lnk/Act	Green	Ethernet connection to another subscriber exists. Link detected.
	Yellow flashing	Data exchange with another subscriber.
	OFF	No connection to another subscriber. No link, no data exchange.

LED	Color	Description
MS	Green	Device is ready for operation.
	Green flashing	Device is ready but not configured yet.
	Red	Serious error that cannot be resolved.
	Red flashing	Minor error that can be resolved Example: An incorrect or contradictory configuration is classified as a minor error.
	Flashing alternately:	The device is performing a self-test.
	Red Green	
	OFF	The device is switched off.
NS	Green	Connected: The device has at least one connection.
	Green flashing	No connection: The device has no connection. IP address exists.
	Red	Duplicate IP address: The device has detected that the assigned IP address is already being used by another device.
	Red flashing	Connection has exceeded time limit or connection interrupted.
	Flashing alternately:	The device is performing a self-test.
	Red Green	
	OFF	The device is switched off or has not been assigned an IP address.
IO	Red	Detected I/O error (output short circuit or Pin1 short circuit)
	OFF	No detected I/O error

Table 46: Information on the LED colors

16.7 Data transfer times

The following tables give an overview of the internal data transfer times of LioN-X.

There are three measured data direction values for each use case:

- ▶ **PLC to DO:** Transfer of a changed PLC output data to the digital output channel.
- ▶ **DI to PLC:** Transfer of a changed digital input signal on digital input channel to PLC.
- ▶ **Round-trip time (RTT):** Transfer of a changed PLC output data to digital output. The digital output is connected to a digital input. Transfer of the changed digital input signal on the channel to PLC. $RTT = [PLC\ to\ DO] + [DI\ to\ PLC]$.

The measured values are taken from the ethernet data transmission line. The values are therefore without PLC processing times and PLC cycle time.

For calculation of user specific data transfer and round-trip times of possible input filters, PLC processing and cycles times must be taken into calculation.

IOT disabled

Data direction	Data transfer time in ms		
	Minimum	Average	Maximum
PLC to DO	2.3	3.8	5.6
DI to PLC	5.9	6.8	7.8
RTT	8.5	10.7	12.0

IOT enabled

Data direction	Data transfer time in ms		
	Minimum	Average	Maximum
PLC to DO	2.5	3.8	5.5
DI to PLC	5.9	7.0	7.8
RTT	8.5	10.8	12.0

17 Recycling note



The symbol of a crossed-out wheeled bin shown on the device indicates that the device **MUST NOT** be disposed of with household waste at the end of its service life.

After its service life, the used device must be disposed of properly as electronic waste in accordance with the locally applicable disposal regulations.

End users are responsible for deleting personal data from the used device prior to disposal.

End users are obliged to separate used batteries and accumulators that are not enclosed by the used device from the used device in a nondestructive manner before disposing of the used device. The used batteries and accumulators must be handed in for separate collection. This does not apply if the used device is handed in for reuse.

18 Accessories

In order to get access to various types of accessories, please visit our Web page:

<https://www.belden.com>