



**HIRSCHMANN**

A **BELDEN** BRAND

# User Manual

## Installation Industrial Ethernet Firewall EAGLE40-4F

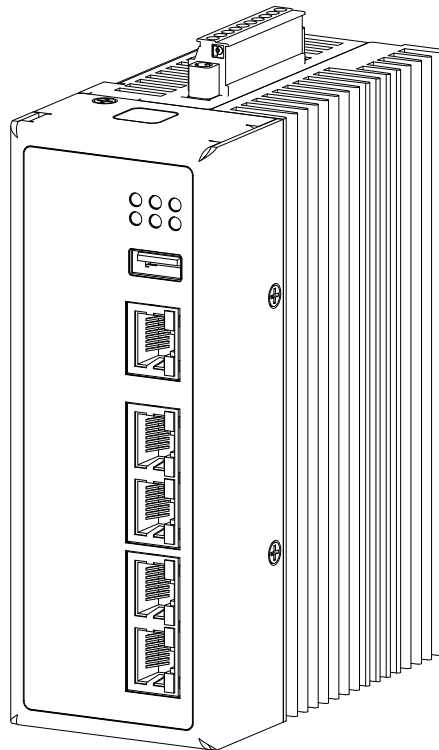

The naming of copyrighted trademarks in this manual, even when not specially indicated, should not be taken to mean that these names may be considered as free in the sense of the trademark and tradename protection law and hence that they may be freely used by anyone.

© 2024 Hirschmann Automation and Control GmbH

Manuals and software are protected by copyright. All rights reserved. The copying, reproduction, translation, conversion into any electronic medium or machine scannable form is not permitted, either in whole or in part. An exception is the preparation of a backup copy of the software for your own use.

The performance features described here are binding only if they have been expressly agreed when the contract was made. This document was produced by Hirschmann Automation and Control GmbH according to the best of the company's knowledge. Hirschmann reserves the right to change the contents of this document without prior notice. Hirschmann can give no guarantee in respect of the correctness or accuracy of the information in this document.

Hirschmann can accept no responsibility for damages, resulting from the use of the network components or the associated operating software. In addition, we refer to the conditions of use specified in the license contract.

You can get the latest version of this manual on the Internet at:  
<https://www.doc.hirschmann.com>

Hirschmann Automation and Control GmbH  
Stuttgarter Str. 45-51  
72654 Neckartenzlingen  
Germany

# Contents

<b>Important information</b>	<b>5</b>
<b>Safety instructions</b>	<b>7</b>
<b>About this manual</b>	<b>15</b>
<b>Key</b>	<b>16</b>
<b>1 Description</b>	<b>17</b>
1.1 General device description	17
1.2 Device name and product code	19
1.3 Device views	20
1.3.1 Front view	20
1.3.2 Top view	21
1.3.3 Bottom view	21
1.4 Power supply	22
1.5 Ethernet ports	22
1.5.1 10/100/1000 Mbit/s twisted pair port	22
1.5.2 Pin assignments	23
1.6 Display elements	23
1.6.1 Device status	23
1.6.2 Ethernet ports	24
1.6.3 Serial port (RS-232/RS-422/RS-485)	25
1.7 Management interfaces	25
1.7.1 Serial port (RS-232/RS-422/RS-485)	25
1.7.2 USB interface	26
1.7.3 microSD card interface	27
1.8 Reset button	28
<b>2 Installation</b>	<b>29</b>
2.1 Checking the package contents	29
2.2 Inserting the microSD card	30
2.3 Installing the device onto the DIN rail	30
2.4 Grounding the device	31

2.5	Wiring the power supply	32
2.6	Operating the device	33
2.7	Connecting data cables	33
2.7.1	Twisted Pair ports	33
2.8	Filling out the inscription label	34
<b>3</b>	<b>Making basic settings</b>	<b>35</b>
3.1	First Login (Password)	35
<b>4</b>	<b>Monitoring the ambient air temperature</b>	<b>37</b>
<b>5</b>	<b>Maintenance and service</b>	<b>38</b>
<b>6</b>	<b>Disassembly</b>	<b>39</b>
6.1	Removing the device	39
<b>7</b>	<b>Technical data</b>	<b>40</b>
7.1	General technical data	40
7.2	Power consumption/power output	40
7.3	Dimension drawings	41
7.4	Electromagnetic compatibility (EMC)	42
7.5	Network range	43
<b>8</b>	<b>Order numbers</b>	<b>44</b>
<b>9</b>	<b>Scope of delivery</b>	<b>45</b>
<b>10</b>	<b>Accessories</b>	<b>46</b>
<b>11</b>	<b>Underlying technical standards</b>	<b>47</b>
<b>A</b>	<b>Further support</b>	<b>48</b>

# Important information

**Note:** Read these instructions carefully, and familiarize yourself with the device before trying to install, operate, or maintain it. The following notes may appear throughout this documentation or on the device. These notes warn of potential hazards or call attention to information that clarifies or simplifies a procedure.

## ■ Symbol explanation



This is a general warning symbol. This symbol alerts you to potential personal injury hazards. Observe all safety notes that follow this symbol to avoid possible injury or death.



If this symbol is displayed in addition to a safety instruction of the type “Danger” or “Warning”, it means that there is a danger of electric shock and failure to observe the instructions will inevitably result in injury.



This symbol indicates the danger of hot surfaces on the device. In connection with safety instructions, non-observance of the instructions will inevitably result in injuries.



## **DANGER**

**DANGER** draws attention to an immediately dangerous situation, which will **inevitably** result in a serious or fatal accident if not observed.



## **WARNING**

**WARNING** indicates a potentially hazardous situation which, if not avoided, **could** result in death or serious injury.



## **CAUTION**

**CAUTION** indicates a possible danger which, if not avoided, **may** result in minor injuries.

# NOTICE

**NOTICE** provides information about procedures that do not involve the risk of injury.

# Safety instructions

## **WARNING**

### **UNCONTROLLED MACHINE ACTIONS**

To avoid uncontrolled machine actions caused by data loss, configure all the data transmission devices individually.

Before you start any machine which is controlled via data transmission, be sure to complete the configuration of all data transmission devices.

**Failure to follow these instructions can result in death, serious injury, or equipment damage.**

### ■ **General safety instructions**

You operate this device with electricity. Improper usage of the device entails the risk of physical injury or significant property damage. The proper and safe operation of this device depends on proper handling during transportation, proper storage and installation, and careful operation and maintenance procedures.

- Before connecting any cable, read this document, and the safety instructions and warnings.
- Operate the device with undamaged components exclusively.
- The device is free of any service components. In case of a damaged or malfunctioning the device, turn off the supply voltage and return the device to Hirschmann for inspection.

### ■ **Certified usage**

- Use the product only for the application cases described in the Hirschmann product information, including this manual.
- Operate the product only according to the technical specifications. [See "Technical data" on page 40.](#)
- Connect to the product only components suitable for the requirements of the specific application case.

### ■ **Installation site requirements**

- Use the device only indoors.
- Install the device inside a suitable enclosure providing safety and environmental protection as required. The enclosure shall be made from metal or other material with a flammability rating of V-0 or better, in accordance with the requirements of the IEC 60950-1 standard for a fire enclosure. An enclosure is not required to prevent a fire hazard if the gateway is installed above concrete or another non-combustible surface.

- Install this device upright with the cooling slots positioned at the top and bottom of the module. The connected cables should not be bent, constricted, in close proximity to high amperage, or exposed to extreme temperatures.
- Verify that there is at least 5 cm (2 in) of space above and below the device.
- Verify that there is at least 1 cm (0.4 in) of space on each side of the device.
- The LEDs on the front panel should be visible for ease of operational verification.
- Ensure that there is adequate airflow around the device, but kept free from direct exposure to the elements, such as sun, rain, dust, etc.

## ■ **Strain relief**

**Note:** If the strain relief is insufficient, there is a potential risk of torsion, contact problems and creeping interruptions.

- Relieve the connection points of cables and lines from mechanical stress.
- Design strain reliefs in such a way that they help prevent any mechanical damage to cables, wires or conductors caused by external influences or their own weight.
- To help prevent damage to device connections, connectors and cables, follow the instructions for proper installation in accordance with DIN VDE 0100-520:2013-06, sections 522.6, 522.7 and 522.13.

## ■ **Device casing**

Only technicians authorized by the manufacturer are permitted to open the casing.

- Never insert pointed objects (narrow screwdrivers, wires, etc.) into the device or into the connection terminals for electric conductors. Do not touch the connection terminals.
- Keep the ventilation slits free to ensure good air circulation.
- Install the device in the vertical position.

## ■ **Qualification requirements for personnel**

- Only allow qualified personnel to work on the device.

Qualified personnel have the following characteristics:

- ▶ Qualified personnel are properly trained. Training as well as practical knowledge and experience make up their qualifications. This is the prerequisite for grounding and labeling circuits, devices, and systems in accordance with current standards in safety technology.
- ▶ Qualified personnel are aware of the dangers that exist in their work.



- ▶ Qualified personnel are familiar with appropriate measures against these hazards in order to reduce the risk for themselves and others.
- ▶ Qualified personnel receive training on a regular basis.

### ■ **National and international safety regulations**

- Verify that the electrical installation meets local or nationally applicable safety regulations.

### ■ **Grounding the device**

Grounding the device is via the 10-pin terminal block for power supply.

- Ground the device before connecting any other cables.
- Disconnect the grounding only after disconnecting all other cables.

### ■ **Shielding ground**

The overall shield of a connected shielded twisted pair cable is connected to the ground connector on the front panel as a conductor.

- Beware of possible short circuits when connecting a cable section with conductive shielding braiding.

### ■ **Requirements for connecting electrical wires**

- Before connecting the electrical wires, **always** verify that the requirements listed are complied with.

---

**All** of the following requirements are complied with:

- ▶ The electrical wires are voltage-free.
- ▶ The cables used are permitted for the temperature range of the application case.
- ▶ The voltage connected complies with the requirements for a safety extra-low voltage (SELV) according to IEC 60950-1 or ES1 according to IEC/EN 62368-1.

---

*Table 1: General requirements for connecting electrical wires*

---

**All** of the following requirements are complied with:

- ▶ The voltage connected complies with the requirements for a safety extra-low voltage (SELV) according to IEC 60950-1 or ES1 according to IEC/EN 62368-1.
- ▶ The connected voltage is limited by a current limitation device or a fuse. Observe the electrical threshold values for the signal contact.  
[See "Technical data" on page 40.](#)
- ▶ The cross-section of the ground conductor is the same size as or bigger than the cross-section of the power supply cables.

---

*Table 2: Requirements for connecting the signal contact*

Device variant	Requirements
All variants	<p><b>All</b> of the following requirements are complied with:</p> <ul style="list-style-type: none"> <li>▶ The supply voltage corresponds to the voltage specified on the type plate of the device.</li> <li>▶ The power supply complies with the requirements as per NEC Class 2.</li> <li>▶ The power supply conforms to overvoltage category I or II.</li> <li>▶ The power supply has an easily accessible disconnecting device (for example, a switch or a plug). This disconnecting device is clearly identified. So in the case of an emergency, it is clear which disconnecting device belongs to which power supply cable.</li> <li>▶ The cross-section of the ground conductor is the same size as or bigger than the cross-section of the power supply cables.</li> <li>▶ Relevant for North America: The power cords are suitable for ambient air temperatures of at least +100 °C (+212 °F). The power cord wires are made of copper.</li> </ul>

Table 3: Requirements for connecting the supply voltage

### ■ Relevant for use in explosion hazard areas (Hazardous Locations, Class I, Division 2)

This equipment is suitable for use in Class I, Division 2, Groups A, B, C, D – OR non-hazardous locations, if labeled “FOR USE IN HAZARDOUS LOCATIONS”.

Cet équipement convient à une utilisation dans la classe I, division 2, groupes A, B, C, D - OU dans des lieux non dangereux, s'il est étiqueté "POUR UTILISATION DANS DES LIEUX DANGEREUX".

Use the device only indoors.

Utilisez l'appareil uniquement à l'intérieur.

This device is an open-type device that is to be installed in an enclosure suitable for the environment such that the device is only accessible with the use of a tool.

Cet équipement est un dispositif de type ouvert qui doit être installé dans une enveloppe adaptée à l'environnement afin que le dispositif soit accessible uniquement avec l'utilisation d'un outil.

Ta: -40 °F ... +158 °F (-40 °C ... +70 °C), temperature code: T4

**WARNING – EXPLOSION HAZARD – DO NOT DISCONNECT EQUIPMENT UNLESS POWER HAS BEEN REMOVED OR THE AREA IS KNOWN TO BE NON-HAZARDOUS.**

**Avertissement** - Risque d'explosion - Ne pas débrancher tant que le circuit est sous tension à moins que l'emplacement soit connu pour ne contenir aucune concentration de gaz inflammable.

WARNING – EXPLOSION HAZARD – SUBSTITUTION OF ANY COMPONENTS MAY IMPAIR SUITABILITY FOR CLASS I, DIVISION 2.

**Avertissement** - Risque d'explosion - La substitution de tout composant peut rendre ce matériel incompatible pour une utilisation en classe I, division 2.

WARNING – WIRING FOR TERMINAL BLOCK SHALL BE MINIMUM 100 °C.

**Avertissement** - Le câblage pour le bloc de bornes doit être au minimum 100 °C.

WARNING – IF THE EQUIPMENT IS USED IN A MANNER NOT SPECIFIED IN BY THE MANUFACTURER, THE PROTECTION PROVIDED BY THE EQUIPMENT MAY BE IMPAIRED.

**Avertissement** - Si l'équipement est utilisé d'une manière non spécifiée par le fabricant, la protection offerte par l'équipement peut être affectée.

#### ■ **ATEX directive 2014/34/EU – specific regulations for safe operation**

In Ex zone 2, only EAGLE40-4F devices with a corresponding label may be operated. When operating the EAGLE40-4F devices in Ex zone 2, the following applies:



II 3 G

Ex ec IIC T4 X Gc

Ta: -40 °F ... +158 °F (-40 °C ... +70 °C)

Temperature code: T4

DO NOT OPEN THE DEVICE WHEN IT IS ELECTRICALLY CHARGED.

THE USB CONNECTOR MUST NOT BE USED WHEN THE DEVICE IS OPERATED IN EXPLOSIVE HAZARDOUS LOCATIONS.

 **Special conditions for safe use**

- ❑ Install the device according to EN 60664-1 in an environment not exceeding degree of pollution 2.
- ❑ Install the device in a suitable enclosure providing a degree of protection of at least IP54 according to EN 60079-0, taking into account the ambient conditions under which the equipment will be used.

## ■ **CE marking**

The labeled devices comply with the regulations contained in the following European directive(s):

### ▶ **2011/65/EU and 2015/863/EU (RoHS)**

Directive of the European Parliament and of the Council on the restriction of the use of certain hazardous substances in electrical and electronic equipment.

### ▶ **2014/30/EU (EMC)**

Directive of the European Parliament and of the Council on the harmonisation of the laws of the Member States relating to electromagnetic compatibility.

### ▶ **2014/34/EU (ATEX)**

Directive of the European Parliament and the council on the harmonisation of the laws of the Member States relating to equipment and protective systems intended for use in potentially explosive atmospheres.

The ATEX Directive applies exclusively to the device variants labeled with an ATEX certificate number:

See [“ATEX directive 2014/34/EU – specific regulations for safe operation”](#) on page 11.

In accordance with the above-named EU directive(s), the EU conformity declaration will be at the disposal of the relevant authorities at the following address:

Hirschmann Automation and Control GmbH  
Stuttgarter Str. 45-51  
72654 Neckartenzlingen  
Germany

You find the EU conformity declaration as PDF file for downloading on the Internet at: <https://www.doc.hirschmann.com/certificates.html>

The product can be used in the industrial sector.

- ▶ Emitted interference: EN 61326-1
- ▶ Safety: EN 61010-2-201

You find more information on technical standards here:  
[See “Technical data” on page 40.](#)

The assembly guidelines provided in these instructions must be strictly adhered to in order to observe the EMC threshold values.

**Warning!** This is a class A device. This device can cause interference in living areas, and in this case the operator may be required to take appropriate measures.

## ■ **FCC note**

### **Supplier's Declaration of Conformity 47 CFR § 2.1077 Compliance Information**

EAGLE40-4F

#### **U.S. Contact Information**

Belden – St. Louis  
1 N. Brentwood Blvd. 15th Floor  
St. Louis, Missouri 63105, United States  
Phone: 314.854.8000

This device complies with part 15 of the FCC Rules. Operation is subject to the following two conditions: (1) This device may not cause harmful interference, and (2) this device must accept any interference received, including interference that may cause undesired operation.

**Note:** This equipment has been tested and found to comply with the limits for a Class A digital device, pursuant to part 15 of the FCC Rules. These limits are designed to provide reasonable protection against harmful interference when the equipment is operated in a commercial environment. This equipment generates, uses, and can radiate radio frequency energy and, if not installed and used in accordance with the instruction manual, may cause harmful interference to radio communications. Operation of this equipment in a residential area is likely to cause harmful interference in which case the user will be required to correct the interference at his own expense.

## ■ Recycling note



The symbol of a crossed-out wheeled bin shown on the device indicates that the device **MUST NOT** be disposed of with household waste at the end of its service life.

After its service life, the used device must be disposed of properly as electronic waste in accordance with the locally applicable disposal regulations.

End users are responsible for deleting personal data from the used device prior to disposal.

End users are obliged to separate used batteries and accumulators that are not enclosed by the used device from the used device in a non-destructive manner before disposing of the used device. The used batteries and accumulators must be handed in for separate collection.

This does not apply if the used device is handed in for reuse.

# About this manual

The “Installation” user manual contains a device description, safety instructions, a description of the display, and the other information that you need to install the device.

The manual is available for download on the Internet: [https://  
www.doc.hirschmann.com](https://www.doc.hirschmann.com)

# Key

The symbols used in this manual have the following meanings:

▶	Listing
□	Work step
■	Subheading



# 1 Description

## 1.1 General device description

The device is an Industrial Ethernet firewall designed for secure remote connectivity and Industrial Internet of Things (IIOT) applications.

The device helps to enable secure and reliable device-to-device and device-to-cloud communications. The gateway includes a serial (RS-232/RS-422/RS-485) port and multiple Ethernet ports, allowing for local connectivity to devices like PAC/PLCs, RTUs, DCS systems, smart instruments, electronic billboards, and communication towers.

The device includes a microSD card interface. The microSD card can be used for data logging or to store the gateway's configuration data.

The device can be configured and managed through the Graphical User Interface.

The devices allow you to set up switched and routed industrial Ethernet networks according to IEEE 802.3.

The device is designed for the special requirements of industrial automation. The device meets the relevant industry standards, provides high operational reliability, even under extreme conditions, and also long-term reliability and flexibility.

The device works without a fan.

The device is mounted by latching in place on a DIN rail.

There are convenient options for managing the device. Manage your devices via:

- ▶ Graphical User Interface
- ▶ SSH
- ▶ HiView (software for putting the device into operation)
- ▶ Network management software (for example Industrial HiVision)  
The Network Management Software Industrial HiVision provides you with options for smooth configuration and monitoring. You find further information on the Internet at the Hirschmann product pages:  
<http://www.hirschmann.com/en/QR/INET-Industrial-HiVision>
- ▶ Serial port (RJ45)

The device provides you with a large range of functions, which the manuals for the operating software inform you about. You will find these manuals in the form of PDF files for downloading on the Internet on the Hirschmann product pages (<https://www.doc.hirschmann.com>).

The Hirschmann network components help you ensure continuous communication across all levels of the company.

## 1.2 Device name and product code

The device name corresponds to the product code. The product code is made up of characteristics with defined positions. The characteristic values stand for specific product properties.

Item	Product characteristic	Characteristic value	Description
1 ... 7	Device	EAGLE40	Security Router and Firewall
8	(hyphen)	–	
9 ... 10	Number: Gigabit Ethernet ports	04	4 × 1000 Mbit/s port
11 ... 13	Configuration of the uplink ports	4T1	4 × Twisted pair RJ45
14	Temperature range	T	Extended -40 °C ... +70 °C (-40 °F ... +158 °F)
15 ... 16	Supply voltage	W9	1 × Voltage input Rated voltage range 12 V DC ... 24 V DC
17	Approvals	X	CE, FCC, EN 61010, UL 61010, ANSI/UL 121201, ATEX
18 ... 19	Type	HS	Hirschmann Standard
20	Software Configuration	9	Default
21	Intrusion Detection System (IDS)	D	Default
22 ... 23	Security Modules	NF UN	No additional modules, firewall only Unified Protection Suite (All Enforcers: DNP3 + Modbus + OPC)
24 ... 28	Software Version	XX.X.	Latest Software Version

Table 4: Device name and product code

## 1.3 Device views

### 1.3.1 Front view

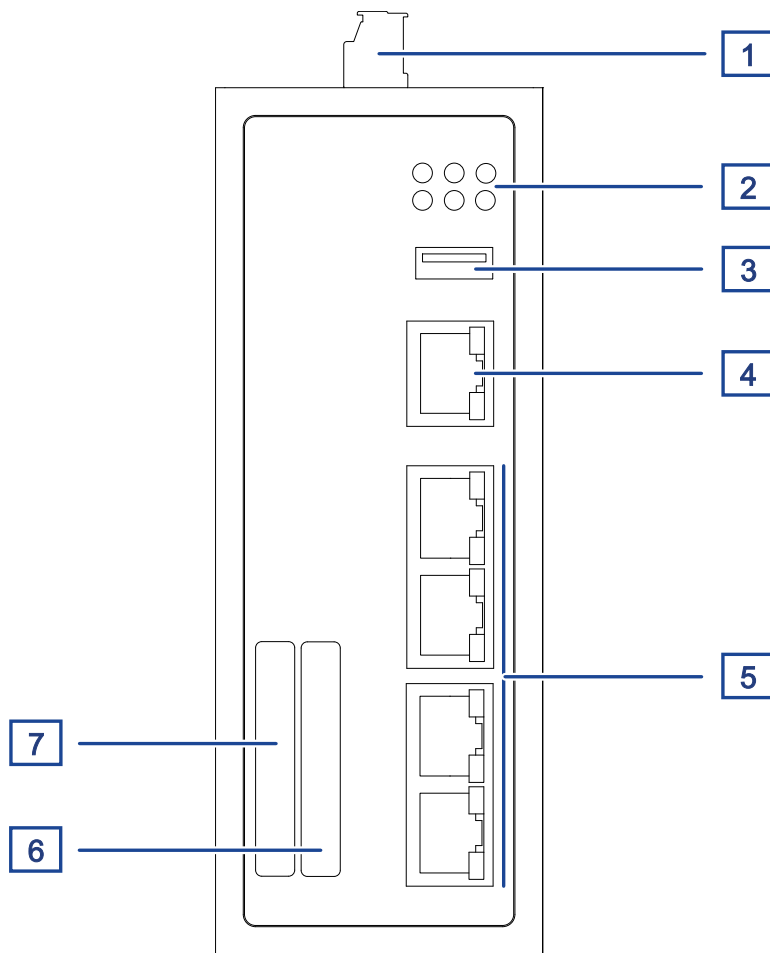

1	10-pin terminal block for power supply
2	LED display element
3	USB interface
4	Serial port (RJ45)
5	4 × Gigabit Ethernet ports (RJ45) for 10/100/1000 Mbit/s Twisted pair connections
6	IP address label
7	MAC address label

### 1.3.2 Top view

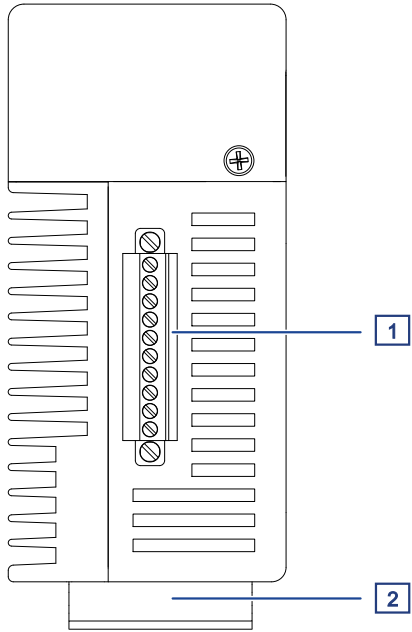

- 
- |   |  |
|---|--|
| 1 | 10-pin terminal block for power supply |
| 2 | DIN rail clip                          |
- 

### 1.3.3 Bottom view

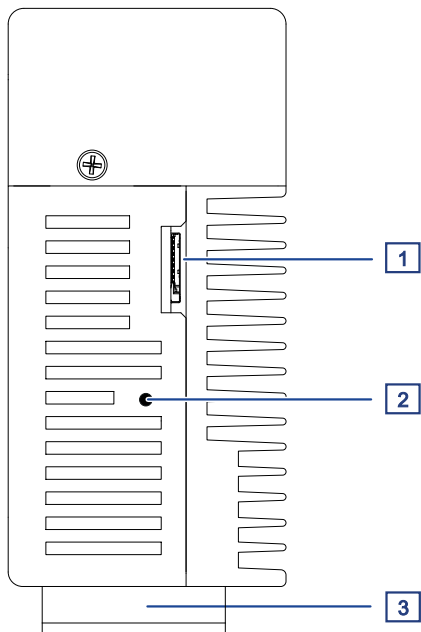

- 
- |   |                           |
|---|---------------------------|
| 1 | microSD card interface    |
| 2 | Reset button <sup>a</sup> |
| 3 | DIN rail clip             |
- 

a. The Reset button has no functionality in the current release.

## 1.4 Power supply

For the power supply of the device, a 10-pin, screwable terminal block is available.

For further information: [See “Wiring the power supply” on page 32.](#)

## 1.5 Ethernet ports

You can connect end devices and other segments to the device ports using twisted pair cables.

[See “Connecting data cables” on page 33.](#)

You find information on pin assignments for making patch cables here:

[See “Pin assignments” on page 23.](#)

### 1.5.1 10/100/1000 Mbit/s twisted pair port

This port is an RJ45 socket.

The 10/100/1000 Mbit/s twisted pair port offers you the ability to connect network components according to the IEEE 802.3 10BASE-T/100BASE-TX/1000BASE-TX standard.

This port supports:

- ▶ Autonegotiation
- ▶ Autopolarity
- ▶ Autocrossing (if autonegotiation is activated)
- ▶ 1000 Mbit/s half-duplex mode, 1000 Mbit/s full duplex mode
- ▶ 100 Mbit/s half-duplex mode, 100 Mbit/s full duplex mode
- ▶ 10 Mbit/s half-duplex mode, 10 Mbit/s full duplex mode

Delivery state: Autonegotiation activated

The socket housing is electrically connected with the front panel.

## 1.5.2 Pin assignments

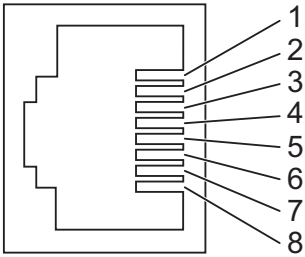
RJ45	Pin	10/100 Mbit/s	1000 Mbit/s
	<b>MDI mode</b>		
	1	TX+	BI_DA+
	2	TX-	BI_DA-
	3	RX+	BI_DB+
	4	—	BI_DC+
	5	—	BI_DC-
	6	RX-	BI_DB-
	7	—	BI_DD+
	8	—	BI_DD-
	<b>MDI-X mode</b>		
	1	RX+	BI_DB+
	2	RX-	BI_DB-
	3	TX+	BI_DA+
	4	—	BI_DD+
	5	—	BI_DD-
	6	TX-	BI_DA-
7	—	BI_DC+	
8	—	BI_DC-	

## 1.6 Display elements

After the supply voltage is set up, the software starts and initializes itself. Afterwards, the device performs a self-test. During this process, various LEDs light up.

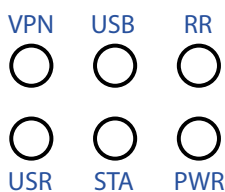

### 1.6.1 Device status

The LEDs described in the following table provide information about conditions which affect the operation of the whole device.

LED	Display	Color	Activity	Meaning
VPN	Virtual Private Network	—	None	At least one of the following cases applies: <ul style="list-style-type: none"> <li>▶ The VPN status display is switched off.</li> <li>▶ No VPN connection is active.</li> <li>▶ No active VPN connection is in the "up" status.</li> </ul>
		Green	Lights up	The VPN status display is switched on, and at least 1 VPN connection is active and in the "up" status.
USB	Storage medium	—	None	No storage medium connected.
		Green	Lights up	Storage medium is plugged.
RR	Router redundancy	—	None	No router redundancy configured.
		Green	Lights up	The device is in the Router Redundancy Master mode.
		Red	Lights up	The device is in the Router Redundancy Backup mode.
USR	Function not available yet	—	None	Reserved for future use.
STA	Device status	Green	Lights up	There is currently no device status alarm. The device status is OK.
		Red	Lights up	There is currently at least one device status alarm.
PWR	Supply voltage	—	None	No power supply.
		Green	Lights up	Power supply is active.

## 1.6.2 Ethernet ports

These LEDs display port-related information. During the boot phase, they indicate the status of the boot process.

The LEDs are directly located on the ports.

Display	Color	Activity	Meaning
Link status	—	none	Device detects an invalid or missing link
	Green	Lights up	100 Mbit/s link is up without data traffic
		Flashes 1 time a period	100 Mbit/s link is up with data traffic
	Yellow	Lights up	1000 Mbit/s link is up without data traffic
		Flashes 1 time a period	1000 Mbit/s link is up with data traffic
	Green AND Yellow	Light up	10 Mbit/s link is up without data traffic
		Flash 1 time a period	10 Mbit/s link is up with data traffic



### 1.6.3 Serial port (RS-232/RS-422/RS-485)

These LEDs display port-related information. During the boot phase, they indicate the status of the boot process.

The LEDs are directly located on the port.

Display	Color	Activity	Meaning
Link status	—	none	No console connection
	Green	Flashes 1 time a period	Device reboots with active console connection
	Green AND Yellow	Flashes 1 time a period	Data write in working console connection

## 1.7 Management interfaces

### 1.7.1 Serial port (RS-232/RS-422/RS-485)

**Note:** On delivery, the serial port is sealed with a premounted protective cap. When not in use, seal the serial port with the protection cap.

The device has 1 serial port (RS-232/RS-422/RS-485) which uses an 8-pin RJ45 connector.

For information about the position on the device: [See “Front view” on page 20.](#)

A DB9 male adapter cable allows for RS-232, RS-422 and RS-485 connections.

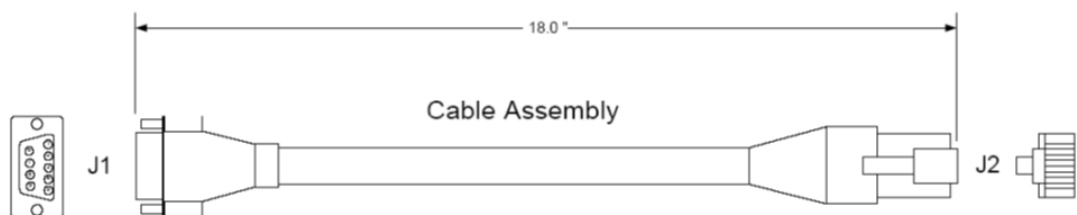

Figure 1: Cable assembly DB9 male adapter cable

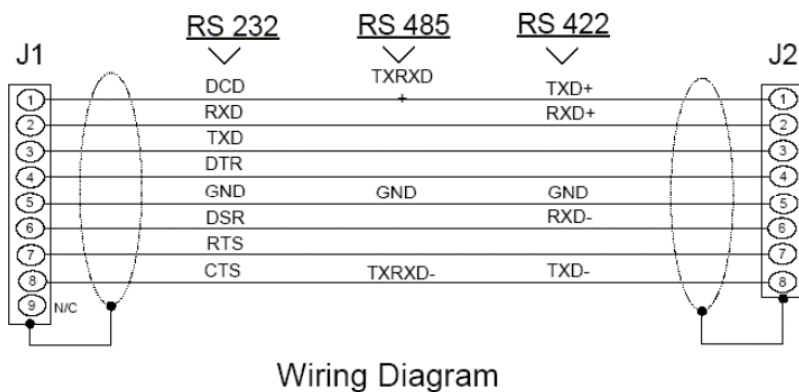

Figure 2: Wiring diagram

### 1.7.2 USB interface

**Note:** For information about the position on the device, see “Front view” on page 20

The USB socket has an interface for the local connection of an AutoConfiguration Adapter ACA22-USB (EEC). It is used for saving/loading the configuration data and diagnostic information, and for loading the software.

The USB interface has the following properties:

- ▶ Supports the USB master mode
- ▶ Supports USB 2.0 (data rate max. 480 MBit/s)
- ▶ Connector type A
- ▶ Supplies current of max. 500 mA
- ▶ Voltage not potential-separated
- ▶ Supported file system: FAT32

Figure	Pin	Operation
	1	VCC (VBus)
	2	- Data
	3	+ Data
	4	Ground (GND)

Table 5: Pin assignment of the USB interface

### 1.7.3 microSD card interface

**Note:** For information about the position on the device, see [“Bottom view” on page 21](#)

This is an optional accessory. The microSD card interface is located on the bottom of the device. Any industrial microSD card (15 mm × 12 mm × 0.76 mm / 0.59 in × 0.47 in × 0.03 in) up to 32 GB with an extended operating temperature range (-40 °C ... +70 °C / -40 °F ... +158 °F) or better is supported. The extended temperature range is required so it will match the operating temperature range of the device.

The microSD card has the following use cases:

- ▶ File relay – transfer files between segmented networks
- ▶ Data logging – store time stamped data

The microSD card interface allows you to connect the AutoConfiguration Adapter ACA41 storage medium. This is used for saving/loading the configuration data and diagnostic information, and for loading the software. The ACA41 supports the FAT16 file system format exclusively.

## 1.8 Reset button

For information about the position on the device, see “[Bottom view](#)” on [page 21](#)

**Note:** The Reset button has no functionality in the current release.

You will find detailed information for performing a factory reset in the software manual “User Manual Configuration” in the chapter “Reset the device to the factory defaults”.

The manual is available for download on the Internet: <https://www.doc.hirschmann.com>

## 2 Installation

The devices have been developed for practical application in a harsh industrial environment.

On delivery, the device is ready for operation.

Perform the following work steps to install and configure the device:

- ▶ [Checking the package contents](#)
- ▶ [Installing the device onto the DIN rail](#)
- ▶ [Wiring the power supply](#)
- ▶ [Operating the device](#)
- ▶ [Connecting data cables](#)
- ▶ [Filling out the inscription label](#)

### 2.1 Checking the package contents

- Check whether the package includes all items named in the section [“Scope of delivery” on page 45](#).
- Check the individual parts for transport damage.

## 2.2 Inserting the microSD card

The microSD card interface uses a push/push latch mechanism to insert and remove the microSD card.

**Note:** After inserting the microSD card, be careful NOT to eject or damage it when standing up the device.

**Note:** To help prevent data loss, make sure the device is NOT powered when inserting or removing the microSD card.

## 2.3 Installing the device onto the DIN rail

### **WARNING**

#### **FIRE HAZARD**

Install the device inside a suitable enclosure providing safety and environmental protection as required. The enclosure shall be made from metal or other material with a flammability rating of V-0 or better, in accordance with the requirements of the IEC 60950-1 standard for a fire enclosure. An enclosure is not required to prevent a fire hazard if the gateway is installed above concrete or another non-combustible surface.

**Failure to follow these instructions can result in death, serious injury, or equipment damage.**

**Note:** Verify that there is at least 5 cm (2 in) of space above and below the device.

Verify that there is at least 1 cm (0.4 in) of space on each side of the device.

**Note:** The overall shield of a connected shielded twisted pair cable is connected to the ground connector on the front panel as a conductor.

To mount the device onto a horizontally mounted 35 mm DIN rail according to DIN EN 60715, proceed as follows:

- Slide the upper snap-in guide of the device into the DIN rail.
- Press the device downwards onto the clip-in bar.
- Snap in the device.

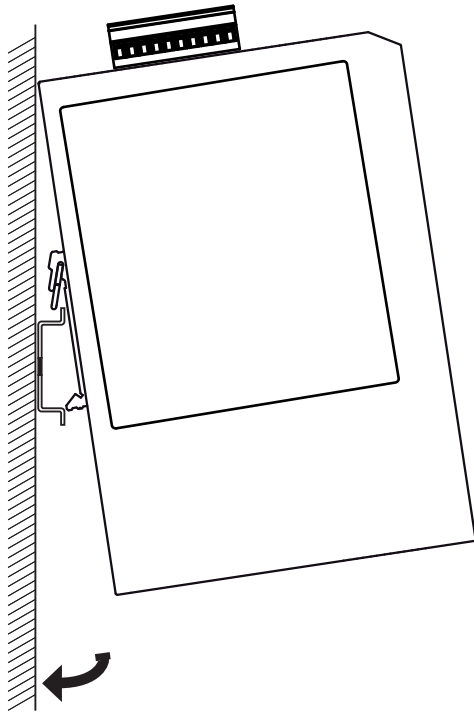

Figure 3: Mounting on the DIN rail

## 2.4 Grounding the device

The device has a functional ground connection. The device is grounded via the 10-pin terminal block that is located at the top of the device.

- Wire the 10-pin terminal block according to the following figure that shows the pin assignments for the functional ground connection:

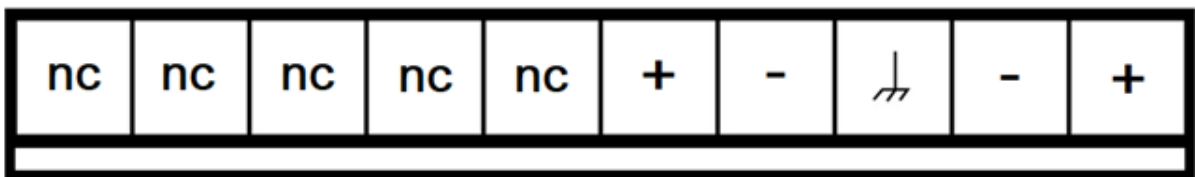

Figure 4: 10-pin terminal block

Pin	Description
nc	not connected
nc	not connected

Table 6: Type and specification of the supply voltage, pin assignment on the device

Pin	Description
nc	not connected
nc	not connected
nc	not connected
+	Power Input 2 (12 V DC ... 24 V DC)
-	Power 2 ground
	Functional ground connection
	
-	Power 1 ground
+	Power Input 1 (12 V DC ... 24 V DC)

Table 6: Type and specification of the supply voltage, pin assignment on the device

## 2.5 Wiring the power supply

The 10-pin terminal block is located at the top of the device is used for the power supply.

**Note:** Power Input 1 or Power Input 2 can be used to supply power to the device. The maximum input current is 3 A.

**Note:** Wiring the terminal block incorrectly can cause serious damage to the device.

- Remove the 10-pin terminal block from the device.
- Connect the wires with the clamps according to the following pin assignment of the 10-pin terminal block:

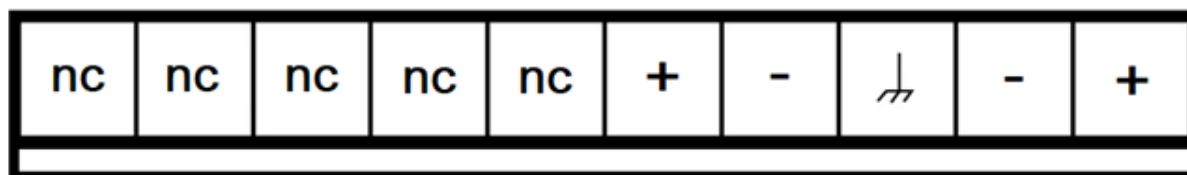



Figure 5: 10-pin terminal block

Pin	Description
nc	not connected
nc	not connected

Table 7: Type and specification of the supply voltage, pin assignment on the device



Pin	Description
nc	not connected
nc	not connected
nc	not connected
+	Power Input 2 (12 V DC ... 24 V DC)
-	Power 2 ground
	Functional ground connection
	
-	Power 1 ground
+	Power Input 1 (12 V DC ... 24 V DC)

*Table 7: Type and specification of the supply voltage, pin assignment on the device*

- Fasten the wires connected by tightening the terminal screws.

## 2.6 Operating the device

The power supply should use a dedicated power source.

The power supply should be separate from the power supplies used to drive motors, pumps, or other noisy equipment. The control and communication equipment should be on a separate power rail.

The torque for tightening the supply voltage terminal block on the device is 0.3 Nm (2.7 lb-in).

- Mount the 10-pin terminal block on the device using screws.
- Enable the supply voltage.

## 2.7 Connecting data cables

### 2.7.1 Twisted Pair ports

Note the following general recommendations for data cable connections in environments with high electrical interference levels:

- Keep the length of the data cables as short as possible.
- Use optical data cables for the data transmission between the buildings.
- When using copper cables, provide a sufficient separation between the power supply cables and the data cables. Ideally, install the cables in separate cable channels.

- Verify that power supply cables and data cables do not run parallel over longer distances. To reduce inductive coupling, verify that the power supply cables and data cables cross at a 90 ° angle.
- Use shielded data cables for gigabit transmission via copper cables, for example SF/UTP cables according to ISO/IEC 11801. To meet EN 50121-4 and marine application requirements, use shielded data cables at all transmission rates.
- Connect the data cables according to your requirements.  
[See “10/100/1000 Mbit/s twisted pair port” on page 22.](#)

## **2.8 Filling out the inscription label**

The information field for the IP address helps you identify your device.

## 3 Making basic settings

**Note:** 2 or more devices configured with the same IP address can cause unpredictable operation of your network.

Install and maintain a process that assigns a unique IP address to every device in the network.

The IP parameters must be entered when the device is installed for the first time. The device provides the following options for configuring IP addresses:

- ▶ Entry via serial port with RJ45 connector
- ▶ Graphical User Interface
- ▶ Entry via the HiDiscovery protocol in the applications HiDiscovery or Industrial HiVision
- ▶ AutoConfiguration Adapter

Further information on the basic settings of the device can be found in the software user manuals.

The software user manuals are available for download on the Internet: <https://www.doc.hirschmann.com>

### ■ Default settings

- ▶ Serial port data rate: 115200 Baud
- ▶ DB9 port data rate: 115200 Baud
- ▶ Ethernet ports: link status is not evaluated (signal contact)
- ▶ TP ports: Autonegotiation

## 3.1 First Login (Password)

To help prevent undesired access to the device, it is imperative that you change the default password during initial setup.

Perform the following work steps:

- Open the Graphical User Interface, the Command Line Interface, or HiView the first time you log on to the device.
- Log on to the device with the default password “private”. The device prompts you to type in a new password.
- Type in your new password.  
To help increase security, choose a password that contains at least 8 characters which includes upper-case characters, lower-case characters, numerical digits, and special characters.
- When you log on to the device with the Command Line Interface, then the device prompts you to confirm your new password.
- Log on to the device again with your new password.

**Note:** If you lost your password, then use the System Monitor to reset the password.

For further information see:

<https://hirschmann-support.belden.com/en/kb/required-password-change-new-procedure-for-first-time-login>

## 4 Monitoring the ambient air temperature

Operate the device below the specified maximum ambient air temperature exclusively.

See [“Technical data” on page 40](#).

The ambient air temperature is the temperature of the air at a distance of 5 cm (2 in) from the device. It depends on the installation conditions of the device, for example the distance from other devices or other objects, and the output of neighboring devices.

The temperature displayed in the CLI and the GUI is the internal temperature of the device. It is up to +20 °C (+68 °F) higher than the ambient temperature. This depends on the configuration of your device.

## 5 Maintenance and service

- When designing this device, Hirschmann largely avoided using high-wear parts. The parts subject to wear and tear are dimensioned to last longer than the lifetime of the product when it is operated normally. Operate this device according to the specifications.
- Relays are subject to natural wear. This wear depends on the frequency of the switching operations. Check the resistance of the closed relay contacts and the switching function depending on the frequency of the switching operations.
- Hirschmann is continually working on improving and developing their software. Check regularly whether there is an updated version of the software that provides you with additional benefits. You find information and software downloads on the Belden product pages on the Internet: <https://www.belden.com>
- Depending on the degree of pollution in the operating environment, check at regular intervals that the ventilation slots in the device are not obstructed.

## 6 Disassembly

### 6.1 Removing the device

- Disconnect the data cables.
- Disable the supply voltage.
- Disconnect the terminal block.
- To remove the device from the DIN rail, press the device downwards and pull it out from under the DIN rail.

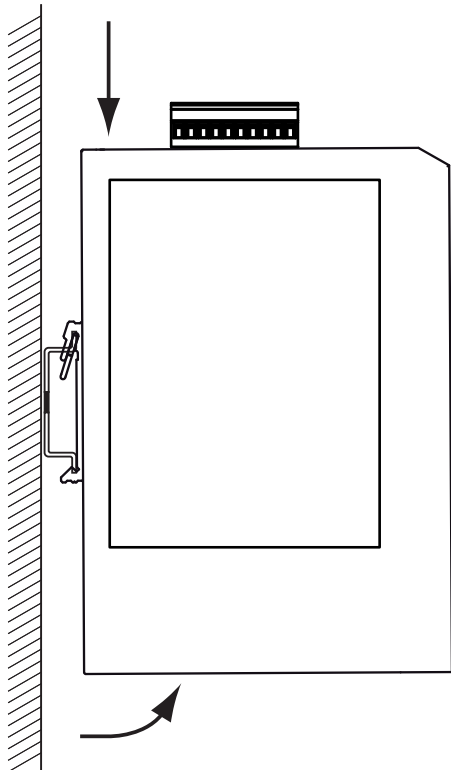

Figure 6: Removal from the DIN rail

# 7 Technical data

## 7.1 General technical data

General technical data		
Dimensions W × H × D	See "Dimension drawings" on page 41.	
Weight	EAGLE40-4F	630 g (22.22 oz)
Supply voltage	Connection type	10-pin terminal block with screw lock for power supply
	Tightening torque	0.3 Nm (2.7 lb-in)
	Nominal voltage range	12 V DC ... 24 V DC
	Voltage range incl. maximum tolerances	9.6 V DC ... 32 V DC
	Overload current protection on the device	Non-replaceable fuse
Back-up fuse	Nominal rating: 3 A	
	Characteristic: slow blow	
Peak inrush current	0.5 A	
Climatic conditions during operation	Minimum clearance around the device	Top and bottom device side: 5 cm (2 in) Left and right device side: 1 cm (0.4 in)
	Ambient air temperature <sup>a</sup>	-40 °C ... +70 °C (-40 °F ... +158 °F)
	Humidity	5 % ... 95 % (non-condensing)
	Air pressure	min. 700 hPa (+3000 m ASL; +9842 ft ASL) max. 1060 hPa (-400 m ASL; -1312 ft ASL)
Climatic conditions during storage	Ambient air temperature <sup>a</sup>	-40 °C ... +80 °C (-40 °F ... +176 °F)
	Humidity	5 % ... 95 % (non-condensing)
	Air pressure	min. 700 hPa (+3000 m ASL; +9842 ft ASL) max. 1060 hPa (-400 m ASL; -1312 ft ASL)
Pollution degree	2	
Degree of protection	IP30	

a. Temperature of the ambient air at a distance of 5 cm (2 in) from the device

## 7.2 Power consumption/power output

Maximum power consumption	Power output
12 W	40.94 Btu (IT)/h



# 7.3 Dimension drawings

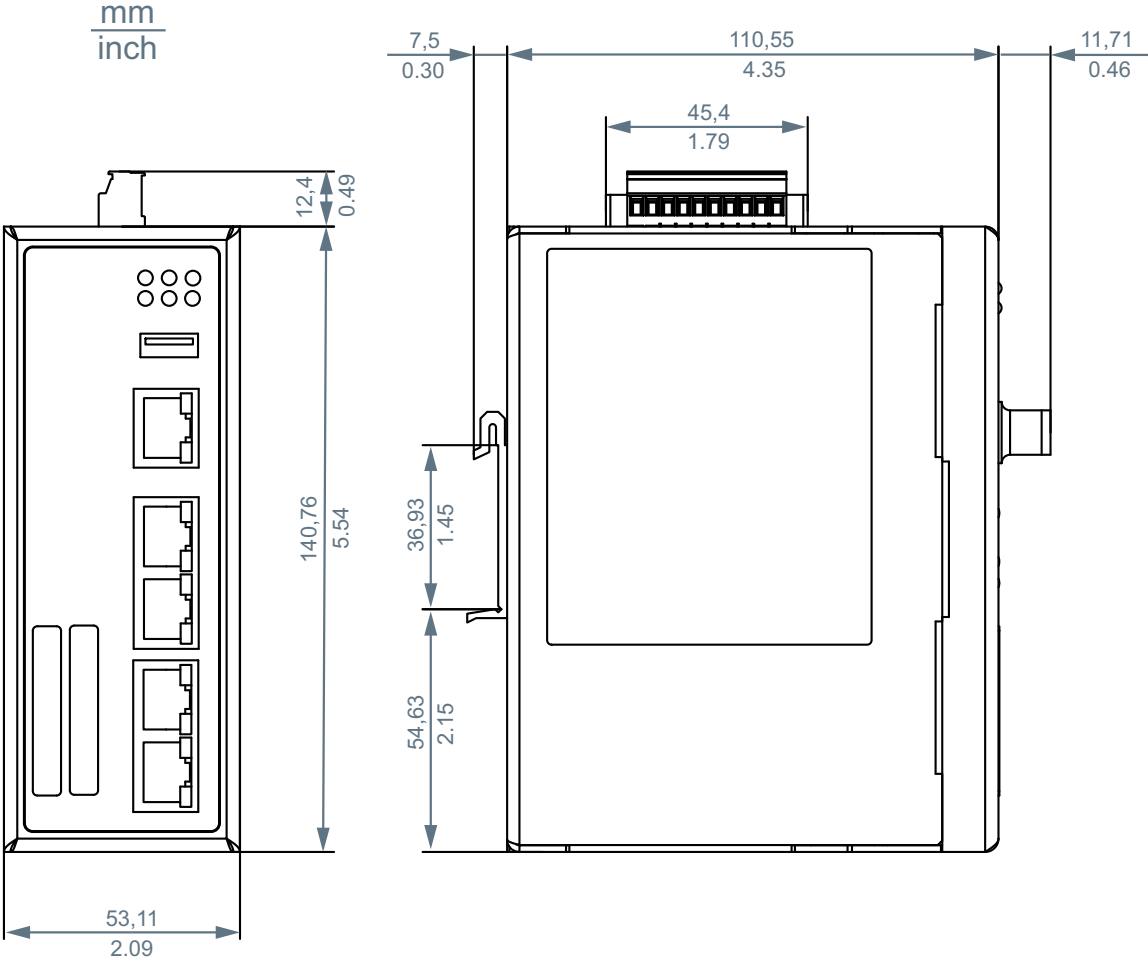

Figure 7: Dimensions of the EAGLE40-4F

## 7.4 Electromagnetic compatibility (EMC)

EMC interference emission		Standard applications
<b>Radiated emission</b>		
EN 61326-1		Class A
FCC 47 CFR Part 15		Class A

EMC interference immunity		Standard applications
<b>Electrostatic discharge</b>		
EN 61000-4-2	Contact discharge	4 kV
EN 61000-4-2	Air discharge	8 kV
<b>Electromagnetic field</b>		
EN 61000-4-3	80 MHz ... 1000 MHz	10 V/m
	1 GHz ... 6 GHz	10 V/m
<b>Fast transients (burst) - power supply connection</b>		
EN 61000-4-4		2 kV
<b>Fast transients (burst) - data line</b>		
EN 61000-4-4		4 kV
<b>Voltage surges - power supply connection</b>		
EN 61000-4-5	line/ground	2 kV
EN 61000-4-5	line/line	1 kV
<b>Voltage surges - data line</b>		
EN 61000-4-5	line/ground	1 kV
<b>Conducted disturbances</b>		
EN 61000-4-6	150 kHz ... 80 MHz	10 V

# 7.5 Network range

10/100/1000 Mbit/s twisted pair port	
Length of a twisted pair segment	max. 100 m (328 ft) (for Cat5e cable)

Table 8: Network range: 10/100/1000 Mbit/s twisted pair port

## 8 Order numbers

Device	Order number
EAGLE40-044T1TW9XHS9ANFXX.X.XX No additional modules, firewall only	942333001
EAGLE40-044T1TW9XHS9AUNXX.X.XX Unified Protection Suite (All Enforcers: DNP3 + Modbus + OPC)	942333002

## 9 Scope of delivery

Number	Article
1 ×	Device
1 ×	Safety and general information sheet
1 ×	Explosion warning sheet
1 ×	Open source information sheet
1 ×	10-pin terminal block for power supply
1 ×	DB9 M to RJ45 adapter cable
1 ×	RJ45 protector cap for serial port premounted

# 10 Accessories

Note that products recommended as accessories may have different characteristics to those of the device, which may limit the application range of the overall system. For example, if you add an accessory with IP20 to a device with IP65, the IP of the overall system is reduced to IP20.

Name	Order number
DB9 M to RJ45 adapter cable	942341001
AutoConfiguration Adapter ACA22-USB (EEC)	942124001
AutoConfiguration Adapter ACA41	942342001
Industrial HiVision Network Management Software	943156xxx

# 11 Underlying technical standards

Designation	
ANSI/UL 121201	Nonincendive electrical equipment for use in class I and II, division 2 and class III, divisions 1 and 2 hazardous (classified) locations
CSA C22.2 No. 213	Canadian National Standard(s) for Nonincendive Electrical Equipment for Use in Class I, Division 2 Hazardous Locations
EN 60079-0	Explosive atmospheres – Part 0: Equipment – General requirements
EN 60079-7	Explosive atmospheres – Part 7: Equipment protection by increased safety
EN 61326-1	Electrical equipment for measurement, control and laboratory use - EMC requirements – Part 1: General requirements
EN 61010-1	Safety requirements for electrical equipment for measurement, control, and laboratory use - Part 1: General requirements
EN 61010-2-201	Safety requirements for electrical equipment for measurement, control, and laboratory use - Part 2-201: Particular requirements for control equipment
FCC 47 CFR Part 15	Code of Federal Regulations
UL 61010-1	Safety requirements for electrical equipment for measurement, control, and laboratory use - Part 1: General requirements
UL 61010-2-201	Safety requirements for electrical equipment for measurement, control, and laboratory use - Part 2-201: Particular requirements for control equipment

*Table 9: List of the technical standards*

The device generally fulfills the technical standards named in their current versions.

The device has an approval based on a specific standard only if the approval indicator appears on the device casing.

If your device has a shipping approval according to Germanischer Lloyd, you find the approval mark printed on the device label. You will find out whether your device has other shipping approvals on the Hirschmann website under [www.hirschmann.com](http://www.hirschmann.com) in the product information.

# A Further support

## Technical questions

For technical questions, please contact any Hirschmann dealer in your area or Hirschmann directly.

You find the addresses of our partners on the Internet at <https://www.belden.com>.

A list of local telephone numbers and email addresses for technical support directly from Hirschmann is available at <https://hirschmann-support.belden.com>.

This site also includes a free of charge knowledge base and a software download section.

## Customer Innovation Center

The Customer Innovation Center is ahead of its competitors on three counts with its complete range of innovative services:

- ▶ Consulting incorporates comprehensive technical advice, from system evaluation through network planning to project planning.
- ▶ Training offers you an introduction to the basics, product briefing and user training with certification.  
You find the training courses on technology and products currently available at <https://www.belden.com/solutions/customer-innovation-center>.
- ▶ Support ranges from the first installation through the standby service to maintenance concepts.

With the Customer Innovation Center, you decide against making any compromises in any case. Our client-customized package leaves you free to choose the service components you want to use.

Internet:

<https://www.belden.com/solutions/customer-innovation-center>





**HIRSCHMANN**

---

A **BELDEN** BRAND