



HIRSCHMANN

A **BELDEN** BRAND

User Manual

Installation

Dragon PTN

Interface Module PTN-1-10G-LW

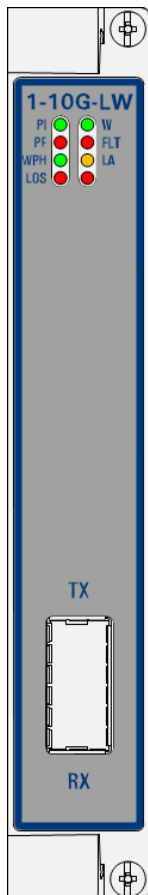

The naming of copyrighted trademarks in this manual, even when not specially indicated, should not be taken to mean that these names may be considered as free in the sense of the trademark and tradename protection law and hence that they may be freely used by anyone.

© 2019 Hirschmann Automation and Control GmbH

Manuals and software are protected by copyright. All rights reserved. The copying, reproduction, translation, conversion into any electronic medium or machine scannable form is not permitted, either in whole or in part. An exception is the preparation of a backup copy of the software for your own use.

The performance features described here are binding only if they have been expressly agreed when the contract was made. This document was produced by Hirschmann Automation and Control GmbH according to the best of the company's knowledge. Hirschmann reserves the right to change the contents of this document without prior notice. Hirschmann can give no guarantee in respect of the correctness or accuracy of the information in this document.

Hirschmann can accept no responsibility for damages, resulting from the use of the network components or the associated operating software. In addition, we refer to the conditions of use specified in the license contract.

You can get the latest version of this manual on the Internet at the Hirschmann product site (www.doc.hirschmann.com).

Hirschmann Automation and Control GmbH
Stuttgarter Str. 45-51
72654 Neckartenzlingen
Germany

Contents

1.	INTRODUCTION	5
1.1	General.....	5
1.2	Manual References	5
2.	MODULE DESCRIPTION	6
2.1	Front Panel	6
2.1.1	Insert/Remove Module into/from Node	6
2.1.2	LEDs.....	6
2.1.3	Connectors.....	8
2.2	Functional Operation	8
2.2.1	Media Module for Ethernet: Interfacing to a LAN or WAN Network.....	8
2.2.2	LAN/WAN PHY Setting.....	9
2.2.3	Ethernet Service	10
2.2.4	Voice Service.....	11
2.2.5	I/O with the Central Switching Module (=CSM)	11
2.2.6	Synchronization / Clock Distribution / Network Timing.....	11
2.2.7	EFM-F IEEE 802.3ah (=Ethernet in the First Mile – Fiber) (Future)	12
2.2.8	MPLS-TP Compliancy	12
2.2.9	Storm Control on Ethernet LAN Port.....	12
2.2.10	BPDU Guard on Ethernet LAN Port.....	12
2.2.11	MRP (=Media Redundancy Protocol) Support	13
2.3	Onboard Interfaces	14
2.3.1	Heat Sink.....	14
2.3.2	Straps	14
2.3.3	Rotary DIP Switches.....	14
3.	MODULE SPECIFICATIONS	15
3.1	General Specifications.....	15
3.2	Other Specifications.....	15
3.3	Ordering Information.....	15
4.	ABBREVIATIONS	15

List of figures

Figure 1	Front Panel	6
Figure 2	XFP Module / Optical XFP Ethernet Port.....	8
Figure 3	General Example: LAN/WAN	9
Figure 4	Detailed Example: PTN-1-10G-LW Interfacing to a LAN/WAN Network.....	9
Figure 5	LAN/WAN PHY Cases	10
Figure 6	MRP: General Example.....	13
Figure 7	PTN-1-10G-LW: Side View	14
Figure 8	Hardware Edition.....	14

List of Tables

Table 1 Manual References	5
Table 2 LED Indications In Boot Operation	7
Table 3 LED Indications in Normal Operation	7
Table 4 Synchronization / Clock Distribution / Network Timing Overview	11
Table 5 Other Specifications	15

1. INTRODUCTION

1.1 General

This document is valid as of Dragon PTN Release 4.0DR.

This document describes the PTN-1-10G-LW interface module which supports 10 Gigabit Ethernet according the IEEE 802.3ae-2002 standard. This standard specifies full duplex point-to-point links. This standard also provides two types of PHY: LAN PHY and WAN PHY. The 10G WAN PHY operates at a data rate compatible with SONET OC-192c.

This module provides one 10 Gbps optical LAN/WAN port on the front panel (LAN = Local Area Network; WAN = Wide Area Network). PTN-1-10G-LW refers to '1 port – 10 Gigabit – LAN WAN'.

This port is configurable as LAN or WAN (=default) via HiProvision (=Dragon PTN Management System).

Verify the 'Dragon PTN Bandwidth Overview' manual (Ref. [100] in Table 1) to see in which node and Interface Module slot this Interface Module can be used.

Main supported features:

- ▶ 1 optical port supporting 10 Gbps Ethernet over fiber via XFPs, full duplex. Which LAN and WAN XFP modules are supported can be found in Ref.[8] in Table 1.
- ▶ LAN/WAN port function;
- ▶ LAN/WAN PHY function;
- ▶ Synchronization
 - ▶ SyncE;
 - ▶ PTP IEEE 1588v2 (=Precision Time Protocol).
- ▶ E-Tree in an Ethernet Service;
- ▶ MRP (=Media Redundancy Protocol) Support.

1.2 Manual References

Table 1 is an overview of the manuals referred to in this manual. All these manuals can be found in the HiProvision (=Dragon PTN Management System) Help function.

Table 1 Manual References

Ref.	Manual	Title
[1]	UM_BasicConfig_Dragon-PTN_and_HiProvision-Operation_Rel_4-0DR_1019_en.pdf	Dragon PTN and HiProvision Operation
[2]	IG_Dragon-PTN_Installation-and-Operation_02_1019_en.pdf	Dragon PTN Installation and Operation
[4]	IG_Dragon-PTN_PTIN-CSM310-A_02_1019_en.pdf	Dragon PTN Switching Module: PTN-CSM310-A
[5]	IG_Dragon-PTN_PTIN-4-GC-LW_PTIN-4-GCB-LW_02_1019_en.pdf	Dragon PTN Interface Module: PTN-4-GC-LW/PTN-4-GCB-LW
[6]	IG_Dragon-PTN_PTIN-4-GO-LW_01_1019_en.pdf	Dragon PTN Interface Module: PTN-4-GO-LW
[7]	IG_Dragon-PTN_PTIN-8-FXS_01_1019_en.pdf	Dragon PTN Interface Module: PTN-8-FXS
[8]	IG_Dragon-PTN_TRMs_SFP_XFP_02_1019_en.pdf	Dragon PTN TRMs (Transmit Receive Modules: SFP, XFP)
[9]	IG_Dragon-PTN_General-Specifications_01_1019_en.pdf	Dragon PTN General Specifications

2. MODULE DESCRIPTION

2.1 Front Panel

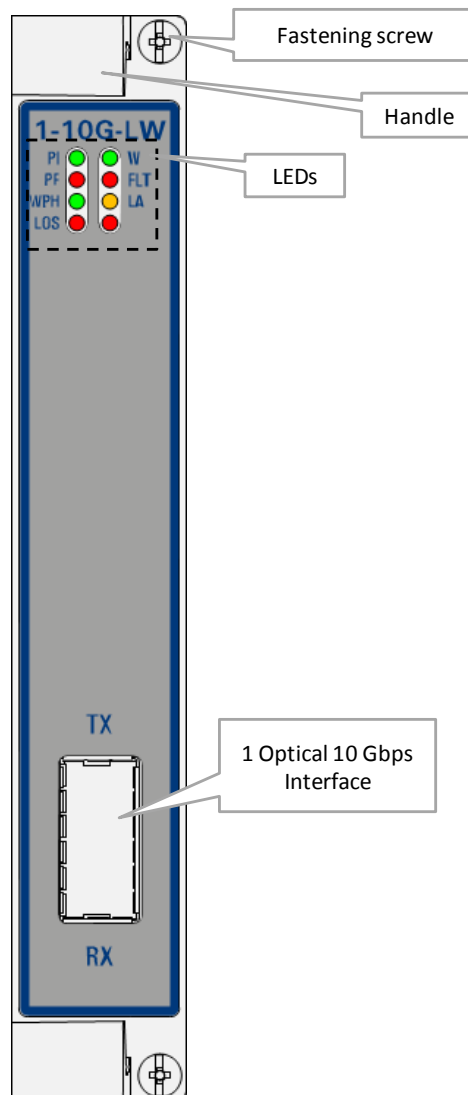

Figure 1 Front Panel

2.1.1 Insert/Remove Module into/from Node

See 'Dragon PTN Installation and Operation Manual' Ref.[2].

2.1.2 LEDs

The meaning of the LEDs depends on the mode of operation (= boot or normal) in which the PTN-1-10G-LW module currently is running. After plugging in the module or rebooting it, the module turns into the boot operation, see Table 2. After the module has gone through all the cycles in the table below (=rebooted successfully), the module turns into the normal operation, see LEDs in Table 3.

Table 2 LED Indications In Boot Operation

Cycle	PI	PF	FLT	W	WPH	LOS	LA	Spare LED
1	x	---	Slow blinking	---	---	---	---	---
2	x	---	Fast blinking	---	---	---	---	---
3	x	---	---	---	---	---	---	---
4	x	---	x	x	x	x	---	x

x : LED is lit / --- : LED is not lit
 The sub cycle times may vary.
 The entire boot cycle time [1-->4] takes approximately 2 minutes.

Table 3 LED Indications in Normal Operation

LED	Color	Status
PI (=Power Input)	Not lit, dark	+12V power input to the board not OK
	Green	+12V power input to the board OK
PF (=Power Failure)	Not lit, dark	power generation on the board itself is OK
	Red	power generation on the board itself is erroneous
FLT (=FauLT)	Not lit, dark	no other fault or error situation, different from PF, is active on the module
	Red	a fault or error situation, different from PF, is active on the module
W	Not lit, dark	The 10G port is configured as LAN port
	Green	The 10G port is configured as WAN port (=default)
WPH (=WAN PHY)	Not lit, dark	The 10G PHY is configured as LAN PHY for 10GbE (=default)
	Green	The 10G PHY is configured as WAN PHY Sonet OC-192c
LOS (=Loss of Signal)	Not lit, dark	Optical signal OK on the 10G port
	Red	Loss of optical signal on the 10G port
LA (=Link Activity: receive)	Not lit, dark	The link on the 10G port is down
	Yellow lit	The link on the 10G port is up, no receive activity (transmit activity is not shown)
	Yellow blinking	The link on the 10G port is up, with receive activity (transmit activity is not shown)

2.1.3 Connectors

This module has following port:

- ▶ **Port1 = Optical Ethernet port, XFP connector:** An XFP transceiver (10 Gigabit Small Form Factor Pluggable) module must be plugged into this port, in order to interconnect the optical fiber with the PTN-1-10G-LW Interface Module. These XFPs are hot-pluggable and can be replaced from the front, without removing the Interface Module from the node. The ejector clip (see figure below) must be used to lock/unlock the XFP into/from the Interface Module. The XFPs that can be used for this port can be found in Ref. [7] in Table 1.

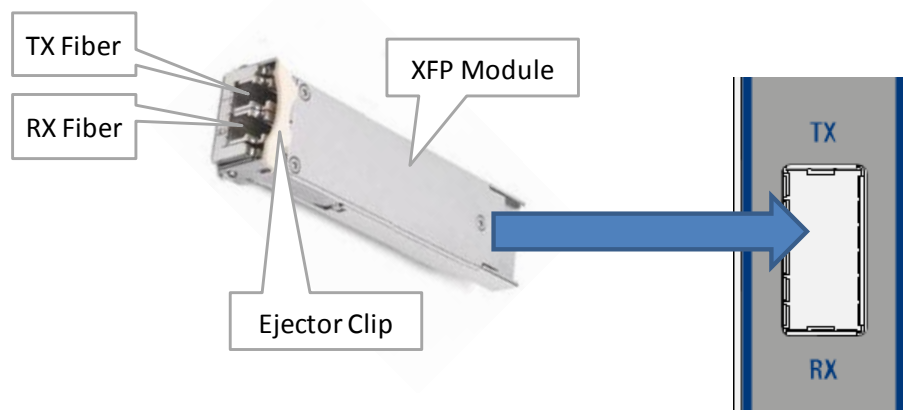

Figure 2 XFP Module / Optical XFP Ethernet Port

2.2 Functional Operation

The PTN-1-10G-LW performs following major tasks:

2.2.1 Media Module for Ethernet: Interfacing to a LAN or WAN Network

WAN ports interconnect nodes within the Dragon PTN network (MPLS-TP) whereas LAN ports interconnect the nodes with their applications.

The front port can be configured individually as LAN or WAN port in HiProvision. By default, each port is configured as WAN port. A LAN port talks Ethernet and a WAN port talks MPLS-TP. As a result, the node can serve as an edge node (or LER = Label Edge Router) where traffic is received on a LAN port, mapped into pseudowire and forwarded to the correct label switched path on a WAN port.

NOTE: The PHY can also be configured as LAN or WAN, see §2.2.2.

For a configured application service, the node can operate as a:

- ▶ LER = Label Edge Router or access node: The node is located on the edge between the LAN and WAN. The node converts Ethernet into MPLS-TP and vice versa.

- ▶ LSR = Label Switching Router: The node is fully located in the WAN. The node has no end-points for the configured application service, it only forwards MPLS-TP traffic via label switched paths.

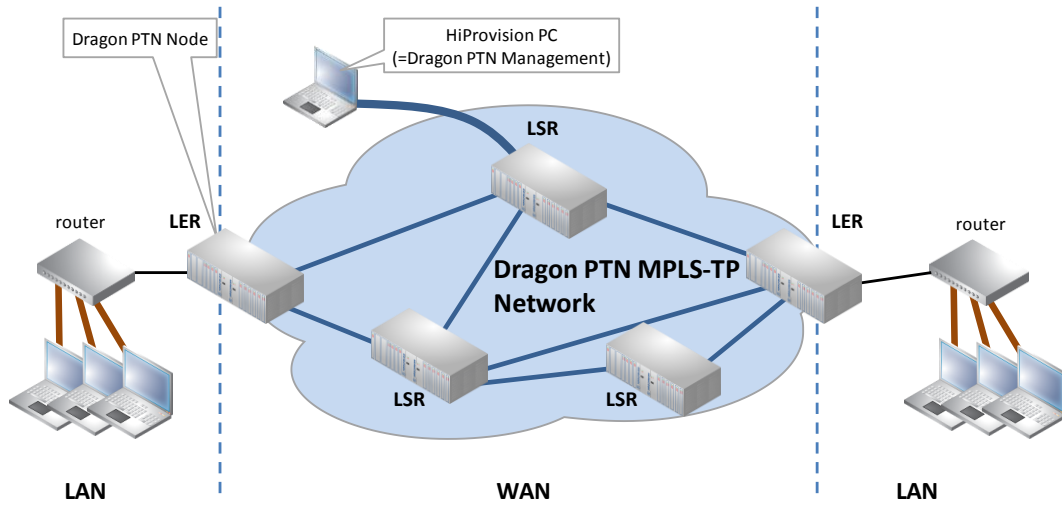

Figure 3 General Example: LAN/WAN

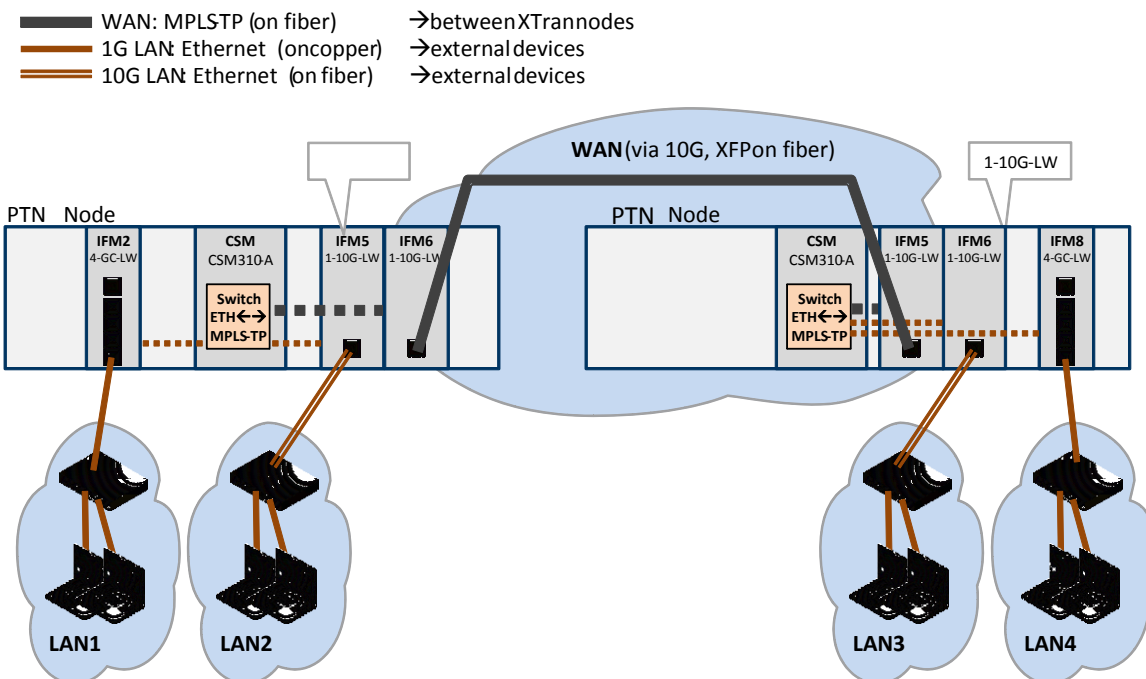

Figure 4 Detailed Example: PTN-1-10G-LW Interfacing to a LAN/WAN Network

2.2.2 LAN/WAN PHY Setting

The PHY can be configured as LAN (=default) or WAN via HiProvision. If you want to interface with SONET or DWDM, configure the PHY as WAN, in all other cases configure the PHY as LAN. The WAN PHY encapsulates Ethernet packets in SONET OC-192c frames and operates at a slightly slower data-rate (9.95328 Gbps) than the local area network (LAN) PHY. When to

use LAN or WAN PHY can also be viewed in the figure below. Make sure that both sides of the link are configured the same, both as LAN PHY or both as WAN PHY.

CAUTION: if you change the WAN PHY setting in HiProvision, and one of the two sides (or nodes) of that link is only reachable via this link, make sure to change that side first. As a result, that node will be unreachable after the change until the node at the other side of the link has been changed as well.

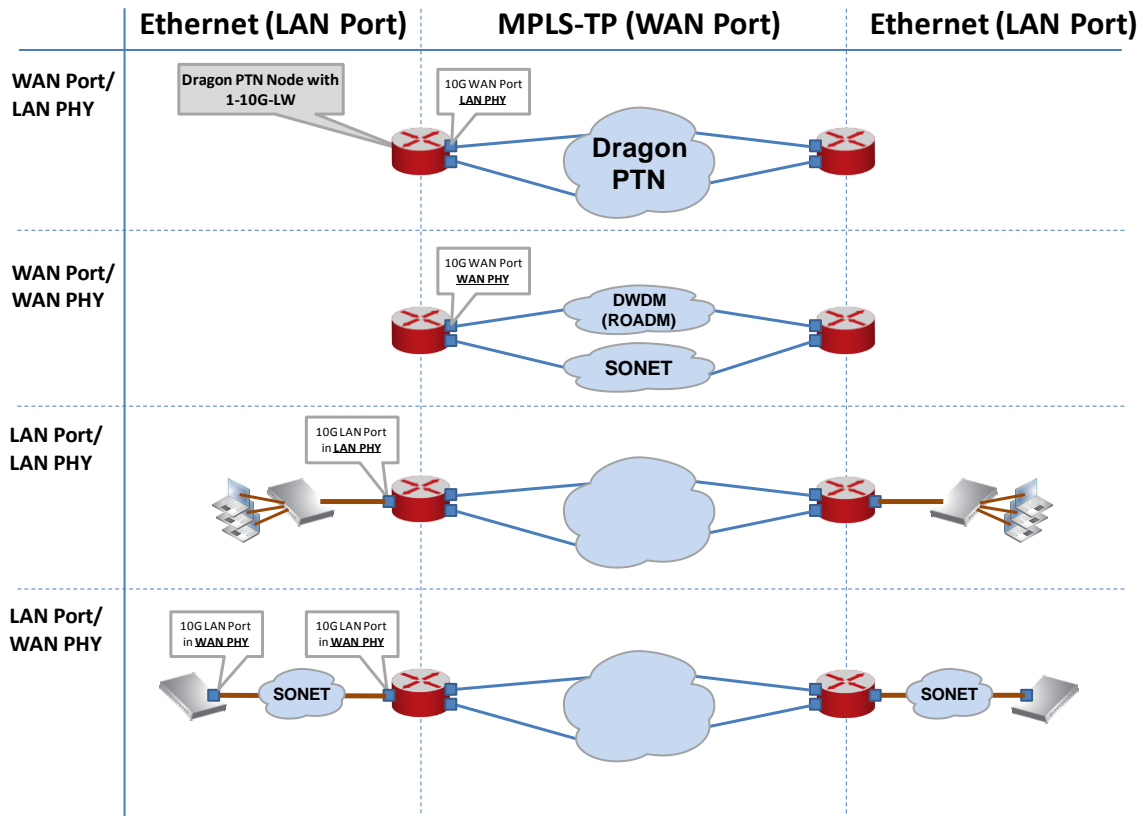

Figure 5 LAN/WAN PHY Cases

2.2.3 Ethernet Service

a. General

The PTN-1-10G-LW Interface Module access or end-points communicate over the Dragon PTN network via an Ethernet service. This service must be configured via HiProvision. This service can operate port or VLAN based. An optional E-Tree can be configured as well on this Ethernet service.

b. Port Based / VLAN Based

- ▶ Port based: Use this mode if all the traffic on a port must be transported transparently in one and the same service;
- ▶ VLAN based/VLAN ID: Use this mode if each VLAN (ID) on a port must have its own service. Ethernet packets with the configured VLAN ID will be forwarded in this service, other VLAN IDs and untagged packets will be dropped. This behavior can be overruled by a more advanced VLAN processing in the 'VLAN Tagging/Untagging' feature in HiProvision. This feature also supports VLAN translation which replaces VLAN ID 'x' into VLAN ID 'y'.

c. E-Tree

An E-Tree is a rooted (not routed) point-to-multipoint partial service within a programmed Ethernet service. E-Tree can be used as a security precaution to separate different customers (=leaves) using the same Ethernet service while accessing one or more ISPs (=roots).

When an E-Tree is used, each service endpoint is designated as either **leaf** or **root**. A leaf can only communicate with a root. A root can communicate with all the roots and leaves.

NOTE: The PTN-1-10G-LW Interface Module has one port that can be used as a LAN or WAN port. For extra LAN or WAN ports, additional Interface Modules must be installed.

2.2.4 Voice Service

The PTN-1-10G-LW Interface Module port can be configured in the Ethernet part of the Voice service. See Ref. [1] and Ref.[7] in Table 1 for more information on the Voice service.

2.2.5 I/O with the Central Switching Module (=CSM)

The PTN-1-10G-LW module receives traffic (Ethernet or MPLS-TP) via its front panel port and forwards this to the CSM via the backplane. The CSM does all the processing on this data (synchronization, CRC checks, conversions, switching...). The resulting data will be forwarded via the backplane to one of the Interface Modules in the node.

2.2.6 Synchronization / Clock Distribution / Network Timing

The Dragon PTN network provides a number of mechanisms to perform synchronization / clock distribution / network timing. The CSM makes sure that all the included Interface Modules in the node are synchronized. See the table below for an overview of the mechanisms that are supported on the PTN-1-10G-LW module.

It means that the front port of the PTN-1-10G-LW module can be used to recover a clock from an incoming data stream and redistribute this clock via an outgoing datastream.

Table 4 Synchronization / Clock Distribution / Network Timing Overview

Mechanism	Domain	What is Synchronized?	Purpose
SyncE	Network wide	Clock Frequency	Distribute a synchronous clock, based on a PRC (=Primary Reference Clock), network wide over all the nodes that need it.
PTP IEEE 1588v2	Network wide	Timestamping	A protocol to synchronize real-time clocks (timestamping) in Dragon PTN network elements and/or connected devices.

a. SyncE (=Synchronous Ethernet)

See the manuals in Ref.[1] and Ref.[4], [4b] for more detailed information;

b. PTP IEEE 1588v2 (=Precision Time Protocol)

See the HiProvision manual in Ref.[1] for more detailed information.

2.2.7 EFM-F IEEE 802.3ah (=Ethernet in the First Mile – Fiber) (Future)

Future planned.

2.2.8 MPLS-TP Compliancy

See the CSM manual in Ref.[4], [4b].

2.2.9 Storm Control on Ethernet LAN Port

NOTE: Storm Control is not relevant/supported on WAN Ports;

A traffic storm is the growing of excessive network traffic due to Ethernet packets flooding the LAN. Such a storm can for example occur because of a data loop in the network due to no or misconfiguration of MSTP. These storms degrade the network performance and must be avoided whenever possible.

The storm control feature:

- ▶ is an extra protection against these traffic storms;
- ▶ can be configured on the Interface Module ports;
- ▶ limits the amount of unlearned received data (Unicast, Broadcast, Multicast) on the LAN port ingress or input side;
- ▶ limits the amount of transmitted data (all data) on the LAN port egress or output side;
- ▶ Data that exceeds the configured limitations will be dropped. As a result, a possible data storm cannot overload the node processor or the node will limit outgoing data.

See Ref. [1] in Table 1 for more configuration information in HiProvision.

2.2.10 BPDU Guard on Ethernet LAN Port

NOTE: BPDU Guard is not relevant/supported on WAN Ports;

BPDU Guard (=Bridge Protocol Data Unit) is a LAN port property or feature that:

- ▶ shuts down the LAN port when a BPDU packet enters this port;
- ▶ sends out dummy BPDU packets.

As a result, this feature or Interface Module:

- ▶ protects the network against possible loops created via this Interface Module, although this Interface Module does not support MSTP;
- ▶ protects a running MSTP protocol somewhere else in the Dragon PTN network from external MSTP influences via this LAN port, e.g. root bridge protection etc...

See Ref. [1] in Table 1 for more configuration information in HiProvision.

2.2.11 MRP (=Media Redundancy Protocol) Support

The MRP is a protocol (IEC 62439-2) especially designed for industrial applications which need a predictable fail-over time. This protocol can only be used in a ring-topology network and makes sure that the ring network stays loop-free. MRP does in ring networks what spanning tree does in meshed networks but with much faster convergence times. The ring has one selected MR Manager (MRM) and a number of MR Clients (MRC). The two Dragon PTN nodes act as MRC. See Ref. [1] in Table 1 for more configuration information in HiProvision.

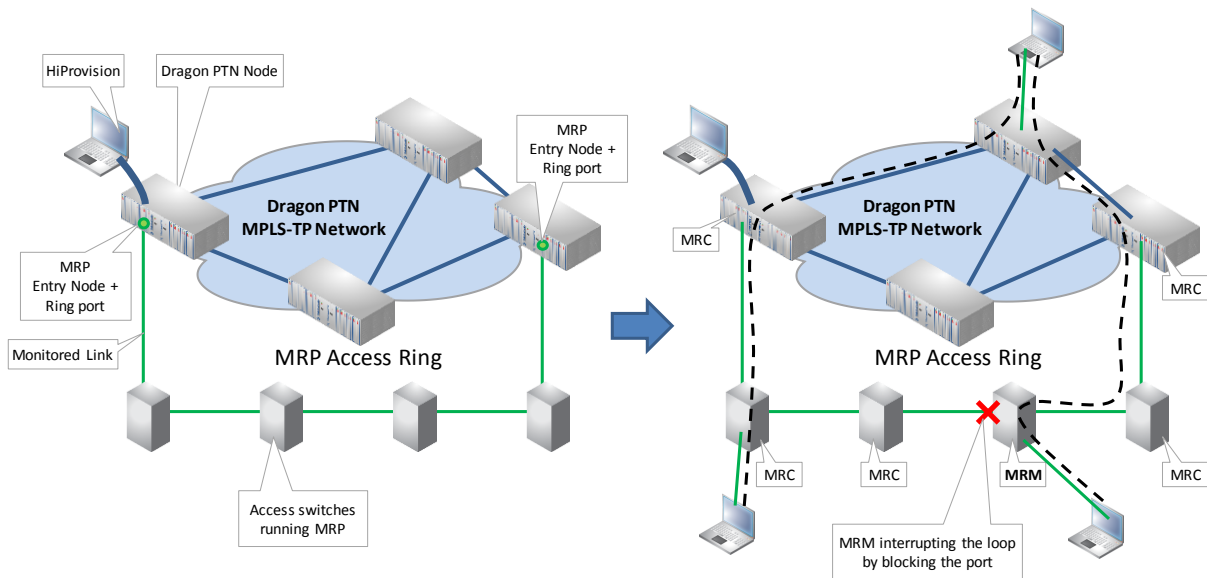

Figure 6 MRP: General Example

2.3 Onboard Interfaces

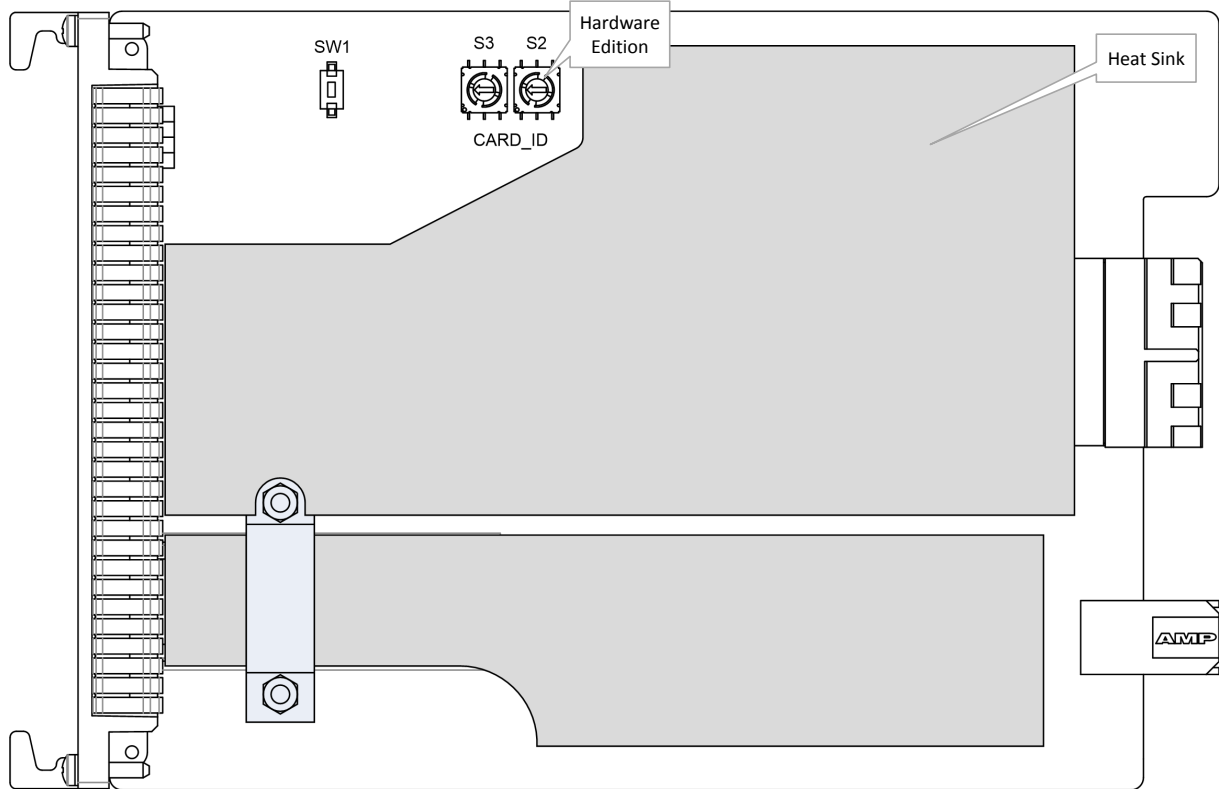

Figure 7 PTN-1-10G-LW: Side View

2.3.1 Heat Sink

A heat sink is required for the natural cooling of this PTN-1-10G-LW module.

2.3.2 Straps

No user relevant straps.

2.3.3 Rotary DIP Switches

a. Hardware Edition

The Hardware Edition (labeled as CARD_ID) is set in decimal code using rotary switches S2 to S3 (S3 = most significant). It can be read out as well via HiProvision. This edition has been factory set and **MUST NOT BE CHANGED!**

Example: Setting S3='0' and S2='5' indicates Hardware Edition '5' (dec).

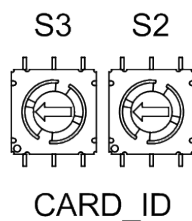

Figure 8 Hardware Edition

3. MODULE SPECIFICATIONS

3.1 General Specifications

For general specifications like temperature, humidity, EMI ... see Ref.[9] in Table 1.

3.2 Other Specifications

Table 5 Other Specifications

Description	Value
Weight	0.410 kg / 0.9 lb (with XFP) 0.370 kg / 0.8 lb (without XFP)
MTBF	117 years at 25°C/77°F
Power Consumption	12W (measured at 25°C/77°F, with XFPs data transport)
Module Size	width: 20.32 mm / 0.8 inches height: 126 mm / 4.96 inches depth: 195 mm / 7.68 inches

3.3 Ordering Information

- ▶ PTN-PTN-1-10G-LW: 942 236-004.

4. ABBREVIATIONS

BPDU	Bridge Protocol Data Unit
CE	Conformité Européenne
CSM	Central Switching Module
DWDM	Dense Wavelength Division Multiplexing
EFM-F	Ethernet in the First Mile Over Point-to-Point Fiber
EMI	Electromagnetic Interference
FLT	Fault
IEC	International Electrotechnical Commission
IEEE	Institute of Electrical and Electronics Engineers
IETF	Internet Engineering Task Force
ISP	Internet Service Provider
LA	Link Activity
LAN	Local Area Network
LER	Label Edge Router
LOS	Loss of Signal
LSR	Label Switching Router
LVD	Low Voltage Directive

MRC	Media Redundancy Clients
MRM	Media Redundancy Manager
MRP	Media Redundancy Protocol
MSTP	Multiple Spanning Tree
MTBF	Mean Time Between Failures
PF	Power Failure
PHY	Physical interface
PI	Power Input
PSU	Power Supply Unit
PTN	Packet Transport Network
PTP	Precision Time Protocol
ROADM	Reconfigurable Optical Add-Drop Multiplexer
SONET	Synchronous Optical Network
SyncE	Synchronous Ethernet
WAN	Wide Area Network
WPH	WAN PHY, Packet over SDH
XFP	10 Gigabit Small Form Factor Pluggable Module