



**HIRSCHMANN**

A **BELDEN** BRAND

# User Manual

Installation

Dragon PTN

Interface Module PTN-4-CODIR

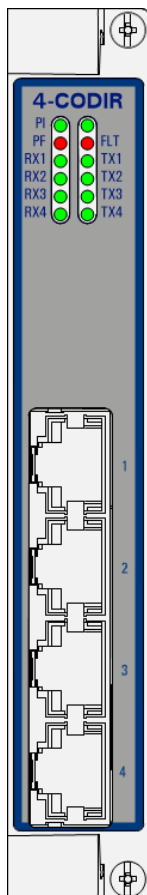

The naming of copyrighted trademarks in this manual, even when not specially indicated, should not be taken to mean that these names may be considered as free in the sense of the trademark and tradename protection law and hence that they may be freely used by anyone.

© 2020 Hirschmann Automation and Control GmbH

Manuals and software are protected by copyright. All rights reserved. The copying, reproduction, translation, conversion into any electronic medium or machine scannable form is not permitted, either in whole or in part. An exception is the preparation of a backup copy of the software for your own use.

The performance features described here are binding only if they have been expressly agreed when the contract was made. This document was produced by Hirschmann Automation and Control GmbH according to the best of the company's knowledge. Hirschmann reserves the right to change the contents of this document without prior notice. Hirschmann can give no guarantee in respect of the correctness or accuracy of the information in this document.

Hirschmann can accept no responsibility for damages, resulting from the use of the network components or the associated operating software. In addition, we refer to the conditions of use specified in the license contract.

You can get the latest version of this manual on the Internet at the Hirschmann product site ([www.hirschmann.com](http://www.hirschmann.com)).

Hirschmann Automation and Control GmbH  
Stuttgarter Str. 45-51  
72654 Neckartenzlingen  
Germany

## Contents

<b>1.</b>	<b>INTRODUCTION .....</b>	<b>5</b>
<b>1.1</b>	<b>General.....</b>	<b>5</b>
<b>1.2</b>	<b>Manual References .....</b>	<b>6</b>
<b>2.</b>	<b>MODULE DESCRIPTION .....</b>	<b>7</b>
<b>2.1</b>	<b>Front Panel .....</b>	<b>7</b>
2.1.1	Insert/Remove Module into/from Node .....	7
2.1.2	LEDs.....	8
2.1.3	RJ-45 Ports and Cables.....	8
<b>2.2</b>	<b>Functional Operation .....</b>	<b>9</b>
2.2.1	General .....	9
2.2.2	ITU-T G.703 Code Conversion 64kbps .....	10
2.2.3	CES: SAToP .....	10
2.2.4	CES: CESoPSN .....	11
2.2.5	Hitless Switching.....	11
2.2.6	Single Path .....	12
2.2.7	CODIR - SAToP: Mux/Demux to E1 on 4-E1-L IFM.....	13
2.2.8	Delay Comparison in CES (Features) .....	14
2.2.9	I/O with the Central Switching Module (=CSM) .....	14
2.2.10	Synchronization / Clock Distribution / Network Timing.....	14
2.2.11	Test and Loopback Selftests .....	17
<b>2.3</b>	<b>Onboard Interfaces .....</b>	<b>17</b>
2.3.1	Straps .....	17
2.3.2	DIP Switches .....	17
<b>3.</b>	<b>TDM FRAMES/PACKET .....</b>	<b>18</b>
<b>3.1</b>	<b>General.....</b>	<b>18</b>
<b>3.2</b>	<b>Bandwidth .....</b>	<b>18</b>
<b>3.3</b>	<b>Delay .....</b>	<b>18</b>
3.3.1	General .....	18
3.3.2	Delay Parameters .....	19
3.3.3	Estimated Delay Calculation and Formulas .....	19
3.3.4	Estimated Delay Examples.....	20
3.3.5	Differential Delay.....	20
<b>3.4</b>	<b>Tuning CES = Tuning TDM Frames/Packet.....</b>	<b>21</b>
<b>4.</b>	<b>MODULE SPECIFICATIONS .....</b>	<b>21</b>
<b>4.1</b>	<b>General Specifications.....</b>	<b>21</b>
<b>4.2</b>	<b>Other Specifications.....</b>	<b>21</b>
<b>4.3</b>	<b>Ordering Information .....</b>	<b>21</b>
<b>5.</b>	<b>ABBREVIATIONS .....</b>	<b>22</b>

## List of figures

Figure 1 Codirectional Interface .....	5
Figure 2 General 64 kbps Example .....	6
Figure 3 IFM In Aggregation Nodes .....	7
Figure 4 IFM in Core Nodes .....	7
Figure 5 RJ-45 Connector .....	8
Figure 6 Detailed Function 64 kbps Example .....	9
Figure 7 ITU-T G.703 Code Conversion 64 kbps .....	10
Figure 8 General SAToP Example .....	11
Figure 9 General CESoPSN Example .....	11
Figure 10 Hitless Switching .....	12
Figure 11 Single Path Enabled .....	13
Figure 12 Single Path Disabled .....	13
Figure 13 CODIR – SAToP: Mux/Demux to E1 on 4-E1-L IFM .....	14
Figure 14 Clocking: Application D Slaves to Application A via Dragon PTN .....	15
Figure 15 Clocking: Both Application A and D Slave to Dragon PTN Clock Master .....	15
Figure 16 4-CODIR: Side View .....	17
Figure 17 Hardware Edition .....	18
Figure 18 CESoPSN Bandwidth .....	18
Figure 19 Delays .....	19
Figure 20 Differential Delay .....	20

## List of Tables

Table 1 Manual References .....	6
Table 2 LED Indications In Boot Operation .....	8
Table 3 LED Indications In Normal Operation .....	8
Table 4 RJ-45 Connector: Pin Assignments .....	9
Table 5 Difference Between Protection and Hitless Switching .....	12
Table 6 Delay Comparison in CES (Features) .....	14
Table 7 Clocking Parameters on Port & Service Level .....	16
Table 8 Estimated Delay Formulas .....	20
Table 9 Estimated Delay ( $\mu$ s) Examples .....	20
Table 10 Other Specifications .....	21

## 1. INTRODUCTION

### 1.1 General

This document is valid as of Dragon PTN Release 4.3DR.

The 4-CODIR interface module (=IFM) can transport four 64 kbps links, point-to-point over the Dragon PTN network according the ITU G.703 standard, see §2.2.2 for more information.

4-CODIR refers to '4 ports – Codirectional Interface'. The term 'Codirectional' is used to describe an interface in which the information and its associated timing signal are transmitted into the same direction. The information and timing signal are both embedded in the same data stream, there is no separate clock transmission. The receiver will derive the clock from the incoming data stream. See figure below.

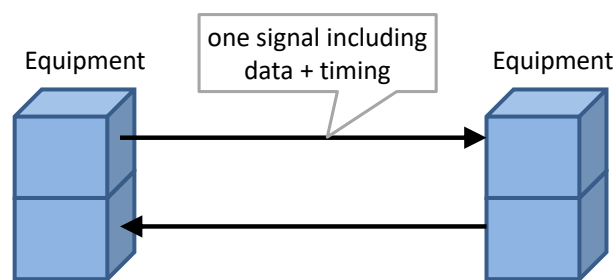

**Figure 1 Codirectional Interface**

This IFM converts the incoming data from the 64 kbps link into MPLS-TP packets over the Dragon PTN network, and vice versa. The destination IFM must also compensate for possible jitter and network delays to keep everything synchronized. A packetized TDM service is called a Circuit Emulation Service (=CES). A maximum of 4 CESs can be configured per 4-CODIR module.

**NOTE:** A 64kbps link = E0 link; An E1 link can carry 32 E0 links.

Verify the 'Dragon PTN Bandwidth Overview' manual (Ref. [100] in Table 1) to see in which node and IFM slot this IFM can be used.

The main supported features are:

- ▶ Packetizing of 64 kbps data
- ▶ Codirectional
- ▶ LAN function
- ▶ Services (See Ref. [2Leg] in Table 1 for the creation of services in HiProvision)
  - ▶ SAToP (=Structured Agnostic TDM over Packet);
  - ▶ CESoPSN (=CES over Packet Switched Network);
  - ▶ Hitless Switching / Single Path;
  - ▶ Mux/Demux (SAToP): Possible to mux/demux this C37.94 service together with other services to/from one E1 port on a 4-E1-L IFM. Services of different protocol types can be muxed/demuxed.

A general 64 kbps CODIR example can be found in the next figure:

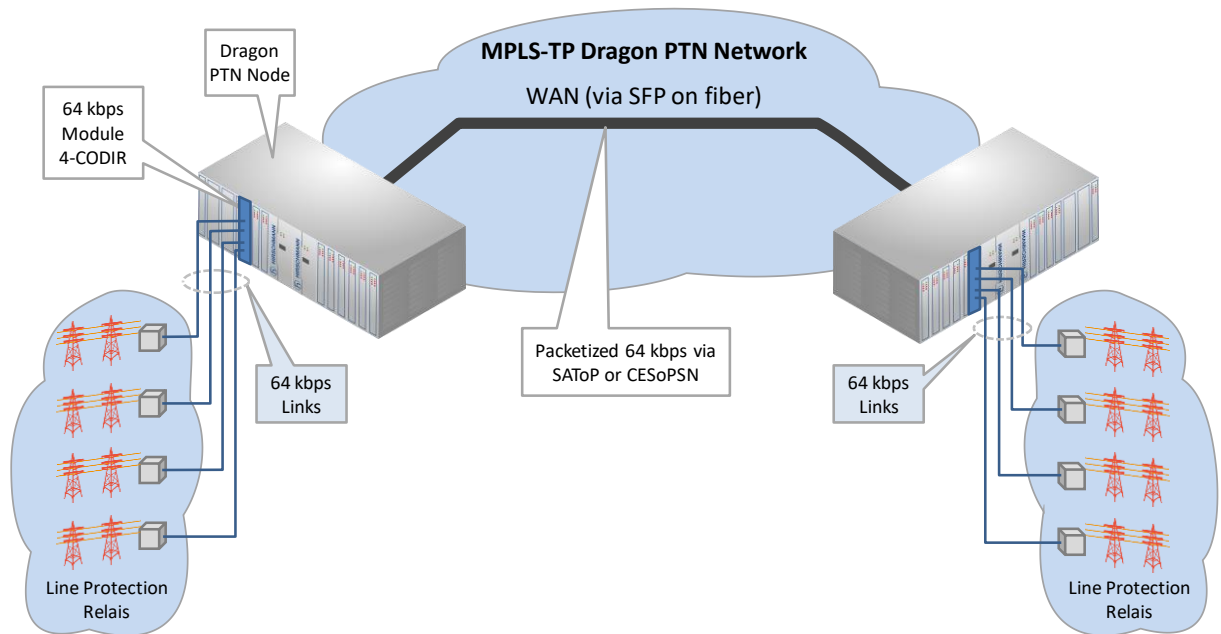

**Figure 2 General 64 kbps Example**

## 1.2 Manual References

Table 1 is an overview of the manuals referred to in this manual. ‘&’ refers to the language code, ‘\*’ refers to the manual issue. All these manuals can be found in the HiProvision (=Dragon PTN Management System) Help function.

**Table 1 Manual References**

Ref.	Number	Title
[1]	DRA-DRM801-&-*	Dragon PTN Installation and Operation
[2Mgt]	DRA-DRM830-&-*	HiProvision Management Operation
[2Leg]	DRA-DRM832-&-*	Dragon PTN Legacy Services
[2Net]	DRA-DRM833-&-*	Dragon PTN Network Operation
[4]	DRB-DRM803-&-*	Dragon PTN Switching Module: PTN-CSM310-A/ PTN-CSM540-A
[5]	DRE-DRM805-&-*	Dragon PTN Interface Module: PTN-4-E1-L/ PTN-4-T1-L
[6]	DRA-DRM810-&-*	Dragon PTN General Specifications
[7]	DRE-DRM818-&-*	Dragon PTN Interface Module: PTN-16-E1-L/ PTN-16-T1-L
[100]	DRA-DRM828-&-*	Dragon PTN Bandwidth Overview

**2. MODULE DESCRIPTION**

**2.1 Front Panel**

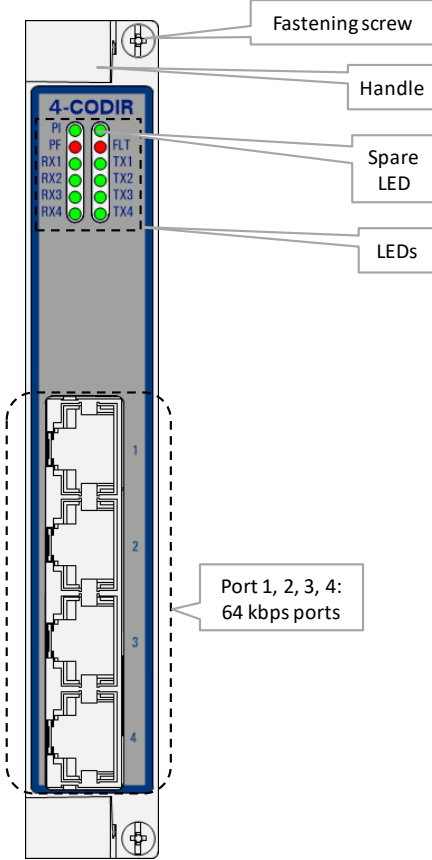

**Figure 3 IFM In Aggregation Nodes**

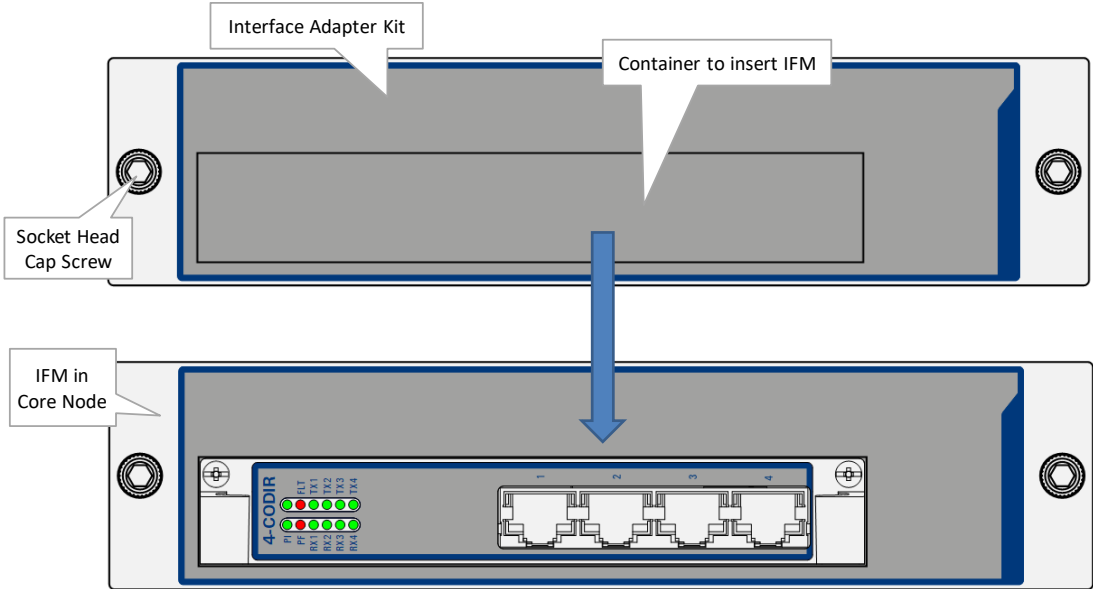

**Figure 4 IFM in Core Nodes**

**2.1.1 Insert/Remove Module into/from Node**

See 'Dragon PTN Installation and Operation Manual' Ref.[1].

### 2.1.2 LEDs

The meaning of the LEDs depends on the mode of operation (= boot or normal) in which the 4-CODIR module currently is running. After plugging in the module or rebooting it, the module turns into the boot operation, see Table 2. After the module has gone through all the cycles in the table below (=rebooted successfully), the module turns into the normal operation, see LEDs in Table 3.

**Table 2 LED Indications In Boot Operation**

Cycle	PI	PF	FLT	Spare LED	RX[1..4]	TX[1..4]
1	✓	---	Slow blinking	---	---	---
2	✓	---	Fast blinking	---	---	---
3	✓	---	---	---	---	---
4	✓	---	✓	✓	✓	✓
✓ : LED is lit / --- : LED is not lit The sub cycle times may vary. The entire boot cycle time [1→ 4] takes approximately 2 minutes.						

**Table 3 LED Indications In Normal Operation**

LED	Color	Status
PI (=Power Input)	Not lit, dark	+12V power input to the board not OK
	Green	+12V power input to the board OK
PF (=Power Failure)	Not lit, dark	power generation on the board itself is OK
	Red	power generation on the board itself is erroneous
FLT (=FauLT)	Not lit, dark	no other fault or error situation, different from PF, is active on the module
	Red	a fault or error situation, different from PF, is active on the module
Spare	Not lit, Green	spare
RX<port n°>	Not lit, dark	No service programmed on port<n>
	Green, lit	Service programmed on port<n>, data received on front port<n>
	Green, blinking	Service programmed on port<n>, no data received on front port<n>
TX<port n°>	Not lit, dark	No service programmed on port<n>, no TX AIS sent
	Green, lit	Service programmed on port<n>, data received on backplane (=network) side
	Green, blinking	Service programmed on port<n>, no data received on backplane (=network) side

### 2.1.3 RJ-45 Ports and Cables

The 4-CODIR module provides four of these ports and each port connector has eight pins. Each port provides one tip/ring pair. See the figure and table below for an overview and description. The 120 Ω E1 cable (942 256-201) can be ordered to connect these ports.

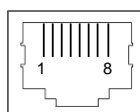

**Figure 5 RJ-45 Connector**



**Table 4 RJ-45 Connector: Pin Assignments**

Pin Number	Description	Cable Wire Colors
1	Rx (Receive) RING	OG
2	Rx (Receive) TIP	WH/OG
3	Not connected	-
4	Tx (Transmit) RING	BU
5	Tx (Transmit) TIP	WH/BU
6, 7, 8	Not connected	-

## 2.2 Functional Operation

### 2.2.1 General

An application network (e.g. LAN1) can be connected to the MPLS-TP Dragon PTN network via one of the 4 front ports. The 4-CODIR module can interface with four 64kbps lines. In Figure 2, a common functional setup is shown.

In Figure 6 below, a more detailed functional setup is shown. A LAN1 network interfaces the Dragon PTN node via the front ports on the 4-CODIR module. The 4-CODIR converts this traffic into Ethernet traffic on the backplane. The Central Switching Module (= CSM, see Ref. [4] in Table 1) converts this Ethernet traffic into packetized MPLS-TP and transmits it via an Ethernet IFM (e.g. 4-GC-LW) onto the Dragon PTN MPLS-TP network. The packetizing of 64 kbps occurs via CES: SAToP (see §2.2.3) or CES: CESoPSN (see §2.2.4) technique.

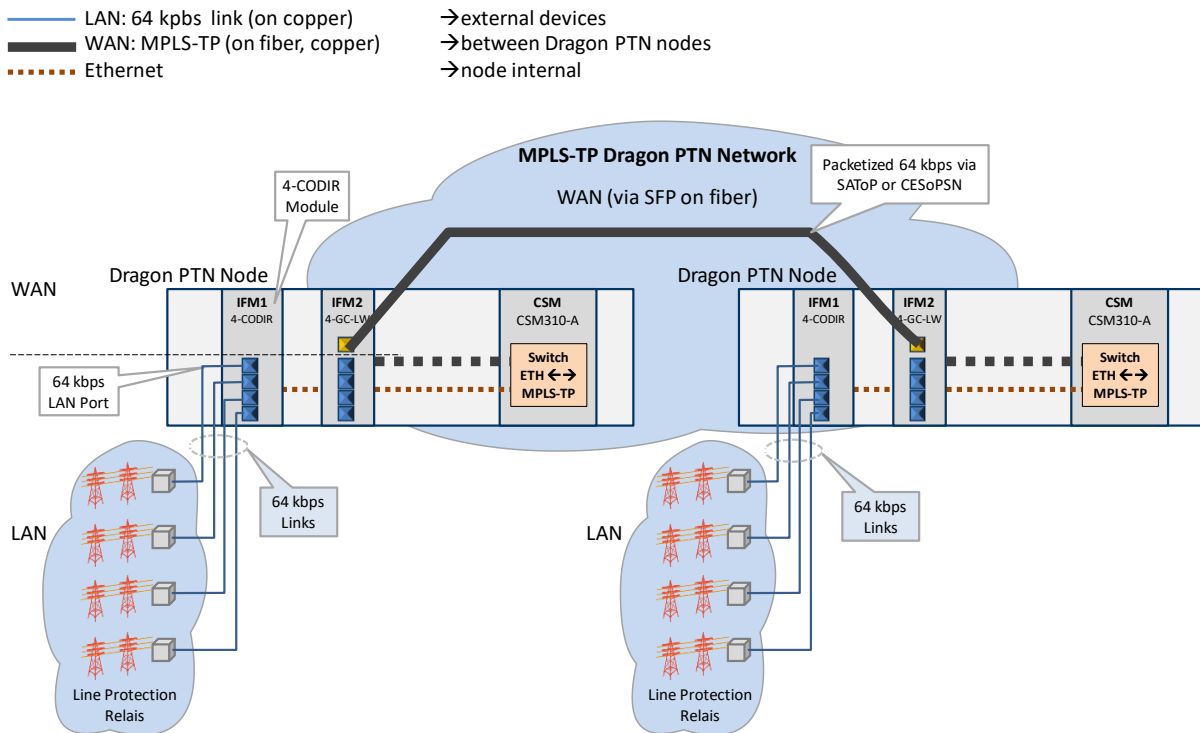

**Figure 6 Detailed Function 64 kbps Example**

## 2.2.2 ITU-T G.703 Code Conversion 64kbps

The ITU-T G.703 standard defines for the 64 Kbps codirectional interface the following five steps for AMI coding (step1->5) / decoding (step5->1) a binary data stream:

1. (network side) A 64 kbps bit period is divided into four unit intervals;
2. A binary one is coded as a block of the following four bits: 1100;
3. A binary zero is coded as a block of the following four bits: 1010;
4. The binary signal is converted into a three-level signal by alternating the polarity of consecutive blocks; This is the AMI encoding or Alternate Mark Inversion.
5. (front side) The alternation in polarity of the blocks is violated every eighth block. The violation block marks the last bit in an octet.

The figure below illustrates these conversion rules. The physical interface consists of four signals (Transmit, Tip, Transmit Ring, Receive Tip and Receive Ring). A 64 kbps Tip-Ring pair is a balanced twisted pair (120 Ω). The data transmission through a pair is bipolar and AMI, i.e. an impulse on the line corresponds to a logical "1" (mark) and a space with a logical "0".

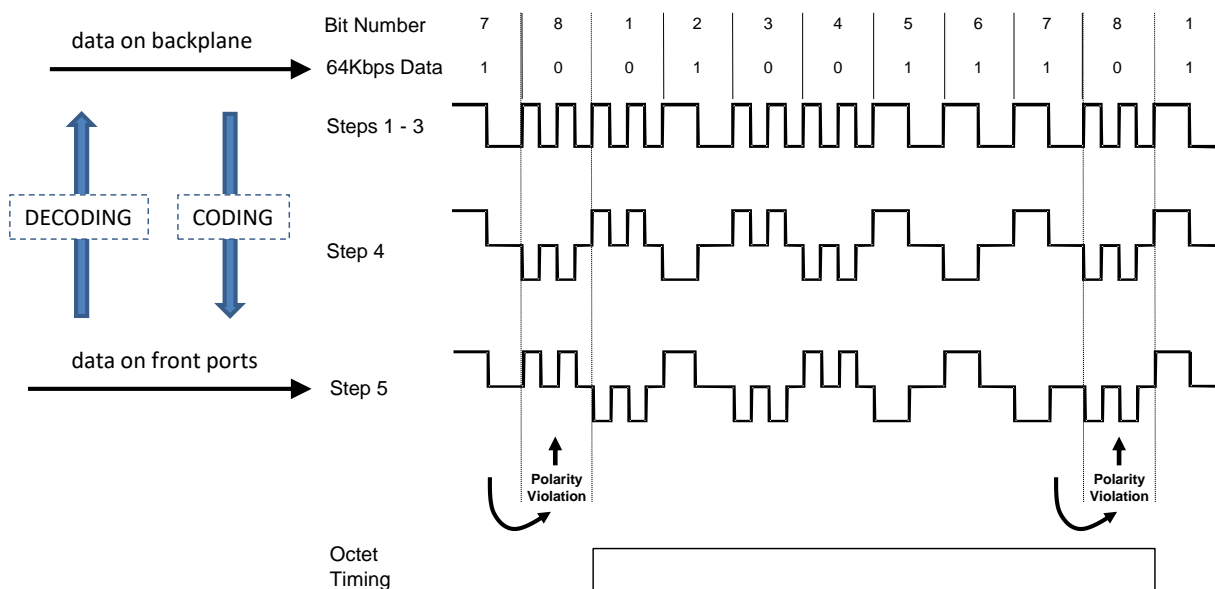

Figure 7 ITU-T G.703 Code Conversion 64 kbps

## 2.2.3 CES: SAToP

SAToP is a point-to-point CES which sends transparently an entire E1 frame from the source to the destination 4-CODIR over the MPLS-TP network. One timeslot is used for transporting the 64 kbps channel 'X'. The entire frame = all data + synchronization + alignment timeslots = 32 timeslots. One SAToP service can be configured per port.

This way of transportation consumes more bandwidth over the Dragon PTN network than CESoPSN (see next paragraph), but has less differential delay than CESoPSN. If delay must be as low as possible, use SAToP instead of CESoPSN to transport your 64 k CESoPSN bps channel.

**NOTE:** Each end-point or 64 kbps port must be located in a different node.

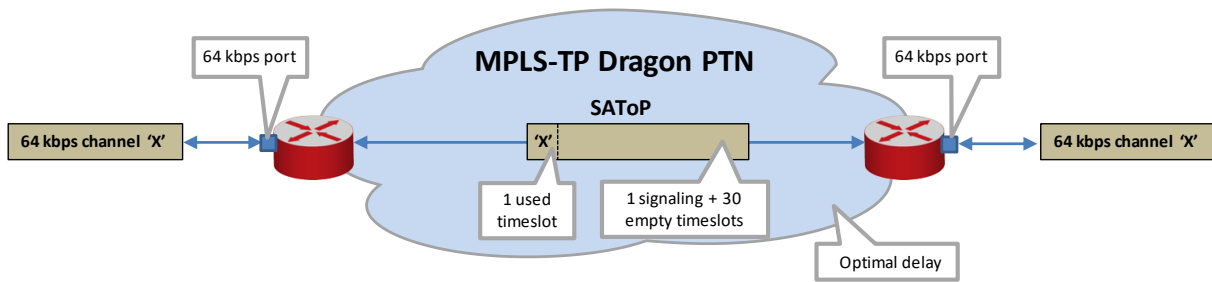
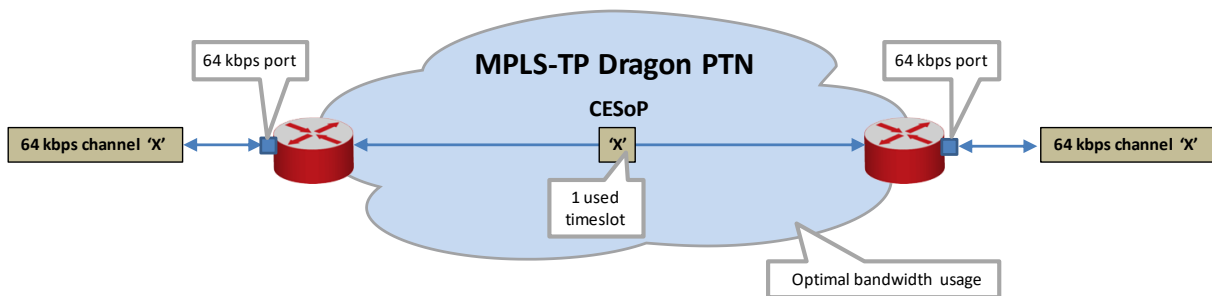

**Figure 8 General SAToP Example**

### 2.2.4 CES: CESoPSN

CESoPSN is a point-to-point CES which only sends one E1 timeslot including the 64 kbps channel, over the MPLS-TP Dragon PTN network. This way of transportation consumes less bandwidth over the Dragon PTN network than SAToP, but has more differential delay than SAToP. If delay is not an issue, use CESoPSN to transport your 64 kbps channel.

Each end-point or port must be located in a different node.



**Figure 9 General CESoPSN Example**

### 2.2.5 Hitless Switching

Hitless Switching is a feature within SAToP/CESoPSN that provides a safe 64 kbps redundant connection where no data or synchronization is lost when switching from the active to the backup path or vice versa, e.g. because of cable break. The total delay over the network remains nearly constant during switch-over. Redundancy via Hitless Switching is obtained via completing the list below:

- ▶ creating two independent point-to-point tunnels without protection;
- ▶ setting the Hitless Switching on at service creation time in HiProvision.

**NOTE:** See Ref. [2Net]/[2Leg] in Table 1 for the creation of tunnels/services;

On the source side, with Hitless Switching enabled, the E1/T1 IFM duplicates each packet on a second tunnel (e.g. Tunnel y, see figure below). Each packet also contains a 16 bit sequence number. Different tunnels mean different paths through the network, with each path its own delay. Different delays result in a slow and a fast path.

On the destination side, with Hitless Switching enabled, the 4-CODIR IFM buffers the fastest path and forwards packets from the slowest path on the 64 kbps link. Packets will be processed according a packet sequence number.

Hitless Switching is a redundant mechanism but differs from Protection Switching, see the table below for an overview. So if redundancy is needed in the service, either choose Hitless Switching or Protection Switching, mixing up both mechanisms is not allowed. Depending on the choice, settings must be done at tunnel creation time and/or service creation time.

When Hitless Switching has been enabled, the CES can only start up with two links up, coming out of a two-links-down situation (except when Single Path has been enabled, see §2.2.6).

See §2.2.8 for a delay comparison within CES depending on the enabled sub features, see also further on.

**Table 5 Difference Between Protection and Hitless Switching**

	64 kbps Protection Switching	64 kbps Hitless Switching
required tunnel type	1 point-to-point tunnel	2 point-to-point tunnels
tunnel protection type	1:1;	none; the redundancy is created via two independent point-to-point tunnels.
service parameter	Hitless Switching = disabled	Hitless Switching = enabled
at switch-over	possible data loss	no data or synchronization loss
total delay	less than hitless switching	more than protection switching

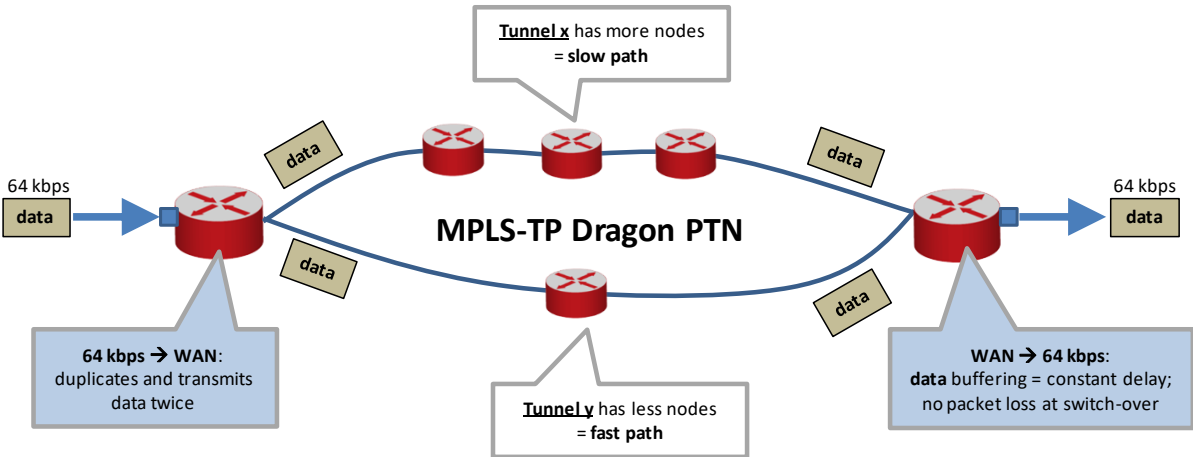

**Figure 10 Hitless Switching**

**2.2.6 Single Path**

The Single Path feature is a sub feature of Hitless Switching (see §2.2.5). It influences the start-up behavior of the Hitless Switching mechanism:

- ▶ enabled: The CES can already start up with only one link up, coming out of a two-links-down situation; this setting results in bigger delays because of bigger buffers.
  - ▶ if the fastest path came up first:
    - ▶ the CES starts up according to the fastest path;
    - ▶ possible CES interrupt or minor packet loss when the slowest path comes up later on;
  - ▶ if the slowest path came up first:

- ▶ the CES starts up according to the slowest path;
- ▶ no CES interrupt or packet loss when the fastest path comes up later on;

See §2.2.8 for a delay comparison within CES depending on the enabled sub features, see also further on.

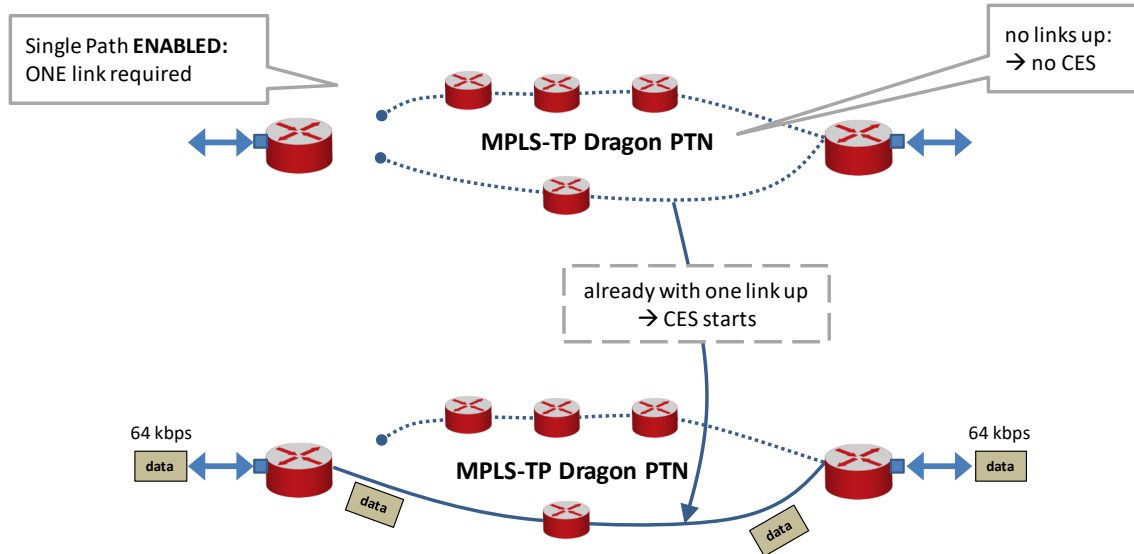

**Figure 11 Single Path Enabled**

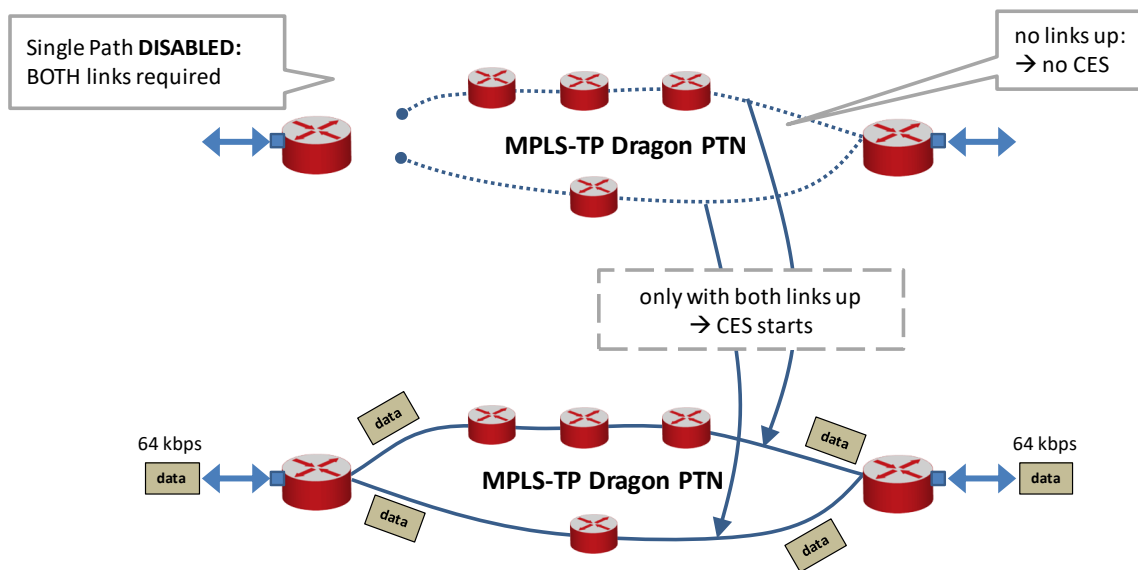

**Figure 12 Single Path Disabled**

### 2.2.7 CODIR - SAToP: Mux/Demux to E1 on 4-E1-L IFM

When using CODIR SAToP services, it is possible to mux/demux this 64 kbps CODIR protocol, together with other same or different protocols to/from port1 on a 4-E1-L IFM. This can be done via selecting the Mux/Demux option in HiProvision at service creation time.

A maximum of 4 point-to-point SAToP services that support Mux/Demux, regardless the used protocol, can be muxed to that same E1 port1.

**NOTE:** All protocols that support Mux/Demux can be found in Ref. [2Leg] in Table 1.

Per extra muxed service to that E1 port1, an extra available E1 port on that 4-E1-L IFM is required and will be disabled for other service connections. E.g, a second muxed service disables the next available port (starting with the lowest port number first) on that 4-E1-L IFM.

The example below shows muxing/demuxing of C37.94, Serial and CODIR 64 kbps to E1. All ports on the 4-E1-L IFM will be in use in this example because 4 services are muxed/demuxed, but only port1 will transmit/receive the muxed data stream.

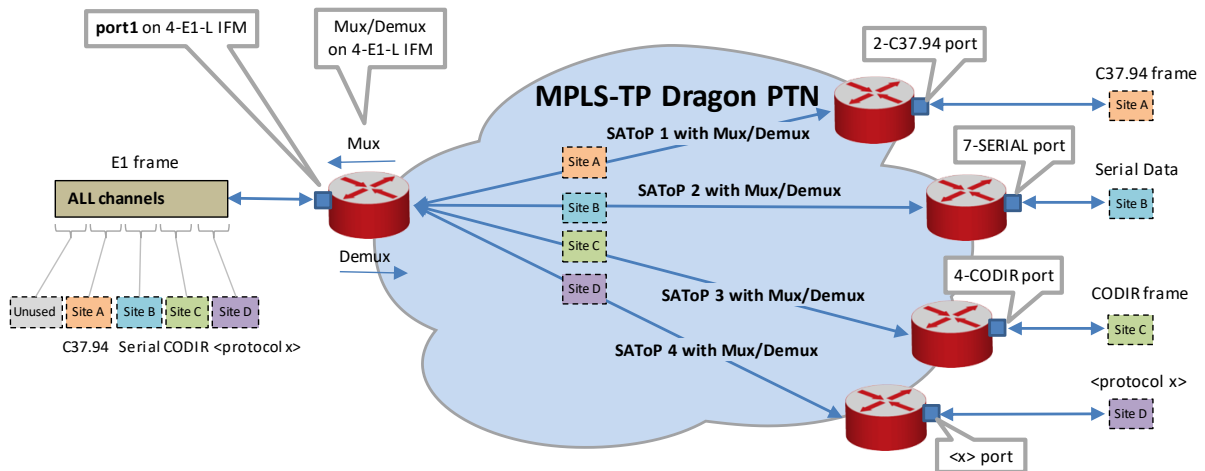

Figure 13 CODIR – SAToP: Mux/Demux to E1 on 4-E1-L IFM

## 2.2.8 Delay Comparison in CES (Features)

Table 6 Delay Comparison in CES (Features)

CES	Hitless Switching	Single Path	Resulting Delay
✓	---	---	lowest
✓	✓	---	medium
✓	✓	✓	highest
✓ = enabled; --- = disabled			

## 2.2.9 I/O with the Central Switching Module (=CSM)

The 4-CODIR module receives 64 kbps traffic via its front panel ports and converts this into Ethernet traffic which is forwarded to the CSM via the backplane. The CSM does all the processing on this data (synchronization, CRC checks, conversions, switching...). The CSM converts this data into MPLS-TP packets and transmits it an Ethernet IFM (e.g. 4-GC-LW) onto the WAN. On the destination side, the same processing occurs in reverse order.

## 2.2.10 Synchronization / Clock Distribution / Network Timing

**CAUTION: Make sure to configure/verify the clocking parameters below.**

The Dragon PTN network provides a number of mechanisms to perform synchronization / clock distribution / network timing per CES. The CSM synchronizes all the included IFMs in the node.

The application endpoints in a 'Circuit Emulation: CODIR' service can communicate in a synchronized way. Which method can be used depends on:

- ▶ the 'Clock source' port setting of the two endpoints;
- ▶ the 'Differential Clocking' setting in this service;
- ▶ SyncE availability in the endpoint nodes;

The figures below show relevant end-to-end clocking configurations for this IFM. The PRC (=Primary Reference Clock) is a very stable high quality clock that can be used as a reference clock delivered via SyncE to the node:

- ▶ A, D = Application ports;
- ▶ B, C = IFM front ports;

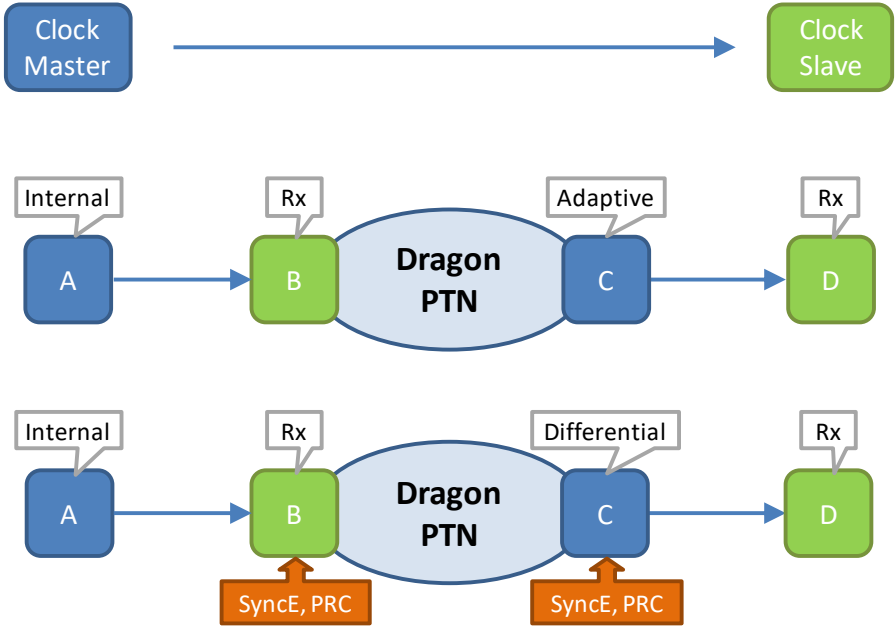

**Figure 14 Clocking: Application D Slaves to Application A via Dragon PTN**

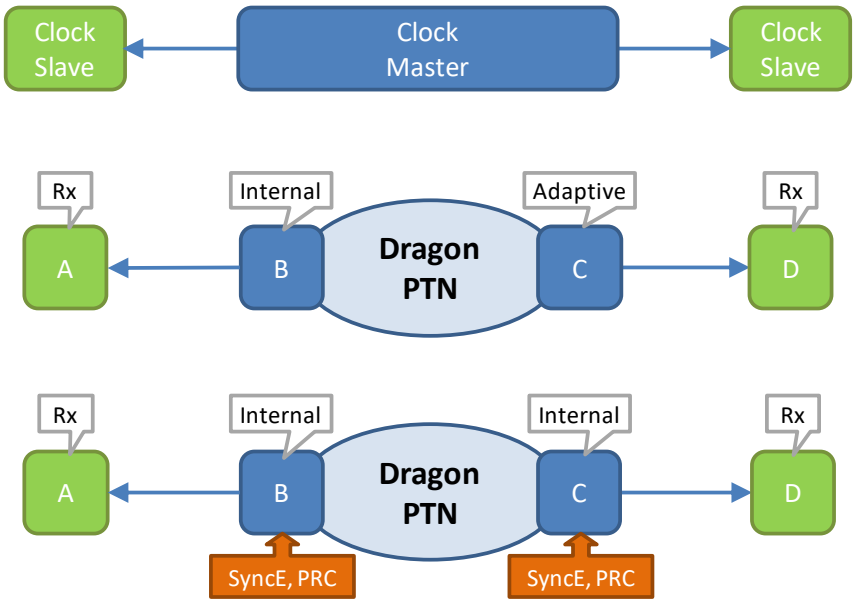

**Figure 15 Clocking: Both Application A and D Slave to Dragon PTN Clock Master**

**Table 7 Clocking Parameters on Port & Service Level**

<b>Port A: Clock Source</b>	<b>Port B: Clock Source</b>	<b>Service: Differential Clocking</b>	<b>Port C: Clock Source</b>	<b>Port D: Clock Source</b>	<b>Description</b>
<b>Application D slaves to application A via Dragon PTN</b>					
'Internal Clock'	'Rx Clock'	Unchecked	'Adaptive/ Differential'	'Rx Clock'	<p>Node (B) recovers the clock from the incoming data stream from Application (A) and uses it to decode/encode the packet stream.</p> <p>Node (C) recovers the clock from the incoming packet stream from the network and uses it to encode/decode the data stream. Application (D) slaves its clock to this stream.</p>
'Internal Clock'	'Rx Clock' + SyncE	Checked	'Adaptive/ Differential' + SyncE	'Rx Clock'	<p>Node (B) recovers the clock from the incoming data stream from Application (A) and uses it to decode/encode the packet stream. Node (B) embeds extra RTP timing information in that packet stream when forwarding it on the Dragon PTN network.</p> <p>Node (C) generates the clock based on the PRC and the embedded RTP timing information in the incoming packet stream. The generated clock is used to encode/decode the data stream. Application (D) slaves its clock to this stream.</p>
<b>Both Applications A and D slave to Dragon PTN Clock Master</b>					
'Rx Clock'	'Internal Clock'	Unchecked	'Adaptive/ Differential'	'Rx Clock'	<p>Node (B) transmits packets to node (C) based on an Internal Clock. This clock is delivered by the local oscillator on the IFM. Node (C) recovers the clock from the incoming packet stream from the network and uses it to encode/decode data streams.</p> <p>Both applications (A) and (D) slave their clock to the data streams delivered by node (B) and (C).</p>
'Rx Clock'	'Internal Clock' + SyncE	Unchecked	'Internal Clock' + SyncE	'Rx Clock'	<p>Both nodes (B) and (C) encode/decode the data stream to/from the end applications based on the 'Internal Clock' on the IFM. This clock is delivered by the CSM and is based on a PRC delivered via SyncE to the node.</p> <p>Both applications (A) and (D) slave their clock to the data streams delivered by node (B) and (C).</p>

**NOTE:** SyncE: See the manuals in See Ref. [2Net] and Ref.[4] in Table 1 for more detailed information;



### 2.2.11 Test and Loopback Selftests

Test and Loopback selftests can be performed in CESs, e.g. when configuring or troubleshooting a CES. Following two functions can be used in a programmed CES:

- ▶ Loopbacks: on backplane or front port, direction towards line (=application) or network can be configured;
- ▶ BERT: test traffic generation and verification via Bit Error Ratio Tester.

**CAUTION: enabling selftests disables or disturbs normal service traffic on a port!**

For more information and configuration settings, see 'Test and Loopback' in Ref.[1] in Table 1.

### 2.3 Onboard Interfaces

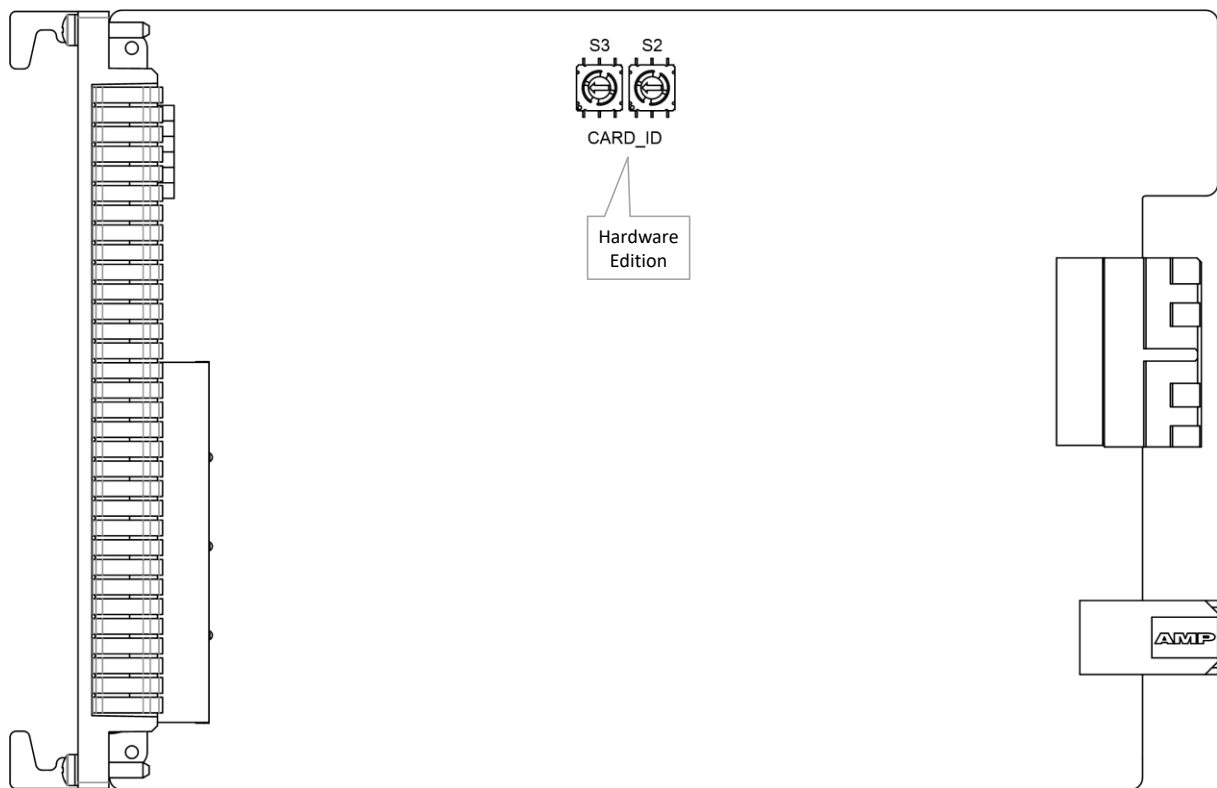

Figure 16 4-CODIR: Side View

#### 2.3.1 Straps

No user relevant straps.

#### 2.3.2 DIP Switches

##### a. Hardware Edition

The Hardware Edition (Figure 16) is set in decimal code using rotary switches S2 to S3 (=most significant). It can be read out as well via HiProvision. This edition has been factory set and **MUST NOT BE CHANGED!** Example: Setting S3='0' and S2='5' indicates Hardware Edition '5' (dec).

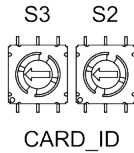

**Figure 17 Hardware Edition**

### 3. TDM FRAMES/PACKET

#### 3.1 General

In a CES service, the amount of TDM Frames per Ethernet packet is an important setting because it influences the amount of consumed bandwidth and delay through the network. The more TDM Frames/Packet, the less bandwidth is used but the bigger the total delay through the network.

In HiProvision, it can be configured how many TDM Frames/Packet can be encoded.

- ▶ Default TDM Frames/Packet = 4;
- ▶ Maximum TDM Frames/Packet, no Hitless Switching: 24;
- ▶ Maximum TDM Frames/Packet, Hitless Switching: 10.

#### 3.2 Bandwidth

If only one TDM frame per packet is encoded, it generates a lot of header information on the network resulting in a lot of consumed bandwidth. Encoding more frames into one packet will decrease the amount of header information and as a result the consumed bandwidth as well. As of 8 frames per packet and higher, the bandwidth consumption stabilizes towards the minimum bandwidth consumption. See the graph below.

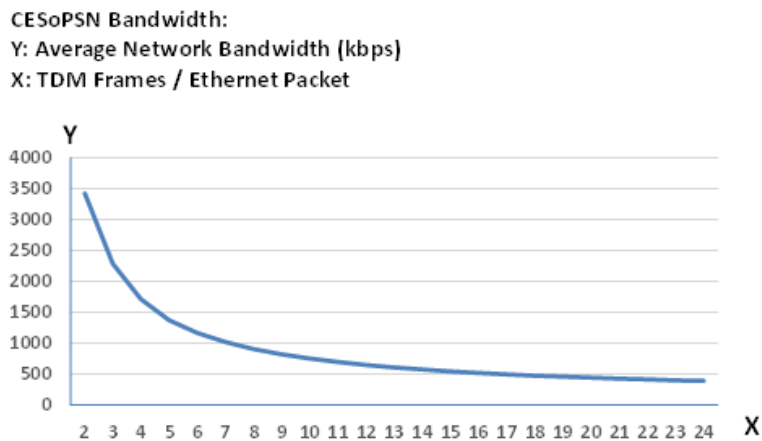

**Figure 18 CESoPSN Bandwidth**

### 3.3 Delay

#### 3.3.1 General

The total delay between two end points over the Dragon PTN network depends on:

- ▶ **P** (=Packetization Delay): Delay to encode 64 kbps input into MPLS-TP packets;

- ▶ **Path Delay:** Delay from source to destination over the MPLS-TP network path; can be measured by HiProvision via OAM delay measurement for the specific service; Path Delay = Delay external network (if any) + 5μs/km + 10μs/node;
- ▶ **DP (=Depacketization Delay):** Delay to decode MPLS-TP packets into 64 kbps output;
- ▶ **DPH:** Extra Depacketizing Delay due to hitless switching;
- ▶ **Total Delay =** Total Network delay between two 64 kbps applications;
- ▶ **Total Delay =** (Packetization + Path + Depacketization + Hitless Switching) Delay;

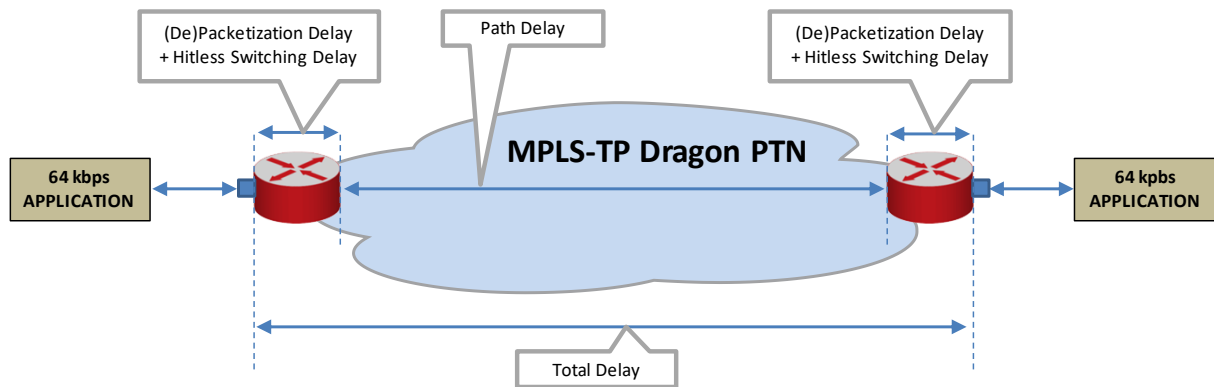

**Figure 19 Delays**

### 3.3.2 Delay Parameters

These delays in §3.3.1 depend on the selected service in HiProvision and its configured delay parameters. HiProvision offers the delay parameters listed below to tune the delay.

**CAUTION: If you are not familiar with these parameters, keep the default values.**

- ▶ **TDM Frames per Packet:** The lower the value, the lower the delay.
- ▶ **Jitter Buffer Size (μs):** advice: Set this value to 'Packetizing Delay + expected peak-to-peak jitter (μs)'; The default peak-to-peak jitter could be 250 μs; The expected peak-to-peak jitter (μs) must be measured in the network. If the packetizing delay 'P' < 2000 μs, set the buffer size to at least 2000 μs. If the packetizing delay 'P' > 2000 μs (e.g. 2500 μs), set the buffer size to at least e.g. 2500 μs.

**CAUTION: By default, the jitter buffer will reset once for optimal processing 15 seconds after a change in the service occurs. This reset will cause a minimal loss of data. See 'jitter buffer' in the Ref. [2Leg] in Table 1 for more information.**

- ▶ **Maximum Network Path Delay Difference (μs)** (only for Hitless Switching): advise: Set this value to '(Two Paths nodes difference)\*10 + expected peak-to-peak jitter(μs)'. If path1 has 17 nodes and path2 has 8 nodes, this is a difference of 9 nodes. You could set MaxNetwPathDelayDiff = 9\*10 + 250 = 340 μs;

### 3.3.3 Estimated Delay Calculation and Formulas

Table 8 shows formulas to calculate an estimated delay. Once you have the desired estimated delay, fill out the parameter values in HiProvision, which shows the calculated 'P+DP+DPH'.

**Table 8 Estimated Delay Formulas**

Delay	No Hitless Switching	Hitless Switching
P	TDMFramesPerPacket * 125	
Path Delay	measured by HiProvision	
DP	$(\text{JitterBufferSize} - P) / 2$	
DPh	0	$2P + \text{MaxNetwPathDelayDiff} + 1087$
Total	$P + \text{Path Delay} + DP + DPh$	

### 3.3.4 Estimated Delay Examples

Find some example values below. Fill them out in the formulas to find the estimated total delay:

- ▶ TDMFramesPerPacket = 10
- ▶ Pathdelay (measured by HiProvision) = 500 μs
- ▶ JitterBufferSize = 4000 μs
- ▶ MaxNetwPathDelayDiff = 340 μs

**Table 9 Estimated Delay (μs) Examples**

Delay	No Hitless Switching	Hitless Switching
P	<u>10</u> * 125 = 1250	
Path Delay	500	
DP	$(\text{4000} - 1250) / 2 = 1375$	
DPh	0	$2 * 1250 + \text{340} + 1087 = 3927$
Total	$1250 + 500 + 1375 + 0 = \text{3125 } \mu\text{s}$	$1250 + 500 + 1375 + 3927 = \text{7052 } \mu\text{s}$

### 3.3.5 Differential Delay

Differential Delay is the difference in Path Delays between two end-points, measured in two opposite directions over the same path.

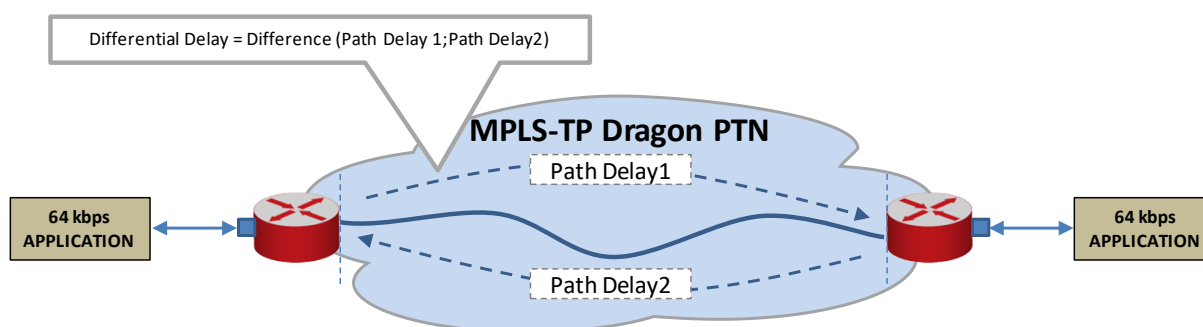

**Figure 20 Differential Delay**

When Differential Delay is very important for your application, we strongly advise to:

- ▶ Not use Hitless Switching with Single Path (§2.2.6), all the other modes are OK;
- ▶ Use SAToP (§2.2.3) when the differential delay must be as low as possible:
  - ▶ Maximum differential delay SAToP: 157 µs;
  - ▶ Maximum differential delay CESoPSN: 1125 µs;

### 3.4 Tuning CES = Tuning TDM Frames/Packet

Tuning the CES is mainly done by tuning the TDM Frames/Packet parameter. Tuning this parameter is a trade-off between bandwidth and delay. The more bandwidth is consumed the less the resulting network delay and vice versa. This tuning is application dependent. Check out whether bandwidth or delay is critical for an application or network. Based on these findings, bandwidth and delay parameters can be tuned.

Some examples according the information in §3.2 and §3.3:

- ▶ if bandwidth is not a problem, and a small delay is wanted → 1-3 TDM frames/packet;
- ▶ if less bandwidth is required and delay is not important → at least 4 TDM frames/packet;
- ▶ if less bandwidth and a small delay are wanted → 5 .. 10 TDM frames/packet.

## 4. MODULE SPECIFICATIONS

### 4.1 General Specifications

For general specifications like temperature, humidity, EMI... see Ref.[6] in Table 1.

### 4.2 Other Specifications

**Table 10 Other Specifications**

Description	Value
Weight	0.27 kg / 0.6 lb
MTBF	96 years at 25°C/77°F
Power Consumption	6 W (measured at 25°C/77°F, with data transport)
Module Size	width: 20.32 mm / 0.8 inches height: 126 mm / 4.96 inches depth: 195 mm / 7.68 inches

### 4.3 Ordering Information

- ▶ PTN-4-CODIR: 942 236-020;
- ▶ Interface Adapter Kit for Core Nodes: 942 237-007.

## 5. ABBREVIATIONS

<b>AIS</b>	Alarm Indication Signal
<b>AMI</b>	Alternate Mark Inversion
<b>BERT</b>	Bit Error Ratio Tester
<b>CE</b>	Conformité Européenne
<b>CES</b>	Circuit Emulation Service
<b>CESoPSN</b>	Circuit Emulation Service over Packet Switched Network
<b>CSM</b>	Central Switching Module
<b>EMI</b>	Electromagnetic Interference
<b>ERR</b>	Error
<b>ETH</b>	Ethernet
<b>FLT</b>	Fault
<b>IEEE</b>	Institute of Electrical and Electronics Engineers
<b>IFM</b>	InterFace Module
<b>kbps</b>	Kilobit per Second
<b>LAN</b>	Local Area Network
<b>LOS</b>	Loss Of Signal
<b>LVD</b>	Low Voltage Directive
<b>Mbps</b>	Megabit per Second
<b>MPLS-TP</b>	MultiProtocol Label Switching – Transport Profile
<b>MTBF</b>	Mean Time Between Failures
<b>OAM</b>	Operations, Administration and Maintenance
<b>PF</b>	Power Failure
<b>PI</b>	Power Input
<b>PTN</b>	Packet Transport Network
<b>PTP</b>	Point to Point
<b>SAToP</b>	Structure Agnostic TDM over Packet
<b>SF</b>	Super Frame
<b>SyncE</b>	Synchronous Ethernet
<b>TDM</b>	Time Division Multiplex
<b>WAN</b>	Wide Area Network