



**HIRSCHMANN**

A **BELDEN** BRAND

# Antenna Guide

## Wireless LAN

### Antennas of the BAT family



The naming of copyrighted trademarks in this manual, even when not specially indicated, should not be taken to mean that these names may be considered as free in the sense of the trademark and tradename protection law and hence that they may be freely used by anyone.

© 2017 Hirschmann Automation and Control GmbH

Manuals and software are protected by copyright. All rights reserved. The copying, reproduction, translation, conversion into any electronic medium or machine scannable form is not permitted, either in whole or in part. An exception is the preparation of a backup copy of the software for your own use.

The performance features described here are binding only if they have been expressly agreed when the contract was made. This document was produced by Hirschmann Automation and Control GmbH according to the best of the company's knowledge. Hirschmann reserves the right to change the contents of this document without prior notice. Hirschmann can give no guarantee in respect of the correctness or accuracy of the information in this document.

Hirschmann can accept no responsibility for damages, resulting from the use of the network components or the associated operating software. In addition, we refer to the conditions of use specified in the license contract.

You can get the latest version of this manual on the Internet at the Hirschmann product site ([www.hirschmann.com](http://www.hirschmann.com)).

Hirschmann Automation and Control GmbH  
Stuttgarter Str. 45-51  
72654 Neckartenzlingen  
Germany

# Contents

	<b>Introduction</b>	<b>5</b>
<b>1</b>	<b>Current BAT portfolio</b>	<b>6</b>
<b>2</b>	<b>Schematic representation for connecting antennas and protectors to the devices</b>	<b>8</b>
<b>3</b>	<b>Antenna Selection Criteria</b>	<b>9</b>
<b>4</b>	<b>External antennas</b>	<b>15</b>
4.1	Legal regulations for operation external antennas	15
4.1.1	Relevant for use in the USA and in Canada:FCC compliant antennas	15
4.1.2	Relevant for use in Japan:	22
4.2	Omni-Directional Antennas	24
4.2.1	Omni-Directional Antenna for 2.4 GHz band	24
4.2.2	Omnidirectional antenna for 5 GHz band	26
4.2.3	Omnidirectional Antenna for 2.4 and 5 GHz band	27
4.2.4	Omni-directional dual-band antennae for MiMo for the 2.4 GHz and 5 GHz bands	33
4.2.5	Dual band Hemispherical Antenna for 2.4 and 5 GHz band	34
4.3	Sector Antennas	36
4.3.1	Polarization-diversity antenna for 2.4 GHz band, linear	36
4.3.2	Polarization-diversity antenna for 5 GHz band, linear	38
4.3.3	Sectoral MiMoantenna for 5 GHz band	40
4.4	Directional Antennas	42
4.4.1	Directional antenna for the 2.4 GHz band with 14 dBi gain	42
4.4.2	Directional antenna for 5 GHz band with 18 dBi gain	46
4.4.3	Directional antenna for 5 GHz band with a gain of 23 dBi	50
4.5	Radiating Cable Antennas (Leaky Cable)	53

4.5.1	Leaky Cable for 2.4 GHz; black	53
<b>5</b>	<b>Cables/Adapter</b>	<b>57</b>
<b>A</b>	<b>Explanation of passive antennas in explosive hazard areas</b>	<b>64</b>
<b>B</b>	<b>Antenna diagrams</b>	<b>65</b>
<b>C</b>	<b>Index</b>	<b>69</b>

# Introduction

Since 2004, Hirschmann Automation and Control GmbH has provided a continually expanding product portfolio relating to WLAN.

Our product portfolio comprises the following integral WLAN network elements:

- ▶ active devices such as access points or clients
- ▶ passive components such as cables, antennas, and overvoltage protectors

With our product portfolio, we focus on a high industrial suitability. In order to improve our products, in particular with regard to vibration resistance, grounding behavior, impermeability and emission behavior, we have further developed our antenna portfolio.

You benefit from the following modifications of our antenna portfolio:

- ▶ All antennas comply with the IP65 degree of protection for a high industrial suitability. The sole exception to this is the BAT-ANT-N-14G-IP23 antenna.
- ▶ The emission behavior of the new antennas is more homogeneous, with improved transmit and receive power during operation.
- ▶ The new antennas, equipped with N sockets, allow you to connect the antennas easily and quickly with other cables and overvoltage protectors.
- ▶ The scope of delivery comprises a complete solution, with an antenna, 3.28 ft (1 m) cable and pigtail included. The complete solution allows you to immediately connect the antenna to the following devices:  
BAT-C, BAT-F, BAT-R, BAT300-Rail, BAT450-F, BAT867-R
- ▶ You obtain every antenna with vibration resistant, weatherproof, and sturdy mounting material.

We continually improve our product portfolio and include WLAN technology innovations in our portfolio. As a result, our portfolio is subject to short term changes. Check regularly for updates of our portfolio by visiting the Hirschmann product pages ([www.hirschmann.com](http://www.hirschmann.com)).

# 1 Current BAT portfolio

Device	Supported standards	Maximum gross data rate
BAT-C	IEEE 802.11a/b/g/h/n	65 MBit/s
BAT867-R	IEEE 802.11a/b/g/n/ac	867 MBit/s (2x MIMO)
BAT300 family	IEEE 802.11a/b/g/h/n	300 MBit/s (2x MIMO)
BAT450-F	IEEE 802.11a/b/g/h/n	450 MBit/s (3x MIMO)
OpenBAT family	IEEE 802.11a/b/g/h/n	450 MBit/s (3x MIMO)

Table 1: Current BAT portfolio

BAT-C	BAT867-R	BAT300 family BAT300-Rail	BAT300 family BAT300-F	BAT450-F	OpenBAT family BAT-F BAT-R
<p>The devices are supplied with an IP67 aluminum housing. They are suitable for use in an industrial environment.</p>	<p>The devices are supplied in metal casings that can be mounted on DIN rails of automation technology.</p>	<p>The devices are supplied in metal enclosures for mounting on DIN rails in automation or vehicle applications.</p>	<p>The devices are supplied in IP65/67 metal housings. They are designed for field-level applications or harsh industrial environments.</p>	<p>Industrial WLAN Access Points with different interfaces for connections using WLAN, WWAN (Wireless Wide Area Network, for example LTE) and Ethernet.</p>	<p>The devices are supplied in a metal housing that can be fastened to DIN rails using automation technology. They provide impressive flexibility and high speeds.</p>

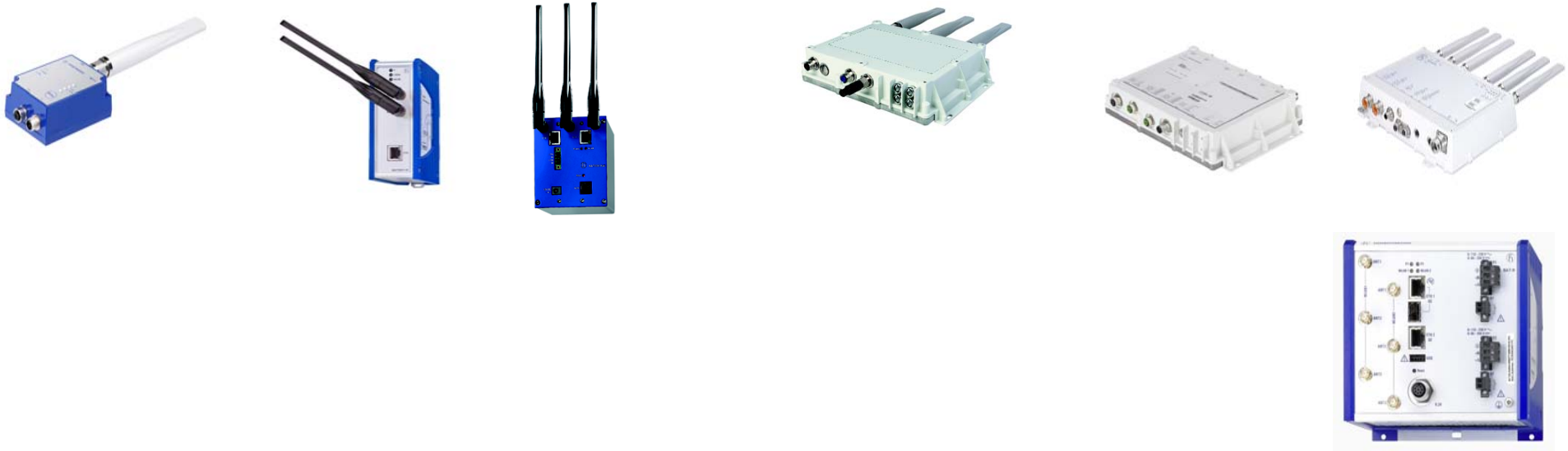
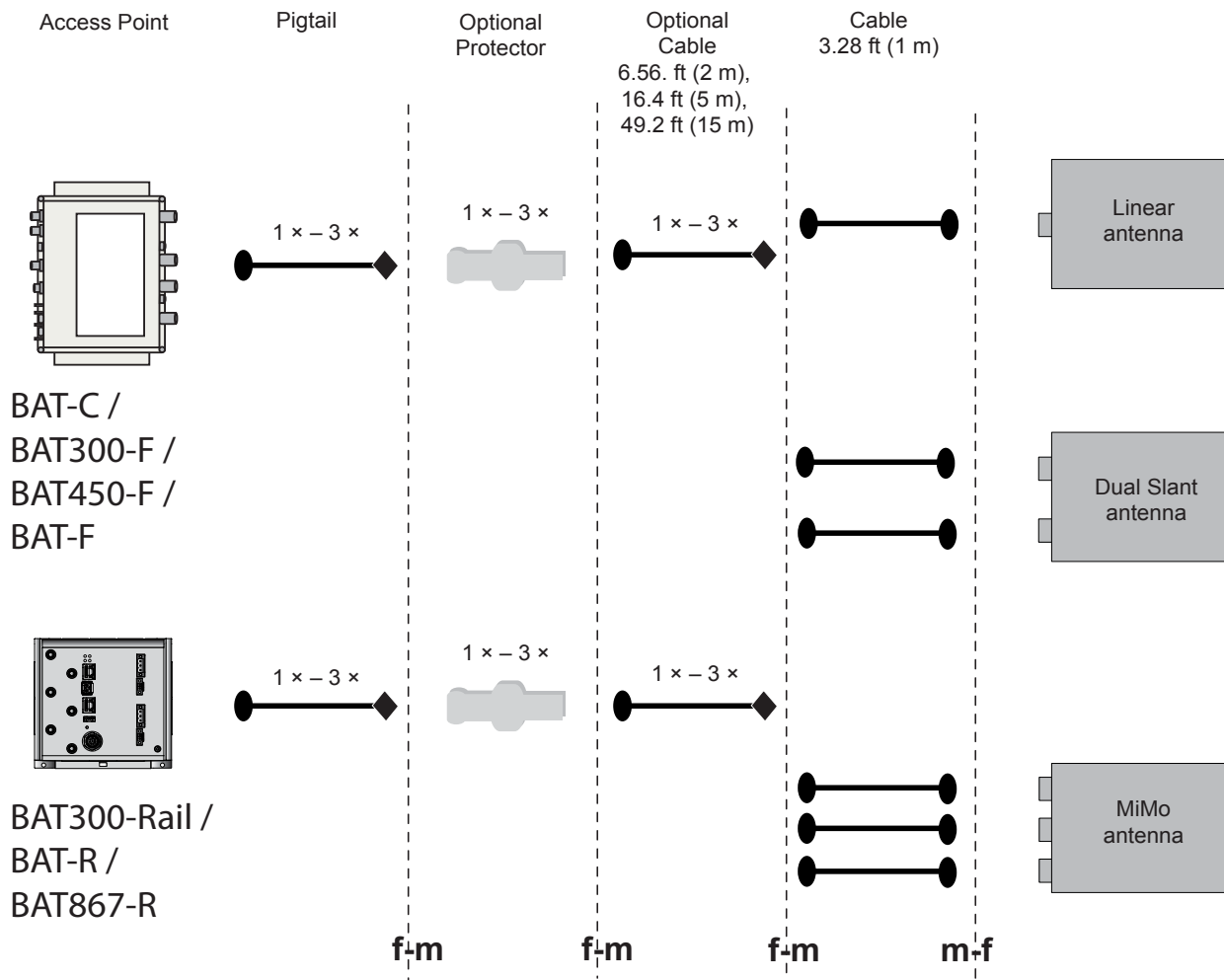

Table 2: BAT-Family: Overview

For further information, see the "User Manual Installation" for the corresponding device.

## 2 Schematic representation for connecting antennas and protectors to the devices



The provided accessories listed in the antenna description provides you with the following options:

- ▶ 3.28 ft (1 m ) cable with N plugs at both ends: connection of the antenna with this cable
- ▶ Pigtail, R-SMA plug to N socket: connection of the antenna to devices with R-SMA socket

**Note:** The BAT Protector can be screwed onto the BAT-C / BAT300-F / BAT450-F / BAT-F directly, or be connected between two cables, as it is equipped with a plug and a socket.



### 3 Antenna Selection Criteria

- Take into account the national regulations that apply to the operation of antennas before considering any other criteria.

[See “Legal regulations for operation external antennas” on page 15.](#)

**Note:** Hirschmann recommends that you perform an on-site inspection and an analysis to prepare for the installation of a WLAN.





Typical antenna ranges, based on the frequency range and the antenna type:

- ▶ Frequency range: 2.4 GHz
  - Short range: up to 218 yards (200 m) with omnidirectional antennas.
  - Medium range: up to 0.62 miles (1 km) with sector antennas.
  - Long range: up to 3.11 miles (5 km) with directional antennas.
- ▶ Frequency range: 5 GHz
  - Short range: up to 328 yards (300 m) with omnidirectional antennas.
  - Medium range: up to 1.86 miles (3 km) with sector antennas.
  - Long range: up to 9.32 miles (15 km) with directional antennas.

The typical ranges provide orientation for the first-time antenna selection.

The actual antenna range depends on several factors such as output power, line of sight, and interference.

In the following table you find antenna descriptions. Together with the above described typical ranges, the descriptions provide orientation for the first-time antenna selection.

Art.-No	Antenna	Product Image	Description	BAT-C	BAT867-R	BAT300 family		BAT450-F		OpenBAT family	
						BAT300-Rail	BAT300-F	non-LTE	LTE	BAT-R	BAT-F
943 981-022	BAT-ANT-N-6G-IP65		Omnidirectional antenna for 2.4 GHz band	+++	+	+	+	+	+	+	+
943 981-003	BAT-ANT-N-5A-IP65		Omnidirectional antenna for 5 GHz band	+++	+	+	+	+	+	+	+
942 110-001	BAT-ANT-N-3AGN-IP67		Omnidirectional antenna for 2.4 GHz band and 5 GHz band	+++	-	-	+	+	-	-	+
942 047-001	BAT-ANT-N-3AGN-F		Omnidirectional antenna for 2.4 GHz band and 5 GHz band	+++	-	-	+	+	+	-	+

**Table 3:** +++ very good; ++ good; + possible; – cannot be used; nr = not relevant  
Whether an antenna is actually suitable depends on the application case.





Art.-No	Antenna	Product Image	Description	BAT-C	BAT867-R	BAT300 family		BAT450-F		OpenBAT family	
						BAT300-Rail	BAT300-F	non-LTE	LTE	BAT-R	BAT-F
942 046-001	BAT-ANT-RSMA-2AGN-R		Omnidirectional antenna for 2.4 GHz band and 5 GHz band	-	+	+	-	-	-	+	-
943 981-004	BAT-ANT-N-6ABG-IP65		Hemispherical antenna for 2.4 GHz band and 5 GHz band	+++	+	+	+	+	+	+	+
943 981-005	BAT-ANT-N-14G-IP23		Directional antenna for 2.4 GHz band with 14 dBi gain	-	-	+	+	+	+	+	+
943 981-006	BAT-ANT-N-18A-V-IP65		Directional antenna for 5 GHz band with 18 dBi gain	-	-	+	+	+	+	+	+
943 981-007	BAT-ANT-N-23A-V-IP65		Directional antenna for 5 GHz band with a high gain of 23 dBi	-	-	+	+	+	+	+	+

Table 3: +++ very good; ++ good; + possible; – cannot be used; nr = not relevant  
Whether an antenna is actually suitable depends on the application case.







Art.-No	Antenna	Product Image	Description	BAT-C	BAT867-R	BAT300 family		BAT450-F		OpenBAT family	
						BAT300-Rail	BAT300-F	non-LTE	LTE	BAT-R	BAT-F
943 981-008	BAT-ANT-N-23A-VH-IP65		Directional antenna for 5 GHz band with a high gain of 23 dBi	-	-	+++	+++	+++	+++	+++	+++
943 981-014	BAT-ANT-N-MiMo5-18N-IP65		Directional antenna for 5 GHz band with 18 dBi gain	-	-	+++	+++	+++	+++	+++	+++
943 981-009	BAT-ANT-N-8G-DS-IP65		Polarization-diversity antenna for 2.4 GHz band, linear	-	-	++	++	++	++	++	++
943 981-010	BAT-ANT-N-9A-DS-IP65		Polarization-diversity antenna for 5 GHz band, linear	-	-	++	++	++	++	++	++
943 981-012	BAT-ANT-N-MiMoDB-5N-IP65		Omni-directional dual-band antenna for MiMo for the 2.4 GHz and 5 GHz bands	-	+	-	+++	+++	+++	+++	+++
943 981-013	BAT-ANT-N-MiMo5-9N-IP65		Sectoral MiMoantenna for 5 GHz band	-	-	+++	+++	+++	+++	+++	+++

Table 3: +++ very good; ++ good; + possible; – cannot be used; nr = not relevant  
Whether an antenna is actually suitable depends on the application case.









Art.-No	Antenna	Product Image	Description	BAT-C	BAT867-R	BAT300 family		BAT450-F		OpenBAT family	
						BAT300-Rail	BAT300-F	non-LTE	LTE	BAT-R	BAT-F
943 981-001	BAT-ANT-N-LC-G-50m-IP65		Leaky wave conductor for 2.4 GHz, black, 50m	+++	+++	+++	+++	+++	+++	+++	+++
943 981-101	BAT-ANT-N-LC-G-100m-IP65		Leaky wave conductor for 2.4 GHz, black, 100m	+++	+++	+++	+++	+++	+++	+++	+++
943 903-373	BAT-ANT-Protector m-f		Overvoltage Protector	+++	+++	+++	+++	+++	+++	+++	+++
943 903-374	BAT-LAN-Protector IP68		Surge Arrestor LAN/PoE	+++	+++	+++	+++	+++	+++	+++	+++
943 903-360	BAT-Pigtail		Adapter cable (N socket/RP-SMA plug)	nr	+++	+++	-	-	-	+++	-
943 903-514	BAT-CLB-2 N m-f		Antenna Cable N-Plug to N-Jack 2 m (6.56 ft)	+++	+++	+++	+++	+++	+++	+++	+++

Table 3: +++ very good; ++ good; + possible; – cannot be used; nr = not relevant  
Whether an antenna is actually suitable depends on the application case.

Art.-No	Antenna	Product Image	Description	BAT-C	BAT867-R	BAT300 family		BAT450-F		OpenBAT family	
						BAT300-Rail	BAT300-F	non-LTE	LTE	BAT-R	BAT-F
943 903-516	BAT-CLB-5 N m-f		Antenna Cable N-Plug to N-Jack 5 m (16.40 ft)	+++	+++	+++	+++	+++	+++	+++	+++
943 903-515	BAT-CLB-15 N m-f		Antenna Cable N-Plug to N-Jack 15 m (49.21 ft)	+++	+++	+++	+++	+++	+++	+++	+++

*Table 3: +++ very good; ++ good; + possible; – cannot be used; nr = not relevant  
Whether an antenna is actually suitable depends on the application case.*

## 4 External antennas

This chapter is structured as follows:

- ▶ “Legal regulations for operation external antennas” on page 15
- ▶ “Omni-Directional Antennas” on page 24
- ▶ “Sector Antennas” on page 36
- ▶ “Directional Antennas” on page 42
- ▶ “Radiating Cable Antennas (Leaky Cable)” on page 53

### 4.1 Legal regulations for operation external antennas

You find additional information on approvals, certifications, and self-declarations in the Installation user manuals for the devices.

- Before operating the antennas, refer to the “Safety instructions” chapter in the “User Manual Installation” for your device or devices.

#### 4.1.1 Relevant for use in the USA and in Canada: FCC compliant antennas



##### ■ OpenBAT, BAT450-F

For the operation of the OpenBAT and BAT450-F devices in the USA and in Canada (characteristic value US for country approval) you require a permit for the operation of antennas. If the operation of a specific antenna is legal depends on the frequency band and the WLAN module used. The following tables provide you an overview of the approved antennas.

Art.-No	Antennas operating with this device model:	Product Image	Description	Permitted band of operation		
				2.4 GHz band	5.15 GHz ... 5.25 GHz band	5.725 GHz ... 5.825 GHz band
942 046-001	BAT-ANT-RSMA-2AGN-R		Omnidirectional antenna for 2.4 GHz band and 5 GHz band	Yes	Yes	Yes
942 110-001	BAT-ANT-N-3AGN-IP67		Omnidirectional antenna for 2.4 GHz band and 5 GHz band	Yes	Yes	Yes
943 981-012	BAT-ANT-N-MiMoDB-5N-IP65		Omni-directional dual-band antenna for MiMo for the 2.4 GHz and 5 GHz bands	Yes	Yes	Yes





**Table 4:** *This table applies exclusively to OpenBAT and BAT450-F devices that are labeled as follows:  
Contains Transmitter Module  
FCC ID: U99EWLAN1  
IC: 4019A-EWLAN1*





Art.-No	Antennas operating with this device model:	Product Image	Description	Permitted band of operation		
				2.4 GHz band	5.15 GHz ... 5.25 GHz band	5.725 GHz ... 5.825 GHz band
943 981-013	BAT-ANT-N-MiMo5-9N-IP65		Sectoral MiMoantenna for 5 GHz band	No	Yes	Yes
943 981-009	BAT-ANT-N-8G-DS-IP65		Polarization-diversity antenna for 2.4 GHz band, linear	Yes	No	No

*Table 4: This table applies exclusively to OpenBAT and BAT450-F devices that are labeled as follows:  
Contains Transmitter Module  
FCC ID: U99EWLAN1  
IC: 4019A-EWLAN1*

The FCC approval is valid only in conjunction with the listed antennas. If other antennas are used, the approval expires. The responsibility lies with the operator of the system. The required antenna impedance is 50 Ω.

Art.-No	Antennas operating with this device model:	Product Image	Description	Permitted band of operation		
				2.4 GHz band	5.15 GHz ... 5.25 GHz band	5.725 GHz ... 5.825 GHz band
942 046-001	BAT-ANT-RSMA-2AGN-R		Omnidirectional antenna for 2.4 GHz band and 5 GHz band	Yes	Yes	Yes
942 110-001	BAT-ANT-N-3AGN-IP67		Omnidirectional antenna for 2.4 GHz band and 5 GHz band	Yes	Yes	Yes
943 981-012	BAT-ANT-N-MiMoDB-5N-IP65		Omni-directional dual-band antenna for MiMo for the 2.4 GHz and 5 GHz bands	Yes	Yes	Yes
943 981-013	BAT-ANT-N-MiMo5-9N-IP65		Sectoral MiMoantenna for 5 GHz band	No	Yes	Yes

**Table 5:** *This table applies exclusively to OpenBAT and BAT450-F devices that are labeled as follows:  
Contains Transmitter Module  
FCC ID: U99EWLAN2  
IC: 4019A-EWLAN2*



Art.-No	Antennas operating with this device model:	Product Image	Description	Permitted band of operation		
				2.4 GHz band	5.15 GHz ... 5.25 GHz band	5.725 GHz ... 5.825 GHz band
943 981-009	BAT-ANT-N-8G-DS-IP65		Polarization-diversity antenna for 2.4 GHz band, linear	Yes	No	No
943 981-014	BAT-ANT-N-MiMo5-18N-IP65		Directional antenna for 5 GHz band with 18 dBi gain	No	No	Yes

*Table 5: This table applies exclusively to OpenBAT and BAT450-F devices that are labeled as follows:  
Contains Transmitter Module  
FCC ID: U99EWLAN2  
IC: 4019A-EWLAN2*

The FCC approval is valid only in conjunction with the listed antennas. If other antennas are used, the approval expires. The responsibility lies with the operator of the system. The required antenna impedance is 50 Ω.

## ■ **BAT867-R**

For the operation of the BAT867-R devices in the USA and in Canada (characteristic value US for country approval) you require a permit for the operation of antennas. If the operation of a specific antenna is legal depends on the frequency band and the WLAN module used. The following table provides you an overview of the approved antennas.

Art.-No	Antennas operating with this device model:	Product Image	Description	Permitted band of operation				
				2.4 GHz band	5 GHz band			
					5180 ... 5240 MHz	5260 ... 5320 MHz	5500 ... 5720 MHz	5745 ... 5825 MHz
942 046-001	BAT-ANT-RSMA-2AGN-R		Omnidirectional antenna for 2.4 GHz band and 5 GHz band	Yes	Yes	Yes	Yes	Yes
943 981-012	BAT-ANT-N-MiMoDB-5N-IP65		Omni-directional dual-band antenna for MiMo for the 2.4 GHz and 5 GHz bands	Yes	Yes	Yes	Yes	Yes







**Table 6:** *This table applies exclusively to BAT867-R devices that are labeled as follows:  
Contains Transmitter Module  
FCC ID: TK4WLE600VX  
IC: 7849A-WLE600VX*



The FCC approval is valid only in conjunction with the listed antennas. If other antennas are used, the approval expires. The responsibility lies with the operator of the system. The required antenna impedance is 50 Ω.

### 4.1.2 Relevant for use in Japan:

The following table applies to OpenBAT variants with the characteristic value JP (Japan) that are labeled as follows:

- ▶ "Contains MIC ID: 204-310014"
- ▶ „5GHz band: この製品は屋内においてのみ使用可能です“

Art.-No	Antennas operating with this device model:	Product Image	Description	Permitted band of operation	
				2.4 GHz band	5 GHz band
942 110-001	BAT-ANT-N-3AGN-IP67		Omnidirectional antenna for 2.4 GHz band and 5 GHz band	Yes	Yes
942 046-001	BAT-ANT-RSMA-2AGN-R		Omnidirectional antenna for 2.4 GHz band and 5 GHz band	Yes	Yes
943 981-004	BAT-ANT-N-6ABG-IP65		Hemispherical antenna for 2.4 GHz band and 5 GHz band	Yes	Yes
943 981-012	BAT-ANT-N-MiMoDB-5N-IP65		Omni-directional dual-band antenna for MiMo for the 2.4 GHz and 5 GHz bands	Yes	Yes
943 981-009	BAT-ANT-N-8G-DS-IP65		Polarization-diversity antenna for 2.4 GHz band, linear	Yes	No
943 981-010	BAT-ANT-N-9A-DS-IP65		Polarization-diversity antenna for 5 GHz band, linear	No	Yes
943 981-022	BAT-ANT-N-6G-IP65		Omnidirectional antenna for 2.4 GHz band	Yes	No

Art.-No	Antennas operating with this device model:	Product Image	Description	Permitted band of operation	
				2.4 GHz band	5 GHz band
943 981-003	BAT-ANT-N-5A-IP65		Omnidirectional antenna for 5 GHz band	No	Yes
943 981-013	BAT-ANT-N-MiMo5-9N-IP65		Sectoral MiMo antenna for 5 GHz band	No	Yes

Using antennas that are not on this list is prohibited. The 5 GHz band is restricted to indoor usage.

## 4.2 Omni-Directional Antennas

### 4.2.1 Omni-Directional Antenna for 2.4 GHz band

#### ■ **BAT-ANT-N-6G-IP65**

Order number: 943 981-022

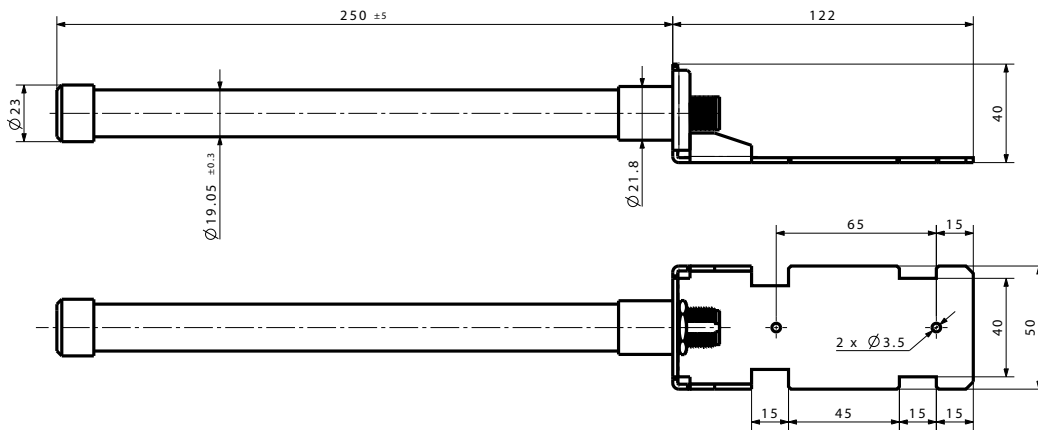



## Radiation Pattern

horizontal 2400 MHz

vertical 2400 MHz

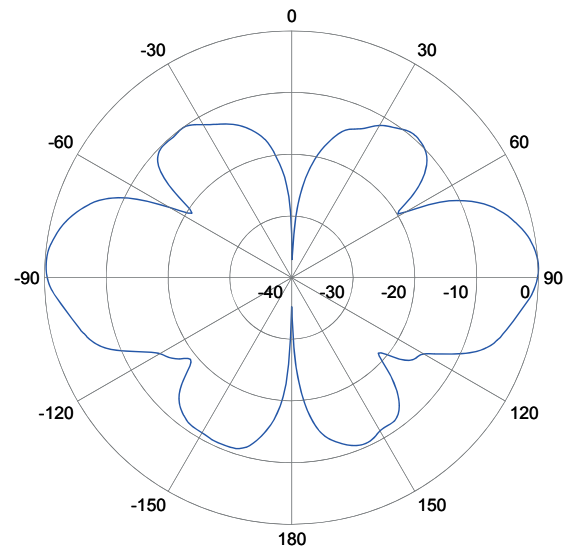
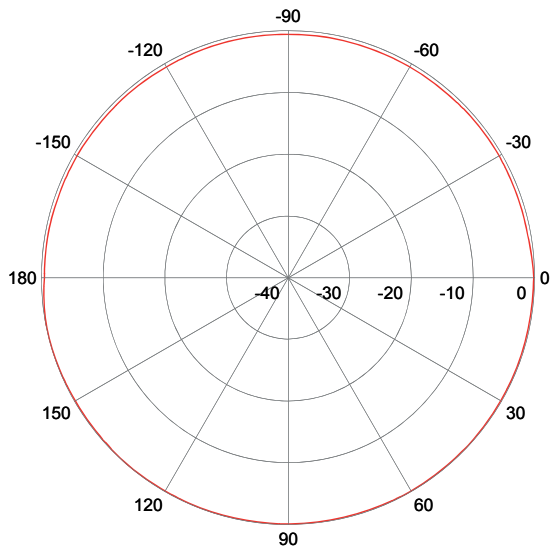

Frequency range	2400 MHz ... 2500 MHz
Gain	6.0 dBi
VSWR (voltage standing wave ratio)	< 1.8
Polarization	Linear, vertical
HPBW (half power bandwidth)	horizontal 360°
Downtilt	0°
Max. Power	25 W
Impedance	50 Ω
Connector	N female

**Table 7: Electrical Specification**

Operating temperature	-40 °F ... +185 °F (-40 °C ... +85 °C)
Storage temperature	-67 °F ... +185 °F (-55 °C ... +85 °C)
Radome color	RAL 9003
Radome material	Fiber glass
Weight	0.75 lb (0.34 kg)
Dimensions	ø 0.87 in × 9.84 in (ø 22 mm × 250 mm)
Protection class	IP67
Flammability	UL 94-HB

**Table 8: Environmental & Mechanical Characteristics**

3.28 ft (1 m) with N plugs at both ends.

Pigtail, R-SMA male to N female

Mounting material

**Table 9: Cable and Accessories**

## 4.2.2 Omnidirectional antenna for 5 GHz band

### ■ **BAT-ANT-N-5A-IP65**

Order Number: 943 981-003



#### Radiation Pattern

horizontal 5470 MHz

vertical 5470 MHz

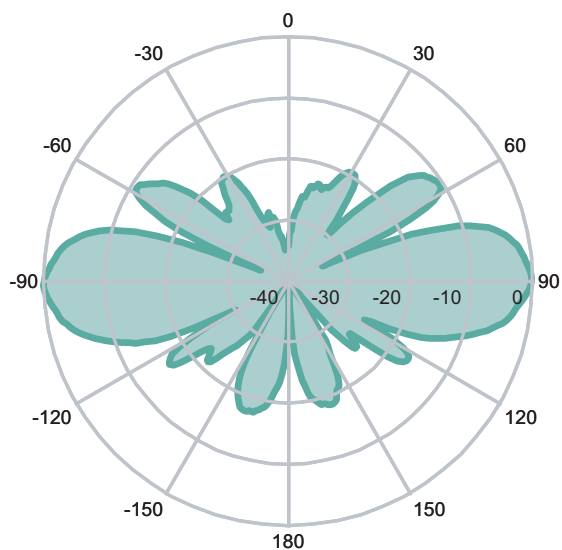
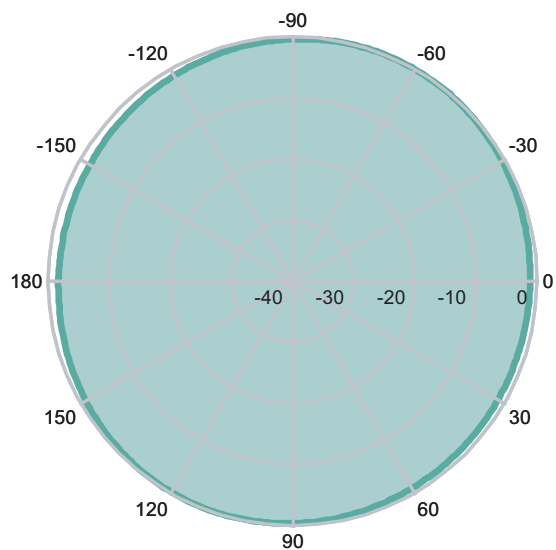

Frequency range	5150 MHz ... 5875 MHz
Gain	5 dBi
VSWR (voltage standing wave ratio)	1.5
Polarization	Linear, vertical
HPBW (half power bandwidth)	horizontal 360°
HPBW (half power bandwidth)	vertical 25°
Max. Power	6 W
Impedance	50 Ω
Connector	N female

Table 10: Electrical Specification

Temperature	-49 °F ... +158 °F (-45 °C ... +70 °C)
Radome color	Grey-white
Radome material	Polypropylene
Weight	0.66 lb (0.3 kg)
Dimensions	0.63 in. × 6.30 in. (16 mm × 160 mm)
Protection class	IP65

*Table 11: Environmental & Mechanical Characteristics*

3.28 ft (1 m) with N plugs at both ends.
Pigtail, R-SMA male to N female
Mounting material

*Table 12: Cable and Accessories*

### 4.2.3 Omnidirectional Antenna for 2.4 and 5 GHz band

#### ■ **BAT-ANT-N-3AGN-IP67**

Order number: 942 110-001 (10 pcs.)

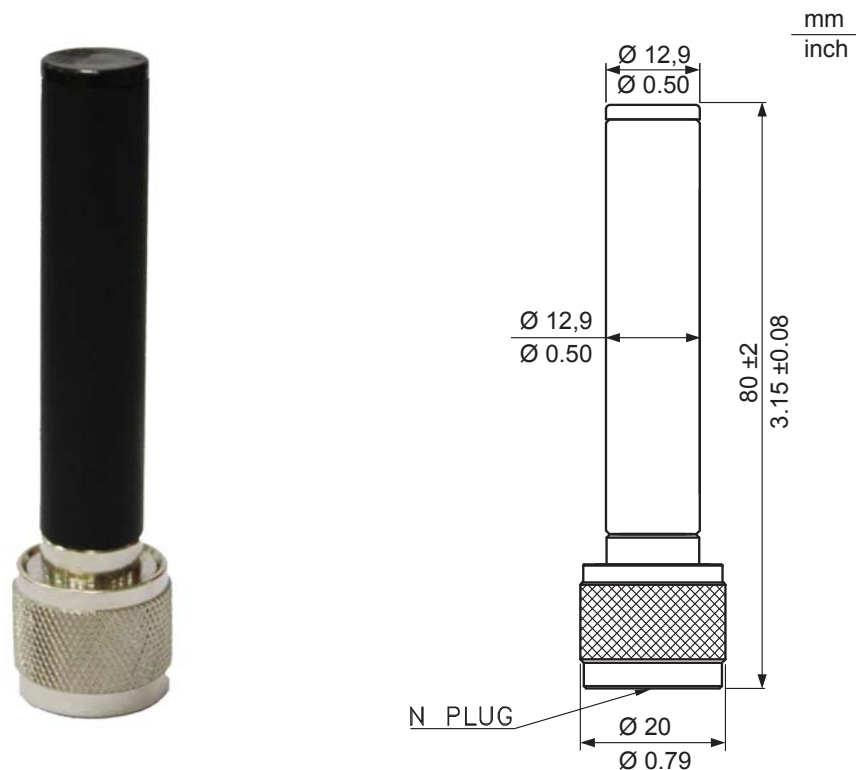

Radiation Pattern	
horizontal	horizontal
2.4 GHz	5 GHz

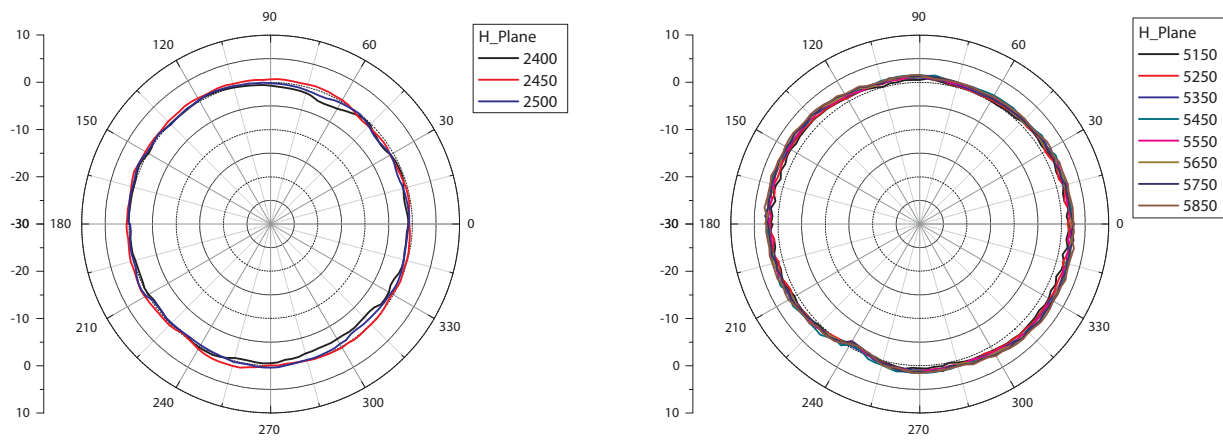

vertical  
2.4 GHz

vertical  
5 GHz

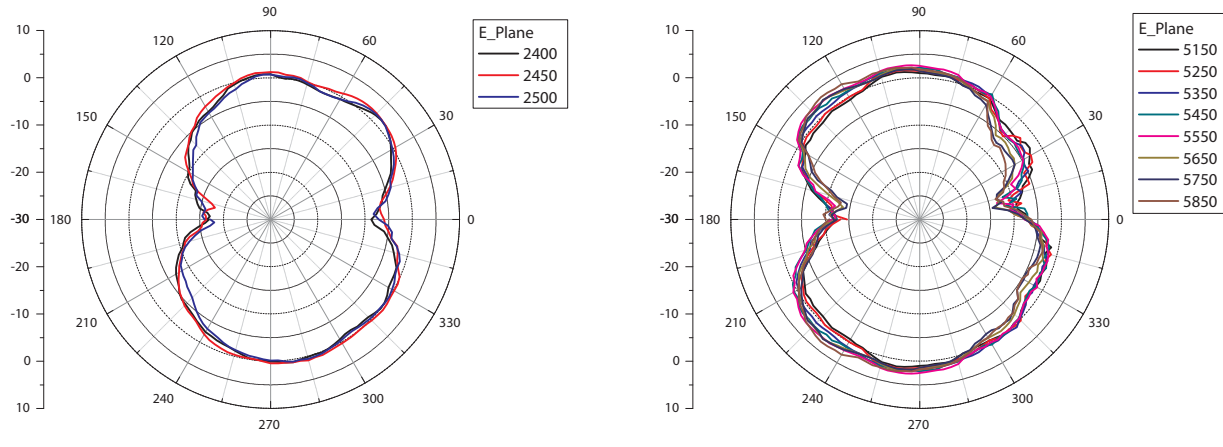

Frequency range	2400 MHz ... 2485 MHz	5150 MHz ... 5850 MHz
Gain	2.0 dBi	2.0 dBi
VSWR (voltage standing wave ratio)	≤ 2.0	
Polarization	Linear, vertical	
HPBW (half power bandwidth)	horizontal 360°	
HPBW (half power bandwidth)	vertical 30°	vertical 15°
Max. Power	2.0 W	
Impedance	50 Ω	
Connector	N-type male	

Table 13: Electrical Specification

Temperature	-40 °F ... +185 °F (-40 °C ... +85 °C)
Radome color	Black
Radome material	PC
Weight	1.23 oz (35 g)
Dimensions	0.79 in. × 3.15 in. (20 mm × 80 mm)
Protection class	IP65 / IP67

Table 14: Environmental & Mechanical Characteristics

## ■ **BAT-ANT-N-3AGN-F**

Order Number: 942 047-001 (10 pcs.)

The antenna is supplied with all BAT-F and BAT-C devices.

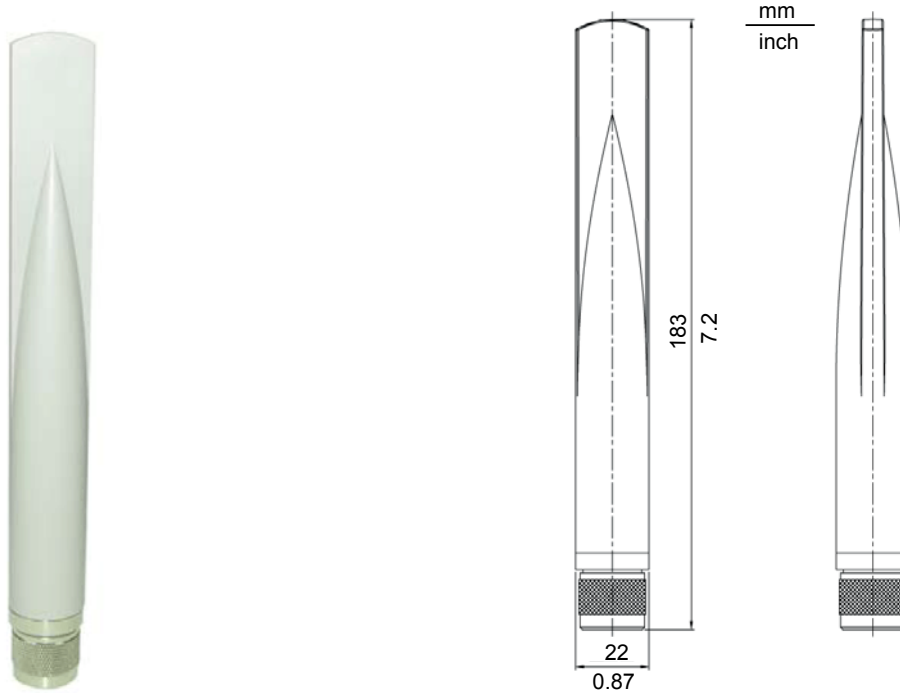

The antenna is directly screwed on the BAT.

### Radiation Pattern

horizontal 2400 MHz

horizontal 5000 MHz

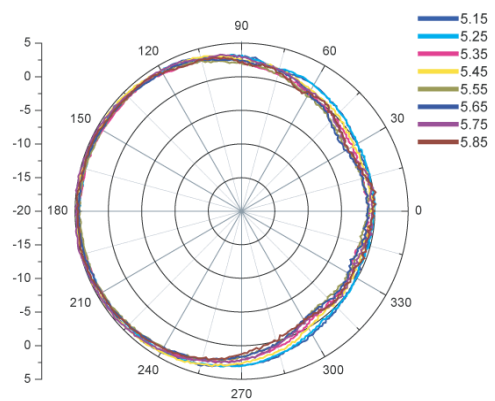
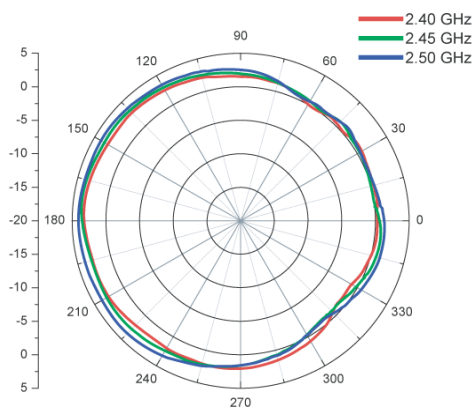

## vertical 2400 MHz

## vertical 5000 MHz

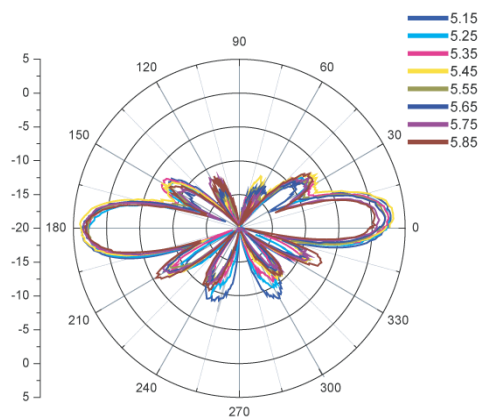
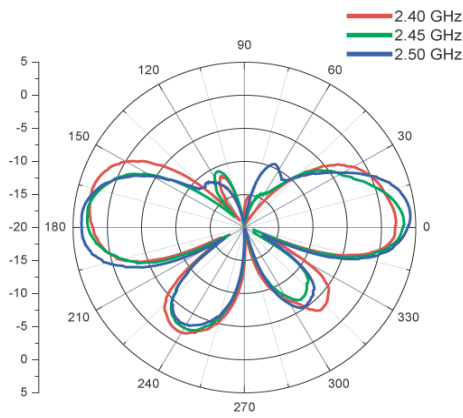

Frequency range	2400 MHz - 2500 MHz	5150 MHz ... 5875 MHz
Gain	2.5 dBi	5.0 dBi
VSWR (voltage standing wave ratio)	2.0	
Polarization	Linear, vertical	
HPBW (half power bandwidth)	horizontal 360°	
HPBW (half power bandwidth)	vertical 30°	vertical 15°
Max. Power	2.0 W	
Impedance	50 Ω	
Connector	N-type male	

**Table 15: Electrical Specification**

Temperature	-40 °F ... +158 °F (-40 °C ... +70 °C)
Radome color	Grey-white
Radome material	ABS
Weight	2.47 oz (70 g)
Dimensions	22 mm x 183 mm (0.87 in x 7.20 in)
Protection class	IP65

**Table 16: Environmental & Mechanical Characteristics**

# BAT-ANT-RSMA-2AGN-R

Order Number: 942 046-001 (10 pcs.)

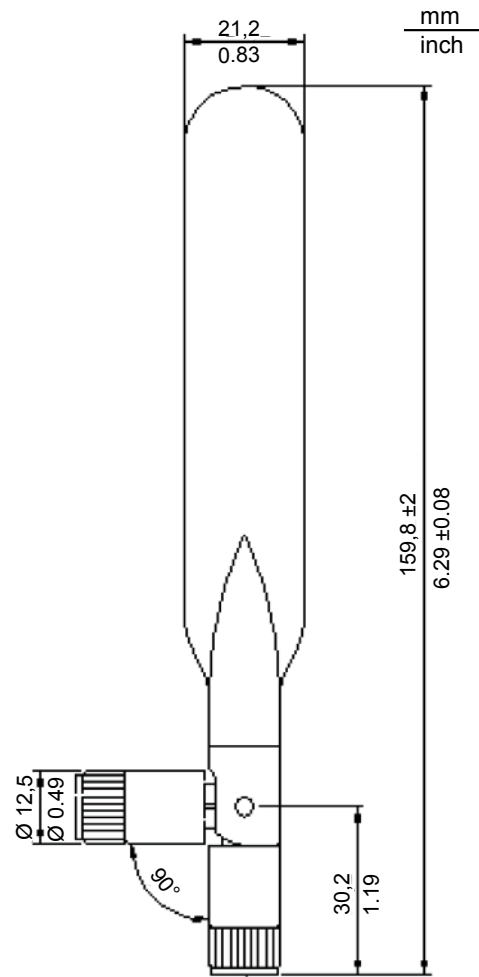

## Radiation Pattern

horizontal 2450 MHz

vertical 2450 MHz

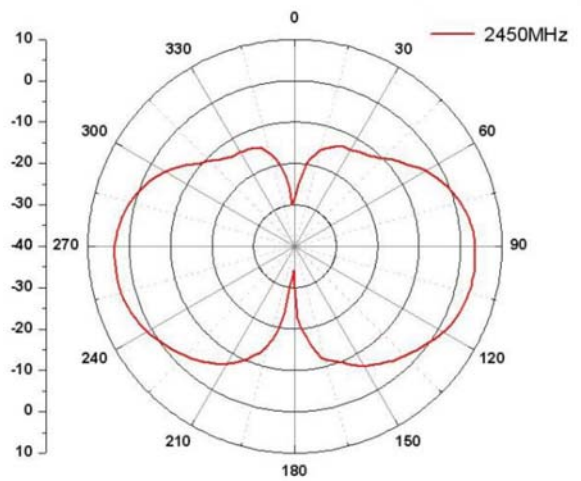
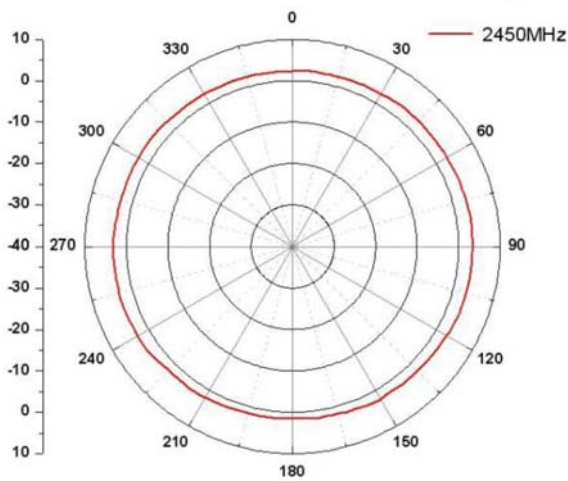

horizontal 5250 MHz

vertical 5250 MHz

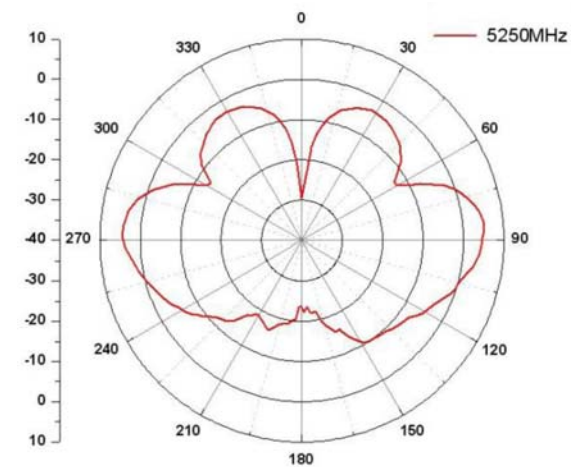
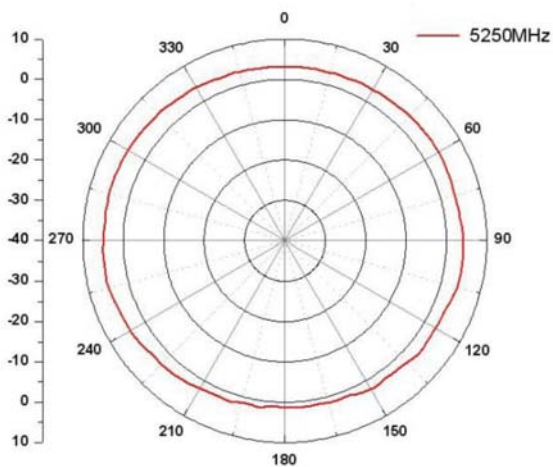

horizontal 5750 MHz

vertical 5750 MHz

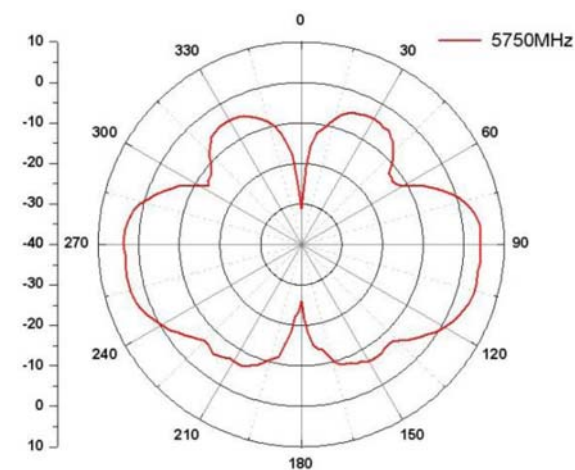
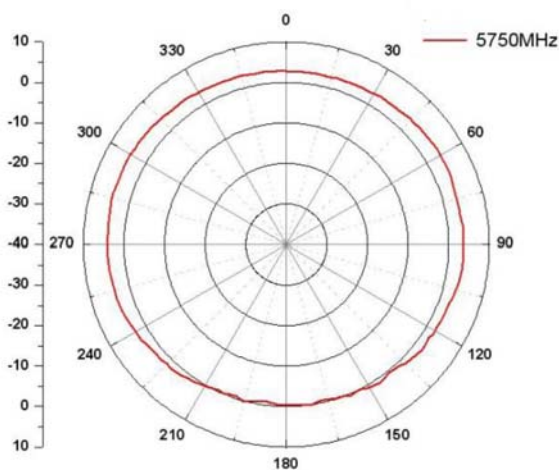

Frequency range	2400 MHz	5250 MHz and 5750 MHz
Gain	3 dBi	5 dBi
VSWR (voltage standing wave ratio)	2.0	
Polarization	Linear, vertical	
HPBW (half power bandwidth)	horizontal 360°	
HPBW (half power bandwidth)	vertical 30°	vertical 15°
Impedance	50 Ω	
Connector	Reverse-SMA male	

Table 17: Electrical Specification

Temperature	-4 °F ... +149 °F (-20 °C ... +65 °C)
Radome color	Black
Radome material	PC/PU
Weight	0.92 oz (26 g)
Dimensions	0.83 in × 6.3 in (21 mm × 160 mm)

Table 18: Environmental & Mechanical Characteristics



## 4.2.4 Omni-directional dual-band antennae for MiMo for the 2.4 GHz and 5 GHz bands

### ■ BAT-ANT-N-MiMoDB-5N-IP65

Order Number: 943 981-012



#### Radiation Pattern

horizontal 2400 MHz

vertical 2400 MHz

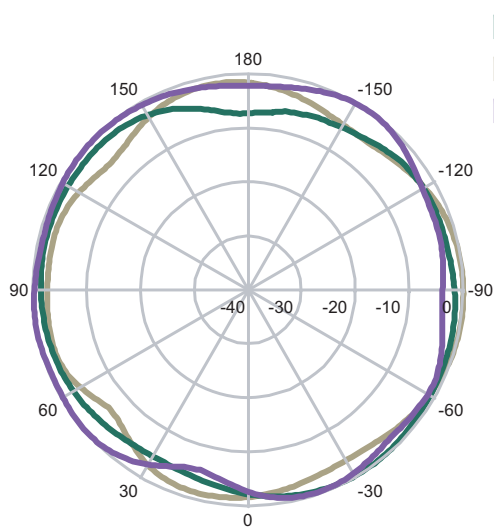

port 1  
port 2  
port 3

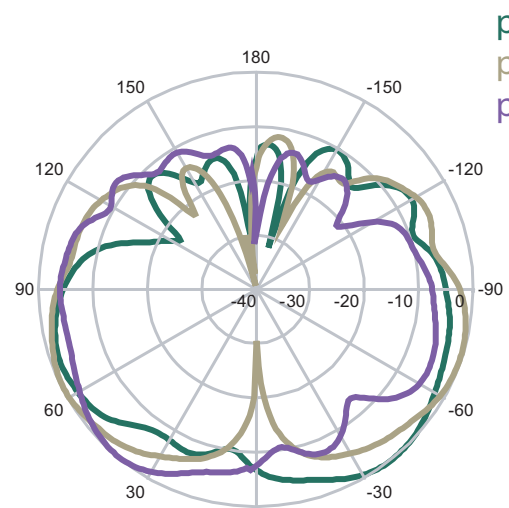

port 1  
port 2  
port 3

horizontal 5470 MHz

vertical 5470 MHz

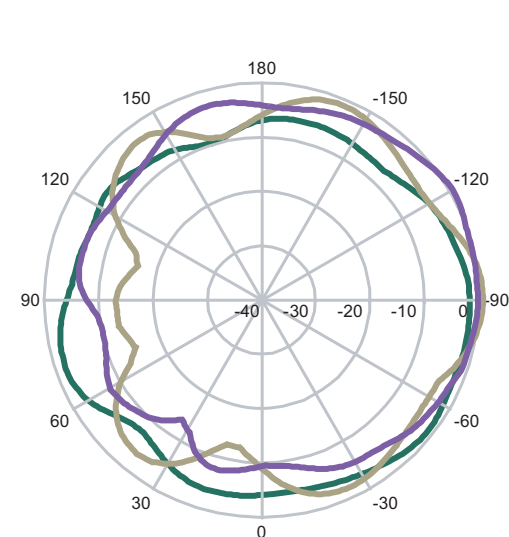

port 1  
port 2  
port 3

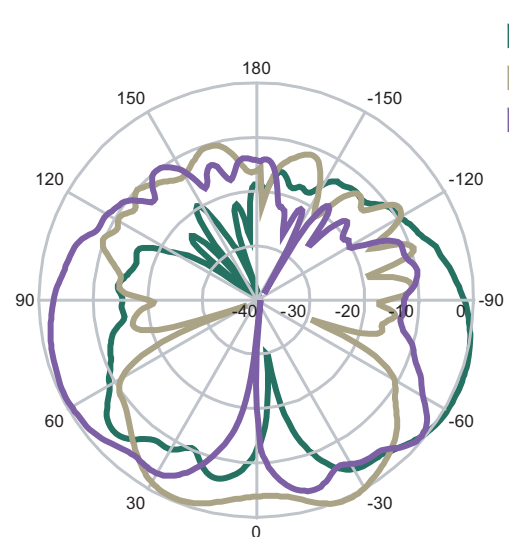

port 1  
port 2  
port 3

Frequency range	2400 MHz ... 2500 MHz 5150 MHz ... 5875 MHz
Gain	3.5 dBi / 5.5 dBi
VSWR (voltage standing wave ratio)	1.8
Polarization	3 × Linear, vertical
HPBW (half power bandwidth)	horizontal 360°
Downtilt	0°
Max. Power	
Impedance	50 Ω
Connector	3 × N male at 3.28 ft (1 m) cable directly attached

*Table 19: Electrical Specification*

Temperature	-40 °F ... +176 °F (-40 °C ... +80 °C)
Radome color	7035 (Light Gray)
Radome material	plastic
Weight	0.66 lb (0.3 kg)
Dimensions	12.2 in × 4.33 in × 1.57 in (310 mm × 110 mm × 40 mm)
Protection class	IP65

*Table 20: Environmental & Mechanical Characteristics*

3 × 3 ft (90 cm) directly mounted to the antenna with N male connectors
3 × Pigtail, R-SMA male to N female
Mounting material

*Table 21: Cable and Accessories*

#### **4.2.5 Dual band Hemispherical Antenna for 2.4 and 5 GHz band**

##### **■ BAT-ANT-N-6ABG-IP65**

Order Number: 943 981-004



Radiation Pattern	
horizontal 2400 MHz	vertical 2400 MHz

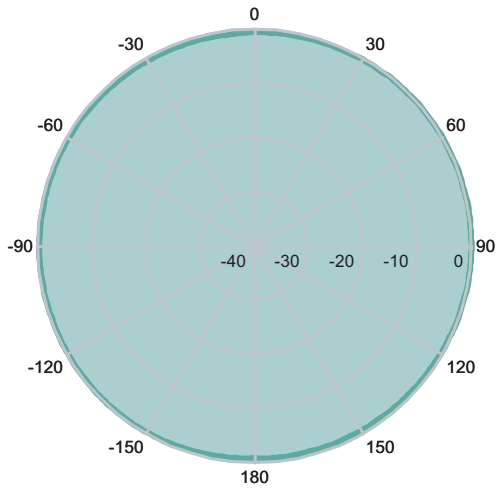

horizontal 5470 MHz

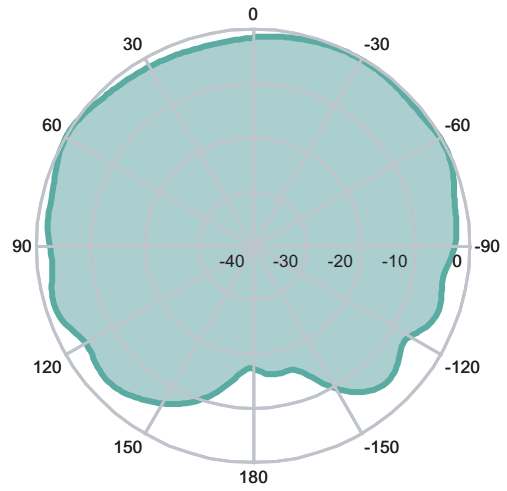

vertical 5470 MHz

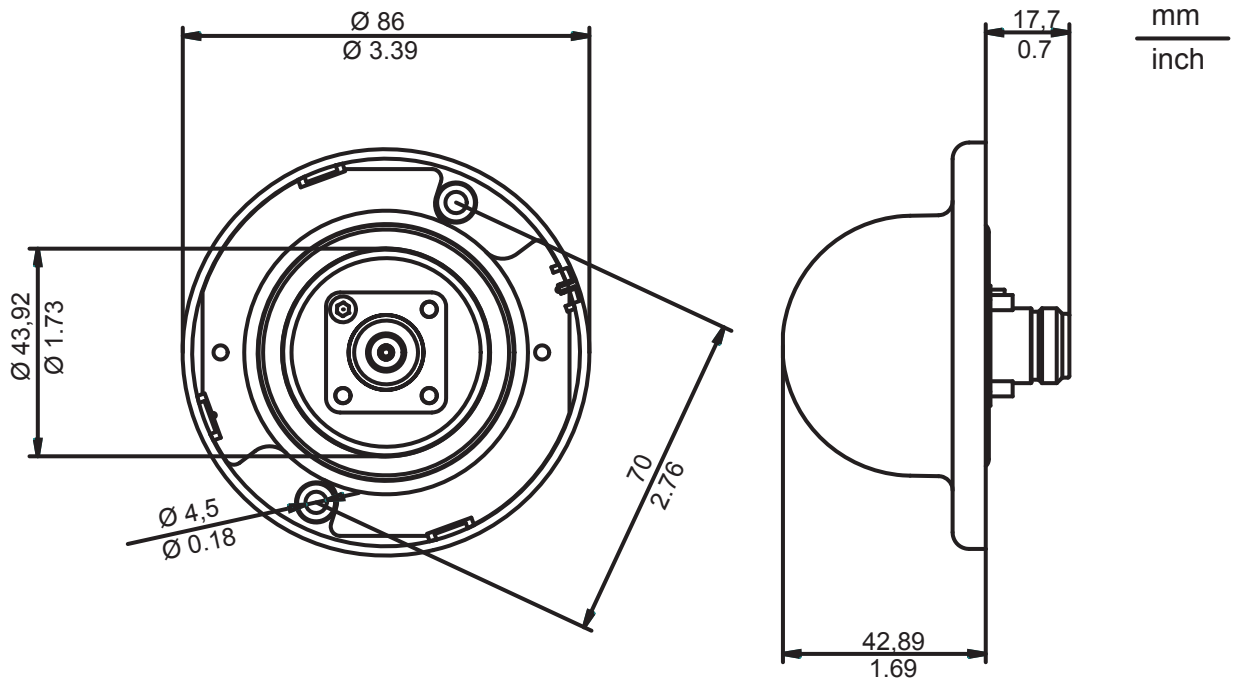
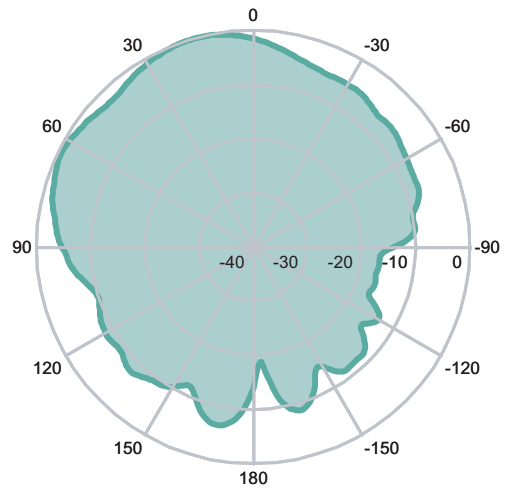
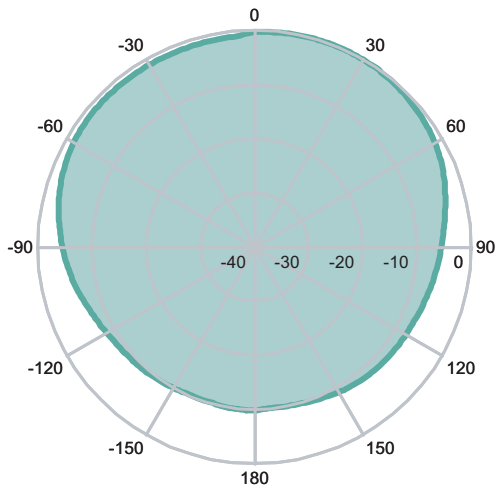

Frequency range	2300 MHz ... 2500 MHz
	4900 MHz ... 5935 MHz
Impedance	50 $\Omega$
VSWR (voltage standing wave ratio)	1.8
Polarization	Linear, vertical
Gain	6 dBi at 2.4 GHz
	8 dBi at 5 GHz
3 dB beamwidth horizontal	at 2.4 GHz 360°
3 dB beamwidth horizontal	at 5 GHz 173°
Max. Power	75 W (CW) at 77 °F (25 °C)

*Table 22: Electrical Specification*

---

3.28 ft (1 m) with N plugs at both ends.  
Pigtail, R-SMA male to N female

---

*Table 23: Cable and Accessories*

## 4.3 Sector Antennas

### 4.3.1 Polarization-diversity antenna for 2.4 GHz band, linear

#### ■ **BAT-ANT-N-8G-DS-IP65**

Order Number: 943 981-009



## Radiation Pattern

horizontal 2400 MHz

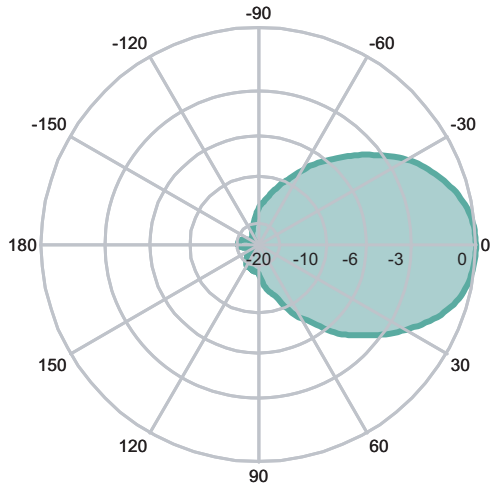

vertical 2400 MHz

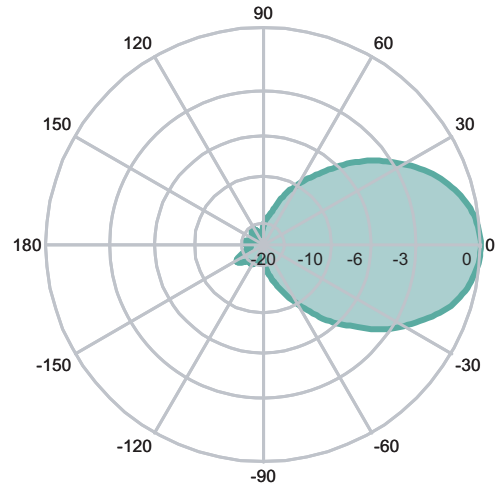

**Table 24: Directional characteristic**

Frequency range	2400 MHz ... 2485 MHz
Impedance	50 $\Omega$
VSWR (voltage standing wave ratio)	1.5
Polarization	dual linear, $\pm 45^\circ$ slant
Gain	8 dBi
3 dB beamwidth horizontal	75°
3 dB beamwidth vertical	70°
Downtilt	0°
Isolation between ports	25 dB
Front to back ratio	14 dB
Max. Power	10 W (CW) at 77 °F (25 °C)
Connector	2 × N female

**Table 25: Electrical Specification**

Dimensions	3.98 in × 3.15 in × 1.38 in (101 mm × 80 mm × 35 mm)
Weight	0.24 lb (0.11 kg)
Radome material	LEXAN EXL 9330
Radome color	RAL 7044 (silk gray)
Operating temperature range	-40 °F ... +176 °F (-40 °C ... +80 °C)
Storage temperature range	-40 °F ... +176 °F (-40 °C ... +80 °C)
Windload	3.37 lbf at 99 m/h (15 N at 160 km/h)
Protection class	IP65

**Table 26: Mechanical Properties**

---

2 × 3.28 ft (1 m) with N male connectors at both ends

---

2 × Pigtail, R-SMA male to N female

---

Mounting material

---

*Table 27: Cable and Accessories*

### 4.3.2 Polarization-diversity antenna for 5 GHz band, linear

#### ■ **BAT-ANT-N-9A-DS-IP65**

Order Number: 943 981-010



---

Radiation Pattern

---

horizontal 5470 MHz

---

vertical 5470 MHz

---

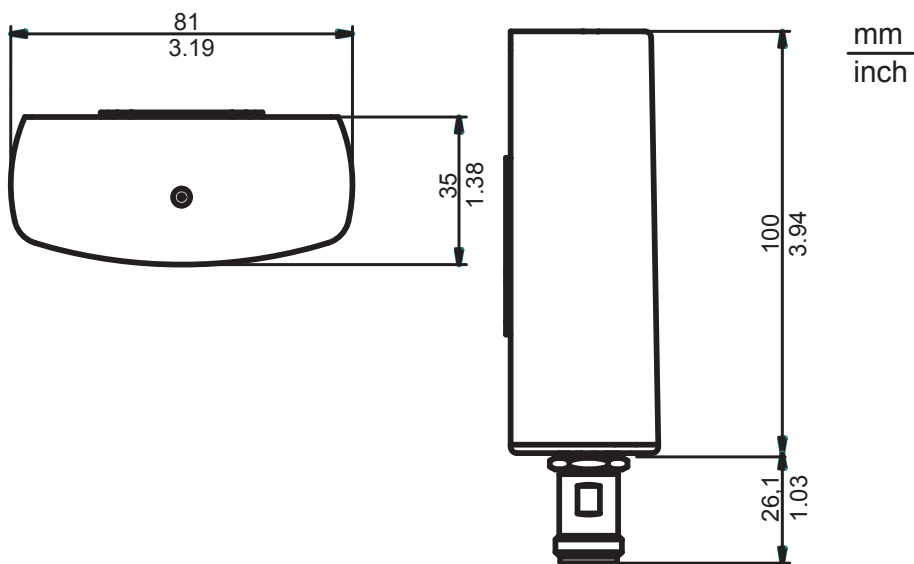
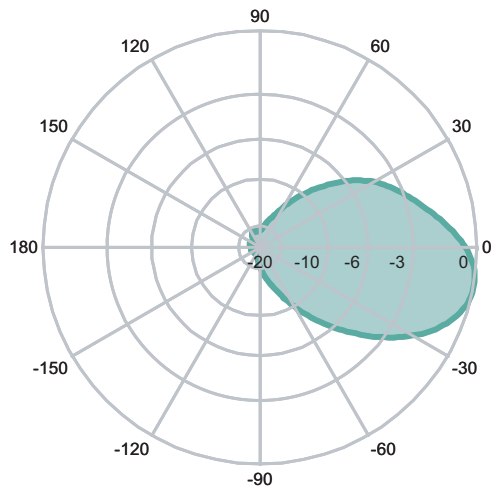
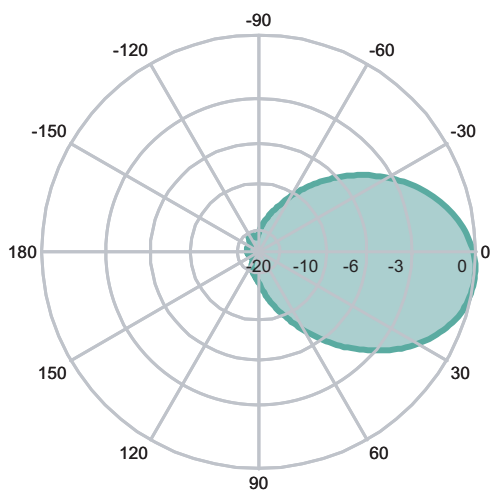

Frequency range	5150 MHz ... 5925 MHz
Impedance	50 $\Omega$
VSWR (voltage standing wave ratio)	2
Polarization	dual linear, $\pm 45^\circ$ slant
Gain	9 dBi
3 dB beamwidth horizontal	70°
3 dB beamwidth vertical	60°
Downtilt	0°
Isolation between ports	20 dB
Front to back ratio	20 dB
Max. Power	10 W (CW) at 77 °F (25 °C)
Connector	2 $\times$ N female

*Table 28: Electrical Specification*

Dimensions	3.98 in × 3.15 in × 1.38 in (101 mm × 80 mm × 35 mm)
Weight	0.24 lb (0.11 kg)
Housing material	ASA and aluminum
Radome material	ASA
Radome material	LEXAN EXL 9330
Radome color	RAL 7044 (silk gray)
Operating temperature range	-40 °F ... +176 °F (-40 °C ... +80 °C)
Storage temperature range	-40 °F ... +176 °F (-40 °C ... +80 °C)
Windload	3.37 lbf at 99 m/h (15 N at 160 km/h)
Protection class	IP65

*Table 29: Mechanical Properties*

2 × 3.28 ft (1 m) with N male connectors at both ends
2 × Pigtail, R-SMA male to N female
Mounting material

*Table 30: Cable and Accessories*

### 4.3.3 Sectoral MiMoantenna for 5 GHz band

#### ■ **BAT-ANT-N-MiMo5-9N-IP65**

Order Number: 943 981-013



Radiation Pattern	
horizontal – connection 1	vertical – connection 1



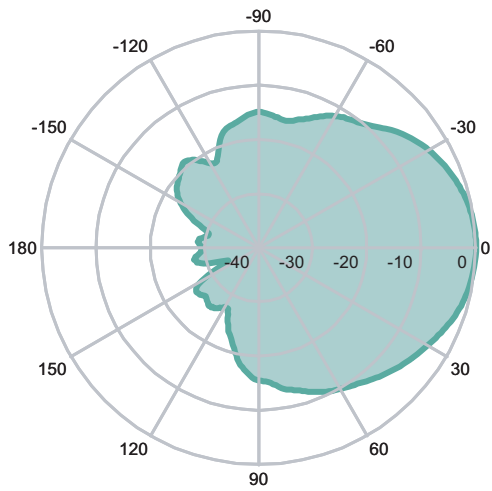

horizontal – connection 2

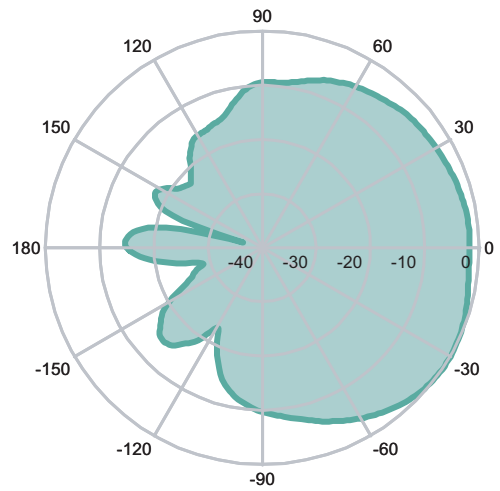

vertical – connection 2

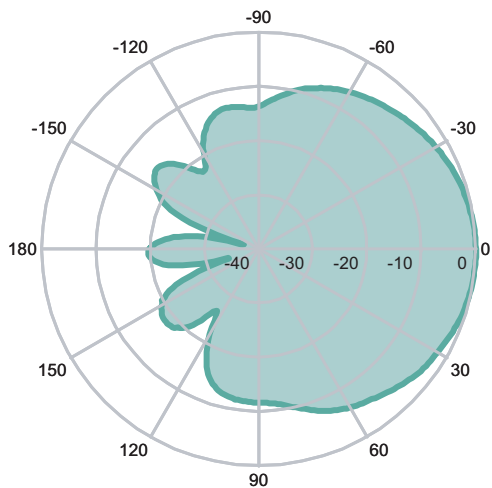

horizontal – connection 3

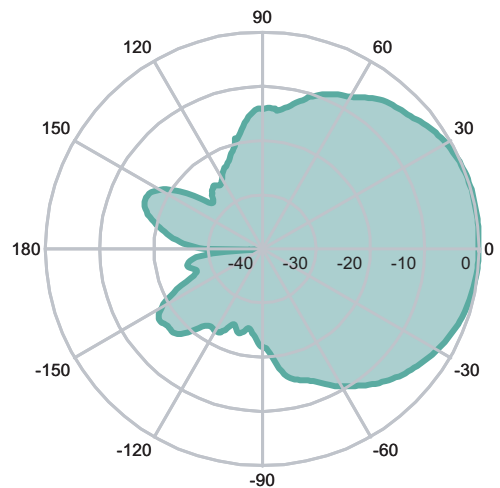

vertical – connection 3

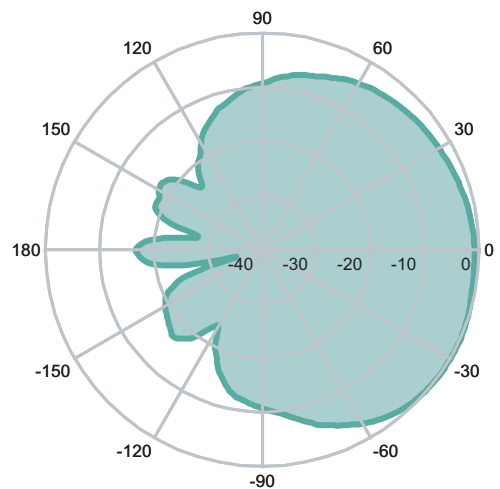
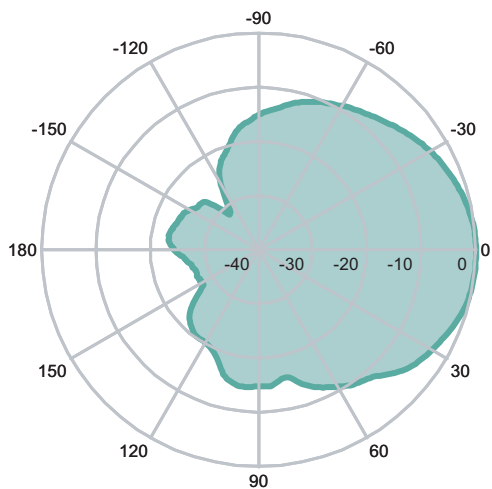

Frequency range	5150 MHz ... 5875 MHz
Impedance	50 Ω
VSWR (voltage standing wave ratio)	1.5
Polarization	3 × linear vertical / horizontal / +45°

Table 31: Electrical Specification

Gain	9 dBi
3 dB beamwidth horizontal	65°
3 dB beamwidth vertical	65°
Downtilt	0°
Max. Power	2 W (CW) at 77 °F (25 °C)
Connector	N female

*Table 31: Electrical Specification*

Dimensions	3.98 in × 3.15 in × 1.38 in (101 mm × 80 mm × 35 mm)
Weight	0.24 lb (0.11 kg)
Radome material	LEXAN EXL 9330
Radome color	RAL 7044 (silk gray)
Operating temperature range	-40 °F ... +176 °F (-40 °C ... +80 °C)
Storage temperature range	-40 °F ... +176 °F (-40 °C ... +80 °C)
Windload	3.37 lbf at 99 m/h (15 N at 160 km/h)
Protection class	IP65

*Table 32: Mechanical Properties*

3 × 3.28 ft (1 m) with N male connectors at both ends
3 × Pigtail, R-SMA male to N female
Mounting material

*Table 33: Cable and Accessories*

## 4.4 Directional Antennas

### 4.4.1 Directional antenna for the 2.4 GHz band with 14 dBi gain

#### ■ **BAT-ANT-N-14G-IP23**

Order Number: 943 981-005



---

Radiation Pattern

---

horizontal 2400 MHz

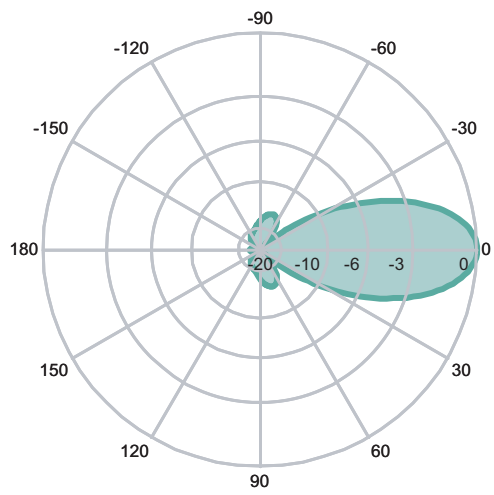

vertical 2400 MHz

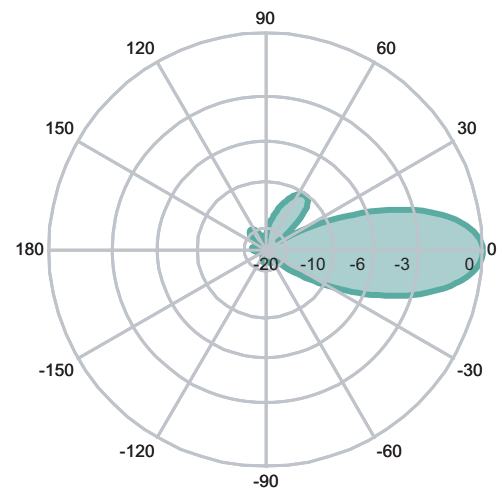

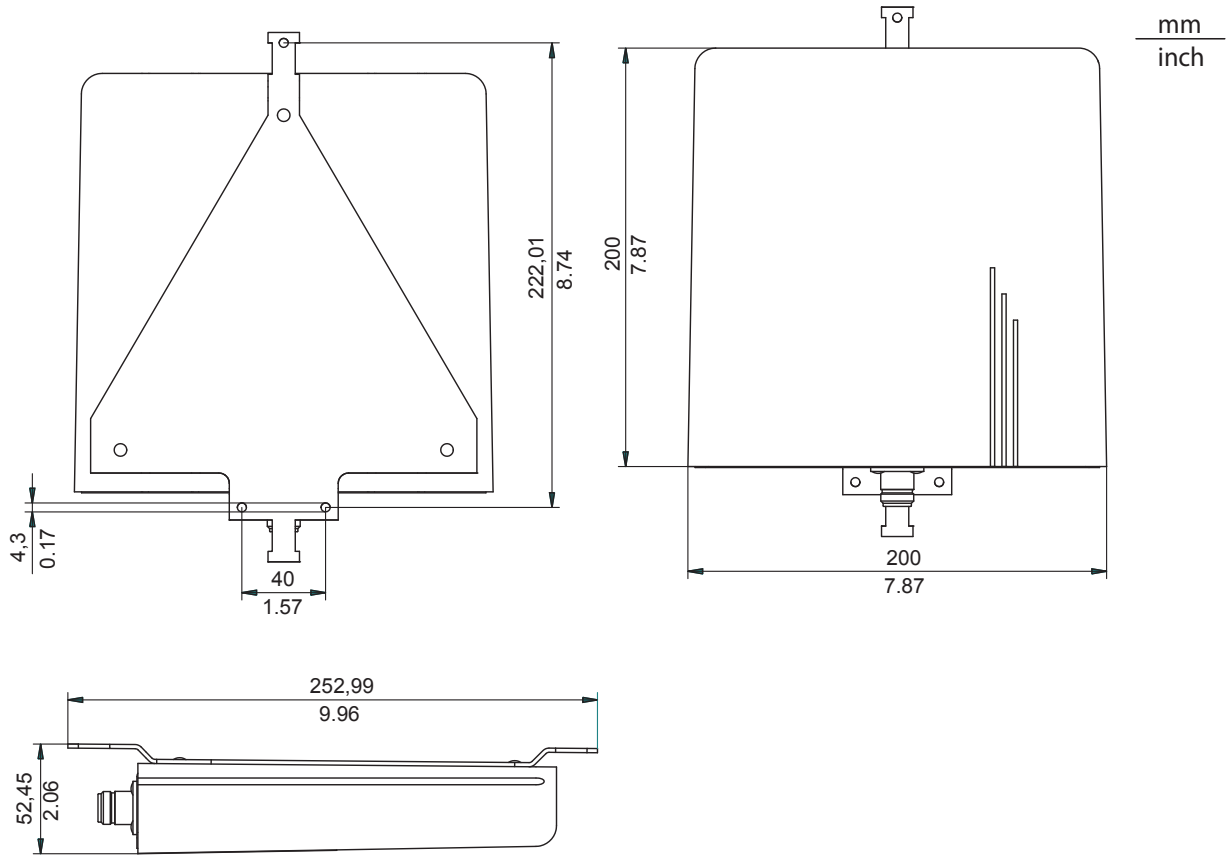

Frequency range	2300 MHz ... 2500 MHz
Impedance	50 Ω
VSWR (voltage standing wave ratio)	1.5
Polarization	vertical
Gain	14 dBi
3 dB beamwidth horizontal	35°
3 dB beamwidth vertical	30°
Downtilt	0°
Front to back ratio	20 dB
Max. Power	75 W (CW) at 77 °F (25 °C)
Connector	N female

**Table 34: Electrical Specification**

Dimensions	3.98 in × 3.15 in × 1.38 in (101 mm × 80 mm × 35 mm)
Weight	0.24 lb (0.11 kg)
Radome material	LEXAN EXL 9330
Radome color	RAL 7044 (silk gray)
Operating temperature range	-40 °F ... +176 °F (-40 °C ... +80 °C)
Storage temperature range	-40 °F ... +176 °F (-40 °C ... +80 °C)
Windload	3.37 lbf at 99 m/h (15 N at 160 km/h)
Protection class	IP23

**Table 35: Mechanical Properties**

---

3.28 ft (1 m) with N plugs at both ends.

---

Pigtail, R-SMA male to N female

---

Mounting material

---

*Table 36: Cable and Accessories*

**Note:** Applies for use in the EU: If you use the antenna BAT-ANT-N-14G-IP23 in combination with OpenBAT family devices, use the supplied 1 m (3.28ft) antenna cable in combination with BAT-CLB-2 N m-f cable.

## 4.4.2 Directional antenna for 5 GHz band with 18 dBi gain

### ■ **BAT-ANT-N-18A-V-IP65**

Order Number: 943 981-006



Due to their compact design, several of these antennas can be mounted on a single post. For better separation of the spatial streams with MiMo, you mount the antennas with different alignments (polarizations).

Example:

1st antenna: vertical

2nd antenna: horizontal

3rd antenna: 45° horizontal

---

#### Radiation Pattern

horizontal 5470 MHz

vertical 5470 MHz

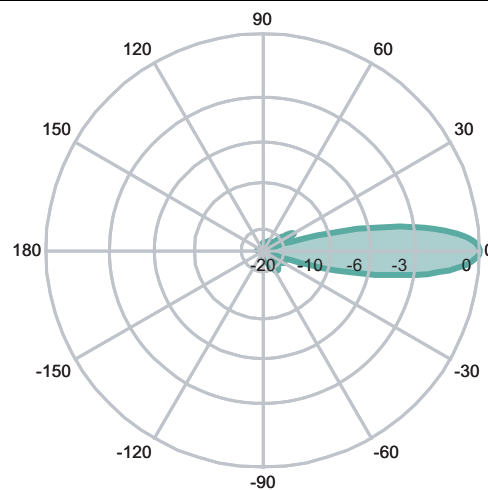
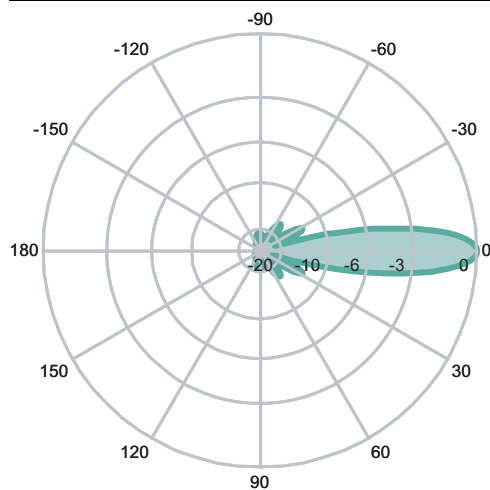

---

Frequency range

5150 MHz ... 5250 MHz

5250 MHz ... 5350 MHz

5350 MHz ... 5725 MHz

5725 MHz ... 5875 MHz

---

Gain

18 dBi

19 dBi

18.5 dBi

18 dBi

---

Table 37: Electrical Specification

Polarization	Linear, vertical
HPBW / horizontal	18°
HPBW / vertical	18°
Front to back ratio	> 30 dB
Power handling	6 W (CW)
Impedance	50 Ω
Connector	N Jack

*Table 37: Electrical Specification*

Windload @ wind speed	23.4 lbf at 134 mi/h (104 N at 216 km/h)
Temperature	-49 °F ... +158 °F (-45 °C ... +70 °C)
Radome material	plastic
Radome color	7035 (Light Gray)
Weight	0.11 kg, 0.24 lb
Dimensions	7.48 in × 7.48 in × 1.2 in (190 mm × 190 mm × 30.5 mm)
Protection class	IP65 / IP67

*Table 38: Environmental & Mechanical Characteristics*

3.28 ft (1 m) with N plugs at both ends.
Pigtail, R-SMA male to N female
Mounting material

*Table 39: Cable and Accessories*

### ■ **BAT-ANT-N-MiMo5-18N-IP65**

Order Number: 943 981-014

MiMo is achieved via polarization diversity.



Relevant for North America:

[See “Legal regulations for operation external antennas” on page 15.](#)

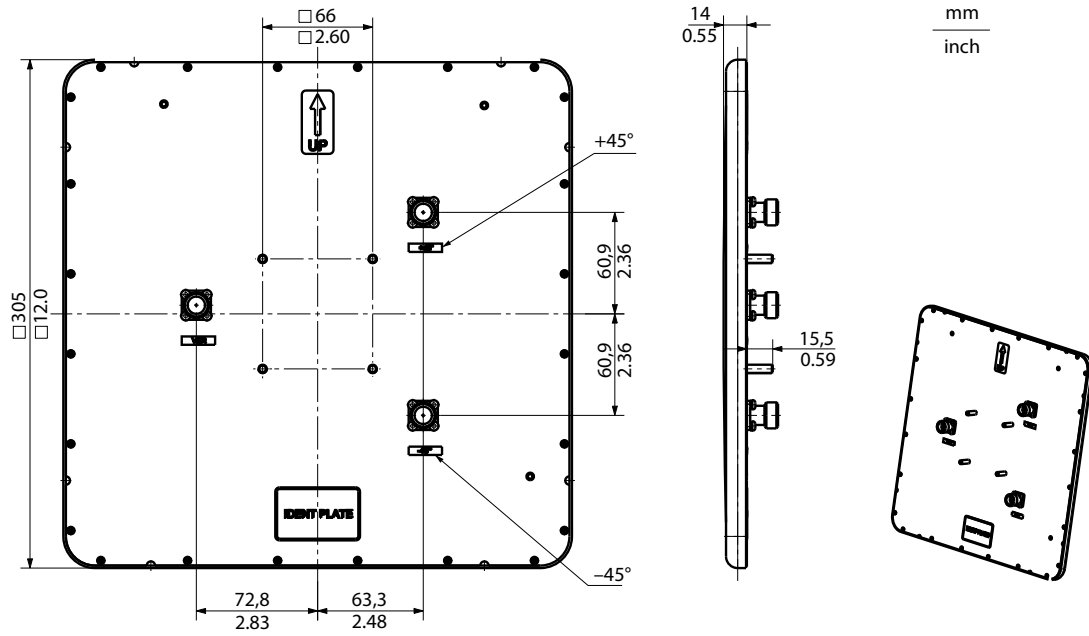

**Radiation Pattern**

5 GHz

horizontal - connection on the right (+45°)

vertical - connection on the right (+45°)

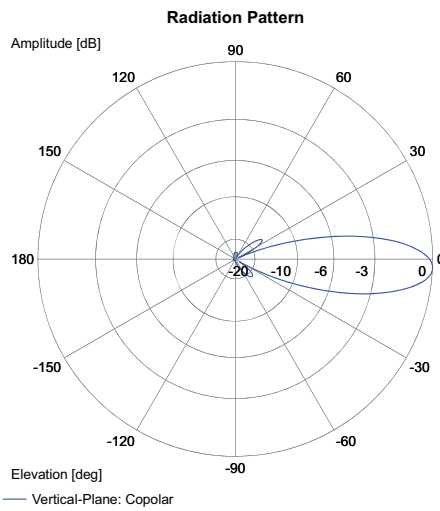
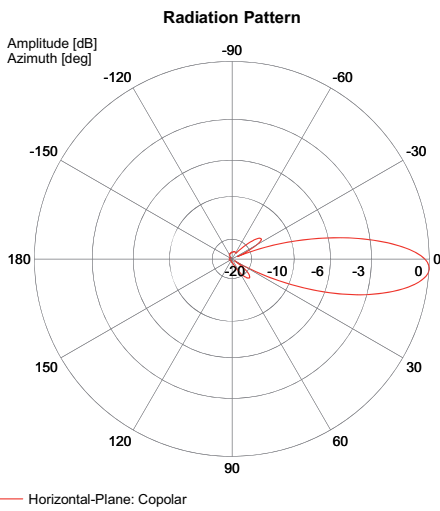

horizontal - connection on the left (-45°)

vertical - connection on the left (-45°)



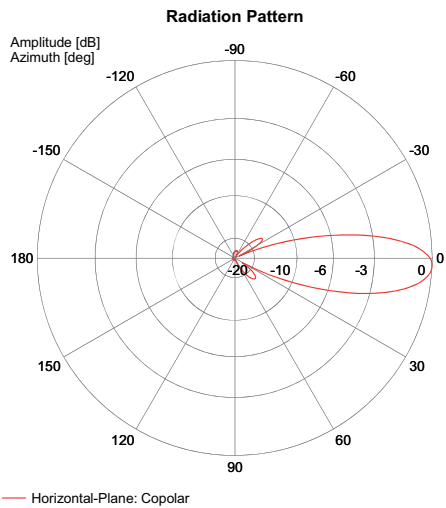

horizontal - vertical connection

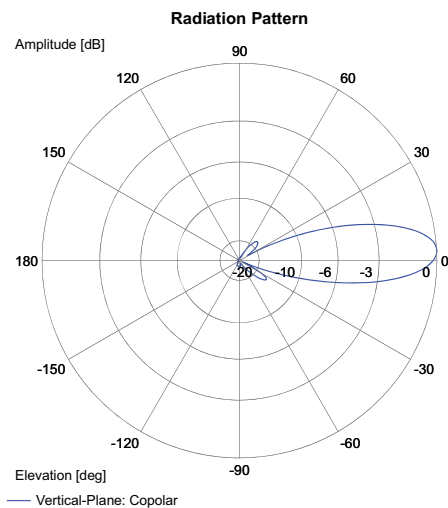

vertical - vertical connection

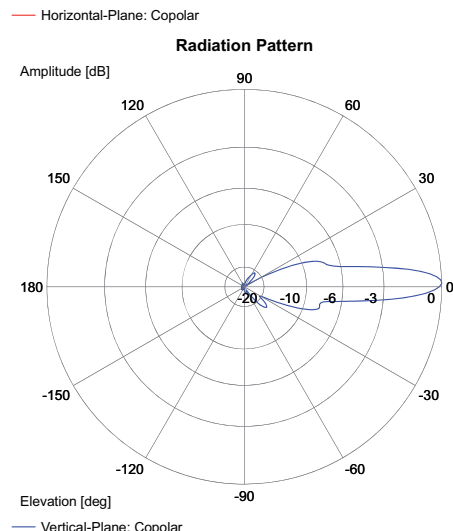
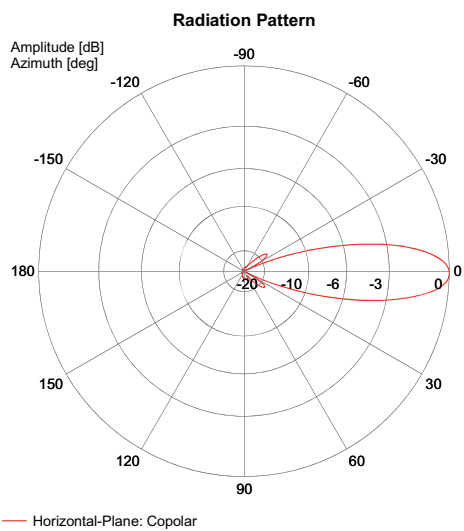

	Band 1	Band 2	Band 3
Frequency range	4900 MHz ... 5150 MHz	5150 MHz ... 6000 MHz	6000 MHz ... 6100 MHz
VSWR (voltage standing wave ratio)	1.8	1.8	1.8
Gain	17 dBi	18 dBi	16 dBi
HPBW / vertical	20°		15°

Table 40: Electrical Specification

Polarization	0°, +/-45° inclination
Max. Power	6 W
Impedance	50 Ω
Connector	N Jack

Table 41: General data

Windload @ survival speed	263 N at 136 m/h (263 N at 220 km/h)
Temperature	-49 °F ... +158 °F (-45 °C ... +70 °C)
Radome material	plastic
Radome color	Grey-white
Weight	3.31 lb (1.5 kg)
Dimensions	12.01 in × 12.01 in × 0.59 in (305 mm × 305 mm × 15 mm)
Protection class	IP67

Table 42: Environmental & Mechanical Characteristics

3 × 3.28 ft (1 m) with N male connectors at both ends
3 × Pigtail, R-SMA male to N female
Mounting material for wall and mast mount

Table 43: Cable and Accessories

### 4.4.3 Directional antenna for 5 GHz band with a gain of 23 dBi

- **BAT-ANT-N-23A-V-IP65**  
Order Number: 943 981-007



Relevant for North America:

Operate the antennas BAT-ANT-N-23A-V-IP65 and BAT-ANT-N-23A-VH-IP65 exclusively in point-to-point connections.

Due to their compact design, several of these antennas can be mounted on a single post. For better separation of the spatial streams with MiMo, you mount the antennas with different alignments (polarizations).

Example:

1st antenna: vertical

2nd antenna: horizontal

3rd antenna: 45° horizontal

---

## Radiation Pattern

---

horizontal 5470 MHz

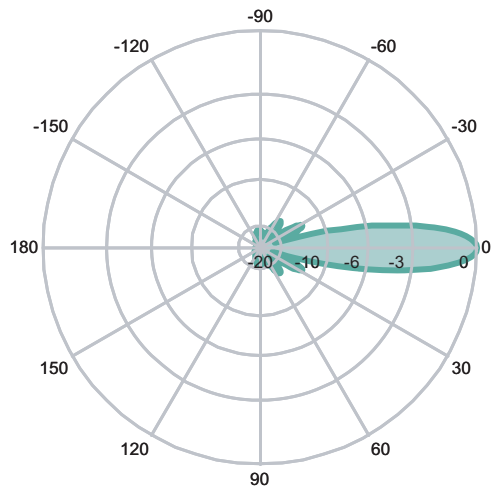

vertical 5470 MHz

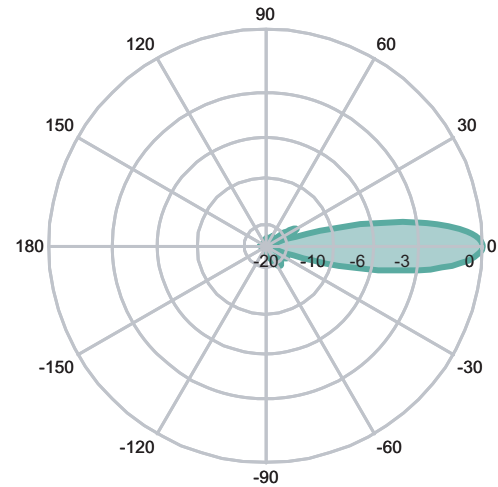

---

Frequency range	5150 MHz ... 5350 MHz 5470 MHz ... 5875 MHz
Gain	23 dBi
VSWR (voltage standing wave ratio)	< 1.5
Polarization	Linear, vertical
HPBW / horizontal	9°
HPBW / vertical	9°
Front to back ratio	> 30 dB
Max. Power	6 W
Impedance	50 Ω
Connector	N Jack

---

*Table 44: Electrical Specification*

---

Windload @ wind speed	59.3 lbf at 136 m/h (264N at 220 km/h)
Temperature	-49 °F ... +158 °F (-45 °C ... +70 °C)
Radome material	plastic
Radome color	Grey-white
Weight	3.31 lb (1.5 kg)
Dimensions	12.01 in × 12.01 in × 0.98 in (305 mm × 305 mm × 25 mm)
Protection class	IP65 / IP67

---

*Table 45: Environmental & Mechanical Characteristics*

---

3.28 ft (1 m) with N plugs at both ends.  
Pigtail, R-SMA male to N female  
Mounting material for wall and mast mount

---

*Table 46: Cable and Accessories*

# BAT-ANT-N-23A-VH-IP65

Order number: 943 981-008

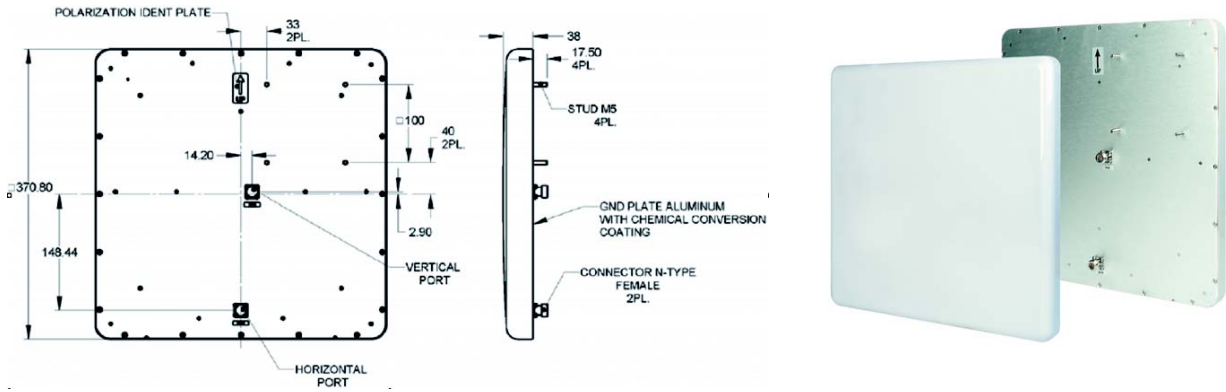

## Radiation Pattern

Connection: horizontal / polarization: horizontal  
(5,470 MHz)

Connection: horizontal / polarization: vertical  
(5,470 MHz)

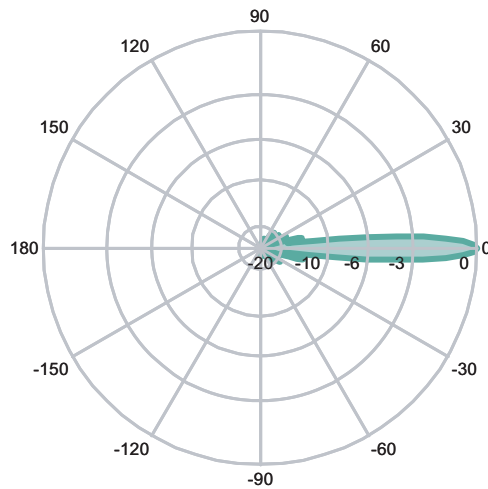
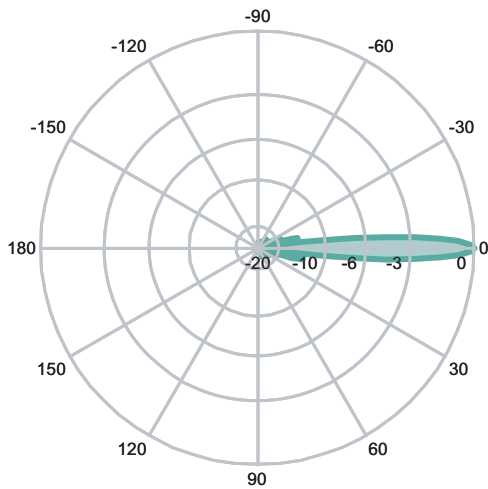

Connection: vertical / polarization: horizontal  
(5,470 MHz)

Connection: vertical / polarization: vertical  
(5,470 MHz)

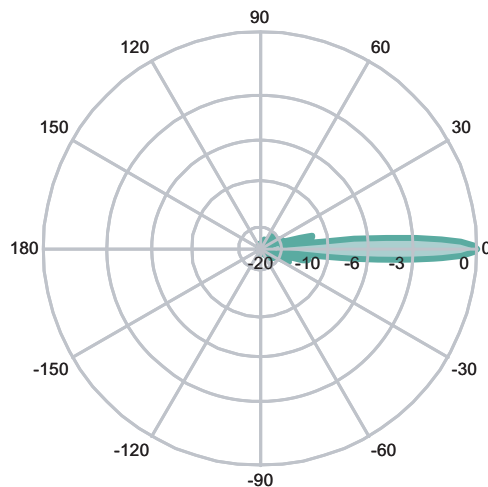
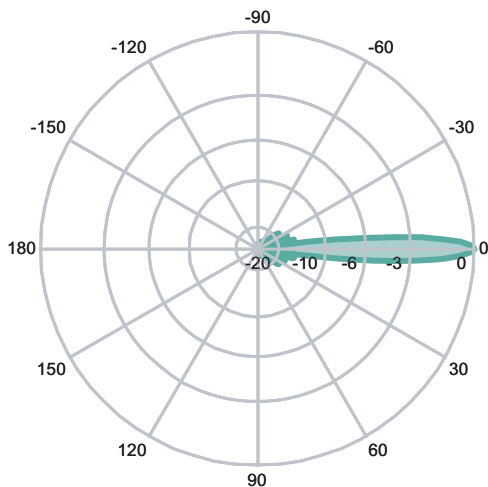

Frequency range	5150 MHz ... 5875 MHz
Gain	23 dBi
VSWR (voltage standing wave ratio)	< 1.7
Polarization	dual Linear, vertical and horizontal
HPBW / horizontal	9°
HPBW / vertical	9°
Front to back ratio	-30 dB
Max. Power	6 W
Impedance	50 Ω
Connector	2 × N female

*Table 47: Electrical Specification*

Windload @ survival speed	59.3 lbf at 136 m/h (264N at 220 km/h)
Temperature	-49 °F ... +158 °F (-45 °C ... +70 °C)
Radome material	plastic
Radome color	Grey-white
Weight	5.51 lb (2.5 kg)
Dimensions	14.61 in. × 14.61 in. × 1.57 in. (371 mm × 371 mm × 40 mm)
Protection class	IP65 / IP67

*Table 48: Environmental & Mechanical Characteristics*

2 × 3.28 ft (1 m) with N male connectors at both ends
2 × Pigtail, R-SMA male to N female
Mounting material for wall and mast mount

*Table 49: Cable and Accessories*

## 4.5 Radiating Cable Antennas (Leaky Cable)

### 4.5.1 Leaky Cable for 2.4 GHz; black

Radiating cables are coaxial cables that are equipped with small slots in their shields at regular intervals that operate as antennas. This leads to a homogeneous field around the cable.

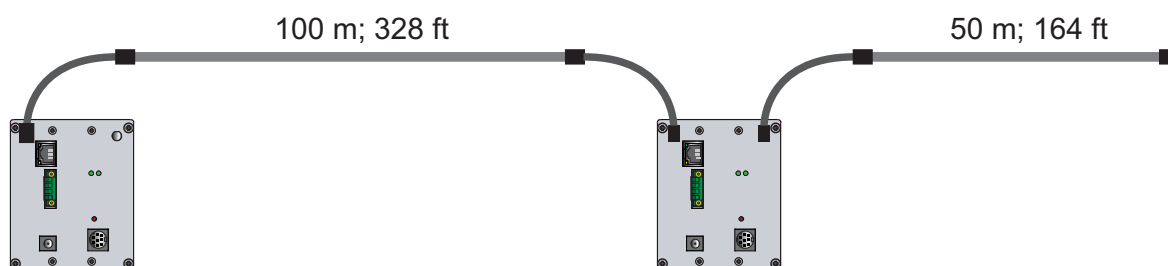

The 100 m (328 ft) cable is designed to be fed by 2 access points, each feeding the cable for approximately 50 m (164 ft). The 50 m (164 ft) cable is designed to be used with one Access Point and equipped with a terminator at the end.

## ■ **BAT-ANT-N-LC-G-50m-IP65**

Order Number: 943 981-001



Cable length	164 ft (50 m)
Cable specification	2 × N male connectors; 0.15 dB at 2.4 GHz

*Table 50: Specification*

Frequency band	2000 MHz ... 2900 MHz
Antenna connector	N-type male

*Table 51: Radio technology*

Operating temperature	-40 °F ... +185 °F (-40 °C ... +85 °C)
Storage/transport temperature	-70 °C ... +85 °C
Dimensions	164 ft (50 m); d = 0.6 in (15 mm)
Protection class	IP65
Weight	26.5 lb (12 kg)

*Table 52: Ambient conditions*

Halogen free and flame retardant outer sheath
Low corrosive gas emission according to IEC 60754-2
Flame retardant according to IEC 60332-1 and IEC 60332-3 cat. C
Low smoke emission according to IEC 61034

*Table 53: Flammability Characteristics*

Leaky Cable
2 × N-connector, pre-assembled
1 × terminating resistor 50 Ohm
50 × fastening clip

*Table 54: Scope of delivery and accessories*

## ■ **BAT-ANT-N-LC-G-100m-IP65**

Order Number: 943 981-101



Cable length	100 m, 328 ft
Cable specification	2 × N male connectors; 0.15 dB at 2.4 GHz

*Table 55: Specification*

Frequency band	2000 MHz ... 2900 MHz
Antenna connector	N-type male

*Table 56: Radio technology*

Operating temperature	-40 °F ... +185 °F (-40 °C ... +85 °C)
Storage/transport temperature	-70 °C ... +85 °C
Dimensions	328 ft (100 m); d = 0.6 in (15 mm)
Protection class	IP65
Weight	53 lb (24 kg)

*Table 57: Ambient conditions*

Halogen free and flame retardant outer sheath
Low corrosive gas emission according to IEC 60754-2
Flame retardant according to IEC 60332-1 and IEC 60332-3 cat. C
Low smoke emission according to IEC 61034

*Table 58: Flammability Characteristics*

Leaky Cable
2 × N-connector, preassembled
1 × terminating resistor 50 Ohm
100 × fastening clip

*Table 59: Scope of delivery and accessories*

### Configurations Longitudinal Attenuation

	db/328 ft (dB/100 m)
LC at 4 in (10 cm) from a concrete floor	15
LC at 0.6 in (15 mm) from a metal surface	17
LC directly against a metal surface	34

*Table 60: Longitudinal attenuation of both cables between 2.4 and 2.485 GHz*

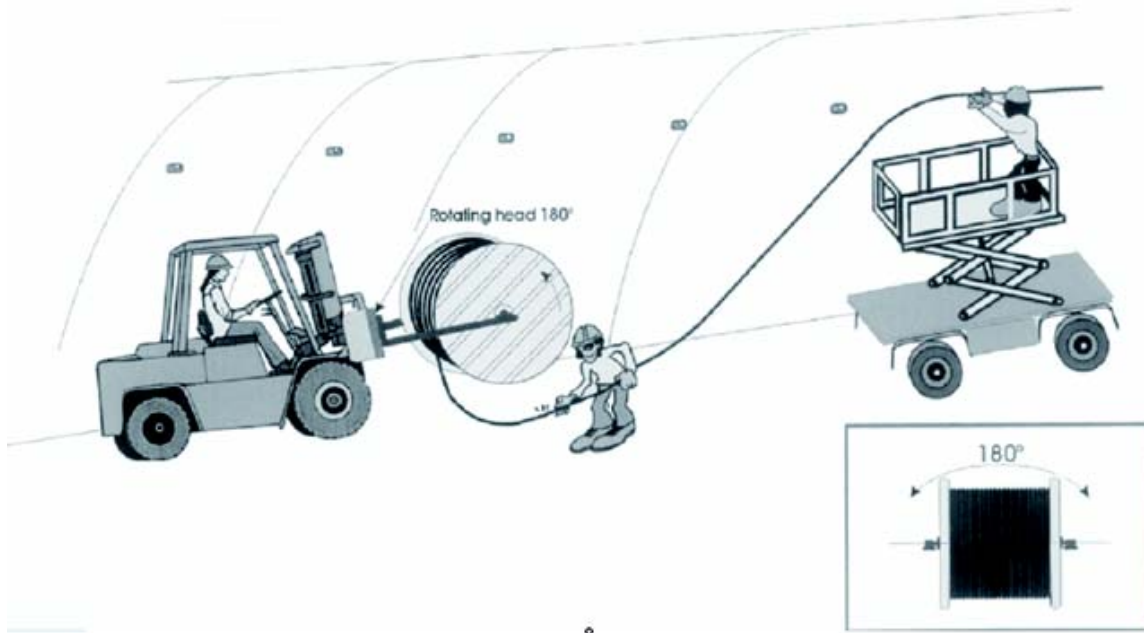

Figure 1: Mounting a leaky wave conductor in the tunnel. Fastening clips are included in the delivery.



## 5 Cables/Adapter

All antennas are supplied with 1 m cable / N-plug to N-plug and pigtail.

### ■ **BAT-CLB-2 N m-m, BAT-CLB-2 N m-f**

Order Number:	m-m: 943 903-513
	m-f: 943 903-514



Length	6.56 ft (2 m)
Diameter	6 mm
Attenuation	1.4 dB / 2.4 GHz 3 dB / 5 GHz
Connector	N male to female
Protection class	IP65

*Table 61: Characteristics*

Temperature range	-40 °F ... +185 °F (-40 °C ... +85 °C)
Installation temperature range	-20 °C ... +60 °C
Flammability	UL 1581 § 1080 (VW-1)
Halogen-free	in compliance with IEC 60754
2002/95/EC (RoHS) compliant	

*Table 62: Flammability Characteristics*

## ■ **BAT-CLB-5 N m-f**

Order Number: 943 903-516



Length	16.4 ft (5 m)
Diameter	13 mm
Attenuation	1.3 dB / 2.4 GHz 2.3 dB / 5 GHz
Connector	N male/ N female

*Table 63: Characteristics*

Temperature range	-40 °F ... +185 °F (-40 °C ... +85 °C)
Installation temperature range	-20 °C ... +60 °C
Flammability	UL 1581 § 1080 (VW-1)
Halogen-free	in compliance with IEC 60754
2002/95/EC (RoHS) compliant	

*Table 64: Flammability Characteristics*

## ■ **BAT-CLB-15 N m-f**

Order Number: 943 903-515



Length	49.21 ft (15 m)
Diameter	13 mm
Attenuation	3 dB / 2.4 GHz 4 dB / 5 GHz
Connector	N male/ N female

*Table 65: Characteristics*

Temperature range	-40 °F ... +185 °F (-40 °C ... +85 °C)
Installation temperature range	-20 °C ... +60 °C
Flammability	UL 1581 § 1080 (VW-1)
Halogen-free	in compliance with IEC 60754
2002/95/EC (RoHS) compliant	

*Table 66: Flammability Characteristics*

## ■ **BAT-Pigtail**

Order Number: 943 903-360



Length	0.66 ft (0.2 m)
Diameter	6 mm
Attenuation	0.5 dB / 2.4 GHz 1 dB / 5 GHz
Connector	N female/ RPSMA-Plug

*Table 67: Characteristics*

## ■ **BAT-ANT-Protector m-f**

Order Number: 943 903-373



The BAT-ANT-Protector m-f is a bandpass with electrical insulation. It helps prevent damage due to electrostatic discharging.

The BAT-ANT-Protector m-f can enable a watertight connection to the switch cabinet.

This device is strongly recommended to be used in- and outdoor wherever electrical discharge, overvoltage or unclear grounding occur. Please refer to the Outdoor Installation Guide for how to mount and plan the installation.

Main path connectors



**Connection 1:** N socket, unprotected

**Connection 2:** N plug, protected (electrically isolated)

Mounting and grounding	MH170/brk (MH=bulkhead mounting/brk=bracket)
Side of bulkhead	protected side
Design specialty	inline design

*Table 68: Product Configuration*

Impedance	50 $\Omega$
Frequency range	2000 MHz ... 6000 MHz
Return loss	$\geq 20$ dB
Insertion loss	$\leq 0.2$ dB
RF CW power	$\leq 300$ W
Surge current handling capability	50 multiple kA (test pulse 8/20 $\mu$ s)
Residual pulse energy	0.0001 $\mu$ J typically (test pulse 4 kV 1.2/50 $\mu$ s / 2 kA 8/20 $\mu$ s) Main path - protected side

*Table 69: Electrical Specification*

Weight	0.19 lb (0.085 kg)
Operating temperature	-40 °F ... +185 °F (-40 °C ... +85 °C)
Waterproof degree	IP65 (according to IEC 60529, data refers to the coupled state)
2002/95/EC (RoHS)	compliant

*Table 70: Environmental & Mechanical Characteristics*

## ■ **BAT-LAN-Protector IP68**

Order Number: 943 903-374



Overvoltage protector for the PoE/LAN cable.

Please refer to the Outdoor Installation Guide for how to mount and plan the installation.

Main path connectors	RJ45 jack (female) – RJ45 jack (unprotected side – protected side)
Mounting	via mounting bracket
Grounding	via mounting bracket or grounding M6 screw (ring of cable shoe > 0.26 in (6.5 mm))

*Table 71: Product Configuration*

Data transmission rate	1000 Mbit/s	
Frequency range	DC to 100 MHz	
Impedance	100 Ω	
Current rating	per pair	1.5 A max.
Response Time	2 ns	
Current handling capability	wire - wire	0.1 kA (test pulse 8/20 μs)
	wire - ground	2.5 kA (test pulse 8/20 μs)
	shield – ground	6 kA (test pulse 8/20 μs)
Protection level	wire - wire	20 V typically (test pulse 4 kV 1.2/50 μs / 2 kA 8/20 μs)
	wire - ground	700 V typically (test pulse 4 kV 1.2/50 μs / 2 kA 8/20 μs)
	shield – ground	700 V typically (test pulse 4 kV 1.2/50 μs / 2 kA 8/20 μs)
Clamping voltage	wire - wire	15 V
	wire - ground	90 V
	shield – ground	90 V

*Table 72: Electrical Specification*

Cable category	according to ISO/IEC 11801:2002 class D specified (up to CAT-5e system)
Operating temperature	-40 °F ... +185 °F (-40 °C ... +85 °C)
Protection class	IP68
Weight	0.73 lb (0.33 kg)

*Table 73: Environmental & Mechanical Characteristics*

## **A Explanation of passive antennas in explosive hazard areas**

Hirschmann BAT antennas are passive devices which are not able to increase the power by themselves.

Devices which are specified in accordance with the ATEX directive complying with the technical standards EN 60079-0 and EN 60079-15 can be operated with all associated Hirschmann BAT antennas. You recognize the specified devices by their device label.

With the use of the prescribed device configuration, the 2 Watts maximum power permitted for the ATEX equipment group IIC is not reached in the following bands:

- ▶ 2.4 GHz ... 2.4835 GHz
- ▶ 5.15 GHz ... 5.35 GHz
- ▶ 5.47 GHz ... 5.725 GHz



## B Antenna diagrams

This chapter was produced with the generous support of Huber+Suhner GmbH.

### ■ Polarization and transmission

The following section explains the vertical and horizontal polarization:

#### ▶ Vertical polarization

With vertical polarization, the electrical field runs perpendicular to the earth's surface. The magnetic field runs perpendicular to the electrical field in transmission direction 'z' - that is, parallel to the earth's surface.

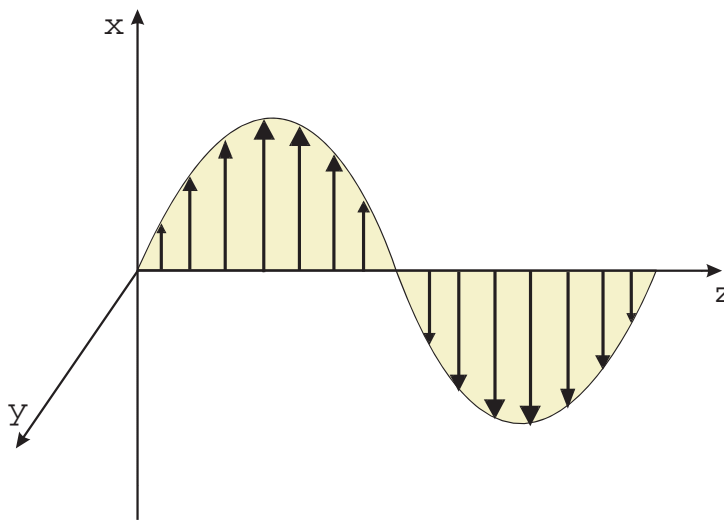

Figure 2: Electrical field in transmission direction 'z'

#### ▶ Horizontal polarization

With horizontal polarization, the electrical field runs parallel to the earth's surface. The magnetic field runs perpendicular to the electrical field in transmission direction 'z' - that is, perpendicular to the earth's surface.

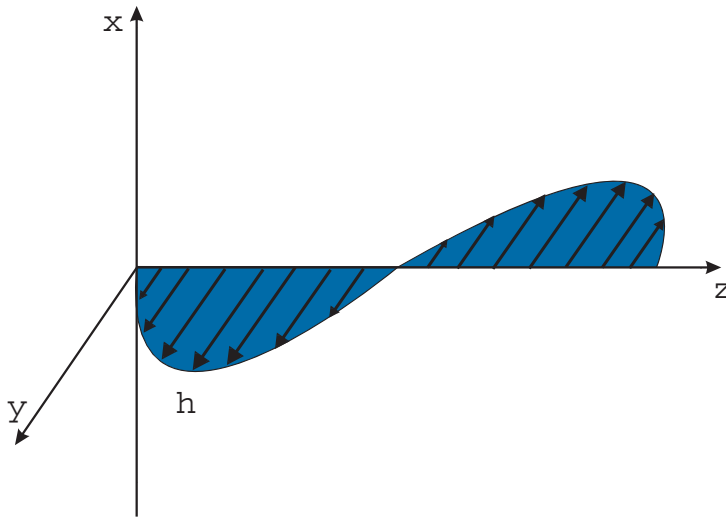

Figure 3: Electrical field in transmission direction 'z'

### ■ Interpreting antenna diagrams

The antenna diagrams used in this document show the directional characteristic of the relevant antenna in horizontal and vertical cross-sections.

When interpreting antenna diagrams, note the following:

- ▶ Antenna diagrams only specify relative outputs.
- ▶ The relative output of the antenna depends on the observed angle.
- ▶ The maximum output of an antenna is standardized to 0 dB in the antenna diagram.
- ▶ Angles in the antenna diagram with 0 dB are known as main lobes.
- ▶ Angles in the antenna diagram with less than 0 dB are known as side lobes.
- ▶ The antenna diagram does not tell you anything about the absolute output of the antenna nor about the range of the antenna nor the antenna gain.

The following is an example of an interpretation of antenna diagrams:

**Omni-directional antenna, horizontal cross-section, antenna viewed from above**

**Omni-directional antenna, vertical cross-section, antenna viewed from the side**

in all angles ca. 0 dB

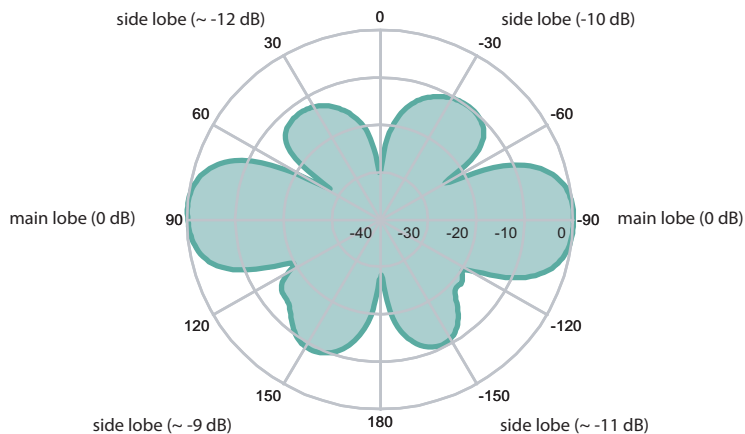
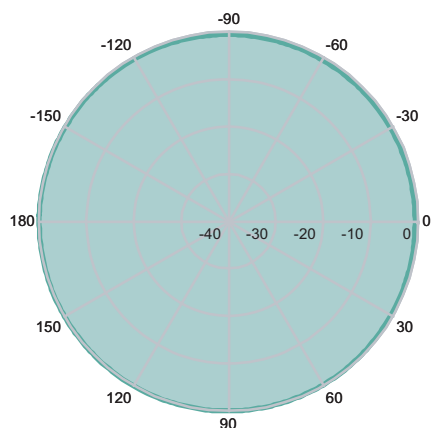

Table 74: Interpreting antenna diagrams

■ **Decibels (dB)**

The remaining output of an antenna at a specific angle is shown in negative decibels (dB) on the antenna diagram.

See “Interpreting antenna diagrams” on page 67.

How do you interpret the negative decibel values on the antenna diagram?

Definition dB:  $Q_{(P)} = 10 \times \lg_{10} P_1/P_2$  dB

The following table shows the attenuation in steps of -3 dB:

Attenuation in decibels	Remaining output
-3	1/2
-6	1/4
-9	1/8
-12	1/16

In antenna diagrams, circles are used to display the attenuation – usually in steps of 10:

Attenuation in decibels	Remaining output
-10	1/10
-20	1/100
-30	1/1000
-40	1/10 000

Example:

The above antenna diagram shows the output at -30° as -10 decibels.

[See “Interpreting antenna diagrams” on page 67.](#)

This means that the antenna transmits 1/10 of the maximum output at an angle of  $-30^\circ$ .

Example:

The above antenna diagram shows the output at  $150^\circ$  as  $-9$  decibels.

[See “Interpreting antenna diagrams” on page 67.](#)

This means that the antenna transmits 1/8 of the maximum output at an angle of  $150^\circ$ .

# C Index

## A

ATEX zone II 64

## F

FAQ 70

## R

Radiating cable 53

## T

Technical questions 70

Training courses 70

## D Further support

### Technical questions

For technical questions, please contact any Hirschmann dealer in your area or Hirschmann directly.

You find the addresses of our partners on the Internet at <http://www.hirschmann.com>.

A list of local telephone numbers and email addresses for technical support directly from Hirschmann is available at <https://hirschmann-support.belden.eu.com>.

This site also includes a free of charge knowledge base and a software download section.

### Hirschmann Competence Center

The Hirschmann Competence Center is ahead of its competitors on three counts with its complete range of innovative services:

- ▶ Consulting incorporates comprehensive technical advice, from system evaluation through network planning to project planning.
- ▶ Training offers you an introduction to the basics, product briefing and user training with certification.  
You find the training courses on technology and products currently available at <http://www.hicomcenter.com>.
- ▶ Support ranges from the first installation through the standby service to maintenance concepts.

With the Hirschmann Competence Center, you decided against making any compromises. Our client-customized package leaves you free to choose the service components you want to use.

Internet:

<http://www.hicomcenter.com>





**HIRSCHMANN**

---

A **BELDEN** BRAND