



HIRSCHMANN

A **BELDEN** BRAND

Hirschmann Automation and Control GmbH

RED HiOS-2S Rel. 07000

Reference Manuals

Graphical User Interface
Command Line Interface

User Manual

Configuration



HIRSCHMANN

A **BELDEN** BRAND

Reference Manual

Graphical User Interface HiOS-2S RED (Redundancy Switch)

The naming of copyrighted trademarks in this manual, even when not specially indicated, should not be taken to mean that these names may be considered as free in the sense of the trademark and tradename protection law and hence that they may be freely used by anyone.

© 2017 Hirschmann Automation and Control GmbH

Manuals and software are protected by copyright. All rights reserved. The copying, reproduction, translation, conversion into any electronic medium or machine scannable form is not permitted, either in whole or in part. An exception is the preparation of a backup copy of the software for your own use.

The performance features described here are binding only if they have been expressly agreed when the contract was made. This document was produced by Hirschmann Automation and Control GmbH according to the best of the company's knowledge. Hirschmann reserves the right to change the contents of this document without prior notice. Hirschmann can give no guarantee in respect of the correctness or accuracy of the information in this document.

Hirschmann can accept no responsibility for damages, resulting from the use of the network components or the associated operating software. In addition, we refer to the conditions of use specified in the license contract.

You can get the latest version of this manual on the Internet at the Hirschmann product site (www.hirschmann.com).

Hirschmann Automation and Control GmbH
Stuttgarter Str. 45-51
72654 Neckartenzlingen
Germany

Contents

| | |
|--|-----------|
| Safety instructions | 9 |
| About this Manual | 11 |
| Key | 13 |
| Notes on the graphical user interface | 15 |
| 1 Basic Settings | 19 |
| 1.1 System | 20 |
| 1.2 Network | 24 |
| 1.3 Software | 27 |
| 1.4 Load/Save | 29 |
| 1.5 External Memory | 38 |
| 1.6 Port | 41 |
| Configuration | 42 |
| Statistics | 46 |
| Utilization | 48 |
| 1.7 Restart | 49 |
| 2 Time | 51 |
| 2.1 Basic Settings | 52 |
| Global | 53 |
| Daylight saving time | 54 |
| 2.2 SNTP | 57 |
| 2.2.1 SNTP Client | 58 |
| 2.2.2 SNTP Server | 61 |
| 2.3 PTP | 63 |
| 2.3.1 PTP Global | 64 |
| 2.3.2 PTP Boundary Clock | 66 |
| 2.3.2.1 PTP Boundary Clock Global | 67 |
| 2.3.2.2 PTP Boundary Clock Port | 70 |
| 2.3.3 PTP Transparent Clock | 73 |
| 2.3.3.1 PTP Transparent Clock Global | 74 |
| 2.3.3.2 PTP Transparent Clock Port | 77 |
| 3 Device Security | 79 |
| 3.1 User Management | 80 |
| 3.2 Authentication List | 84 |
| 3.3 Management Access | 87 |
| 3.3.1 Server | 88 |
| Information | 89 |

| | |
|---|------------|
| SNMP | 91 |
| Telnet | 93 |
| SSH | 94 |
| HTTP | 97 |
| HTTPS | 98 |
| 3.3.2 IP Access Restriction | 101 |
| 3.3.3 Web | 104 |
| 3.3.4 Command Line Interface | 105 |
| Global | 106 |
| Login banner | 107 |
| 3.3.5 SNMPv1/v2 Community | 108 |
| 3.4 Pre-login Banner | 109 |
| 4 Network Security | 111 |
| 4.1 Port Security | 112 |
| Wizard : Port security | 115 |
| 4.2 802.1X Port Authentication | 117 |
| 4.2.1 802.1X Global | 118 |
| 4.2.2 802.1X Port Configuration | 120 |
| 4.2.3 802.1X Port Clients | 123 |
| 4.2.4 802.1X EAPOL Port Statistics | 124 |
| 4.2.5 802.1X Port Authentication History | 125 |
| 4.2.6 802.1X Integrated Authentication Server | 127 |
| 4.3 RADIUS | 128 |
| 4.3.1 RADIUS Global | 129 |
| 4.3.2 RADIUS Authentication Server | 130 |
| 4.3.3 RADIUS Accounting Server | 132 |
| 4.3.4 RADIUS Authentication Statistics | 133 |
| 4.3.5 RADIUS Accounting Statistics | 134 |
| 4.4 DoS | 135 |
| 4.4.1 DoS Global | 136 |
| 5 Switching | 139 |
| 5.1 Switching Global | 140 |
| 5.2 Rate Limiter | 142 |
| 5.3 Filter for MAC Addresses | 144 |
| 5.4 IGMP Snooping | 146 |
| 5.4.1 IGMP Snooping Global | 147 |
| 5.4.2 IGMP Snooping Configuration | 148 |
| VLAN ID | 149 |
| Port | 150 |
| 5.4.3 IGMP Snooping Enhancements | 152 |
| Wizard : Selection VLAN/Port | 154 |

| | | |
|-------|--|-----|
| 5.4.4 | IGMP Snooping Querier | 155 |
| 5.4.5 | IGMP Snooping Multicasts | 157 |
| 5.5 | MRP-IEEE | 158 |
| 5.5.1 | MRP-IEEE Configuration | 159 |
| 5.5.2 | MRP-IEEE Multiple MAC Registration Protocol | 160 |
| | Configuration | 161 |
| | Service requirement | 163 |
| | Statistics | 164 |
| 5.5.3 | MRP-IEEE Multiple VLAN Registration Protocol | 165 |
| | Configuration | 166 |
| | Statistics | 168 |
| 5.6 | QoS/Priority | 169 |
| 5.6.1 | QoS/Priority Global | 170 |
| 5.6.2 | QoS/Priority Port Configuration | 171 |
| 5.6.3 | 802.1D/p Mapping | 172 |
| 5.6.4 | IP DSCP Mapping | 173 |
| 5.6.5 | Queue Management | 175 |
| 5.7 | VLAN | 176 |
| 5.7.1 | VLAN Global | 177 |
| 5.7.2 | VLAN Configuration | 178 |
| 5.7.3 | VLAN Port | 180 |
| 5.7.4 | VLAN Voice | 181 |
| 5.8 | L2-Redundancy | 183 |
| 5.8.1 | MRP | 184 |
| 5.8.2 | DLR | 187 |
| | 5.8.2.1 DLR Configuration | 189 |
| | 5.8.2.2 DLR Statistics | 192 |
| | Status | 192 |
| | Participants | 194 |
| 5.8.3 | PRP | 195 |
| | 5.8.3.1 PRP Configuration | 196 |
| | 5.8.3.2 PRP DAN/VDAN Table | 199 |
| | 5.8.3.3 PRP Proxy Node Table | 200 |
| | 5.8.3.4 PRP Statistics | 201 |
| 5.8.4 | HSR | 202 |
| | 5.8.4.1 HSR Configuration | 203 |
| | 5.8.4.2 HSR DAN/VDAN Table | 206 |
| | 5.8.4.3 HSR Proxy Node Table | 207 |
| | 5.8.4.4 HSR Statistics | 208 |
| 5.8.5 | Spanning Tree | 209 |
| | 5.8.5.1 Spanning Tree Global | 210 |
| | 5.8.5.2 Spanning Tree Port | 215 |

| | | |
|----------|-------------------------------------|------------|
| | CIST | 216 |
| | Guards | 219 |
| 5.8.6 | Link Aggregation | 221 |
| 5.8.7 | Link Backup | 226 |
| 6 | Diagnostics | 229 |
| 6.1 | Status Configuration | 230 |
| 6.1.1 | Device Status | 231 |
| | Global | 232 |
| | Port | 234 |
| | Status | 235 |
| 6.1.2 | Security Status | 236 |
| | Global | 237 |
| | Port | 241 |
| | Status | 242 |
| 6.1.3 | Signal Contact | 243 |
| 6.1.3.1 | Signal Contact 1 / Signal Contact 2 | 244 |
| | Global | 245 |
| | Port | 248 |
| | Status | 249 |
| 6.1.4 | MAC Notification | 250 |
| 6.1.5 | Alarms (Traps) | 252 |
| 6.2 | System | 253 |
| 6.2.1 | System Information | 254 |
| 6.2.2 | Hardware State | 255 |
| 6.2.3 | Configuration Check | 256 |
| 6.2.4 | IP Address Conflict Detection | 258 |
| 6.2.5 | ARP | 261 |
| 6.2.6 | Selftest | 262 |
| 6.3 | Syslog | 264 |
| 6.4 | Ports | 266 |
| 6.4.1 | SFP | 267 |
| 6.4.2 | Port Monitor | 268 |
| | Global | 268 |
| | Auto-disable | 271 |
| | Link flap | 272 |
| | CRC/Fragments | 273 |
| | Overload detection | 274 |
| | Link speed/Duplex mode detection | 276 |
| 6.4.3 | Auto-Disable | 278 |
| | Port | 278 |
| | Status | 279 |

| | | |
|----------|--------------------------|------------|
| 6.4.4 | Port Mirroring | 281 |
| 6.5 | LLDP | 284 |
| 6.5.1 | LLDP Configuration | 285 |
| 6.5.2 | LLDP Topology Discovery | 288 |
| | LLDP | 289 |
| | LLDP-MED | 290 |
| 6.6 | Report | 291 |
| 6.6.1 | Report Global | 292 |
| 6.6.2 | Persistent Logging | 296 |
| 6.6.3 | System Log | 298 |
| 6.6.4 | Audit Trail | 299 |
| 7 | Advanced | 301 |
| 7.1 | DHCP Server | 302 |
| 7.1.1 | DHCP Server Global | 303 |
| 7.1.2 | DHCP Server Pool | 304 |
| 7.1.3 | DHCP Server Lease Table | 307 |
| 7.2 | Industrial Protocols | 308 |
| 7.2.1 | IEC61850-MMS | 309 |
| 7.2.2 | Modbus TCP | 311 |
| 7.2.3 | PROFINET | 313 |
| 7.2.4 | EtherNet/IP | 315 |
| A | Index | 317 |
| B | Further support | 319 |
| C | Readers' Comments | 320 |

Safety instructions

 **WARNING**

UNCONTROLLED MACHINE ACTIONS

To avoid uncontrolled machine actions caused by data loss, configure all the data transmission devices individually.

Before you start any machine which is controlled via data transmission, be sure to complete the configuration of all data transmission devices.

Failure to follow these instructions can result in death, serious injury, or equipment damage.

About this Manual

The “Installation” user manual contains a device description, safety instructions, a description of the display, and the other information that you need to install the device.

The “Configuration” user manual contains the information you need to start operating the device. It takes you step by step from the first startup operation through to the basic settings for operation in your environment.

The “Graphical User Interface” reference manual contains detailed information on using the graphical user interface to operate the individual functions of the device.

The “Command Line Interface” reference manual contains detailed information on using the Command Line Interface to operate the individual functions of the device.

The Industrial HiVision Network Management software provides you with additional options for smooth configuration and monitoring:

- ▶ Auto-topology discovery
- ▶ Browser interface
- ▶ Client/server structure
- ▶ Event handling
- ▶ Event log
- ▶ Simultaneous configuration of multiple devices
- ▶ Graphical user interface with network layout
- ▶ SNMP/OPC gateway

Key

The designations used in this manual have the following meanings:

| | |
|----------------------|--|
| ▶ | List |
| □ | Work step |
| ■ | Subheading |
| Link | Cross-reference with link |
| Note: | A note emphasizes an important fact or draws your attention to a dependency. |
| <code>Courier</code> | ASCII representation in the graphical user interface |

Notes on the graphical user interface

The graphical user interface of the device is divided as follows:

- ▶ [Navigation area](#)
- ▶ [Dialog area](#)
- ▶ [Buttons](#)

Navigation area

The Navigation area is located on the left side of the graphical user interface.

The Navigation area contains the following elements:





- ▶ [Toolbar](#)
- ▶ [Filter](#)
- ▶ [Menu](#)



You have the option of collapsing the entire Navigation area, for example when displaying the graphical user interface on small screens. To collapse or expand, you click the small arrow at the top of the navigation area.

■ Toolbar

The toolbar at the top of the navigation area contains several buttons.

- When you position the mouse pointer over a button, a tooltip displays further information.
- If the connection to the device is lost, the toolbar is grayed out.

| Button | Meaning |
|---|--|
|  | The device automatically refreshes the toolbar information every 5 seconds. Clicking the button refreshes the toolbar manually. |
|  | When you position the mouse pointer over the button, a tooltip displays the following information: <ul style="list-style-type: none"> ▶ <i>User:</i> Name of the logged in user ▶ <i>Device name:</i> Name of the device Clicking the button opens the <i>Device Security > User Management</i> dialog. |
|  | When you position the mouse pointer over the button, a tooltip displays the summary of the <i>Diagnostics > System > Configuration Check</i> dialog. Clicking the button opens the <i>Diagnostics > System > Configuration Check</i> dialog. |
|  | Clicking the button logs out the current user and displays the login page. |
|  | Displays the remaining time in seconds until the device automatically logs out an inactive user. Clicking the button opens the <i>Device Security > Management Access > Web</i> dialog. There you can specify the timeout. |

| Button | Meaning |
|---|--|
|  | <p>This button is visible if the configuration profile in the volatile memory (RAM) differs from the "Selected" configuration profile in the non-volatile memory (NVM). Otherwise, the button is hidden.</p> <p>Clicking the button opens the <i>Basic Settings > Load/Save</i> dialog.</p> <p>By right-clicking the button you can save the current settings in the non-volatile memory (NVM).</p> |
|  | <p>When you position the mouse pointer over the button, a tooltip displays the following information:</p> <ul style="list-style-type: none"> ▶ <i>Device Status</i>: This section displays a compressed view of the <i>Device status</i> frame in the <i>Basic Settings > System</i> dialog. The section displays the alarm that is currently active and whose occurrence was recorded first. ▶ <i>Security Status</i>: This section displays a compressed view of the <i>Security status</i> frame in the <i>Basic Settings > System</i> dialog. The section displays the alarm that is currently active and whose occurrence was recorded first. ▶ <i>Boot Parameter</i>: If you permanently save changes to the settings and at least one boot parameter differs from the configuration profile used during the last restart, then this section displays a note. <ul style="list-style-type: none"> The following settings cause the boot parameters to change: <ul style="list-style-type: none"> – <i>Basic Settings > External Memory</i> dialog, <i>Software auto update</i> parameter – <i>Basic Settings > External Memory</i> dialog, <i>Config priority</i> parameter – <i>Device Security > Management Access > Server</i> dialog, <i>SNMP tab, UDP port</i> parameter – <i>Diagnostics > System > Selftest</i> dialog, <i>RAM test</i> parameter – <i>Diagnostics > System > Selftest</i> dialog, <i>SysMon1 is available</i> parameter – <i>Diagnostics > System > Selftest</i> dialog, <i>Load default config on error</i> parameter <p>Clicking the button opens the <i>Diagnostics > Status Configuration > Device Status</i> dialog.</p> |

■ Filter

The filter enables you to reduce the number of menu items in the menu. When filtering, the menu displays only menu items matching the search string entered in the filter field.

■ Menu

The menu displays the menu items.

You have the option of filtering the menu items. See section [“Filter”](#).

To display the corresponding dialog in the dialog area, you click the desired menu item. If the selected menu item is a node containing sub-items, then the node expands or collapses while clicking. The dialog area keeps the previously displayed dialog.

You have the option of expanding or collapsing every node in the menu at the same time. When you right-click anywhere in the menu, a context menu displays the following entries:

- ▶ *Expand*
Expands every node in the menu at the same time. The menu displays the menu items for every level.
- ▶ *Collapse*
Collapses every node in the menu at the same time. The menu displays the top level menu items.

Dialog area



The Dialog area is located on the right side of the graphical user interface. When you click a menu item in the Navigation area, the Dialog area displays the corresponding dialog.

■ Updating the display

If a dialog remains opened for a longer time, then the values in the device have possibly changed in the meantime.

- To update the display in the dialog, click the  button. Unsaved information in the dialog is lost.

■ Saving the settings

- To transfer the changed settings to the volatile memory (RAM) of the device, click the  button.
- To keep the changed settings, even after restarting the device, proceed as follows:
 - Open the *Basic Settings > Load/Save* dialog.
 - In the table, highlight the desired configuration profile.
 - If in the *Selected* column the checkbox is unmarked, click the  button and then the *Select* item.
 - Click the  button and then the *Save* item.

Note: Unintentional changes to the settings may terminate the connection between your PC and the device. To keep the device accessible, enable the *Undo configuration modifications* function in the *Basic Settings > Load/Save* dialog, before changing any settings. Using the function, the device continuously checks whether it can still be reached from the IP address of the user's PC. If the connection is lost, the device loads the configuration profile saved in the non-volatile memory (NVM) after the specified time. Afterwards, the device can be accessed again.

■ Working with tables

The dialogs display numerous settings in table form.

When you modify a table cell, the table cell displays a red mark in its top-left corner. The red mark indicates that your modifications are not yet transferred to the volatile memory (RAM) of the device.

You have the option of customizing the look of the tables to fit your needs. When you position the mouse pointer over a column header, the column header displays a drop-down list button. When you click this button, the drop-down list displays the following entries:

- ▶ Sort ascending
 - Sorts the table entries in ascending order based on the entries of the selected column.
 - You recognize sorted table entries by an arrow in the column header.
- ▶ Sort descending
 - Sorts the table entries in descending order based on the entries of the selected column.
 - You recognize sorted table entries by an arrow in the column header.







- ▶ Columns
Displays or hides columns.
You recognize hidden columns by an unmarked checkbox in the drop-down list.
- ▶ Filters
The table only displays the entries whose content matches the specified filter criteria of the selected column.
You recognize filtered table entries by an emphasized column header.

You have the option of selecting multiple table entries simultaneously and subsequently applying an action to them. This is useful when you are going to remove multiple table entries at the same time.

- ▶ Select several consecutive table entries:
 - Click the first desired table entry to highlight it.
 - Press and hold the <SHIFT> key.
 - Click the last desired table entry to highlight every desired table entry.
- ▶ Select multiple individual table entries:
 - Click the first desired table entry to highlight it.
 - Press and hold the <CTRL> key.
 - Click the next desired table entry to highlight it.
Repeat until every desired table entry is highlighted.

Buttons

Here you find the description of the standard buttons. The special dialog-specific buttons are described in the corresponding dialog help text.

| Button | Meaning |
|---|---|
|  | Transfers the changes to the volatile memory (RAM) of the device and applies them to the device. To save the changes in the non-volatile memory, proceed as follows: <ul style="list-style-type: none"> <input type="checkbox"/> Open the <i>Basic Settings > Load/Save</i> dialog. <input type="checkbox"/> In the table, highlight the desired configuration profile. <input type="checkbox"/> If in the <i>Selected</i> column the checkbox is unmarked, click the  button and then the <i>Select</i> item. <input type="checkbox"/> Click the  button and then the <i>Save</i> item. |
|  | Updates the fields with the values that are saved in the volatile memory (RAM) of the device. |
|  | Adds a new table entry. |
|  | Removes the highlighted table entry. |
|  | Opens the online help. |

1 Basic Settings

The menu contains the following dialogs:

- ▶ System
- ▶ Network
- ▶ Software
- ▶ Load/Save
- ▶ External Memory
- ▶ Port
- ▶ Restart

1.1 System

In this dialog, you monitor individual operating statuses.

■ Device status

The fields in this frame display the device status and inform you about alarms that have occurred. When an alarm currently exists, the frame is highlighted.

You specify the parameters that the device monitors in the *Diagnostics > Status Configuration > Device Status* dialog.

| Parameters | Meaning |
|---|--|
| Alarm counter | Displays the number of currently existing alarms. |
|  | The icon is visible if there is at least one currently existing alarm. When you position the mouse pointer over the icon, a tooltip displays the cause of the currently existing alarms and the time at which the device triggered the alarm. The device triggers an alarm if a monitored parameter differs from the desired status. The <i>Diagnostics > Status Configuration > Device Status</i> dialog, <i>Status</i> tab displays an overview of the alarms. |

Note: The device reports an alarm if you connect one power supply unit exclusively for the supply voltage to a device with a redundant power supply unit. To avoid this alarm, you deactivate the monitoring of the missing power supply units in the *Diagnostics > Status Configuration > Device Status* dialog.

■ Security status

The fields in this frame display the security status and inform you about alarms that have occurred. When an alarm currently exists, the frame is highlighted.

You specify the parameters that the device monitors in the *Diagnostics > Status Configuration > Security Status* dialog.

| Parameters | Meaning |
|---|--|
| Alarm counter | Displays the number of currently existing alarms. |
|  | The icon is visible if there is at least one currently existing alarm. When you position the mouse pointer over the icon, a tooltip displays the cause of the currently existing alarms and the time at which the device triggered the alarm. The device triggers an alarm if a monitored parameter differs from the desired status. The <i>Diagnostics > Status Configuration > Security Status</i> dialog, <i>Status</i> tab displays an overview of the alarms. |

■ Signal contact status

The fields in this frame display the signal contact status and inform you about alarms that have occurred. When an alarm currently exists, the frame is highlighted.

You specify the parameters that the device monitors in the *Diagnostics > Status Configuration > Signal Contact > Signal Contact 1/Signal Contact 2* dialog.

| Parameters | Meaning |
|---|---|
| Alarm counter | Displays the number of currently existing alarms. |
|  | <p>The icon is visible if there is at least one currently existing alarm.</p> <p>When you position the mouse pointer over the icon, a tooltip displays the cause of the currently existing alarms and the time at which the device triggered the alarm.</p> <p>The device triggers an alarm if a monitored parameter differs from the desired status. The <i>Diagnostics > Status Configuration > Signal Contact > Signal Contact 1/Signal Contact 2</i> dialog, <i>Status</i> tab displays an overview of the alarms.</p> |

■ System data











The fields in this frame display operating data and information on the location of the device.

| Parameters | Meaning |
|----------------------------------|---|
| System name | <p>Specifies the name for which the device is known in the network.</p> <p>Possible values:</p> <ul style="list-style-type: none"> ▶ Alphanumeric ASCII character string with 0..255 characters The following characters are allowed: <ul style="list-style-type: none"> - 0..9 - a..z - A..Z - !#\$%&'()*+,-./:;<=>?@[\\]^_`{ }~ - <device name>-<MAC address> (default setting) <p>When creating HTTPS X.509 certificates, the application generating the certificate uses the specified value as the domain name and common name.</p> <p>The following functions use the specified value as a host name or FQDN (Fully Qualified Domain Name). For compatibility, it is recommended to use only small letters, since not every system compares the case in the FQDN. Verify that this name is unique in the whole network.</p> <ul style="list-style-type: none"> ▶ DHCP client ▶ <i>Syslog</i> ▶ <i>IEC61850-MMS</i> ▶ <i>PROFINET</i> <p>Note: For compatibility in PROFINET environments, specify the PROFINET device name. In PROFINET the name is limited to a maximum of 240 characters. Do not begin the name with a number. Programs read the device name using SNMP and PROFINET DCP.</p> |
| Location | <p>Specifies the location of the device.</p> <p>Possible values:</p> <ul style="list-style-type: none"> ▶ Alphanumeric ASCII character string with 0..255 characters |
| Contact person | <p>Specifies the contact person for this device.</p> <p>Possible values:</p> <ul style="list-style-type: none"> ▶ Alphanumeric ASCII character string with 0..255 characters |
| Device type | Displays the product name of the device. |
| Power supply 1 Power supply 2 | <p>Displays the status of the power supply unit on the relevant voltage supply connection.</p> <p>Possible values:</p> <ul style="list-style-type: none"> ▶ present ▶ defective ▶ notInstalled ▶ unknown |

| Parameters | Meaning |
|------------------------|--|
| Uptime | Displays the time that has elapsed since this device was last restarted. Possible values: ▶ Time in the format <code>day(s), ...h ...m ...s</code> |
| Temperature [°C] | Displays the current temperature in the device in °C. You activate the monitoring of the temperature thresholds in the <i>Diagnostics > Status Configuration > Device Status</i> dialog. |
| Upper temp. limit [°C] | Specifies the upper temperature threshold in °C. The “Installation” user manual contains detailed information about setting the temperature thresholds. Possible values: ▶ -99..99 (integer) If the temperature in the device exceeds this value, the device generates an alarm. |
| Lower temp. limit [°C] | Specifies the lower temperature threshold in °C. The “Installation” user manual contains detailed information about setting the temperature thresholds. Possible values: ▶ -99..99 (integer) If the temperature in the device falls below this value, the device generates an alarm. |

■ LED status







This frame displays the states of the device status LEDs at the time of the last update. The “Installation” user manual contains detailed information about the device status LEDs.

| Parameters | Color | Meaning |
|------------|---|--|
| Status |  | There is currently no device status alarm. The device status is OK. |
| |  | There is currently at least one device status alarm. Therefore, see the <i>Device status</i> frame above. |
| Power |  | Device variant with 2 power supply units: Only one supply voltage is active. |
| |  | Device variant with 1 power supply unit: The supply voltage is active. |
| |  | Device variant with 2 power supply units: Both supply voltages are active. |
| RM |  | The device is neither operating as a <i>MRP</i> ring manager nor as a <i>DLR</i> supervisor. |
| |  | Loss of redundancy reserve. The device is operating as a <i>MRP</i> ring manager. or The device is operating as a <i>DLR</i> supervisor. |
| |  | Redundancy reserve is available. The device is operating as a <i>MRP</i> ring manager. or The device is operating as a <i>DLR</i> supervisor. |
| ACA |  | No external memory connected. |
| |  | The external memory is connected, but not ready for operation. |
| |  | The external memory is connected and ready for operation. |

■ Port status

This frame displays a simplified view of the ports of the device at the time of the last update.

The icons represent the status of the individual ports. In some situations, the following icons interfere with one another. When you position the mouse pointer over the appropriate port icon, a tooltip displays a detailed information about the port state.

| Parameters | Status | Meaning |
|---------------|---|---|
| <Port number> |  | The port is inactive. The port does not send or receive any data. |
| |  | The port is inactive. The cable is connected. Active link. |
| |  | The port is active. No cable connected or no active link. |
| |  | The port is active. The cable is connected. Connection okay. Active link. Full-duplex mode |
| |  | The half-duplex mode is enabled. Verify the settings in the <i>Basic Settings > Ports</i> dialog, <i>Configuration</i> tab. |
| |  | The port is in a blocking state due to a redundancy function. |
| |  | The port operates as a router interface. |

■ Buttons

You find the description of the standard buttons in section [“Buttons” on page 18](#).

1.2 Network

This dialog allows you to specify the IP, VLAN and HiDiscovery settings required for the access to the device management through the network.

■ Management interface

This frame allows you to specify the following settings:

- ▶ The source from which the device management receives its IP parameters
- ▶ VLAN in which the management can be accessed

| Parameters | Meaning |
|-----------------------|--|
| IP address assignment | <p>Specifies the source from which the device receives its IP parameters after starting:</p> <p>Possible values:</p> <ul style="list-style-type: none">▶ Local The device uses the IP parameters from the internal memory. You specify the settings for this in the <i>IP parameter</i> frame.▶ BOOTP The device receives its IP parameters from a BOOTP or DHCP server. The server evaluates the MAC address of the device, then assigns the IP parameters.▶ DHCP (default setting) The device receives its IP parameters from a DHCP server. The server evaluates the MAC address, the DHCP name, or other parameters of the device, then assigns the IP parameters. <p>Note: If there is no response from the BOOTP or DHCP server, the device sets the IP address to 0.0.0.0 and makes another attempt to obtain a valid IP address.</p> |
| VLAN ID | <p>Specifies the VLAN in which the device management is accessible through the network. The device management is accessible through ports that are members of this VLAN.</p> <p>Possible values:</p> <ul style="list-style-type: none">▶ 1..4042 (default setting: 1) The prerequisite is that the VLAN is already configured. See the <i>Switching > VLAN > Configuration</i> dialog. <p>When you click the <input checked="" type="checkbox"/> button after changing the value, the <i>Information</i> window opens. Select the port, over which you connect to the device in the future. After clicking the <i>Ok</i> button, the new management VLAN settings are assigned to the port.</p> <ul style="list-style-type: none">– After that the port is a member of the VLAN and transmits the data packets without a VLAN tag (untagged). See the <i>Switching > VLAN > Configuration</i> dialog.– The device assigns the port VLAN ID of the management VLAN to the port. See the <i>Switching > VLAN > Port</i> dialog. <p>After a short time the device is reachable over the new port in the new management VLAN.</p> |
| MAC address | <p>Displays the MAC address of the device. The device management is accessible via the network using the MAC address.</p> |

■ BOOTP/DHCP

| Parameters | Meaning |
|------------|---|
| Client ID | <p>Displays the DHCP client ID that the device sends to the BOOTP or DHCP server. If the server is configured accordingly, it reserves an IP address for this DHCP client ID. Therefore, the device receives the same IP from the server every time it requests it.</p> <p>The DHCP client ID that the device sends is the device name specified in the <i>System name</i> field in the <i>Basic Settings > System</i> dialog.</p> |

■ HiDiscovery protocol v1/v2

This frame allows you to specify settings for the access to the device using the HiDiscovery protocol.

On a PC, the HiDiscovery software displays the Hirschmann devices that can be accessed in the network on which the HiDiscovery function is enabled. You can access these devices even if they have invalid or no IP parameters assigned. The HiDiscovery software allows you to assign or change the IP parameters in the device.

| Parameters | Meaning |
|------------|---|
| Operation | <p>Enables/disables the HiDiscovery function on the device.</p> <p>Possible values:</p> <ul style="list-style-type: none"> ▶ On (default setting) HiDiscovery is enabled. You can use the HiDiscovery software to access the device from your PC. ▶ Off HiDiscovery is disabled. |
| Access | <p>Enables/disables the write access to the device using HiDiscovery.</p> <p>Possible values:</p> <ul style="list-style-type: none"> ▶ readWrite (default setting) The HiDiscovery software is given write access to the device. With this setting you can change the IP parameters in the device. ▶ readOnly The HiDiscovery software is given read-only access to the device. With this setting you can view the IP parameters in the device. <p>Recommendation: Change the setting to <code>readOnly</code> exclusively after putting the device into operation.</p> |
| Signal | <p>Activates/deactivates the flashing of the port LEDs as does the function of the same name in the HiDiscovery software. The function allows you to identify the device in the field.</p> <p>Possible values:</p> <ul style="list-style-type: none"> ▶ marked The flashing of the port LEDs is active. The port LEDs flash until you disable the function again. ▶ unmarked (default setting) The flashing of the port LEDs is inactive. |

Note: With the HiDiscovery software you access the device through ports that are members of the same VLAN as the device management exclusively. You specify which VLAN a certain port is assigned to in the *Switching > VLAN > Configuration* dialog.

■ IP parameter

This frame allows you to assign the IP parameters manually. These fields can be edited if you have selected the `Local` radio button in the *Management interface* frame, *IP address assignment* option list.

| Parameters | Meaning |
|-----------------|---|
| IP address | Specifies the IP address under which the device management can be accessed through the network. Possible values: ▶ Valid IPv4 address |
| Netmask | Specifies the netmask. The netmask identifies the network prefix and the host address of the device in the IP address. Possible values: ▶ Valid IPv4 netmask |
| Gateway address | Specifies the IP address of a router through which the device accesses other devices outside its own network. Possible values: ▶ Valid IPv4 address |

■ Buttons

You find the description of the standard buttons in section [“Buttons” on page 18](#).

1.3 Software

This dialog allows you to update the device software and display information about the device software. You also have the option to restore a backup of the device software saved in the device.

Note: Before updating the device software, follow the version-specific notes in the `Readme` text file.

■ Version

| Parameters | Meaning |
|-----------------|---|
| Stored version | Displays the version number and creation date of the device software stored in the flash memory. The device loads the device software during the next restart. |
| Running version | Displays the version number and creation date of the device software that the device loaded during the last restart and is currently running. |
| Backup version | Displays the version number and creation date of the device software saved as a backup in the flash memory. The device copied this device software into the backup memory during the last software update or after you clicked the <i>Restore</i> button. |
| Restore | Restores the device software saved as a backup. In the process, the device changes the <i>Stored version</i> and the <i>Backup version</i> of the device software. Upon restart, the device loads the <i>Stored version</i> . |
| Bootcode | Displays the version number and creation date of the boot code. |

■ Software update

| Parameters | Meaning |
|------------|--|
| URL | <p>Specifies the path and the file name of the image file with which you update the device software.</p> <p>The device gives you the following options for updating the device software:</p> <ul style="list-style-type: none"> ▶ Software update from the PC <ul style="list-style-type: none"> If the file is located on your PC or on a network drive, drag and drop the file in the  area. Alternatively click in the area to select the file. ▶ Software update from an FTP server <ul style="list-style-type: none"> If the file is located on an FTP server, specify the URL for the file in the following form: <pre>ftp://<user>:<password>@<IP address>:<port>/<file name></pre> ▶ Software update from a TFTP server <ul style="list-style-type: none"> If the file is located on a TFTP server, specify the URL for the file in the following form: <pre>tftp://<IP address>/<path>/<file name></pre> ▶ Software update from an SCP or SFTP server <ul style="list-style-type: none"> If the file is located on an SCP or SFTP server, specify the URL for the file in one of the following forms: <ul style="list-style-type: none"> - <code>scp:// or sftp://<IP address>/<path>/<file name></code> When you click the <i>Start</i> button, the device displays the <i>Credentials</i> window. There you enter <i>User name</i> and <i>Password</i>, to log on to the server. - <code>scp:// or sftp://<user>:<password>@<IP address>/<path>/<file name></code> |
| Start | <p>Updates the device software.</p> <p>The device installs the selected file in the flash memory, replacing the previously saved device software. Upon restart, the device loads the installed device software.</p> <p>The device copies the existing software into the backup memory.</p> <p>To remain logged in to the device during the software update, move the mouse pointer occasionally. Alternatively, specify a sufficiently high value in the <i>Device Security > Management Access > Web</i> dialog, field <i>Web interface session timeout [min]</i> before the software update.</p> |

Alternatively, the device allows you to update the device software by right-clicking in the table if the image file is located in the external memory.

■ Table

| Parameters | Meaning |
|---------------|---|
| File location | Displays the storage location of the device software. Possible values: <ul style="list-style-type: none">▶ ram Volatile memory of the device▶ flash Non-volatile memory (NVM) of the device▶ usb External USB memory (ACA21/ACA22) |
| Index | Displays the index of the device software. For the device software in the flash memory, the index has the following meaning: <ul style="list-style-type: none">▶ 1 Upon restart, the device loads this device software.▶ 2 The device copied this device software into the backup area during the last software update. |
| File name | Displays the device-internal file name of the device software. |
| Firmware | Displays the version number and creation date of the device software. |

■ Buttons

You find the description of the standard buttons in section [“Buttons” on page 18](#).

1.4 Load/Save

This dialog allows you to save the device settings permanently in a configuration profile.

The device can hold several configuration profiles. When you activate an alternative configuration profile, you change to other device settings. You have the option of exporting the configuration profiles to your PC or to a server. You also have the option of importing the configuration profiles from your PC or from a server to the device.

In the default setting, the device saves the configuration profiles unencrypted. When you enter a password in the *Configuration encryption* frame, the device saves both the current and the future configuration profiles in an encrypted format.

Unintentional changes to the settings may terminate the connection between your PC and the device. To keep the device accessible, enable the *Undo configuration modifications* function before changing any settings. If the connection is lost, the device loads the configuration profile saved in the non-volatile memory (NVM) after the specified time.

■ External memory

| Parameters | Meaning |
|--------------------------|---|
| Selected external memory | <p>Displays the type of the external memory.</p> <p>Possible values:</p> <ul style="list-style-type: none"> ▶ usb External USB memory (ACA21/ACA22) |
| Status | <p>Displays the operating state of the external memory.</p> <p>Possible values:</p> <ul style="list-style-type: none"> ▶ notPresent No external memory connected. ▶ removed Someone has removed the external memory from the device during operation. ▶ ok The external memory is connected and ready for operation. ▶ outOfMemory The memory space is occupied on the external memory. ▶ genericErr The device has detected an error. |

■ Configuration encryption

| Parameters | Meaning |
|--------------|---|
| Active | <p>Displays whether the configuration encryption is active/inactive on the device.</p> <p>Possible values:</p> <ul style="list-style-type: none"> ▶ marked The configuration encryption is active. The device loads a configuration profile from the non-volatile memory (NVM) if it is encrypted and the password matches the password stored in the device. ▶ unmarked The configuration encryption is inactive. The device loads a configuration profile from the non-volatile memory solely (NVM) if it is unencrypted. <p>If in the <i>Basic Settings > External Memory</i> dialog, the <i>Config priority</i> column has the value <i>first</i> and the configuration profile is unencrypted, the <i>Security status</i> frame in the <i>Basic Settings > System</i> dialog displays an alarm.</p> <p>In the <i>Diagnostics > Status Configuration > Security Status</i> dialog, <i>Global</i> tab, <i>Monitor</i> column you specify whether the device monitors the <i>Load unencrypted config from external memory</i> parameter.</p> |
| Set password | <p>Opens the <i>Set password</i> window that helps you to enter the password needed for the configuration profile encryption. Encrypting the configuration profiles makes unauthorized access more difficult.</p> <ul style="list-style-type: none"> <input type="checkbox"/> When you are changing an existing password, enter the existing password in the <i>Old password</i> field. To display the password in plain text instead of ***** (asterisks), mark the <i>Display content</i> checkbox. <input type="checkbox"/> In the <i>New password</i> field, enter the password. To display the password in plain text instead of ***** (asterisks), mark the <i>Display content</i> checkbox. <input type="checkbox"/> Mark the <i>Save configuration afterwards</i> checkbox to use encryption also for the Selected configuration profile in the non-volatile memory (NVM) and in the external memory. <p>Note: Use this function solely if a maximum of 1 configuration profile is stored in the non-volatile memory (NVM) of the device. Before creating additional configuration profiles, decide for or against permanently activated configuration encryption in the device. Save additional configuration profiles either unencrypted or encrypted with the same password. If you are replacing a device with an encrypted configuration profile, for example due to a defect, you proceed as follows:</p> <ul style="list-style-type: none"> <input type="checkbox"/> Restart the new device and assign the IP parameters. <input type="checkbox"/> Open the <i>Basic Settings > Load/Save</i> dialog on the new device. <input type="checkbox"/> Encrypt the configuration profile in the new device. See above. Enter the same password you used in the defective device. <input type="checkbox"/> Install the external memory from the defective device in the new device. <input type="checkbox"/> Restart the new device. When it is restarted, the device loads the configuration profile with the settings of the defective device from the external memory. The device copies the settings into the volatile memory (RAM) and into the non-volatile memory (NVM). |
| Delete | <p>Opens the <i>Delete</i> window which helps you to cancel the configuration encryption in the device.</p> <ul style="list-style-type: none"> <input type="checkbox"/> In the <i>Old password</i> field, enter the existing password. To display the password in plain text instead of ***** (asterisks), mark the <i>Display content</i> checkbox. <input type="checkbox"/> Mark the <i>Save configuration afterwards</i> checkbox to remove the encryption also for the Selected configuration profile in the non-volatile memory (NVM) and in the external memory. <p>Note: If you keep additional encrypted configuration profiles in the memory, the device prevents you from activating or designating these configuration profiles as "Selected".</p> |

■ Information

| Parameters | Meaning |
|----------------------------------|---|
| NVM in sync with running config | <p>Displays whether the configuration profile in the volatile memory (RAM) and the "Selected" configuration profile in the non-volatile memory (NVM) are the same.</p> <p>Possible values:</p> <ul style="list-style-type: none"> ▶ marked The configuration profiles are the same. ▶ unmarked The configuration profiles differ. |
| External memory in sync with NVM | <p>Displays whether the "Selected" configuration profile in the external memory and the "Selected" configuration profile in the non-volatile memory (NVM) are the same.</p> <p>Possible values:</p> <ul style="list-style-type: none"> ▶ marked The configuration profiles are the same. ▶ unmarked The configuration profiles differ. <p>Possible causes:</p> <ul style="list-style-type: none"> – No external memory is connected to the device. – In the <i>Basic Settings > External Memory</i> dialog, the <i>Backup config when saving</i> function is disabled. |

■ Backup config on a remote server when saving





| Parameters | Meaning |
|------------|--|
| Operation | <p>Enables/disables the <i>Backup config on a remote server when saving</i> function.</p> <p>Possible values:</p> <ul style="list-style-type: none"> ▶ Enabled The <i>Backup config on a remote server when saving</i> function is enabled. When you save the configuration profile in the non-volatile memory (NVM), the device automatically backs up the configuration profile on the remote server specified in the <i>URL</i> field. ▶ Disabled (default setting) The <i>Backup config on a remote server when saving</i> function is disabled. |
| URL | <p>Specifies path and file name of the backed up configuration profile on the remote server.</p> <p>Possible values:</p> <ul style="list-style-type: none"> ▶ Alphanumeric ASCII character string with 0..128 characters Example: <code>tftp://192.9.200.1/cfg/config.xml</code> <p>The device supports the following wildcards:</p> <ul style="list-style-type: none"> – %d System date in the format YYYY-mm-dd – %t System time in the format HH_MM_SS – %i IP address of the device – %m MAC address of the device in the format AA-BB-CC-DD-EE-FF – %p Product name of the device |

| Parameters | Meaning |
|-----------------|---|
| Set credentials | <p>Opens the <i>Credentials</i> window which helps you to enter the credentials needed to authenticate on the remote server.</p> <ul style="list-style-type: none"> <input type="checkbox"/> In the <i>User name</i> field, enter the user name. To display the user name in plain text instead of ***** (asterisks), mark the <i>Display content</i> checkbox. Possible values: <ul style="list-style-type: none"> – Alphanumeric ASCII character string with 1..32 characters <input type="checkbox"/> In the <i>Password</i> field, enter the password. To display the password in plain text instead of ***** (asterisks), mark the <i>Display content</i> checkbox. Possible values: <ul style="list-style-type: none"> ▶ Alphanumeric ASCII character string with 6..64 characters The following characters are allowed: <pre>a..z A..Z 0..9 #\$%&'()*+,-./:;<=>?@_`</pre> |

■ Undo configuration modifications

| Parameters | Meaning |
|--|--|
| Operation | <p>Enables/disables the <i>Undo configuration modifications</i> function. Using the function, the device continuously checks whether it can still be reached from the IP address of the user's PC. If the connection is lost, after a specified time period the device loads the "Selected" configuration profile from the non-volatile memory (NVM). Afterwards, the device can be accessed again.</p> <p>Possible values:</p> <ul style="list-style-type: none"> ▶ On The function is enabled. <ul style="list-style-type: none"> – You specify the time period between the loss of the connection and the loading of the configuration profile in the field <i>Timeout [s] to recover after connection loss</i>. – If the non-volatile memory (NVM) contains multiple configuration profiles, the device loads the configuration profile designated as "Selected". ▶ Off (default setting) The function is disabled. Disable the function again before you close the graphical user interface. You thus prevent the device from restoring the configuration profile designated as "Selected". <p>Note: Before you enable the function, save the settings in the configuration profile. Current changes, that are saved temporarily, are therefore maintained in the device.</p> |
| Timeout [s] to recover after connection loss | <p>Specifies the time in seconds after which the device loads the "Selected" configuration profile from the non-volatile memory (NVM) if the connection is lost.</p> <p>Possible values:</p> <ul style="list-style-type: none"> ▶ 30..600 (default setting: 600) <p>Specify a sufficiently large value. Take into account the time when you are viewing the dialogs of the graphical user interface without changing or updating them.</p> |
| Watchdog IP address | <p>Displays the IP address of the PC on which you have enabled the function.</p> <p>Possible values:</p> <ul style="list-style-type: none"> ▶ IPv4 address (default setting: 0.0.0.0) |



■ **Table**

| Parameters | Meaning |
|-------------------------|---|
| Storage type | <p>Displays the storage location of the configuration profile.</p> <p>Possible values:</p> <ul style="list-style-type: none"> ▶ RAM (volatile memory of the device) In the volatile memory, the device stores the settings for the current operation. ▶ NVM (non-volatile memory of the device) From the non-volatile memory, the device loads the “Selected” configuration profile during a restart or when applying the function <i>Undo configuration modifications</i>. The non-volatile memory provides space for multiple configuration profiles, depending on the number of settings saved in the configuration profile. The device manages a maximum of 20 configuration profiles in the non-volatile memory. You can load a configuration profile into the volatile memory (RAM): <ul style="list-style-type: none"> <input type="checkbox"/> In the table, highlight the configuration profile. <input type="checkbox"/> Click the  button and then the <i>Activate</i> item. ▶ ENVM (external memory) On the external memory, the device saves a backup copy of the “Selected” configuration profile. The prerequisite is that in the <i>Basic Settings > External Memory</i> dialog you mark the <i>Backup config when saving</i> checkbox. |
| Profile name | <p>Displays the name of the configuration profile.</p> <p>Possible values:</p> <ul style="list-style-type: none"> ▶ running-config Name of the configuration profile in the volatile memory (RAM). ▶ config Name of the factory setting configuration profile in the non-volatile memory (NVM). ▶ User-defined name The device allows you to save a configuration profile with a user-specified name by highlighting an existing configuration profile in the table, clicking the  button and then the <i>Save As...</i> item. <p>To export the configuration profile as an XML file on your PC, click the link. Then you select the storage location and specify the file name.</p> <p>To save the file on a remote server, click the  button and then the <i>Export...</i> item.</p> |
| Modification date (UTC) | <p>Displays the time (UTC) at which a user last saved the configuration profile.</p> |
| Selected | <p>Displays whether the configuration profile is designated as “Selected”.</p> <p>Possible values:</p> <ul style="list-style-type: none"> ▶ marked The configuration profile is designated as “Selected”. <ul style="list-style-type: none"> – The device loads the configuration profile into the volatile memory (RAM) during a restart or when applying the function <i>Undo configuration modifications</i>. – When you click the  button, the device saves the temporarily saved settings in this configuration profile. ▶ unmarked Another configuration profile is designated as “Selected”. <p>To designate another configuration profile as “Selected”, you highlight the desired configuration profile in the table, click the  button and then the <i>Activate</i> item.</p> |
| Encrypted | <p>Displays whether the configuration profile is encrypted.</p> <p>Possible values:</p> <ul style="list-style-type: none"> ▶ marked The configuration profile is encrypted. ▶ unmarked The configuration profile is unencrypted. <p>You activate/deactivate the encryption of the configuration profile in the <i>Configuration encryption</i> frame.</p> |

| Parameters | Meaning |
|----------------------|---|
| Encryption verified | <p>Displays whether the password of the encrypted configuration profile matches the password stored in the device.</p> <p>Possible values:</p> <ul style="list-style-type: none"> ▶ marked The passwords match. The device is able to unencrypt the configuration profile. ▶ unmarked The passwords are different. The device is unable to unencrypt the configuration profile. |
| Software version | <p>Displays the version number of the device software that the device ran when it saved the configuration profile.</p> |
| Fingerprint | <p>Displays the checksum saved in the configuration profile. The device calculates the checksum when saving the settings and inserts it into the configuration profile.</p> |
| Fingerprint verified | <p>Displays whether the checksum saved in the configuration profile is valid.</p> <p>The device calculates the checksum of the configuration profile marked as "Selected" and compares it with the checksum saved in this configuration profile.</p> <p>Possible values:</p> <ul style="list-style-type: none"> ▶ marked The calculated and the saved checksum match. The saved settings are consistent. ▶ unmarked For the configuration profile marked as "Selected" applies: The calculated and the saved checksum are different. The configuration profile contains modified settings. Possible causes: <ul style="list-style-type: none"> – The file is damaged. – The file system on the external memory is inconsistent. – A user has exported the configuration profile and changed the XML file outside the device. For the other configuration profiles the device has not calculated the checksum. <p>The device verifies the checksum correctly only if the configuration profile has been saved before as follows:</p> <ul style="list-style-type: none"> – on an identical device – with the same software version, which the device is running <p>Note: This function identifies changes to the settings in the configuration profile. The function does not provide protection against operating the device with modified settings.</p> |

Buttons

You find the description of the standard buttons in section ["Buttons" on page 18](#).

| Button | Meaning |
|---|---|
|  | <p>Removes the configuration profile highlighted in the table from the non-volatile memory (NVM) or from the external memory.</p> <p>If the configuration profile is designated as "Selected", the device prevents you from removing the configuration profile.</p> |
|  | <p>Transfers the settings from the volatile memory (RAM) into the configuration profile designated as "Selected" in the non-volatile memory (NVM).</p> <p>If in the <i>Basic Settings > External Memory</i> dialog the checkbox in the <i>Backup config when saving</i> column is marked, the device generates a copy of the configuration profile on the external memory.</p> |

| Button | Meaning |
|---|--|
|  | Displays a sub menu with the following items. |
| Save As... | <p>Copies the configuration profile highlighted in the table and saves it with a user-specified name in the non-volatile memory (NVM). The device designates the new configuration profile as “Selected”.</p> <p>Note: Before creating additional configuration profiles, decide for or against permanently activated configuration encryption in the device. Save additional configuration profiles either unencrypted or encrypted with the same password.</p> <p>If in the <i>Basic Settings > External Memory</i> dialog the checkbox in the <i>Backup config when saving</i> column is marked, the device designates the configuration profile of the same name on the external memory as “Selected”.</p> |
| Activate | <p>Loads the settings of the configuration profile highlighted in the table to the volatile memory (RAM).</p> <ul style="list-style-type: none"> ▶ The device terminates the connection to the graphical user interface. <ul style="list-style-type: none"> <input type="checkbox"/> Reload the graphical user interface. <input type="checkbox"/> Login again. ▶ The device immediately uses the settings of the configuration profile on the fly. <p>Enable the <i>Undo configuration modifications</i> function before you activate another configuration profile. If the connection is lost afterwards, the device loads the last configuration profile designated as “Selected” from the non-volatile memory (NVM). The device can then be accessed again.</p> <p>If the configuration encryption is inactive, the device loads the configuration profile if it is unencrypted. If the configuration encryption is active, the device loads the configuration profile if it is encrypted and the password matches the password stored in the device.</p> <p>When you activate an older configuration profile, the device takes over the settings of the functions contained in this software version. The device sets the values of new functions to their default value.</p> |
| Select | <p>Designates the configuration profile highlighted in the table as “Selected”. In the <i>Selected</i> column, the checkbox is then marked.</p> <p>The device loads the settings of this configuration profile to the volatile memory (RAM) during a restart or when applying the function <i>Undo configuration modifications</i>.</p> <ul style="list-style-type: none"> ▶ Designate an unencrypted configuration profile only as “Selected” when the configuration encryption in the device is disabled. ▶ Designate an encrypted configuration profile only as “Selected” when the following prerequisites are fulfilled: <ul style="list-style-type: none"> – The configuration encryption in the device is enabled. – The password of the configuration profile matches the password saved in the device. <p>Otherwise, the device is unable to load and encrypt the settings in the configuration profile the next time it restarts. For this case you specify in the <i>Diagnostics > System > Selftest</i> dialog whether the device starts with the default settings or terminates the restart and stops.</p> <p>Note: You only mark the configuration profiles saved in the non-volatile memory (NVM).</p> <p>If in the <i>Basic Settings > External Memory</i> dialog the checkbox in the <i>Backup config when saving</i> column is marked, the device designates the configuration profile of the same name on the external memory as “Selected”.</p> |

| Button | Meaning |
|-----------|--|
| Import... | <p>Opens the <i>Import...</i> window to import a configuration profile. The prerequisite is that you have exported the configuration profile using the <i>Export...</i> button or using the link in the <i>Profile name</i> column.</p> <ul style="list-style-type: none"> <input type="checkbox"/> In the <i>Select source</i> drop-down list, select from where the device imports the configuration profile. <ul style="list-style-type: none"> ▶ PC/URL The device imports the configuration profile from the local PC or from a remote server. ▶ External memory The device imports the configuration profile from the external memory. <input type="checkbox"/> If PC/URL is selected above, then in the <i>Import profile from PC/URL</i> frame you specify the configuration profile file to be imported. <ul style="list-style-type: none"> – Import from the PC If the file is located on your PC or on a network drive, drag and drop the file in the  area. Alternatively click in the area to select the file. – Import from an FTP server If the file is located on an FTP server, specify the URL for the file in the following form: <code>ftp://<user>:<password>@<IP address>:<port>/<file name></code> – Import from a TFTP server If the file is located on a TFTP server, specify the URL for the file in the following form: <code>tftp://<IP address>/<path>/<file name></code> – Import from an SCP or SFTP server If the file is located on an SCP or SFTP server, specify the URL for the file in one of the following forms: <code>scp:// or sftp://<IP address>/<path>/<file name></code> When you click the <i>Start</i> button, the device displays the <i>Credentials</i> window. There you enter <i>User name</i> and <i>Password</i>, to log on to the server. <code>scp:// or sftp://<user>:<password>@<IP address>/<path>/<file name></code> <input type="checkbox"/> If External memory is selected above, then in the <i>Import profile from external memory</i> frame you specify the configuration profile file to be imported. In the <i>Profile name</i> drop-down list, select the name of the configuration profile to be imported. <input type="checkbox"/> In the <i>Destination</i> frame you specify where the device saves the imported configuration profile. In the <i>Profile name</i> field you specify the name under which the device saves the configuration profile. In the <i>Storage type</i> field you specify the storage location for the configuration profile. The prerequisite is that in the <i>Select source</i> drop-down list you have selected the value PC/URL. <ul style="list-style-type: none"> ▶ RAM The device saves the configuration profile in the volatile memory (RAM) of the device. This replaces the <code>running-config</code>, the device uses the settings of the imported configuration profile immediately. The device terminates the connection to the graphical user interface. Reload the graphical user interface. Login again. ▶ NVM The device saves the configuration profile in the non-volatile memory (NVM) of the device. <p>When you import a configuration profile, the device takes over the settings as follows:</p> <ul style="list-style-type: none"> – If the configuration profile was exported on the same device or on an identically equipped device of the same type: The device takes over the settings completely. – If the configuration profile was exported on an other device: The device takes over the settings which it can interpret based on its hardware equipment and software level. The remaining settings the device takes over from its <code>running-config</code> configuration profile. <p>Regarding configuration profile encryption, also read the help text of the <i>Configuration encryption</i> frame. The device imports a configuration profile under the following conditions:</p> <ul style="list-style-type: none"> – The configuration encryption of the device is inactive. The configuration profile is unencrypted. – The configuration encryption of the device is active. The configuration profile is encrypted with the same password that the device currently uses. |

| Button | Meaning |
|--------------------|--|
| Export... | <p>Exports the configuration profile highlighted in the table and saves it as an XML file on a remote server.</p> <p>To save the file on your PC, click the link in the <i>Profile name</i> column to select the storage location and specify the file name.</p> <p>The device gives you the following options for exporting a configuration profile:</p> <ul style="list-style-type: none"> ▶ Export to an FTP server To save the file on an FTP server, specify the URL for the file in the following form: ftp://<user>:<password>@<IP address>:<port>/<file name> ▶ Export to a TFTP server To save the file on a TFTP server, specify the URL for the file in the following form: tftp://<IP address>/<path>/<file name> ▶ Export to an SCP or SFTP server To save the file on an SCP or SFTP server, specify the URL for the file in one of the following forms: <ul style="list-style-type: none"> - scp:// or sftp://<IP address>/<path>/<file name> <p>When you click the <i>Ok</i> button, the device displays the <i>Credentials</i> window. There you enter <i>User name</i> and <i>Password</i>, to log on to the server.</p> <ul style="list-style-type: none"> - scp:// or sftp://<user>:<password>@<IP address>/<path>/<file name> |
| Back to factory... | <p>Resets the settings in the device to the default values.</p> <ul style="list-style-type: none"> ▶ The device deletes the saved configuration profiles from the volatile memory (RAM) and from the non-volatile memory (NVM). ▶ The device deletes the HTTPS certificate used by the web server in the device. ▶ The device deletes the DSA/RSA key (Host Key) used by the SSH server in the device. ▶ If an external memory is connected, the device deletes the configuration profiles saved on the external memory. ▶ After a brief period, the device reboots and loads the default values. |
| Back to default | Deletes the current operating (<i>running config</i>) settings from the volatile memory (RAM) . |

1.5 External Memory

This dialog allows you to activate functions that the device automatically executes in combination with the external memory. The dialog also displays the operating state and identifying characteristics of the external memory.

■ Configuration

| Parameters | Meaning |
|------------|--|
| USB mode | <p>Specifies the mode of communication between the device and the external memory. To activate the changes to this field, save the settings permanently and restart the device.</p> <p>Possible values:</p> <ul style="list-style-type: none">▶ <code>normal</code> (USB 2.0 mode) Device and external memory communicate in the high-speed mode (480 Mbit/s).▶ <code>compatibility</code> (USB 1.1 compatibility mode) Device and external memory communicate in the full-speed mode (12 Mbit/s). <p>Note: The external memory ACA21 operates in the USB 1.1 compatibility mode exclusively. If you use this external memory, specify the value <code>compatibility</code>.</p> |

■ Information

| Parameters | Meaning |
|------------------|--|
| Current USB mode | <p>Displays the mode the device currently uses for the communication with the external memory.</p> <p>Possible values:</p> <ul style="list-style-type: none">▶ <code>normal</code> (USB 2.0 mode) Device and external memory communicate in the high-speed mode (480 Mbit/s).▶ <code>compatibility</code> (USB 1.1 compatibility mode) Device and external memory communicate in the full-speed mode (12 Mbit/s). |

■ Table

| Parameters | Meaning |
|------------|--|
| Type | <p>Displays the type of the external memory.</p> <p>Possible values:</p> <ul style="list-style-type: none">▶ <code>usb</code> External USB memory (ACA21/ACA22) |
| Status | <p>Displays the operating state of the external memory.</p> <p>Possible values:</p> <ul style="list-style-type: none">▶ <code>notPresent</code> No external memory connected.▶ <code>removed</code> Someone has removed the external memory from the device during operation.▶ <code>ok</code> The external memory is connected and ready for operation.▶ <code>outOfMemory</code> The memory space is occupied on the external memory.▶ <code>genericErr</code> The device has detected an error. |

| Parameters | Meaning |
|---------------------------|--|
| Writable | <p>Displays whether the device has write access to the external memory.</p> <p>Possible values:</p> <ul style="list-style-type: none"> ▶ marked The device has write access to the external memory. ▶ unmarked The device has read-only access to the external memory. Possibly the write protection is activated on the external memory. |
| Software auto update | <p>Activates/deactivates the automatic device software update during the restart.</p> <p>Possible values:</p> <ul style="list-style-type: none"> ▶ marked (default setting) The automatic device software update during the restart is activated. The device updates the device software when the following files are located in the external memory: <ul style="list-style-type: none"> – the image file of the device software – a text file "startup.txt" with the content <code>autoUpdate=<image_file_name>.bin</code> ▶ unmarked The automatic device software update during the restart is deactivated. |
| SSH key auto upload | <p>Activates/deactivates the loading of the DSA/RSA key from an external memory upon restart.</p> <p>Possible values:</p> <ul style="list-style-type: none"> ▶ marked (default setting) The loading of the DSA/RSA key is activated. During a restart, the device loads the DSA/RSA key from the external memory when the following files are located on the external memory: <ul style="list-style-type: none"> – SSH RSA key file – SSH DSA key file – a text file "startup.txt" with the content <pre>autoUpdateRSA=<filename_of_the_SSH_RSA_key> autoUpdateDSA=<filename_of_the_SSH_DSA_key></pre> The device displays messages on the system console of the V.24 interface. ▶ unmarked The loading of the DSA/RSA key is deactivated. <p>Note: When loading the DSA/RSA key from the external memory (ENVM), the device overwrites the existing keys in the non-volatile memory (NVM).</p> |
| Config priority | <p>Specifies the memory from which the device loads the configuration profile upon reboot.</p> <p>Possible values:</p> <ul style="list-style-type: none"> ▶ disable The device loads the configuration profile from the non-volatile memory (NVM). ▶ first The device loads the configuration profile from the external memory. If the device does not find a configuration profile on the external memory, it loads the configuration profile from the non-volatile memory (NVM). <p>Note: When loading the configuration profile from the external memory (ENVM), the device overwrites the settings of the Selected configuration profile in the non-volatile memory (NVM).</p> <p>If the <i>Config priority</i> column has the value <i>first</i> and the configuration profile is unencrypted, the <i>Security status</i> frame in the <i>Basic Settings > System</i> dialog displays an alarm.</p> <p>In the <i>Diagnostics > Status Configuration > Security Status</i> dialog, <i>Global</i> tab, <i>Monitor</i> column you specify whether the device monitors the <i>Load unencrypted config from external memory</i> parameter.</p> |
| Backup config when saving | <p>Activates/deactivates creating a copy of the configuration profile on the external memory.</p> <p>Possible values:</p> <ul style="list-style-type: none"> ▶ marked (default setting) Creating a copy is activated. If you click in the <i>Basic Settings > Load/Save</i> dialog the <i>Save</i> button, the device generates a copy of the configuration profile on the active external memory. ▶ unmarked Creating a copy is deactivated. The device does not generate a copy of the configuration profile. |
| Manufacturer ID | Displays the name of the memory manufacturer. |
| Revision | Displays the revision number specified by the memory manufacturer. |

| Parameters | Meaning |
|---------------|---|
| Version | Displays the version number specified by the memory manufacturer. |
| Name | Displays the product name specified by the memory manufacturer. |
| Serial number | Displays the serial number specified by the memory manufacturer. |

■ **Buttons**

You find the description of the standard buttons in section [“Buttons” on page 18](#).

1.6 Port

This dialog allows you to specify settings for the individual ports. The dialog also displays the operating mode, connection status, bit rate and duplex mode for every port.

The dialog contains the following tabs:

- ▶ [\[Configuration\]](#)
- ▶ [\[Statistics\]](#)
- ▶ [\[Utilization\]](#)

[Configuration]

■ Table

| Parameters | Meaning |
|------------------------|---|
| Port | Displays the port number. |
| Name | <p>Name of the port.</p> <p>Possible values:</p> <ul style="list-style-type: none"> ▶ Alphanumeric ASCII character string with 0..64 characters The following characters are allowed: <ul style="list-style-type: none"> - <space> - 0..9 - a..z - A..Z - !#\$%&'()*+,-./:;<=>?@[\\]^_`{ }~ |
| Port on | <p>Activates/deactivates the port.</p> <p>Possible values:</p> <ul style="list-style-type: none"> ▶ <code>marked</code> (default setting) The port is active. ▶ <code>unmarked</code> The port is inactive. The port does not send or receive any data. |
| State | <p>Displays whether the port is currently physically enabled or disabled.</p> <p>Possible values:</p> <ul style="list-style-type: none"> ▶ <code>marked</code> The port is physically enabled. ▶ <code>unmarked</code> The port is physically disabled. If the <i>Port on</i> function is active, the <i>Auto-Disable</i> function has disabled the port. You specify the settings of the <i>Auto-Disable</i> function in the <i>Diagnostics > Ports > Auto-Disable</i> dialog. |
| Power state (port off) | <p>Specifies, whether the port is physically switched on or off when you deactivate the port with the <i>Port on</i> function.</p> <p>Possible values:</p> <ul style="list-style-type: none"> ▶ <code>marked</code> The port remains physically enabled. A connected device receives an active link. ▶ <code>unmarked</code> (default setting) The port is physically disabled. |
| Auto power down | <p>Specifies how the port behaves when no cable is connected.</p> <p>Possible values:</p> <ul style="list-style-type: none"> ▶ <code>no-power-save</code> (default setting) The port remains activated. ▶ <code>auto-power-down</code> The port changes to the energy-saving mode. ▶ <code>unsupported</code> The port does not support this function and remains activated. |

| Parameters | Meaning |
|-------------------------|--|
| Automatic configuration | <p>Activates/deactivates the automatic selection of the operating mode for the port.</p> <p>Possible values:</p> <ul style="list-style-type: none"> ▶ marked (default setting) The automatic selection of the operating mode is active. The port negotiates the operating mode independently using autonegotiation and detects the devices connected to the TP port automatically (Auto Cable Crossing). This setting has priority over the manual setting of the port. Elapse several seconds until the port has set the operating mode. ▶ unmarked The automatic selection of the operating mode is inactive. The port operates with the values you specify in the <i>Manual configuration</i> column and in the <i>Manual cable crossing (Auto. conf. off)</i> column. ▶ Grayed-out display No automatic selection of the operating mode. |
| Manual configuration | <p>Specifies the operating mode of the ports when the <i>Automatic configuration</i> function is disabled.</p> <p>Possible values:</p> <ul style="list-style-type: none"> ▶ 10 Mbit/s HDX Half duplex connection ▶ 10 Mbit/s FDX Full duplex connection ▶ 100 Mbit/s HDX Half duplex connection ▶ 100 Mbit/s FDX Full duplex connection ▶ 1000 Mbit/s FDX Full duplex connection ▶ 2500 Mbit/s FDX Full duplex connection <p>Note: The operating modes of the port actually available depend on the device configuration.</p> |
| Link/Current settings | <p>Displays the operating mode which the port currently uses.</p> <p>Possible values:</p> <ul style="list-style-type: none"> ▶ - No cable connected, no link. ▶ 10 Mbit/s HDX Half duplex connection ▶ 10 Mbit/s FDX Full duplex connection ▶ 100 Mbit/s HDX Half duplex connection ▶ 100 Mbit/s FDX Full duplex connection ▶ 1000 Mbit/s FDX Full duplex connection ▶ 2500 Mbit/s FDX Full duplex connection <p>Note: The operating modes of the port actually available depend on the device configuration.</p> |

| Parameters | Meaning |
|---|---|
| Manual cable crossing (Auto. conf. off) | <p>Specifies the devices connected to a TP port. The prerequisite is that the <i>Automatic configuration</i> function is disabled.</p> <p>Possible values:</p> <ul style="list-style-type: none"> ▶ mdi The device interchanges the send- and receive-line pairs on the port. ▶ mdix (default setting on TP ports) The device prevents the interchange of the send- and receive-line pairs on the port. ▶ auto-mdix The device detects the send and receive line pairs of the connected device and automatically adapts to them. Example: When you connect an end device with a crossed cable, the device automatically resets the port from mdix to mdi. ▶ unsupported (default setting on optical ports or TP-SFP ports) The port does not support this function. |
| Flow control | <p>Activates/deactivates the flow control on the port.</p> <p>Possible values:</p> <ul style="list-style-type: none"> ▶ marked (default setting) The Flow control on the port is active. The sending and evaluating of pause packets (full-duplex operation) or collisions (half-duplex operation) is activated on the port. <ul style="list-style-type: none"> <input type="checkbox"/> To enable the flow control in the device, also activate the <i>Flow control</i> function in the <i>Switching > Global</i> dialog. <input type="checkbox"/> Activate the flow control also on the port of the device that is connected to this port. On an uplink port, activating the flow control can possibly cause undesired sending breaks in the higher-level network segment ("wandering backpressure"). ▶ unmarked The Flow control on the port is inactive. <p>When you are using a redundancy function, you deactivate the flow control on the participating ports. If the flow control and the redundancy function are active at the same time, there is a risk that the redundancy function will not operate as intended.</p> |
| Send trap (Link up/down) | <p>Activates/deactivates the sending of SNMP traps when the device detects changes in the link up/down status for this port.</p> <p>Possible values:</p> <ul style="list-style-type: none"> ▶ marked (default setting) The sending of SNMP traps is active. The device sends an SNMP trap when it detects a link up/down status change. ▶ unmarked The sending of SNMP traps is inactive. <p>The prerequisite for sending SNMP traps is that you enable the function in the <i>Diagnostics > Status Configuration > Alarms (Traps)</i> dialog and specify at least 1 trap destination.</p> |
| Signal | <p>Activates/deactivates the port LED flashing. This function allows you to identify the port in the field.</p> <p>Possible values:</p> <ul style="list-style-type: none"> ▶ marked The flashing of the port LED is active. The port LED flashes until you disable the function again. ▶ unmarked (default setting) The flashing of the port LED is inactive. |
| Link monitoring | <p>Activates/deactivates the <i>Link monitoring</i> function on the interface. Use the <i>Link monitoring</i> function for end devices that do not support Far End Fault Indication (FEFI) on optical links.</p> <p>Possible values:</p> <ul style="list-style-type: none"> ▶ marked The <i>Link monitoring</i> function is active. If the device recognizes an established link, the port LED illuminates. When the device recognizes that a link has been lost, the port LED extinguishes. ▶ unmarked (default setting) The <i>Link monitoring</i> function is inactive. |

■ Buttons

You find the description of the standard buttons in section [“Buttons” on page 18](#).

| Button | Meaning |
|---|--|
|  | Displays a sub menu with the following items. |
| Clear port statistics | Resets the counter for the port statistics to 0. |

[Statistics]

This tab displays the following overview per port:

- ▶ Number of data packets/bytes received on the device
 - *Received packets*
 - *Received octets*
 - *Received unicast packets*
 - *Received multicast packets*
 - *Received broadcast packets*
- ▶ Number of data packets/bytes sent from the device
 - *Transmitted packets*
 - *Transmitted octets*
 - *Transmitted unicast packets*
 - *Transmitted multicast packets*
 - *Transmitted broadcast packets*
- ▶ Number of errors detected by the device
 - *Received fragments*
 - *Detected CRC errors*
 - *Detected collisions*
- ▶ Number of data packets per size category received on and sent from the device
 - *Packets 64 bytes*
 - *Packets 65 to 127 bytes*
 - *Packets 128 to 255 bytes*
 - *Packets 256 to 511 bytes*
 - *Packets 512 to 1023 bytes*
 - *Packets 1024 to 1518 bytes*
- ▶ Number of data packets discarded by the device
 - *Received discards*
 - *Transmitted discards*

To sort the table by a specific criterion click the header of the corresponding row.

For example, to sort the table based on the number of received bytes in ascending order, click the header of the *Received octets* column once. To sort in descending order, click the header again.

To reset the counter for the port statistics in the table to 0, proceed as follows:

- ▶ In the *Basic Settings > Port* dialog, click the  button and then the *Clear port statistics* item.
or
- ▶ In the *Basic Settings > Restart* dialog, click the *Clear port statistics* button.

■ Buttons

You find the description of the standard buttons in section [“Buttons” on page 18](#).

| Button | Meaning |
|---|--|
|  | Displays a sub menu with the following items. |
| Clear port statistics | Resets the counter for the port statistics to 0. |

[Utilization]

This tab displays the utilization (network load) for the individual ports.

■ Table

| Parameters | Meaning |
|----------------------|---|
| Port | Displays the port number. |
| Utilization [%] | Displays the current utilization in percent in relation to the time interval specified in the <i>Control interval [s]</i> column. The utilization is the relationship of the received data quantity to the maximum possible data quantity at the currently configured data rate. |
| Lower threshold [%] | Specifies a lower threshold for the utilization. If the utilization of the port falls below this value, the <i>Alarm</i> column displays an alarm. Possible values: ▶ 0.00..100.00 (default setting: 0.00) The value 0 deactivates the lower threshold. |
| Upper threshold [%] | Specifies an upper threshold for the utilization. If the utilization of the port exceeds this value, the <i>Alarm</i> column displays an alarm. Possible values: ▶ 0.00..100.00 (default setting: 0.00) The value 0 deactivates the upper threshold. |
| Control interval [s] | Specifies the interval in seconds. Possible values: ▶ 1..3600 (default setting: 30) |
| Alarm | Displays the utilization alarm status. Possible values: ▶ marked The utilization of the port is below the value specified in the <i>Lower threshold [%]</i> column or above the value specified in the <i>Upper threshold [%]</i> column. The device sends an SNMP trap. ▶ unmarked The utilization of the port is above the value specified in the <i>Lower threshold [%]</i> column and below the value specified in the <i>Upper threshold [%]</i> column. The prerequisite for sending SNMP traps is that you enable the function in the <i>Diagnostics > Status Configuration > Alarms (Traps)</i> dialog and specify at least 1 trap destination. |

■ Buttons

You find the description of the standard buttons in section “Buttons” on page 18.

| Button | Meaning |
|---|--|
|  | Displays a sub menu with the following items. |
| Clear port statistics | Resets the counter for the port statistics to 0. |

1.7 Restart

This dialog allows you to restart the device, reset port counters and address tables, and delete log files.

■ Restart

| Parameters | Meaning |
|---------------|---|
| Restart in | Displays the remaining time until the device restarts. To update the display of the remaining time, click the  button. |
| Cancel | Aborts a delayed restart. |
| Cold start... | <p>Opens the <i>Restart</i> dialog to initiate an immediate or delayed restart of the device.</p> <p>If the configuration profile in the volatile memory (RAM) and the "Selected" configuration profile in the non-volatile memory (NVM) differ, the device displays the <i>Warning</i> dialog.</p> <ul style="list-style-type: none"> <input type="checkbox"/> To permanently save the changes, click the <i>Yes</i> button in the <i>Warning</i> dialog. <input type="checkbox"/> To discard the changes, click <i>No</i> in the <i>Warning</i> dialog. <p>▶ In the <i>Restart in</i> field you specify the delay time for the delayed restart. Possible values: – 00:00:00..596:31:23 (default setting: 00:00:00)</p> <p>When the delay time elapsed, the device restarts and goes through the following phases:</p> <ul style="list-style-type: none"> ▶ The device performs a RAM test if this function is activated in the <i>Diagnostics > System > Selftest</i> dialog. ▶ The device starts the device software that the <i>Stored version</i> field displays in the <i>Basic Settings > Software</i> dialog. ▶ The device loads the settings from the "Selected" configuration profile. See the <i>Basic Settings > Load/Save</i> dialog. <p>Note: During the restart, the device does not transfer any data. During this time, the device cannot be accessed by the graphical user interface or other management systems.</p> |

■ Buttons

You find the description of the standard buttons in section [“Buttons” on page 18](#).

| Button | Meaning |
|----------------------------|--|
| Reset MAC address table | Removes the MAC addresses from the forwarding table that have in the <i>Switching > Filter for MAC Addresses</i> dialog the value <i>learned</i> in the <i>Status</i> column. |
| Reset ARP table | Removes the dynamically set up addresses from the ARP table. See the <i>Diagnostics > System > ARP</i> dialog. |
| Clear port statistics | Resets the counter for the port statistics to 0. See the <i>Basic Settings > Port</i> dialog, <i>Statistics</i> tab. |
| Reset IGMP snooping data | Removes the IGMP Snooping entries and resets the counter in the <i>Information</i> frame to 0. See the <i>Switching > IGMP Snooping > Global</i> dialog. |
| Delete log file | Removes the logged events from the log file. See the <i>Diagnostics > Report > System Log</i> dialog. |
| Delete persistent log file | Removes the log files from the external memory. See the <i>Diagnostics > Report > Persistent Logging</i> dialog. |

2 Time

The menu contains the following dialogs:

- ▶ [Basic Settings](#)
- ▶ [SNTP](#)
- ▶ [PTP](#)

2.1 Basic Settings

The device is equipped with a buffered hardware clock. This clock maintains the correct time if the power supply fails or you disconnect the device from the power supply. After the device is started, the current time is available to you, for example for log entries.

The hardware clock bridges a power supply downtime of 3 hours. The prerequisite is that the power supply of the device has been connected continually for at least 5 minutes beforehand.

In this dialog, you specify time-related settings independently of the time synchronization protocol specified.

The dialog contains the following tabs:

- ▶ [\[Global \]](#)
- ▶ [\[Daylight saving time \]](#)

[Global]

In this tab, you specify the system time in the device and the time zone.

■ Configuration

| Parameters | Meaning |
|--------------------|---|
| System time (UTC) | Displays the current date and time with reference to Universal Time Coordinated (UTC). |
| Set time from PC | The device uses the time on the PC as the system time. |
| System time | Displays the current date and time with reference to the local time: $System\ time = System\ time\ (UTC) + Local\ offset\ [min] + Daylight\ saving\ time$ |
| Time source | <p>Displays the time source from which the device gets the time information. The device automatically selects the available time source with the greatest accuracy.</p> <p>Possible values:</p> <ul style="list-style-type: none"> ▶ local System clock of the device. ▶ sntp The SNTP client is activated and the device is synchronized by an SNTP server. ▶ ptp PTP is activated and the clock of the device is synchronized with a PTP master clock. |
| Local offset [min] | <p>Specifies the difference between the local time and $System\ time\ (UTC)$ in minutes: $Local\ offset\ [min] = System\ time - System\ time\ (UTC)$</p> <p>Possible values:</p> <ul style="list-style-type: none"> ▶ -780..840 (default setting: 60) |

■ Buttons

You find the description of the standard buttons in section [“Buttons” on page 18](#).

[Daylight saving time]

In this tab, you activate the automatic daylight saving time function. You specify the beginning and the end of summertime using a pre-defined profile, or you specify these settings individually. During summertime, the device puts the local time forward by 1 hour.

■ Operation

| Parameters | Meaning |
|----------------------|--|
| Daylight saving time | Enables/disables the <i>Daylight saving time</i> mode. Possible values: <ul style="list-style-type: none">▶ On The <i>Daylight saving time</i> mode is enabled. The device automatically changes between summertime and wintertime.▶ Off (default setting) The <i>Daylight saving time</i> mode is disabled. The times at which the device changes between summertime and wintertime are specified in the <i>Summertime begin</i> and <i>Summertime end</i> frames. |
| Profile... | Displays the <i>Profile...</i> dialog. There you select a pre-defined profile for the beginning and the end of summertime. This profile overwrites the settings in the <i>Summertime begin</i> and <i>Summertime end</i> frames. |

■ Summertime begin

In the first 3 fields you specify the day for the beginning of summertime, and in the last field the time. The devices switches to summertime when the time in the *System time* field reaches the value entered here.

| Parameters | Meaning |
|------------|--|
| Week | Specifies the week in the current month. Possible values: <ul style="list-style-type: none">▶ none (default setting)▶ first▶ second▶ third▶ fourth▶ last |
| Day | Specifies the day of the week. Possible values: <ul style="list-style-type: none">▶ none (default setting)▶ Sunday▶ Monday▶ Tuesday▶ Wednesday▶ Thursday▶ Friday▶ Saturday |

| Parameters | Meaning |
|-------------|--|
| Month | <p>Specifies the month.</p> <p>Possible values:</p> <ul style="list-style-type: none"> ▶ none (default setting) ▶ January ▶ February ▶ March ▶ April ▶ May ▶ June ▶ July ▶ August ▶ September ▶ October ▶ November ▶ December |
| System time | <p>Specifies the time.</p> <p>Possible values:</p> <ul style="list-style-type: none"> ▶ <HH:MM> (default setting: 00:00) |

■ Summertime end

In the first 3 fields you specify the day for the end of summertime, and in the last field the time.

The devices switches to wintertime when the time in the *System time* field reaches the value entered here.

| Parameters | Meaning |
|------------|--|
| Week | <p>Specifies the week in the current month.</p> <p>Possible values:</p> <ul style="list-style-type: none"> ▶ none (default setting) ▶ first ▶ second ▶ third ▶ fourth ▶ last |
| Day | <p>Specifies the day of the week.</p> <p>Possible values:</p> <ul style="list-style-type: none"> ▶ none (default setting) ▶ Sunday ▶ Monday ▶ Tuesday ▶ Wednesday ▶ Thursday ▶ Friday ▶ Saturday |

| Parameters | Meaning |
|-------------|---|
| Month | Specifies the month. Possible values: <ul style="list-style-type: none">▶ none (default setting)▶ January▶ February▶ March▶ April▶ May▶ June▶ July▶ August▶ September▶ October▶ November▶ December |
| System time | Specifies the time. Possible values: <ul style="list-style-type: none">▶ <HH:MM> (default setting: 00:00) |

■ Buttons

You find the description of the standard buttons in section [“Buttons” on page 18](#).

2.2 SNTP

The Simple Network Time Protocol (SNTP) is a procedure described in the RFC 4330 for time synchronization in the network.

The device allows you to synchronize the system time in the device as an SNTP client. As the SNTP server, the device makes the time information available to other devices.

The menu contains the following dialogs:

- ▶ [SNTP Client](#)
- ▶ [SNTP Server](#)

2.2.1 SNTP Client

In this dialog, you specify the settings with which the device operates as an SNTP client.

As an SNTP client the device obtains the time information from both SNTP servers and NTP servers and synchronizes the local clock with the time of the time server.

■ Operation

| Parameters | Meaning |
|------------|--|
| Operation | Enables/disables the <i>SNTP Client</i> function of the device. Possible values: <ul style="list-style-type: none">▶ On The <i>SNTP Client</i> function is enabled. The device operates as an SNTP client.▶ Off (default setting) The <i>SNTP Client</i> function is disabled. |

■ Configuration

| Parameters | Meaning |
|--------------------------------------|---|
| Mode | Specifies whether the device actively requests the time information from an SNTP server known and configured in the network (Unicast mode) or passively waits for the time information from a random SNTP server (Broadcast mode). Possible values: <ul style="list-style-type: none">▶ unicast (default setting) The device takes the time information from the configured SNTP server exclusively. The device sends Unicast requests to the SNTP server and evaluates its responses.▶ broadcast The device obtains the time information from one or more SNTP or NTP servers. The device evaluates the Broadcasts or Multicasts from these servers exclusively. |
| Request interval [s] | Specifies the interval in seconds at which the device requests time information from the SNTP server. Possible values: <ul style="list-style-type: none">▶ 5..3600 (default setting: 30) |
| Broadcast recv timeout [s] | Specifies the time in seconds a client in broadcast client mode waits before changing the value in the field from <code>syncToRemoteServer</code> to <code>notSynchronized</code> when the client receives no broadcast packets. Possible values: <ul style="list-style-type: none">▶ 128..2048 (default setting: 320) |
| Disable client after successful sync | Activates/deactivates the disabling of the SNTP client after the device has successfully synchronized the time. Possible values: <ul style="list-style-type: none">▶ marked The disabling of the SNTP client is active. The device deactivates the SNTP client after successful time synchronization.▶ unmarked (default setting) The disabling of the SNTP client is inactive. The SNTP client remains active after successful time synchronization. |

■ State

| Parameters | Meaning |
|------------|--|
| State | <p>Displays the status of the SNTP client.</p> <p>Possible values:</p> <ul style="list-style-type: none"> ▶ disabled The SNTP client is disabled. ▶ notSynchronized The SNTP client is not synchronized with any SNTP or NTP server. ▶ synchronizedToRemoteServer The SNTP client is synchronized with an SNTP or NTP server. |

■ Table

In the table you specify the settings for up to 4 SNTP servers.

| Parameters | Meaning |
|----------------------|--|
| Index | <p>Displays the index number to which the table entry relates.</p> <p>Possible values:</p> <ul style="list-style-type: none"> ▶ 1..4 <p>The device automatically assigns this number. When you delete a table entry, this leaves a gap in the numbering. When you create a new table entry, the device fills the first gap.</p> <p>After starting, the device sends requests to the SNTP server configured in the first table entry. If the server does not reply, the device sends its requests to the SNTP server configured in the next table entry.</p> <p>If none of the configured SNTP servers responds in the meantime, the SNTP client loses its synchronization. The device cyclically sends requests to each SNTP server until a server delivers a valid time. The device synchronizes itself with this SNTP server, even if the other servers can be reached again later.</p> |
| Name | <p>Specifies the name of the SNTP server.</p> <p>Possible values:</p> <ul style="list-style-type: none"> ▶ Alphanumeric ASCII character string with 1..32 characters |
| Address | <p>Specifies the IP address of the SNTP server.</p> <p>Possible values:</p> <ul style="list-style-type: none"> ▶ Valid IPv4 address (default setting: 0.0.0.0) |
| Destination UDP port | <p>Specifies the UDP Port on which the SNTP server expects the time information.</p> <p>Possible values:</p> <ul style="list-style-type: none"> ▶ 1..65535 (default setting: 123) Exception: Port 2222 is reserved for internal functions. |

| Parameters | Meaning |
|------------|--|
| Status | <p>Displays the connection status between the SNTP client and the SNTP server.</p> <p>Possible values:</p> <ul style="list-style-type: none">▶ success The device has successfully synchronized the time with the SNTP server.▶ badDateEncoded The time information received contains protocol errors - synchronization failed.▶ other<ul style="list-style-type: none">– The value 0.0.0.0 is entered for the IP address of the SNTP server - synchronization failed.or– The SNTP client is using a different SNTP server.▶ requestTimedOut The device has not received a reply from the SNTP server - synchronization failed.▶ serverKissOfDeath The SNTP server is overloaded. The device is requested to synchronize itself with another SNTP server. If no other SNTP server is available, the device asks at intervals longer than the setting in the <i>Request interval [s]</i> field, whether the server is still overloaded.▶ serverUnsynchronized The SNTP server is not synchronized with either a local or an external reference clock - synchronization failed.▶ versionNotSupported The SNTP versions on the client and the server are incompatible with each other - synchronization failed. |
| Active | <p>Activates/deactivates the connection to the SNTP server.</p> <p>Possible values:</p> <ul style="list-style-type: none">▶ marked The connection to the SNTP server is activated. The SNTP client has access to the SNTP server.▶ unmarked (default setting) The connection to the SNTP server is deactivated. The SNTP client has no access to the SNTP server. |

■ Buttons

You find the description of the standard buttons in section [“Buttons” on page 18](#).

2.2.2 SNTP Server

In this dialog, you specify the settings with which the device operates as an SNTP server.

The SNTP server provides the Universal Time Coordinated (UTC) without considering local time differences.

If the setting is appropriate, the SNTP server operates in the broadcast mode: In broadcast mode, the SNTP server automatically sends broadcast messages or multicast messages according to the broadcast send interval.

■ Operation

| Parameters | Meaning |
|------------|--|
| Operation | <p>Enables/disables the <i>SNTP Server</i> function of the device.</p> <p>Possible values:</p> <ul style="list-style-type: none"> ▶ On The <i>SNTP Server</i> function is enabled. The device operates as an SNTP server. ▶ Off (default setting) The <i>SNTP Server</i> function is disabled. <p>Note the setting in the <i>Disable server at local time source</i> checkbox in the <i>Configuration</i> frame.</p> |

■ Configuration

| Parameters | Meaning |
|-------------------------------|---|
| UDP port | <p>Specifies the number of the UDP port on which the SNTP server of the device receives requests from other clients.</p> <p>Possible values:</p> <ul style="list-style-type: none"> ▶ 1..65535 (default setting: 123) Exception: Port 2222 is reserved for internal functions. |
| Broadcast admin mode | <p>Activates/deactivates the Broadcast mode:</p> <ul style="list-style-type: none"> ▶ marked The SNTP server replies to requests from SNTP clients in Unicast mode and also sends SNTP packets in Broadcast mode as Broadcasts or Multicasts. ▶ unmarked (default setting) The SNTP server replies to requests from SNTP clients in the Unicast mode. |
| Broadcast destination address | <p>Specifies the IP address to which the SNTP server of the device sends the SNTP packets in Broadcast mode.</p> <p>Possible values:</p> <ul style="list-style-type: none"> ▶ Valid IPv4 address (default setting: 0.0.0.0) <p>Broadcast and Multicast addresses are permitted.</p> |
| Broadcast UDP port | <p>Specifies the number of the UDP port on which the SNTP server sends the SNTP packets in Broadcast mode.</p> <p>Possible values:</p> <ul style="list-style-type: none"> ▶ 1..65535 (default setting: 123) Exception: Port 2222 is reserved for internal functions. |

| Parameters | Meaning |
|-------------------------------------|---|
| Broadcast VLAN ID | <p>Specifies the ID of the VLAN in which the SNTP server of the device sends the SNTP packets in Broadcast mode.</p> <p>Possible values:</p> <ul style="list-style-type: none">▶ 0 The SNTP server sends the SNTP packets in the same VLAN in which the management access to the device is possible. See the <i>Basic Settings > Network</i> dialog.▶ 1..4042 (default setting: 1) |
| Broadcast send interval [s] | <p>Specifies the time interval at which the SNTP server of the device sends SNTP broadcast packets.</p> <p>Possible values:</p> <ul style="list-style-type: none">▶ 64..1024 (default setting: 128) |
| Disable server at local time source | <p>Activates/deactivates the disabling of the SNTP Broadcast server when the device is synchronized to the local clock.</p> <p>Possible values:</p> <ul style="list-style-type: none">▶ marked The disabling of the SNTP Broadcast server is active. The device disables the SNTP Broadcast server when the device is synchronized to the local clock. The SNTP server continues to reply to requests from SNTP clients. In the SNTP packet, the SNTP server informs the clients that it is synchronized locally.▶ unmarked (default setting) The disabling of the SNTP Broadcast server is inactive. The SNTP Broadcast server remains active when the device is synchronized to the local clock. |

■ State

| Parameters | Meaning |
|------------|--|
| State | <p>Displays the state of the SNTP server.</p> <p>Possible values:</p> <ul style="list-style-type: none">▶ disabled The SNTP server is disabled.▶ notSynchronized The SNTP server is not synchronized with either a local or an external reference clock.▶ syncToLocal The SNTP server is synchronized with the hardware clock of the device.▶ syncToRefclock The SNTP server is synchronized with an external reference clock, for example PTP.▶ syncToRemoteServer The SNTP server is synchronized with an SNTP server that is higher than the device in a cascade. |

■ Buttons

You find the description of the standard buttons in section [“Buttons” on page 18](#).

2.3 PTP

The menu contains the following dialogs:

- ▶ PTP Global
- ▶ PTP Boundary Clock
- ▶ PTP Transparent Clock

2.3.1 PTP Global

The Precision Time Protocol (PTP) is a procedure described in the IEEE 1588-2008 standard that supplies the devices in the network with a precise time. The procedure enables the clocks in the network to be synchronized to a degree of precision of just a few 100 ns. The protocol uses Multicast communication, so the load on the network due to the PTP synchronization messages is negligible.

PTP is significantly more accurate than SNTP. If SNTP and PTP are enabled in the device at the same time, then PTP has priority.

Using the “Best Master Clock” algorithm, the devices determine the devices in the network with the most accurate time which are to be used as a reference time source (Grandmaster). Subsequently the participating devices synchronize themselves with this reference time source.

If you want to transport PTP time accurately through your network, use devices with PTP hardware support exclusively on the transport paths.

The protocol differentiates between the following clocks:

- ▶ Boundary Clock (BC)
This clock has any number of PTP ports and operates as both PTP master and PTP slave. In its respective network segment, the clock operates as an Ordinary Clock.
 - As PTP slave, the clock synchronizes itself with a PTP master that is higher than the device in the cascade.
 - As PTP master, the clock forwards the time information via the network to PTP slaves that are higher than the device in the cascade.
- ▶ Transparent Clock (TC)
This clock has any number of PTP ports. In contrast to the Boundary Clock, this clock corrects the time information before forwarding it, without synchronizing itself.

In this dialog, you specify basic settings for PTP.

■ Operation IEEE1588/PTP

| Parameters | Meaning |
|------------------------|--|
| Operation IEEE1588/PTP | Enables/disables the <i>PTP</i> function. Possible values: <ul style="list-style-type: none">▶ On The <i>PTP</i> function is enabled. The device synchronizes its clock with PTP. If SNTP is enabled in the device at the same time, PTP has priority.▶ Off (default setting) The <i>PTP</i> function is disabled. The device transmits the PTP synchronization messages without any correction at every port. |

■ Configuration IEEE1588/PTP

| Parameters | Meaning |
|------------|---|
| PTP mode | Specifies the PTP version and mode of the local clock. Possible values: <ul style="list-style-type: none">▶ v2-transparent-clock (default setting)▶ v2-boundary-clock |

| Parameters | Meaning |
|-----------------------|--|
| Sync lower bound [ns] | <p>Specifies the lower threshold value in nanoseconds for the path difference between the local clock and the reference time source (Grandmaster). If the path difference falls below this value one time, then the local clock is classed as synchronized.</p> <p>Possible values: ▶ 0..999999999 (default setting: 30)</p> |
| Sync upper bound [ns] | <p>Specifies the upper threshold in nanoseconds for the path difference between the local clock and the reference time source (Grandmaster). If the path difference exceeds this value one time, then the local clock is classed as unsynchronized.</p> <p>Possible values: ▶ 31..1000000000 (default setting: 5000)</p> |
| PTP management | <p>Activates/deactivates the PTP management defined in the PTP standard.</p> <p>Possible values: ▶ marked PTP management is activated. ▶ unmarked (default setting) PTP management is deactivated.</p> |

■ Status

| Parameters | Meaning |
|---------------------------|---|
| Is synchronized | <p>Displays whether the local clock is synchronized with the reference clock (Grandmaster). The local clock is synchronized when the path difference between the local clock and the reference clock (Grandmaster) falls below the synchronization lower threshold one time. This status is kept until the path difference exceeds the synchronization upper threshold one time. You specify the synchronization thresholds in the <i>Configuration IEEE1588/PTP</i> frame.</p> |
| Max. offset absolute [ns] | <p>Displays the maximum path difference in nanoseconds that has occurred since the local clock was synchronized with the reference clock (Grandmaster).</p> |
| PTP time | <p>Displays the date and time for the PTP time scale when the local clock is synchronized with the reference clock (Grandmaster). Format: Month Day, Year hh:mm:ss AM/PM</p> |

■ Buttons

You find the description of the standard buttons in section [“Buttons” on page 18](#).

2.3.2 PTP Boundary Clock

With this menu you can configure the Boundary Clock mode for the local clock.

The menu contains the following dialogs:

- ▶ [PTP Boundary Clock Global](#)
- ▶ [PTP Boundary Clock Port](#)

2.3.2.1 PTP Boundary Clock Global

In this dialog, you enter general, cross-port settings for the Boundary Clock mode for the local clock. The Boundary Clock (BC) operates according to PTP version 2 (IEEE 1588-2008).

The settings are effective when the local clock operates as the Boundary Clock (BC). For this, you select in the *Time > PTP > Global* dialog in the *PTP mode* field the value `v2-boundary-clock`.

■ Operation IEEE1588/PTPv2 BC

| Parameters | Meaning |
|---------------|---|
| Priority 1 | <p>Specifies priority 1 for the port.</p> <p>Possible values: ▶ 0..255 (default setting: 128)</p> <p>The “Best Master Clock” algorithm first evaluates priority 1 of the participating devices in order to determine the reference time source (Grandmaster). The lower you set this value, the more probable it is that the device becomes the reference time source (Grandmaster). See the <i>Grandmaster</i> frame.</p> |
| Priority 2 | <p>Specifies priority 2 for the port.</p> <p>Possible values: ▶ 0..255 (default setting: 128)</p> <p>The “Best Master Clock” algorithm evaluates priority 2 of the participating devices if the previously evaluated criteria are the same for multiple devices. The lower you set this value, the more probable it is that the device becomes the reference time source (Grandmaster). See the <i>Grandmaster</i> frame.</p> |
| Domain number | <p>Assigns the device to a PTP domain.</p> <p>Possible values: ▶ 0..255 (default setting: 0)</p> <p>The device transmits time information from and to devices in the same domain exclusively.</p> |

■ Status IEEE1588/PTPv2 BC

| Parameters | Meaning |
|-----------------------|---|
| Two step | Displays that the clock is operating in Two-Step mode. |
| Steps removed | <p>Displays the number of communication paths passed through between the local clock of the device and the reference clock (Grandmaster). For a PTP slave, the value 1 means that the clock is connected with the reference time source (Grandmaster) directly via 1 communication path.</p> |
| Offset to master [ns] | <p>Displays the measured difference (offset) between the local clock and the reference clock (Grandmaster) in nanoseconds. The PTP slave calculates the difference from the time information received.</p> <p>In Two-Step mode the time information consists of 2 PTP synchronization messages each, which the PTP master sends cyclically:</p> <ul style="list-style-type: none"> ▶ The first synchronization message (sync message) contains an estimated value for the exact sending time of the message. ▶ The second synchronization message (follow-up message) contains the exact sending time of the first message. <p>The PTP slave uses the two PTP synchronization messages to calculate the difference (offset) from the master and corrects its clock by this difference. Here the PTP slave also considers the <i>Delay to master [ns]</i>.</p> |

| Parameters | Meaning |
|----------------------|---|
| Delay to master [ns] | Displays the delay when transmitting the PTP synchronization messages from the PTP master to the PTP slave in nanoseconds. The PTP slave sends a "Delay Request" packet to the PTP master and thus determines the exact sending time of the packet. When it receives the packet, the PTP master generates a time stamp and sends this in a "Delay Response" packet back to the PTP slave. The PTP slave uses the two packets to calculate the delay, and considers this starting from the next offset measurement. The prerequisite is that the delay mechanism value of the slave ports is specified as <i>e2e</i> . |

■ Grandmaster

This frame displays the criteria that the "Best Master Clock" algorithm evaluates when determining the reference clock (Grandmaster).

The algorithm first evaluates priority 1 of the participating devices. The device with the smallest value for priority 1 becomes the reference time source (Grandmaster). If the value is the same for multiple devices, the algorithm takes the next criterion, and if this is also the same, it takes the next criterion after this one. If every value is the same for multiple devices, the smallest value in the *Clock identity* field decides which device becomes the reference time source (Grandmaster).

The device allows you to influence which device in the network becomes the reference clock (Grandmaster). To do this, you go to the *Operation IEEE1588/PTPv2 BC* frame and modify the value in the *Priority 1* field or the *Priority 2* field.

| Parameters | Meaning |
|----------------|--|
| Priority 1 | Displays priority 1 for the device that is currently the reference time source (Grandmaster). |
| Clock class | Class of the reference clock (Grandmaster). Parameter for the Best Master Clock algorithm. |
| Clock accuracy | Estimated accuracy of the reference clock (Grandmaster). Parameter for the Best Master Clock algorithm. |
| Clock variance | Variance of the reference clock, also known as the "offset scaled log variance". Parameter for the Best Master Clock algorithm. |
| Priority 2 | Displays priority 2 for the device that is currently the reference time source (Grandmaster). |

■ Local time properties

| Parameters | Meaning |
|----------------|---|
| Time source | Specifies the time source from which the local clock gets its time information. Possible values: ▶ atomicClock ▶ gps ▶ terrestrialRadio ▶ ptp ▶ ntp ▶ handSet ▶ other ▶ internalOscillator (default setting) |
| UTC offset [s] | Specifies the difference between the PTP time scale and the UTC. See the <i>PTP timescale</i> checkbox. Possible values: ▶ -32768..32767 Note: The default setting is the value valid on the creation date of the device software. You can find further information in the "Bulletin C" of the Earth Rotation and Reference Systems Service (IERS): http://www.iers.org/IERS/EN/Publications/Bulletins/bulletins.html |

| Parameters | Meaning |
|---------------------|--|
| UTC offset valid | Specifies whether the value specified in the <i>UTC offset [s]</i> field is correct. Possible values: ▶ marked ▶ unmarked (default setting) |
| Time traceable | Displays whether the device gets the time from a primary UTC reference, for example from an NTP server. Possible values: ▶ marked ▶ unmarked |
| Frequency traceable | Displays whether the device gets the frequency from a primary UTC reference, for example from an NTP server. Possible values: ▶ marked ▶ unmarked |
| PTP timescale | Displays whether the device uses the PTP time scale. Possible values: ▶ marked ▶ unmarked According to IEEE 1588, the PTP time scale is the TAI atomic time started on 01.01.1970. In contrast to UTC, TAI does not use leap seconds. On 01.01.2011, the difference between TAI and UTC was +34 seconds. |

■ Identities

| Parameters | Meaning |
|----------------------|--|
| Clock identity | Displays the device's own identification number (UUID). |
| Parent port identity | Displays the port identification number (UUID) of the directly superior master device. |
| Grandmaster identity | Displays the identification number (UUID) of the reference clock device. |

The device displays the identities as byte sequences in hexadecimal notation.

The identification numbers (UUID) are made up as follows:

- ▶ The device identification number consists of the MAC address of the device, with the values ff and fe added between byte 3 and byte 4.
- ▶ The port UUID consists of the device identification number followed by a 16-bit port ID.

■ Buttons

You find the description of the standard buttons in section [“Buttons” on page 18](#).

2.3.2.2 PTP Boundary Clock Port

In this dialog, you specify the Boundary Clock (BC) settings on each individual port.

The settings are effective when the local clock operates as the Boundary Clock (BC). For this, you select in the *Time > PTP > Global* dialog in the *PTP mode* field the value `v2-boundary-clock`.

■ Table

| Parameters | Meaning |
|---------------|--|
| Port | Displays the port number. |
| PTP enable | Activates/deactivates PTP synchronization message transmission on the port. Possible values: <ul style="list-style-type: none">▶ <code>marked</code> (default setting) The transmission is activated. The port sends and receives PTP synchronization messages.▶ <code>unmarked</code> The transmission is deactivated. The port blocks PTP synchronization messages. |
| PTP status | Displays the current status of the port. Possible values: <ul style="list-style-type: none">▶ <code>initializing</code> Initialization phase▶ <code>faulty</code> Faulty mode: error in the PTP protocol.▶ <code>disabled</code> PTP is disabled on the port.▶ <code>listening</code> Device port is waiting for PTP synchronization messages.▶ <code>pre-master</code> PTP pre-master mode▶ <code>master</code> PTP master mode▶ <code>passive</code> PTP passive mode▶ <code>uncalibrated</code> PTP uncalibrated mode▶ <code>slave</code> PTP slave mode |
| Sync interval | Specifies the interval in seconds at which the port transmits PTP synchronization messages. Possible values: <ul style="list-style-type: none">▶ 0.25▶ 0.5▶ 1 (default setting)▶ 2 |

| Parameters | Meaning |
|------------------------|---|
| Delay mechanism | <p>Specifies the mechanism with which the device measures the delay for transmitting the PTP synchronization messages.</p> <p>Possible values:</p> <ul style="list-style-type: none"> ▶ disabled The measurement of the delay for the PTP synchronization messages for the connected PTP devices is inactive. ▶ e2e (default setting) End-to-end: As the PTP slave, the port measures the delay for the PTP synchronization messages to the PTP master. The device displays the measured value in the <i>Time > PTP > Boundary Clock > Global</i> dialog. ▶ p2p Peer-to-peer: The device measures the delay for the PTP synchronization messages for the connected PTP devices, provided that these devices support P2P. This mechanism saves the device from having to determine the delay again in the case of a reconfiguration. If you specify this value, the value IEEE 802.3 is exclusively available in the <i>Network protocol</i> column. |
| P2P delay | <p>Displays the measured Peer-to-Peer delay for the PTP synchronization messages. The prerequisite is that you select the value p2p in the <i>Delay mechanism</i> column.</p> |
| P2P delay interval [s] | <p>Specifies the interval in seconds at which the port measures the Peer-to-Peer delay. The prerequisite is that you have specified the value p2p on this port and on the port of the remote terminal.</p> <p>Possible values:</p> <ul style="list-style-type: none"> ▶ 1 (default setting) ▶ 2 ▶ 4 ▶ 8 ▶ 16 ▶ 32 |
| Network protocol | <p>Specifies which protocol the port uses to transmit the PTP synchronization messages.</p> <p>If you change the value for a port, the device changes after clicking the <input checked="" type="checkbox"/> button every port to this value.</p> <p>Possible values:</p> <ul style="list-style-type: none"> ▶ IEEE 802.3 (default setting) ▶ UDP/IPv4 This value is available solely if in the <i>Delay mechanism</i> column another value than P2P is specified. |
| Announce interval [s] | <p>Specifies the interval in seconds at which the port transmits messages for the PTP topology discovery. Assign the same value to every device of a PTP domain.</p> <p>Possible values:</p> <ul style="list-style-type: none"> ▶ 1 ▶ 2 (default setting) ▶ 4 ▶ 8 ▶ 16 |
| Announce timeout | <p>Specifies the number of announce intervals.</p> <p>Example: For the default setting (<i>Announce interval [s]</i> = 2 and <i>Announce timeout</i> = 3), the timeout is 3 x 2 s = 6 s.</p> <p>Possible values:</p> <ul style="list-style-type: none"> ▶ 2..10 (default setting: 3) Assign the same value to every device of a PTP domain. |
| E2E delay interval [s] | <p>Displays the interval in seconds at which the port measures the End-to-End delay:</p> <ul style="list-style-type: none"> ▶ If the port is operating as the PTP master, the device assigns the port the value 8. ▶ If the port is operating as the PTP slave, the value is specified by the PTP master connected to the port. |

| Parameters | Meaning |
|---------------------------|--|
| V1 hardware compatibility | <p>Specifies whether the port adjusts the length of the PTP synchronization messages when you have set in the <i>Network protocol</i> column the value <code>udpIpv4</code>. It is possible that other devices in the network expect the PTP synchronization messages to be the same length as PTPv1 messages.</p> <p>Possible values:</p> <ul style="list-style-type: none"> ▶ <code>auto</code> (default setting) The device automatically detects whether other devices in the network expect the PTP synchronization messages to be the same length as PTPv1 messages. If this is the case, the device extends the length of the PTP synchronization messages before transmitting them. ▶ <code>on</code> The device extends the length of the PTP synchronization messages before transmitting them. ▶ <code>off</code> The device transmits PTP synchronization messages without changing the length. |
| Asymmetry | <p>Corrects the measured delay value corrupted by asymmetrical transmission paths.</p> <p>Possible values:</p> <ul style="list-style-type: none"> ▶ <code>-2000000000..2000000000</code> (default setting: 0) <p>The value represents the delay symmetry in nanoseconds. A measured delay value of x ns corresponds to an asymmetry of $x \cdot 2$ ns. The value is positive if the delay from the PTP master to the PTP slave is longer than in the opposite direction.</p> |
| VLAN | <p>Specifies the VLAN ID with which the device marks the PTP synchronization messages on this port.</p> <p>Possible values:</p> <ul style="list-style-type: none"> ▶ <code>none</code> (default setting) The device transmits PTP synchronization messages without a VLAN tag. ▶ <code>0..4042</code> You specify VLANs that you have already set up in the device from the list. <p>Verify that that the port is a member of the VLAN. See the <i>Switching > VLAN > Configuration</i> dialog.</p> |
| VLAN priority | <p>Specifies the priority with which the device transmits the PTP synchronization messages marked with a VLAN ID (Layer 2, IEEE 802.1D).</p> <p>Possible values:</p> <ul style="list-style-type: none"> ▶ <code>0..7</code> (default setting: 4) <p>If you have specified in the <i>VLAN</i> column the value <code>none</code>, the device ignores the VLAN priority.</p> |

■ Buttons

You find the description of the standard buttons in section [“Buttons” on page 18](#).

2.3.3 PTP Transparent Clock

With this menu you can configure the Transparent Clock mode for the local clock.

The menu contains the following dialogs:

- ▶ [PTP Transparent Clock Global](#)
- ▶ [PTP Transparent Clock Port](#)

2.3.3.1 PTP Transparent Clock Global

In this dialog, you enter general, cross-port settings for the Transparent Clock mode for the local clock. The Transparent Clock (BC) operates according to PTP version 2 (IEEE 1588-2008).

The settings are effective when the local clock operates as the Transparent Clock (TC). For this, you select in the *Time > PTP > Global* dialog in the *PTP mode* field the value `v2-transparent-clock`.

■ Operation IEEE1588/PTPv2 TC

| Parameters | Meaning |
|-------------------|--|
| Delay mechanism | <p>Specifies the mechanism with which the device measures the delay for transmitting the PTP synchronization messages.</p> <p>Possible values:</p> <ul style="list-style-type: none">▶ <code>e2e</code> (default setting) As the PTP slave, the port measures the delay for the PTP synchronization messages to the PTP master. The device displays the measured value in the <i>Time > PTP > Transparent Clock > Global</i> dialog.▶ <code>p2p</code> The device measures the delay for the PTP synchronization messages for every connected PTP device, provided that the device supports P2P. This mechanism saves the device from having to determine the delay again in the case of a reconfiguration. If you specify this value, the value <code>IEEE 802.3</code> is exclusively available in the <i>Network protocol</i> field.▶ <code>e2e-optimized</code> Like <code>e2e</code>, with the following special characteristics:<ul style="list-style-type: none">– The device transmits the delay requests of the PTP slaves solely to the PTP master, even though these requests are multicast messages. The device thus spares the other devices from unnecessary multicast requests.– If the master-slave topology changes, the device relearns the port for the PTP master as soon as it receives a synchronization message from another PTP master.– If the device does not know a PTP master, it transmits delay requests to the ports.▶ <code>disabled</code> The delay measuring is disabled on the port. The device discards messages for the delay measuring. |
| Primary domain | <p>Assigns the device to a PTP domain.</p> <p>Possible values:</p> <ul style="list-style-type: none">▶ <code>0..255</code> (default setting: 0) <p>The device transmits time information from and to devices in the same domain exclusively.</p> |
| Network protocol | <p>Specifies which protocol the port uses to transmit the PTP synchronization messages.</p> <p>Possible values:</p> <ul style="list-style-type: none">▶ <code>ieee8023</code> (default setting)▶ <code>udpIpv4</code> Available solely if in the <i>Delay mechanism</i> option list another radio button than <code>p2p</code> is selected. |
| Multi domain mode | <p>Activates/deactivates the PTP synchronization message correction in every PTP domain.</p> <p>Possible values:</p> <ul style="list-style-type: none">▶ <code>marked</code> The device corrects PTP synchronization messages in every PTP domain.▶ <code>unmarked</code> (default setting) The device corrects PTP synchronization messages in the primary PTP domain exclusively. See the <i>Primary domain</i> field. |

| Parameters | Meaning |
|---------------|---|
| VLAN ID | <p>Specifies the VLAN ID with which the device marks the PTP synchronization messages on this port.</p> <p>Possible values:</p> <ul style="list-style-type: none"> ▶ <code>none</code> (default setting) The device transmits PTP synchronization messages without a VLAN tag. ▶ <code>0..4042</code> You specify VLANs that you have already set up in the device from the list. |
| VLAN priority | <p>Specifies the priority with which the device transmits the PTP synchronization messages marked with a VLAN ID (Layer 2, IEEE 802.1D).</p> <p>Possible values:</p> <ul style="list-style-type: none"> ▶ <code>0..7</code> (default setting: 4) <p>If you have specified the value <code>none</code> in the VLAN ID field the device ignores the specified value.</p> |

■ Local synchronization

| Parameters | Meaning |
|-------------------------|---|
| Syntonize | <p>Activates/deactivates the frequency synchronization of the Transparent Clock with the PTP master.</p> <p>Possible values:</p> <ul style="list-style-type: none"> ▶ <code>marked</code> (default setting) The frequency synchronization is active. The device synchronizes the frequency. ▶ <code>unmarked</code> The frequency synchronization is inactive. The frequency remains constant. |
| Synchronize local clock | <p>Activates/deactivates the synchronization of the local system time.</p> <p>Possible values:</p> <ul style="list-style-type: none"> ▶ <code>marked</code> The synchronization is active. The device synchronizes the local system time with the time received via PTP. The prerequisite is that the <i>Syntonize</i> checkbox is marked. ▶ <code>unmarked</code> (default setting) The synchronization is inactive. The local system time remains constant. |
| Current master | <p>Displays the port identification number (UUID) of the master device on which the device synchronizes its frequency.</p> <p>If the value contains zeros exclusively, this is because:</p> <ul style="list-style-type: none"> ▶ The <i>Syntonize</i> function is disabled. or ▶ The device cannot find a PTP master. |
| Offset to master [ns] | <p>Displays the measured difference (offset) between the local clock and the PTP master in nanoseconds. The device calculates the difference from the time information received. The prerequisite is that the <i>Synchronize local clock</i> function is enabled.</p> |
| Delay to master [ns] | <p>Displays the delay when transmitting the PTP synchronization messages from the PTP master to the PTP slave in nanoseconds.</p> <p>Prerequisite:</p> <ul style="list-style-type: none"> ▶ The <i>Synchronize local clock</i> function is enabled. ▶ In the <i>Delay mechanism</i> field, the value <code>e2e</code> is selected. |

■ Status IEEE1588/PTPv2 TC

| Parameters | Meaning |
|----------------|--|
| Clock identity | Displays the device's own identification number (UUID). The device displays the identities as byte sequences in hexadecimal notation. The device identification number consists of the MAC address of the device, with the values <code>ff</code> and <code>fe</code> added between byte 3 and byte 4. |

■ Buttons

You find the description of the standard buttons in section [“Buttons” on page 18](#).

2.3.3.2 PTP Transparent Clock Port

In this dialog, you specify the Transparent Clock (TC) settings on each individual port.

The settings are effective when the local clock operates as the Transparent Clock (TC). For this, you select in the *Time > PTP > Global* dialog in the *PTP mode* field the value `v2-transparent-clock`.

■ Table

| Parameters | Meaning |
|------------------------|---|
| Port | Displays the port number. |
| PTP enable | <p>Activates/deactivates the transmitting of PTP synchronization messages on the port.</p> <p>Possible values:</p> <ul style="list-style-type: none"> ▶ <code>marked</code> (default setting) The transmitting is active. The port sends and receives PTP synchronization messages. ▶ <code>unmarked</code> The transmitting is inactive. The port blocks PTP synchronization messages. |
| P2P delay interval [s] | <p>Specifies the interval in seconds at which the port measures the Peer-to-Peer delay. The prerequisite is that you specify the value <code>p2p</code> on this port and on the port of the remote terminal. See the <i>Delay mechanism</i> option list in the <i>Time > PTP > Transparent Clock > Global</i> dialog.</p> <p>Possible values:</p> <ul style="list-style-type: none"> ▶ 1 (default setting) ▶ 2 ▶ 4 ▶ 8 ▶ 16 ▶ 32 |
| P2P delay | <p>Displays the measured Peer-to-Peer delay for the PTP synchronization messages. The prerequisite is that you select in the <i>Delay mechanism</i> option list the radio button <code>p2p</code>. See the <i>Delay mechanism</i> field in the <i>Time > PTP > Transparent Clock > Global</i> dialog.</p> |
| Asymmetry | <p>Corrects the measured delay value corrupted by asymmetrical transmission paths.</p> <p>Possible values:</p> <ul style="list-style-type: none"> ▶ <code>-2000000000..2000000000</code> (default setting: 0) <p>The value represents the delay symmetry in nanoseconds. A measured delay value of x ns corresponds to an asymmetry of $x \cdot 2$ ns. The value is positive if the delay from the PTP master to the PTP slave is longer than in the opposite direction.</p> |

■ Buttons

You find the description of the standard buttons in section [“Buttons” on page 18](#).

Time

Time > PTP > Transparent Clock > Port

3 Device Security

The menu contains the following dialogs:

- ▶ [User Management](#)
- ▶ [Authentication List](#)
- ▶ [Management Access](#)
- ▶ [Pre-login Banner](#)

3.1 User Management

The device allows users to access its management exclusively when they log in with valid login data.

In this dialog you manage the users of the local user management. You also specify the following settings here:

- ▶ Settings for the login
- ▶ Settings for saving the passwords
- ▶ Specify policy for valid passwords

The methods that the device uses for the authentication you specify in the *Device Security > Authentication List* dialog.

■ Configuration

This frame allows you to specify settings for the login.

| Parameters | Meaning |
|----------------------|--|
| Login attempts | <p>Number of login attempts possible.</p> <p>Possible values:</p> <ul style="list-style-type: none">▶ 0..5 (default setting: 0) <p>If the user makes one more unsuccessful login attempt, the device locks access for the user. The device allows users with the <code>administrator</code> authorization to remove the lock exclusively.</p> <p>The value 0 deactivates the lock. The user has unlimited attempts to login.</p> |
| Min. password length | <p>The device accepts the password if it contains at least the number of characters specified here. The device checks the password according to this setting, regardless of the setting for the <i>Policy check</i> checkbox.</p> <p>Possible values:</p> <ul style="list-style-type: none">▶ 1..64 (default setting: 6) |

■ Password policy

This frame allows you to specify the policy for valid passwords. The device checks every new password and password change according to this policy.

The settings effect the *Password* column. The prerequisite is that you mark the checkbox in the *Policy check* column.

| Parameters | Meaning |
|------------------------------|--|
| Upper-case characters (min.) | <p>The device accepts the password if it contains at least as many upper-case letters as specified here.</p> <p>Possible values:</p> <ul style="list-style-type: none">▶ 0..16 (default setting: 1) <p>The value 0 deactivates this setting.</p> |
| Lower-case characters (min.) | <p>The device accepts the password if it contains at least as many lower-case letters as specified here.</p> <p>Possible values:</p> <ul style="list-style-type: none">▶ 0..16 (default setting: 1) <p>The value 0 deactivates this setting.</p> |

| Parameters | Meaning |
|---------------------------|--|
| Digits (min.) | <p>The device accepts the password if it contains at least as many numbers as specified here.</p> <p>Possible values:</p> <ul style="list-style-type: none"> ▶ 0..16 (default setting: 1) <p>The value 0 deactivates this setting.</p> |
| Special characters (min.) | <p>The device accepts the password if it contains at least as many special characters as specified here.</p> <p>Possible values:</p> <ul style="list-style-type: none"> ▶ 0..16 (default setting: 1) <p>The value 0 deactivates this setting.</p> |

■ Table

Every user requires an active user account to gain management access to the device. The table allows you to set up and manage user accounts.

To change settings, click the desired parameter in the table and modify the value.

| Parameters | Meaning |
|------------|---|
| User name | <p>Displays the name of the user account.</p> <p>To create a new user account, click the  button.</p> |
| Active | <p>Activates/deactivates the user account.</p> <p>Possible values:</p> <ul style="list-style-type: none"> ▶ <code>marked</code> The user account is active. The device accepts the login of a user with this user name. ▶ <code>unmarked</code> (default setting) The user account is inactive. The device rejects the login of a user with this user name. <p>When one user account exists with the <code>administrator</code> access role, this user account is always active.</p> |
| Password | <p>Displays ***** (asterisks) instead of the password with which the user logs in. To change the password, click the relevant field.</p> <p>Possible values:</p> <ul style="list-style-type: none"> ▶ Alphanumeric ASCII character string with 6..64 characters The following characters are allowed: <ul style="list-style-type: none"> - a..z - A..Z - 0..9 - # \$ % & ' () * + , - . / : ; < = > ? @ _ ` <p>The minimum length of the password is specified in the <i>Configuration</i> frame. The device differentiates between upper and lower case.</p> <p>If the checkbox in the <i>Policy check</i> column is marked, the device checks the password according to the policy specified in the <i>Password policy</i> frame.</p> <p>The device always checks the minimum length of the password, even if the checkbox in the <i>Policy check</i> column is <code>unmarked</code>.</p> |

| Parameters | Meaning |
|----------------------|--|
| Role | <p>Specifies the user role that regulates the access of the user to the individual functions of the device.</p> <p>Possible values:</p> <ul style="list-style-type: none"> ▶ <code>unauthorized</code> The user is blocked, and the device rejects the user log on. Assign this value to temporarily lock the user account. If an error occurs when another role is being assigned, the device assigns this role to the user account. ▶ <code>guest</code> (default setting) The user is authorized to monitor the device. ▶ <code>auditor</code> The user is authorized to monitor the device and to save the log file in the <i>Diagnostics > Report > Audit Trail</i> dialog. ▶ <code>operator</code> The user is authorized to monitor the device and to change the settings – with the exception of security settings for device access. ▶ <code>administrator</code> The user is authorized to monitor the device and to change the settings. <p>The device assigns the Service Type transferred in the response of a RADIUS server as follows to a user role:</p> <ul style="list-style-type: none"> - Administrative-User: administrator - Login-User: operator - NAS-Prompt-User: guest |
| User locked | <p>Unlocks the user account.</p> <p>Possible values:</p> <ul style="list-style-type: none"> ▶ <code>marked</code> The user account is locked. The user has no management access to the device. The device automatically locks a user if the user makes too many unsuccessful log in attempts. ▶ <code>unmarked</code> (grayed out) (default setting) The user account is unlocked. The user has management access to the device. |
| Policy check | <p>Activates/deactivates the password check.</p> <p>Possible values:</p> <ul style="list-style-type: none"> ▶ <code>marked</code> The password check is activated. When you set up or change the password, the device checks the password according to the policy specified in the <i>Password policy</i> frame. ▶ <code>unmarked</code> (default setting) The password check is deactivated. |
| SNMP auth type | <p>Specifies the authentication protocol that the device applies for user access via SNMPv3.</p> <p>Possible values:</p> <ul style="list-style-type: none"> ▶ <code>hmacmd5</code> (default value) For this user account, the device uses protocol HMACMD5. ▶ <code>hmacsha</code> For this user account, the device uses protocol HMACSHA. |
| SNMP encryption type | <p>Specifies the encryption protocol that the device applies for user access via SNMPv3.</p> <p>Possible values:</p> <ul style="list-style-type: none"> ▶ <code>none</code> No encryption ▶ <code>des</code> (default value) DES encryption ▶ <code>aesCfb128</code> AES128 encryption |

■ Buttons

You find the description of the standard buttons in section “Buttons” on page 18.

| Button | Meaning |
|---|--|
|  | Opens the <i>Create</i> window to add a new entry to the table. <ul style="list-style-type: none">▶ In the <i>User name</i> field, you specify the name of the user account. Possible values:<ul style="list-style-type: none">– Alphanumeric ASCII character string with 1..32 characters |

3.2 Authentication List

In this dialog you manage the authentication lists. In a authentication list you specify which method the device uses for the authentication. You also have the option to assign pre-defined applications to the authentication lists.

The device allows users to access its management exclusively when they log in with valid login data. The device authenticates the users using the following methods:

- ▶ User management of the device
- ▶ RADIUS

With the port-based access control according to IEEE 802.1X, the device allows connected end devices to access the network if they log in with valid login data. The device authenticates the end devices using the following methods:

- ▶ RADIUS
- ▶ IAS (Integrated Authentication Server)

In the default setting the following authentication lists are available:

- defaultDot1x8021AuthList
- defaultLoginAuthList
- defaultV24AuthList

■ Table





| Parameters | Meaning |
|------------|---|
| Name | Displays the name of the list. To create a new list, click the  button. Possible values: <ul style="list-style-type: none">▶ Alphanumeric ASCII character string with 1..32 characters |

| Parameters | Meaning |
|--|--|
| Policy 1 Policy 2 Policy 3 Policy 4 Policy 5 | <p>Specifies the authentication policy that the device uses for access using the application specified in the <i>Dedicated applications</i> column.</p> <p>The device gives you the option of a fall-back solution. For this, you specify another policy in each of the policy fields. Depending on the order of the values entered in each policy, if the authentication with the specified policy is unsuccessful, the device can use the next policy.</p> <p>Possible values:</p> <ul style="list-style-type: none"> ▶ <code>local</code> (default setting) The device authenticates the users by using the local user management. See the <i>Device Security > User Management</i> dialog. You cannot assign this value to the authentication list <code>defaultDot1x8021AuthList</code>. ▶ <code>radius</code> The device authenticates the users with a RADIUS server in the network. You specify the RADIUS server in the <i>Network Security > RADIUS > Authentication Server</i> dialog. ▶ <code>reject</code> The device accepts or rejects the authentication depending on which policy you try first. The following list contains authentication scenarios: <ul style="list-style-type: none"> – If the first policy in the authentication list is <code>local</code> and the device accepts the credentials of the user, then it logs the user in without attempting the other policies. – If the first policy in the authentication list is <code>local</code> and the device denies the credentials of the user, then it attempts to log the user in using the other policies in the order specified. – If the first policy in the authentication list is <code>radius</code> and the device rejects a login, then the login is immediately rejected without attempting to login the user using another policy. If there is no response from the RADIUS server, the device attempts to authentication the user with the next policy. – If the first policy in the authentication list is <code>reject</code>, then the devices immediately rejects the user login without attempting another policy. – Verify that the authentication list <code>defaultV24AuthList</code> contains at least one policy different from <code>reject</code>. ▶ <code>ias</code> The device authenticates the end devices logging in via 802.1X with the integrated authentication server (IAS). The integrated authentication server manages the log in data in a separate database. See the <i>Network Security > 802.1X Port Authentication > Integrated Authentication Server</i> dialog. You can only assign this value to the authentication list <code>defaultDot1x8021AuthList</code>. |
| Dedicated applications | <p>Displays the dedicated applications. When users access the device with the relevant application, the device uses the specified policies for the authentication.</p> <p>To allocate another application to the list or remove the allocation, click the  button and then the <i>Allocate applications</i> item. Allocate one application solely to one list.</p> |
| Active | <p>Activates/deactivates the list.</p> <p>Possible values:</p> <ul style="list-style-type: none"> ▶ <code>marked</code> The list is activated. The device uses the policies in this list when users access the device with the relevant application. ▶ <code>unmarked</code> (default setting) The list is deactivated. |

Note: If the table does not contain a list, the management access is possible using CLI through the V.24 interface of the device exclusively. In this case, the device authenticates the user by using the local user management. See the *Device Security > User Management* dialog.

■ Buttons

You find the description of the standard buttons in section “Buttons” on page 18.

| Button | Meaning |
|---|--|
|  | Displays a sub menu with the following items. |
| Allocate applications | <p>Opens the <i>Allocate applications</i> window.</p> <ul style="list-style-type: none">▶ The left field displays the applications that can be allocated to the highlighted list.▶ The right field displays the applications that are allocated to the highlighted list.▶ Buttons:<ul style="list-style-type: none">▶  Moves every entry to the right field.▶  Moves the highlighted entries from the left field to the right field.▶  Moves the highlighted entries from the right field to the left field.▶  Moves every entry to the left field. <p>Do not move the entry <code>WebInterface</code> to the left field. Otherwise the connection to the device is lost, after you click the <i>Ok</i> button.</p> |

3.3 Management Access

The menu contains the following dialogs:

- ▶ [Server](#)
- ▶ [IP Access Restriction](#)
- ▶ [Web](#)
- ▶ [Command Line Interface](#)
- ▶ [SNMPv1/v2 Community](#)

3.3.1 Server

This dialog allows you to set up the server services which enable users or applications to access the management of the device.

The dialog contains the following tabs:

- ▶ [Information]
- ▶ [SNMP]
- ▶ [Telnet]
- ▶ [SSH]
- ▶ [HTTP]
- ▶ [HTTPS]

[Information]

This tab displays as an overview which server services are enabled.

■ Table

| Parameters | Meaning |
|---------------|--|
| SNMPv1 | <p>Displays whether the server service which allows access to the device using SNMP version 1 is active or inactive. See the <i>SNMP</i> tab.</p> <p>Possible values:</p> <ul style="list-style-type: none"> ▶ marked Server service is active. ▶ unmarked Server service is inactive. |
| SNMPv2 | <p>Displays whether the server service which allows access to the device using SNMP version 2 is active or inactive. See the <i>SNMP</i> tab.</p> <p>Possible values:</p> <ul style="list-style-type: none"> ▶ marked Server service is active. ▶ unmarked Server service is inactive. |
| SNMPv3 | <p>Displays whether the server service which allows access to the device using SNMP version 3 is active or inactive. See the <i>SNMP</i> tab.</p> <p>Possible values:</p> <ul style="list-style-type: none"> ▶ marked Server service is active. ▶ unmarked Server service is inactive. |
| Telnet server | <p>Displays whether the server service which allows access to the device using Telnet is active or inactive. See the <i>Telnet</i> tab.</p> <p>Possible values:</p> <ul style="list-style-type: none"> ▶ marked Server service is active. ▶ unmarked Server service is inactive. |
| SSH server | <p>Displays whether the server service which allows access to the device using Secure Shell is active or inactive. See the <i>SSH</i> tab.</p> <p>Possible values:</p> <ul style="list-style-type: none"> ▶ marked Server service is active. ▶ unmarked Server service is inactive. |
| HTTP server | <p>Displays whether the server service which allows access to the device using the Graphical User Interface through HTTP is active or inactive. See the <i>HTTP</i> tab.</p> <p>Possible values:</p> <ul style="list-style-type: none"> ▶ marked Server service is active. ▶ unmarked Server service is inactive. |
| HTTPS server | <p>Displays whether the server service which allows access to the device using the Graphical User Interface through HTTPS is active or inactive. See the <i>HTTP</i> tab.</p> <p>Possible values:</p> <ul style="list-style-type: none"> ▶ marked Server service is active. ▶ unmarked Server service is inactive. |

■ **Buttons**



You find the description of the standard buttons in section [“Buttons” on page 18](#).

[SNMP]

This tab allows you to specify settings for the SNMP agent of the device and to enable/disable access to the device with different SNMP versions.

The SNMP agent enables management access to the device with SNMP-based applications.

■ Configuration

| Parameters | Meaning |
|-------------|--|
| SNMPv1 | <p>Activates/deactivates the access to the device with SNMP version 1.</p> <p>Possible values:</p> <ul style="list-style-type: none"> ▶ <code>marked</code> (default setting) Access is activated. ▶ <code>unmarked</code> Access is deactivated. <p>You specify the community names in the <i>Device Security > Management Access > SNMPv1/v2 Community</i> dialog.</p> |
| SNMPv2 | <p>Activates/deactivates the access to the device with SNMP version 2.</p> <p>Possible values:</p> <ul style="list-style-type: none"> ▶ <code>marked</code> (default setting) Access is activated. ▶ <code>unmarked</code> Access is deactivated. <p>You specify the community names in the <i>Device Security > Management Access > SNMPv1/v2 Community</i> dialog.</p> |
| SNMPv3 | <p>Activates/deactivates the access to the device with SNMP version 3.</p> <p>Possible values:</p> <ul style="list-style-type: none"> ▶ <code>marked</code> (default setting) Access is activated. ▶ <code>unmarked</code> Access is deactivated. <p>Network management systems like Industrial HiVision use this protocol to communicate with the device.</p> |
| UDP port | <p>Specifies the number of the UDP port on which the SNMP agent receives requests from clients.</p> <p>Possible values:</p> <ul style="list-style-type: none"> ▶ <code>1..65535</code> (default setting: 161) Exception: Port 2222 is reserved for internal functions. <p>To enable the SNMP agent to use the new port after a change, you proceed as follows:</p> <ul style="list-style-type: none"> <input type="checkbox"/> Click the  button. <input type="checkbox"/> Select in the <i>Basic Settings > Load/Save</i> dialog the active configuration profile. <input type="checkbox"/> Click the  button and then the <i>Save</i> item. <input type="checkbox"/> Restart the device. |
| SNMPover802 | <p>Activates/deactivates the access to the device through SNMP over IEEE-802.</p> <p>Possible values:</p> <ul style="list-style-type: none"> ▶ <code>marked</code> Access is activated. ▶ <code>unmarked</code> (default setting) Access is deactivated. <p>The HiDiscovery software uses SNMP over IEEE-802 to access devices without an IP address.</p> |

■ **Buttons**

You find the description of the standard buttons in section [“Buttons” on page 18](#).

[Telnet]

This tab allows you to enable/disable the Telnet server in the device and specify its settings.

The Telnet server enables management access to the device remotely through the Command Line Interface. Telnet connections are unencrypted.

■ Operation

| Parameters | Meaning |
|------------|---|
| Operation | <p>Enables/disables the Telnet server.</p> <p>Possible values:</p> <ul style="list-style-type: none"> ▶ On (default setting) The Telnet server is enabled. The management access to the device is possible through the Command Line Interface using an unencrypted Telnet connection. ▶ Off The Telnet server is disabled. <p>Note: If the SSH server is disabled and you also disable Telnet, the access to the Command Line Interface is only possible through the V.24 interface of the device.</p> |

■ Configuration

| Parameters | Meaning |
|-----------------------|---|
| TCP port | <p>Specifies the number of the TCP port on which the device receives Telnet requests from clients.</p> <p>Possible values:</p> <ul style="list-style-type: none"> ▶ 1..65535 (default setting: 23) Exception: Port 2222 is reserved for internal functions. <p>The server restarts automatically after the port is changed. Existing connections remain in place.</p> |
| Connections | Displays how many Telnet connections are currently established to the device. |
| Connections (max.) | <p>Specifies the maximum number of Telnet connections to the device that can be set up simultaneously.</p> <p>Possible values:</p> <ul style="list-style-type: none"> ▶ 1..5 (default setting: 5) |
| Session timeout [min] | <p>Specifies the timeout in minutes. After the device has been inactive for this time it ends the session for the user logged on. A change in the value takes effect the next time a user logs on to the device.</p> <p>Possible values:</p> <ul style="list-style-type: none"> ▶ 0 Deactivates the function. The connection remains established in the case of inactivity. ▶ 1..160 (default setting: 5) |

■ Buttons

You find the description of the standard buttons in section [“Buttons” on page 18](#).

[SSH]

This tab allows you to enable/disable the SSH server in the device and specify its settings required for SSH. The server works with SSH version 2.

The SSH server enables management access to the device remotely through the Command Line Interface. SSH connections are encrypted.

The SSH server identifies itself to the clients using its public RSA or DSA key. When first setting up the connection, the client program displays the user the fingerprint of this key. The fingerprint contains a hexadecimal number sequence that is easy to check. When you make this number sequence available to the users via a reliable channel, they have the option to compare both fingerprints. If the number sequences match, the client is connected to the correct server.

The device allows you to create the private and public keys (host keys) required for RSA and DSA directly on the device. Otherwise you have the option to copy your own keys to the device in PEM format. As an alternative, the device allows you to load the DSA/RSA key (host key) from an external memory upon restart. You activate this function in the *Basic Settings > External Memory* dialog, *SSH key auto upload* column.

■ Operation

| Parameters | Meaning |
|------------|---|
| Operation | <p>Enables/disables the SSH server.</p> <p>Possible values:</p> <ul style="list-style-type: none">▶ <i>On</i> (default setting) The SSH server is enabled. The management access to the device is possible through the Command Line Interface using an encrypted SSH connection. The server can solely then be started if there is an RSA or DSA signature on the device.▶ <i>Off</i> The SSH server is disabled. When you disable the SSH server, the existing connections remain established. However, the device prevents new connections from being set up. <p>Note: If the Telnet server is disabled and you also disable SSH, the access to the Command Line Interface is only possible through the V.24 interface of the device.</p> |

■ Configuration

| Parameters | Meaning |
|-----------------|---|
| TCP port | <p>Specifies the number of the TCP port on which the device receives SSH requests from clients.</p> <p>Possible values:</p> <ul style="list-style-type: none">▶ 1..65535 (default setting: 22) Exception: Port 2222 is reserved for internal functions. <p>The server restarts automatically after the port is changed. Existing connections remain in place.</p> |
| Sessions | Displays how many SSH connections are currently established to the device. |
| Sessions (max.) | <p>Specifies the maximum number of SSH connections to the device that can be set up simultaneously.</p> <p>Possible values:</p> <ul style="list-style-type: none">▶ 1..5 (default setting: 5) |

| Parameters | Meaning |
|-----------------------|---|
| Session timeout [min] | <p>Specifies the timeout in minutes. After the user logged on has been inactive for this time, the ends the connection. A change in the value takes effect the next time a user logs on to the device.</p> <p>Possible values:</p> <ul style="list-style-type: none"> ▶ 0 Deactivates the function. The connection remains established in the case of inactivity. ▶ 1..160 (default setting: 5) |

■ Fingerprint

The fingerprint is an easy-to-verify string that uniquely identifies the RSA or DSA host key of the SSH server.

| Parameters | Meaning |
|------------|---|
| DSA | Fingerprint of the public DSA host key of the server. |
| RSA | Fingerprint of the public RSA host key of the server. |

After importing a new RSA or DSA host key, the device continues to display the existing fingerprint until you restart the server.

■ Signature

| Parameters | Meaning |
|-------------|---|
| DSA present | <p>Displays whether a DSA host key is present on the device.</p> <p>Possible values:</p> <ul style="list-style-type: none"> ▶ <code>marked</code> A key is present. ▶ <code>unmarked</code> No key is present. |
| RSA present | <p>Displays whether an RSA host key is present on the device.</p> <p>Possible values:</p> <ul style="list-style-type: none"> ▶ <code>marked</code> A key is present. ▶ <code>unmarked</code> No key is present. |
| Create | <p>Generates a host key on the device. The prerequisite is that the <i>SSH</i> server is disabled.</p> <p>Length of the key created:</p> <ul style="list-style-type: none"> ▶ 2048 bit (RSA) ▶ 1024 bit (DSA) <p>To get the server to use the generated host key, you enable the server.</p> <p>Alternatively, you have the option to copy your own key to the device in PEM format. See the <i>Key import</i> frame.</p> |
| Delete | Removes the host key from the device. The prerequisite is that the SSH server is disabled. |

| Parameters | Meaning |
|-------------|---|
| Oper status | <p>Displays whether the device currently generates a host key. It is possible that another user triggered this action.</p> <p>Possible values:</p> <ul style="list-style-type: none"> ▶ dsa The device currently generates a DSA host key. ▶ rsa The device currently generates an RSA host key. ▶ both The device currently generates a DSA and a RSA host key at the same time. ▶ none The device does not generate a host key. |

■ Key import

| Parameters | Meaning |
|------------|--|
| URL | <p>Specifies the path and file name of your own DSA/RSA host key.</p> <p>The device accepts the DSA/RSA key if it has the following key length:</p> <ul style="list-style-type: none"> – 2048 bit (RSA) – 1024 bit (DSA) <p>The device gives you the following options for copying the key to the device:</p> <ul style="list-style-type: none"> ▶ Import from the PC If the host key is located on your PC or on a network drive, drag and drop the file that contains the key in the  area. Alternatively click in the area to select the file. ▶ Import from an FTP server If the key is on an FTP server, specify the URL for the file in the following form: ftp://<user>:<password>@<IP address>:<port>/<file name> ▶ Import from a TFTP server If the key is on a TFTP server, specify the URL for the file in the following form: tftp://<IP address>/<path>/<file name> ▶ Import from an SCP or SFTP server If the key is on an SCP or SFTP server, you specify the URL for the file in the following form: <ul style="list-style-type: none"> – scp:// or sftp://<IP address>/<path>/<file name> When you click the Start button, the device displays the <i>Credentials</i> window. There you enter <i>User name</i> and <i>Password</i>, to log on to the server. <ul style="list-style-type: none"> – scp:// or sftp://<user>:<password>@<IP address>/<path>/<file name> |
| Start | Copies the key specified in the <i>URL</i> field to the device. |

■ Buttons

You find the description of the standard buttons in section “Buttons” on page 18.

[HTTP]

This tab allows you to enable/disable the HTTP protocol for the web server and specify the settings required for HTTP.

The web server provides the graphical user interface via an unencrypted HTTP connection. For security reasons, disable the HTTP protocol and use the HTTPS protocol instead.

The device supports up to 10 simultaneous connections using HTTP or HTTPS.

Note: If you change the settings in this tab and click the button, the device ends the session and disconnects every opened connection. To continue working with the graphical user interface, login again.

■ Operation

| Parameters | Meaning |
|------------|---|
| Operation | <p>Enables/disables the <i>HTTP</i> protocol for the web server.</p> <p>Possible values:</p> <ul style="list-style-type: none"> ▶ On (default setting) The <i>HTTP</i> protocol is enabled. The management access to the device is possible through an unencrypted <i>HTTP</i> connection. If the <i>HTTPS</i> protocol is also enabled, the device automatically redirects the request for a <i>HTTP</i> connection to an encrypted <i>HTTPS</i> connection. ▶ Off The <i>HTTP</i> protocol is disabled. If the <i>HTTPS</i> protocol is enabled, the management access to the device is possible through an encrypted <i>HTTPS</i> connection. <p>Note: If the <i>HTTP</i> and <i>HTTPS</i> protocols are disabled, you can enable the <i>HTTP</i> protocol using the CLI command <code>http server</code> to get to the graphical user interface.</p> |

■ Configuration

| Parameters | Meaning |
|------------|---|
| TCP port | <p>Specifies the number of the TCP port on which the web server receives HTTP requests from clients.</p> <p>Possible values:</p> <ul style="list-style-type: none"> ▶ 1..65535 (default setting: 80) Exception: Port 2222 is reserved for internal functions. |

■ Buttons

You find the description of the standard buttons in section [“Buttons” on page 18](#).

[HTTPS]

This tab allows you to enable/disable the HTTPS protocol for the web server and specify the settings required for HTTPS.

The web server provides the graphical user interface via an encrypted HTTP connection. A digital certificate is required for the encryption of the HTTP connection. The device allows you to create this certificate yourself or to load an existing certificate onto the device.

The device supports up to 10 simultaneous connections using HTTP or HTTPS.

Note: If you change the settings in this tab and click the button, the device ends the session and disconnects every opened connection. To continue working with the graphical user interface, login again.

■ Operation

| Parameters | Meaning |
|------------|---|
| Operation | <p>Enables/disables the <i>HTTPS</i> protocol for the web server.</p> <p>Possible values:</p> <ul style="list-style-type: none">▶ On (default setting) The <i>HTTPS</i> protocol is enabled. The management access to the device is possible through an encrypted <i>HTTPS</i> connection. If there is no digital certificate present, the device generates a digital certificate before it enables the <i>HTTPS</i> protocol.▶ Off The <i>HTTPS</i> protocol is disabled. If the <i>HTTP</i> protocol is enabled, the management access to the device is possible through an unencrypted <i>HTTP</i> connection. <p>Note: If the <i>HTTP</i> and <i>HTTPS</i> protocols are disabled, you can enable the <i>HTTPS</i> protocol using the CLI command <code>https server</code> to get to the graphical user interface.</p> |



■ Configuration

| Parameters | Meaning |
|------------|--|
| TCP port | <p>Specifies the number of the TCP port on which the web server receives HTTPS requests from clients.</p> <p>Possible values:</p> <ul style="list-style-type: none">▶ 1..65535 (default setting: 443) Exception: Port 2222 is reserved for internal functions. |

■ Fingerprint

The fingerprint is an easily verified hexadecimal number sequence that uniquely identifies the digital certificate of the HTTPS server.

After importing a new digital certificate, the device displays the current fingerprint until you restart the server.

| Parameters | Meaning |
|------------------|---|
| Fingerprint type | <p>Specifies which fingerprint the <i>Fingerprint</i> field displays.</p> <p>Possible values:</p> <ul style="list-style-type: none"> ▶ sha1 The <i>Fingerprint</i> field displays the SHA1 fingerprint of the certificate. ▶ sha256 The <i>Fingerprint</i> field displays the SHA256 fingerprint of the certificate. |
| Fingerprint | <p>Character sequence of the digital certificate used by the server.</p> <p>When you change the settings in the <i>Fingerprint type</i> field, click afterwards the  button and then the  button to update the display.</p> |

■ Certificate

| Parameters | Meaning |
|-------------|--|
| Present | <p>Displays whether the digital certificate is present on the device.</p> <p>Possible values:</p> <ul style="list-style-type: none"> ▶ marked The certificate is present. ▶ unmarked The certificate has been removed. |
| Create | <p>Generates a digital certificate on the device. Until restarting the web server uses the previous certificate.</p> <p>To get the web server to use the newly generated certificate, restart the web server. Restarting the web server is possible solely through the Command Line Interface (CLI).</p> <p>Alternatively, you have the option of copying your own certificate to the device. See the <i>Certificate import</i> frame.</p> |
| Delete | <p>Deletes the digital certificate. Until restarting the web server uses the previous certificate.</p> |
| Oper status | <p>Displays whether the device currently generates or deletes a digital certificate. It is possible that another user has triggered the action.</p> <p>Possible values:</p> <ul style="list-style-type: none"> ▶ none The device does currently not generate or delete a certificate. ▶ delete The device currently deletes a certificate. ▶ generate The device currently generates a certificate. |

Note: When loading the graphical user interface, the web browser displays a warning if the device uses a certificate that is not signed by a certification authority. To continue, add an exception rule for the certificate in the web browser.

■ Certificate import

| Parameters | Meaning |
|------------|---|
| URL | <p>Specifies the path and file name of the certificate.</p> <p>The device accepts certificates with the following properties:</p> <ul style="list-style-type: none">– X.509 format– .PEM file name extension– Base64-coded, enclosed by<ul style="list-style-type: none">• -----BEGIN PRIVATE KEY----- and -----END PRIVATE KEY-----as well as<ul style="list-style-type: none">• -----BEGIN CERTIFICATE----- and -----END CERTIFICATE-----– RSA key with 2048 bit length <p>The device gives you the following options for copying the certificate to the device:</p> <ul style="list-style-type: none">▶ Import from the PC If the certificate is located on your PC or on a network drive, drag and drop the certificate in the  area. Alternatively click in the area to select the certificate.▶ Import from an FTP server If the certificate is on a FTP server, specify the URL for the file in the following form: ftp://<user>:<password>@<IP address>:<port>/<path>/<file name>▶ Import from a TFTP server If the certificate is on a TFTP server, specify the URL for the file in the following form: tftp://<IP address>/<path>/<file name>▶ Import from an SCP or SFTP server If the certificate is on an SCP or SFTP server, you specify the URL for the file in the following form:<ul style="list-style-type: none">– scp:// or sftp://<IP address>/<path>/<file name> When you click the <i>Start</i> button, the device displays the <i>Credentials</i> window. There you enter <i>User name</i> and <i>Password</i>, to log on to the server.– scp:// or sftp://<user>:<password>@<IP address>/<path>/<file name> |
| Start | Copies the certificate specified in the <i>URL</i> field to the device. |

■ Buttons

You find the description of the standard buttons in section “Buttons” on page 18.

3.3.2 IP Access Restriction

This dialog enables you to restrict the management access to the device to specific IP address ranges and selected IP-based applications.

- ▶ If the function is disabled, the management access to the device is possible from any IP address and using every application.
- ▶ If the function is enabled, the access is restricted. You have management access under the following conditions exclusively:
 - At least one table entry is activated.
 - and
 - You are accessing the device with a permitted application from a permitted IP address range.

■ Operation

| Parameters | Meaning |
|------------|---|
| Operation | Enables/disables the <i>IP Access Restriction</i> function. Possible values: <ul style="list-style-type: none"> ▶ On The <i>IP Access Restriction</i> function is enabled. The management access to the device is restricted. ▶ Off (default setting) The <i>IP Access Restriction</i> function is disabled. |

Note: Before you enable the function, verify that at least one active entry in the table allows you access. Otherwise, the connection to the device terminates when you change the settings. The management access to the device is possible exclusively using the CLI through the V.24 interface.

■ Table

You have the option of defining up to 16 table entries and activating them separately.

| Parameters | Meaning |
|------------|---|
| Index | Displays the index number to which the table entry relates. When you delete a table entry, this leaves a gap in the numbering. When you create a new table entry, the device fills the first gap. Possible values: <ul style="list-style-type: none"> ▶ 1..16 |
| Address | Specifies the IP address of the network from which you allow the management access to the device. You specify the network range in the <i>Netmask</i> column. Possible values: <ul style="list-style-type: none"> ▶ Valid IPv4 address (default setting: 0.0.0.0) |
| Netmask | Specifies the range of the network specified in the <i>Address</i> column. Possible values: <ul style="list-style-type: none"> ▶ Valid netmask (default setting: 0.0.0.0) |
| HTTP | Activates/deactivates the HTTP access. Possible values: <ul style="list-style-type: none"> ▶ marked (default setting) Access is activated for the adjacent IP address range. ▶ unmarked Access is deactivated. |

| Parameters | Meaning |
|--------------|--|
| HTTPS | <p>Activates/deactivates the HTTPS access.</p> <p>Possible values:</p> <ul style="list-style-type: none"> ▶ <code>marked</code> (default setting) Access is activated for the adjacent IP address range. ▶ <code>unmarked</code> Access is deactivated. |
| SNMP | <p>Activates/deactivates the SNMP access.</p> <p>Possible values:</p> <ul style="list-style-type: none"> ▶ <code>marked</code> (default setting) Access is activated for the adjacent IP address range. ▶ <code>unmarked</code> Access is deactivated. |
| Telnet | <p>Activates/deactivates the Telnet access.</p> <p>Possible values:</p> <ul style="list-style-type: none"> ▶ <code>marked</code> (default setting) Access is activated for the adjacent IP address range. ▶ <code>unmarked</code> Access is deactivated. |
| SSH | <p>Activates/deactivates the SSH access.</p> <p>Possible values:</p> <ul style="list-style-type: none"> ▶ <code>marked</code> (default setting) Access is activated for the adjacent IP address range. ▶ <code>unmarked</code> Access is deactivated. |
| IEC61850-MMS | <p>Activates/deactivates the access to the MMS server.</p> <p>Possible values:</p> <ul style="list-style-type: none"> ▶ <code>marked</code> (default setting) Access is activated for the adjacent IP address range. ▶ <code>unmarked</code> Access is deactivated. |
| Modbus TCP | <p>Activates/deactivates the access to the <i>Modbus TCP</i> server.</p> <p>Possible values:</p> <ul style="list-style-type: none"> ▶ <code>marked</code> (default setting) Access is activated for the adjacent IP address range. ▶ <code>unmarked</code> Access is deactivated. |
| EtherNet/IP | <p>Activates/deactivates the access to the <i>EtherNet/IP</i> server.</p> <p>Possible values:</p> <ul style="list-style-type: none"> ▶ <code>marked</code> (default setting) Access is activated for the adjacent IP address range. ▶ <code>unmarked</code> Access is deactivated. |
| PROFINET | <p>Activates/deactivates the access to the <i>PROFINET</i> server.</p> <p>Possible values:</p> <ul style="list-style-type: none"> ▶ <code>marked</code> (default setting) Access is activated for the adjacent IP address range. ▶ <code>unmarked</code> Access is deactivated. |
| Active | <p>Activates/deactivates the table entry.</p> <p>Possible values:</p> <ul style="list-style-type: none"> ▶ <code>marked</code> (default setting) Table entry is activated. The device restricts the management access to the adjacent IP address range and the selected IP-based applications. ▶ <code>unmarked</code> Table entry is deactivated. |

■ **Buttons**

You find the description of the standard buttons in section [“Buttons” on page 18](#).

3.3.3 Web

In this dialog, you specify settings for the graphical user interface.

■ Configuration

| Parameters | Meaning |
|-------------------------------------|--|
| Web interface session timeout [min] | Specifies the timeout in minutes. After the device has been inactive for this time it ends the session for the user logged on. Possible values: ▶ 0..160 (default setting: 5) The value 0 deactivates the function, and the user remains logged on when inactive. |

■ Buttons

You find the description of the standard buttons in section [“Buttons” on page 18](#).

3.3.4 Command Line Interface

In this dialog, you specify settings for the Command Line Interface (CLI). You find detailed information about the Command Line Interface in the “Command Line Interface” reference manual.

The dialog contains the following tabs:

- ▶ [\[Global \]](#)
- ▶ [\[Login banner \]](#)

[Global]

This tab allows you to change the CLI prompt and to specify the automatic closing of sessions through the V.24 interface when they have been inactive.

■ Configuration

| Parameters | Meaning |
|--------------------|---|
| Login prompt | <p>Specifies the character string that the device displays in the Command Line Interface (CLI) at the start of every command line.</p> <p>Possible values:</p> <ul style="list-style-type: none">▶ Alphanumeric ASCII character string with 0..128 characters (0x20..0x7E) including space characters <p>Wildcards</p> <ul style="list-style-type: none">– %d date– %i IP address– %m MAC address– %p product name– %t time <p>Default setting: ((RED))</p> <p>Changes to this setting are immediately effective in the active CLI session.</p> |
| V.24 timeout [min] | <p>Specifies the time in minutes after which the device automatically closes the session of a logged on user in the Command Line Interface via the V.24 interface when it has been inactive.</p> <p>Possible values:</p> <ul style="list-style-type: none">▶ 0..160 (default setting: 5) <p>The value 0 deactivates the function, and the user remains logged on when inactive.</p> <p>A change in the value takes effect the next time a user logs on to the device.</p> <p>For Telnet and SSH, you specify the timeout in the <i>Device Security > Management Access > Server</i> dialog.</p> |

■ Buttons

You find the description of the standard buttons in section [“Buttons” on page 18](#).

[Login banner]

In this tab, you replace the CLI start screen with your own text.

In the default setting, the CLI start screen displays information about the device, such as the software version and the device settings. With the function in this tab, you deactivate this information and replace it with an individually specified text.

To display your own text in the CLI and in the graphical user interface before the login, you use the *Device Security > Pre-login Banner* dialog.

■ Operation

| Parameters | Meaning |
|------------|--|
| Operation | Enables/disables the <i>Login banner</i> function. Possible values: <ul style="list-style-type: none"> ▶ On The <i>Login banner</i> function is enabled. The device displays the text information specified in the <i>Banner text</i> field to the users that login to the device using the Command Line Interface (CLI). ▶ Off (default setting) The <i>Login banner</i> function is disabled. The CLI start screen displays information about the device. The text information in the <i>Banner text</i> field is kept. |

■ Banner text

| Parameters | Meaning |
|----------------------|---|
| Banner text | Specifies the character string that the device displays in the Command Line Interface at the start of every session. Possible values: <ul style="list-style-type: none"> ▶ Alphanumeric ASCII character string with 0..1024 characters (0x20..0x7E) including space characters ▶ <Tab> ▶ <Line break> |
| Remaining characters | Displays how many characters are still remaining in the <i>Banner text</i> field for the text information. Possible values: <ul style="list-style-type: none"> ▶ 1024..0 |

■ Buttons

You find the description of the standard buttons in section [“Buttons” on page 18](#).

3.3.5 SNMPv1/v2 Community

In this dialog, you specify the community name for SNMPv1/v2 applications.

Applications send requests via SNMPv1/v2 with a community name in the SNMP data packet header. Depending on the community name, the application gets read authorization or read and write authorization for the device.

You activate the access to the device via SNMPv1/v2 in the *Device Security > Management Access > Server* dialog.

■ Table

| Parameters | Meaning |
|------------|---|
| Community | Displays the authorization for SNMPv1/v2 applications to the device: <ul style="list-style-type: none">▶ Write For requests with the community name entered, the application receives read and write authorization for the device.▶ Read For requests with the community name entered, the application receives read authorization for the device. |
| Name | Specifies the community name for the adjacent authorization. Possible values: <ul style="list-style-type: none">▶ Alphanumeric ASCII character string with 0..32 characters<ul style="list-style-type: none">private (default setting for read and write authorizations)public (default setting for read authorization) |

■ Buttons

You find the description of the standard buttons in section [“Buttons” on page 18](#).

3.4 Pre-login Banner

This dialog allows you to display a greeting or information text to users before they login to the device. The users see this text in the login dialog of the graphical user interface (GUI) and of the Command Line Interface (CLI). Users logging in with SSH see the text - regardless of the client used - before or during the login.

To display the text in the Command Line Interface (CLI) exclusively, use the settings in the *Device Security > Management Access > CLI* dialog.

■ Operation

| Parameters | Meaning |
|------------|--|
| Operation | <p>Enables/disables the <i>Pre-login Banner</i> function.</p> <p>Using the <i>Pre-login Banner</i> function, the device displays a greeting or information text in the login dialog of the Graphical User Interface and of the Command Line Interface.</p> <p>Possible values:</p> <ul style="list-style-type: none"> ▶ On The <i>Pre-login Banner</i> function is enabled. The device displays the text specified in the <i>Banner text</i> field in the login dialog. ▶ Off (default setting) The <i>Pre-login Banner</i> function is disabled. The device does not display a text in the login dialog. If you entered a text in the <i>Banner text</i> field, this text is saved on the device. |

■ Banner text

| Parameters | Meaning |
|----------------------|---|
| Banner text | <p>Specifies the greeting or information text that the device displays in the Login dialog of the graphical user interface (GUI) and of the Command Line Interface (CLI).</p> <p>Possible values:</p> <ul style="list-style-type: none"> ▶ Alphanumeric ASCII character string with 0..512 characters (0x20..0x7E) including space characters ▶ <Tab> ▶ <Line break> |
| Remaining characters | <p>Displays how many characters are still remaining in the <i>Banner text</i> field.</p> <p>Possible values:</p> <ul style="list-style-type: none"> ▶ 512..0 |

■ Buttons

You find the description of the standard buttons in section [“Buttons” on page 18](#).

4 Network Security

The menu contains the following dialogs:

- ▶ Port Security
- ▶ 802.1X Port Authentication
- ▶ RADIUS
- ▶ DoS

4.1 Port Security

The device allows you to transmit only data packets from desired senders on one port. When this function is enabled, the device checks the VLAN ID and MAC address of the sender before it transmits a data packet. The device discards data packets from other senders and logs this event. If the *Auto-Disable* function is activated, the device disables the port. This restriction makes MAC Spoofing attacks more difficult. The *Auto-Disable* function enables the relevant port again automatically when the parameters are no longer being exceeded.

In this dialog a *Wizard* window helps you to connect the ports with one or more desired sources. In the device these addresses are known as *Static entries (/)*. To view the specified static addresses, highlight the relevant port and click the  button.

To keep the setup process as simple as possible, the device allows you to record the desired senders automatically. The device “learns” the senders by evaluating the received data packets. In the device these addresses are known as *Dynamic entries*. When a user-defined upper limit has been reached (*Dynamic limit*), the device stops the “learning” on the relevant port and transmits exclusively the data packets of the senders already recorded. When you adjust the upper limit to the number of expected senders, you thus make MAC Flooding attacks more difficult.

Note: With the automatic recording of the *Dynamic entries*, the device always discards the 1st data packet from unknown senders. Using this 1st data packet, the device checks whether the upper limit has been reached. The device records the sender until the upper limit is reached. Afterwards, the device transmits data packets that it receives on the relevant port from this sender.

■ Operation

| Parameters | Meaning |
|------------|---|
| Operation | Enables/disables the <i>Port Security</i> function. Possible values: <ul style="list-style-type: none">▶ On The <i>Port Security</i> function is enabled. The device checks the VLAN ID and MAC address of the source before it transmits a data packet. The device transmits solely a received data packet if its source is desired on the relevant port. Also activate the checking of the source on the relevant ports.▶ Off (default setting) The <i>Port Security</i> function is disabled. The device transmits every received data packet without checking the source. |

■ Configuration

| Parameters | Meaning |
|--------------|--|
| Auto-disable | Activates/deactivates the <i>Auto-Disable</i> function for <i>Port Security</i> . Possible values: <ul style="list-style-type: none">▶ marked The <i>Auto-Disable</i> function for <i>Port Security</i> is active. Also mark the checkbox in the <i>Auto-disable</i> column for the relevant ports.▶ unmarked (default setting) The <i>Auto-Disable</i> function for <i>Port Security</i> is inactive. |

■ **Table**

| Parameters | Meaning |
|-------------------|---|
| Port | Displays the port number. |
| Active | <p>Activates/deactivates the checking of the source on the port.</p> <p>Possible values:</p> <ul style="list-style-type: none"> ▶ <code>marked</code> The device checks every data packet received on the port and transmits it if its source is desired. Also enable the function in the <i>Operation</i> frame. ▶ <code>unmarked</code> (default setting) The device transmits every data packet received on the port without checking the source. <p>Note: If you are operating the device as an active subscriber within an MRP ring, we recommend you unmark the checkbox.</p> |
| Auto-disable | <p>Activates/deactivates the <i>Auto-Disable</i> function for the parameters that the <i>Port Security</i> function is monitoring on the port.</p> <p>Possible values:</p> <ul style="list-style-type: none"> ▶ <code>marked</code> (default setting) The <i>Auto-Disable</i> function is active on the port. The prerequisite is that you mark the checkbox <i>Auto-disable</i> in the <i>Configuration</i> frame. <ul style="list-style-type: none"> – The device disables the port if the port registers undesired source MAC addresses or more source MAC addresses than specified in the <i>Dynamic limit</i> column. The “Link status” LED for the port flashes 3× per period. – The <i>Diagnostics > Ports > Auto-Disable</i> dialog displays which ports are currently disabled due to the parameters being exceeded. – The <i>Auto-Disable</i> function reactivates the port automatically. For this you go to the <i>Diagnostics > Ports > Auto-Disable</i> dialog and specify a waiting period for the relevant port in the <i>Reset timer [s]</i> column. ▶ <code>unmarked</code> The <i>Auto-Disable</i> function on the port is inactive. |
| Send trap | <p>Activates/deactivates the sending of SNMP traps when the device discards data packets from an undesired sender on the port.</p> <p>Possible values:</p> <ul style="list-style-type: none"> ▶ <code>marked</code> The device sends an SNMP trap when it discards data packets from an undesired sender on the port. ▶ <code>unmarked</code> (default setting) The sending of SNMP traps is deactivated. <p>The prerequisite for sending SNMP traps is that you enable the function in the <i>Diagnostics > Status Configuration > Alarms (Traps)</i> dialog and specify at least 1 trap destination.</p> |
| Trap interval [s] | <p>Specifies the delay time in seconds that the device waits after sending an SNMP trap before sending the next SNMP trap.</p> <p>Possible values:</p> <ul style="list-style-type: none"> ▶ <code>0..3600</code> (default setting: 0) <p>The value 0 deactivates the delay time.</p> |
| Dynamic limit | <p>Specifies the upper limit for the number of automatically registered sources (<i>Dynamic entries</i>). When the upper limit has been reached, the device stops “learning” on this port.</p> <p>Adjust the value to the number of expected sources.</p> <p>If the port registers more senders than specified here, the port disables the <i>Auto-Disable</i> function. The prerequisite is that you mark the checkbox in the <i>Auto-disable</i> column and the <i>Auto-disable</i> checkbox in the <i>Configuration</i> frame.</p> <p>Possible values:</p> <ul style="list-style-type: none"> ▶ <code>0</code> Deactivates the automatic registering of sources on this port. ▶ <code>1..600</code> (default setting: 600) |

| Parameters | Meaning |
|----------------------------|--|
| Static limit | Specifies the upper limit for the number of sources connected to the port (<i>Static entries (/)</i>). The <i>Wizard</i> window helps you to connect the port with one or more desired sources. Possible values: ▶ 0..64 (default setting: 64) The value 0 prevents you from connecting a source with the port. |
| Dynamic entries | Displays the number of senders that the device has automatically determined. See the <i>Wizard</i> window, <i>Dynamic entries</i> field. |
| Static entries | Displays the number of senders that are linked with the port. See the <i>Wizard</i> window, <i>Static entries (/)</i> field. |
| Last violating VLAN ID/MAC | Displays the VLAN ID and MAC address of an undesired sender whose data packets the device last discarded on this port. |
| Sent traps | Displays the number of discarded data packets on this port that caused the device to send an SNMP trap. |

■ Buttons

You find the description of the standard buttons in section “Buttons” on page 18.

| Button | Meaning |
|--|---|
|  | Opens the <i>Wizard</i> dialog. In the <i>Wizard</i> dialog you assign the permitted MAC addresses to a port. |

[Wizard : Port security]

■ Select port



The *Wizard* window helps you to connect the ports with one or more desired sources.



| Parameters | Meaning |
|------------|--|
| Port | Specifies the port that you assign to the sender in the next step. |

■ Addresses

The *Wizard* window helps you to connect the ports with one or more desired sources. When you have specified the settings, click the *Finish* button.

After closing the *Wizard* window, click the button to save your settings.

| Parameters | Meaning |
|---|--|
| VLAN ID | <p>Specifies the VLAN ID of the desired source.</p> <p>Possible values: ▶ 1..4042</p> <p>To transfer the VLAN ID and the MAC address to the <i>Static entries (/)</i> field, click the <i>Add</i> button.</p> |
| MAC address | <p>Specifies the MAC address of the desired source.</p> <p>Possible values: ▶ Valid Unicast MAC address Specify the value in one of the following formats:</p> <ul style="list-style-type: none"> – without a separator, for example 001122334455 – separated by spaces, for example 00 11 22 33 44 55 – separated by colons, for example 00:11:22:33:44:55 – separated by hyphens, for example 00-11-22-33-44-55 – separated by points, for example 00.11.22.33.44.55 – separated by points after every 4th character, for example 0011.2233.4455 <p>To transfer the VLAN ID and the MAC address to the <i>Static entries (/)</i> field, click the <i>Add</i> button.</p> |
| Add | Transfers the values specified in the <i>VLAN ID</i> and <i>MAC address</i> fields to the <i>Static entries (/)</i> field. |
| Static entries (/) | <p>Displays the VLAN ID and MAC address of desired senders connected to the port.</p> <p>The device uses this field to display the number of senders connected to the port and the upper limit. You specify the upper limit for the number of entries in the table, <i>Static limit</i> field.</p> <p>Note: You cannot assign a MAC address that you assign to this port to any other port.</p> |
| Remove | Removes the entries highlighted in the <i>Static entries (/)</i> field. |
|  | Moves the entries highlighted in the <i>Dynamic entries</i> field to the <i>Static entries (/)</i> field. |
|  | <p>Moves every entry from the <i>Dynamic entries</i> field to the <i>Static entries (/)</i> field.</p> <p>If the <i>Dynamic entries</i> field contains more entries than are allowed in the <i>Static entries (/)</i> field, the device moves the foremost entries until the upper limit is reached.</p> |

| Parameters | Meaning |
|-----------------|--|
| Dynamic entries | <p>Displays in ascending order the VLAN ID and MAC address of the senders automatically recorded on this port. The device transmits data packets from these senders when it receives the data packets on this port.</p> <p>You specify the upper limit for the number of entries in the table, <i>Dynamic limit</i> field.</p> <p>The  and  buttons allow you to transfer entries from this field into the <i>Static entries (/)</i> field. In this way, you connect the relevant senders with the port.</p> |

Note: The device saves the sources connected with the port until you deactivate the checking of the source on the relevant port or in the *Operation* frame.

4.2 802.1X Port Authentication

With the port-based access control according to IEEE 802.1X, the device monitors the access to the network from connected end devices. The device (authenticator) allows an end device (supplicant) to access the network if it logs in with valid login data. The authenticator and the end devices communicate via the EAPoL (Extensible Authentication Protocol over LANs) authentication protocol.

The device supports the following methods to authenticate end devices:

- ▶ radius
A RADIUS server in the network authenticates the end devices.
- ▶ ias
The Integrated Authentication Server (IAS) implemented in the device authenticates the end devices. Compared to RADIUS, the IAS provides basic functions exclusively.

The menu contains the following dialogs:

- ▶ [802.1X Global](#)
- ▶ [802.1X Port Configuration](#)
- ▶ [802.1X Port Clients](#)
- ▶ [802.1X EAPoL Port Statistics](#)
- ▶ [802.1X Port Authentication History](#)
- ▶ [802.1X Integrated Authentication Server](#)

4.2.1 802.1X Global

This dialog allows you to specify basic settings for the port-based access control.

■ Operation

| Parameters | Meaning |
|------------|---|
| Operation | Enables/disables the <i>802.1X Port Authentication</i> function. Possible values: <ul style="list-style-type: none">▶ On The <i>802.1X Port Authentication</i> function is enabled. The device checks the access to the network from connected end devices. The port-based access control is enabled.▶ Off (default setting) The <i>802.1X Port Authentication</i> function is disabled. The port-based access control is disabled. |

■ Configuration

| Parameters | Meaning |
|-----------------------|---|
| VLAN assignment | Activates/deactivates the assigning of the relevant port to a VLAN. This function allows you to provide selected services to the connected end device in this VLAN. Possible values: <ul style="list-style-type: none">▶ marked The assigning is active. If the end device successfully authenticates itself, the device assigns to the relevant port the VLAN ID transferred by the RADIUS authentication server.▶ unmarked (default setting) The assigning is inactive. The relevant port is assigned to the VLAN specified in the <i>Network Security > 802.1X Port Authentication > Port Configuration</i> dialog, <i>Assigned VLAN ID</i> row. |
| Dynamic VLAN creation | Activates/deactivates the automatic creation of the VLAN assigned by the RADIUS authentication server if the VLAN does not exist. Possible values: <ul style="list-style-type: none">▶ marked The automatic VLAN creation is active. The device creates the VLAN if it does not exist.▶ unmarked (default setting) The automatic VLAN creation is inactive. If the assigned VLAN does not exist, the port remains assigned to the original VLAN. |
| Monitor mode | Activates/deactivates the monitor mode. Possible values: <ul style="list-style-type: none">▶ marked The monitor mode is active. The device monitors the authentication and helps with diagnosing detected errors. If an end device has not logged in successfully, the device gives the end device access to the network.▶ unmarked (default setting) The monitor mode is inactive. |

■ **Information**

| Parameters | Meaning |
|--------------------------|--|
| Monitor mode clients | Displays to how many end devices the device gave network access even though they did not login successfully. The prerequisite is that you activate the <i>Monitor mode</i> function. See the <i>Configuration</i> frame. |
| Non monitor mode clients | Displays the number of end devices to which the device gave network access after successful login. |
| Policy 1 | Displays the method that the device currently uses to authenticate the end devices using IEEE 802.1X. You specify the method used in the <i>Device Security > Authentication List</i> dialog. <input type="checkbox"/> To authenticate the end devices through a RADIUS server, you assign the <i>radius</i> policy to the <i>8021x</i> list. <input type="checkbox"/> To authenticate the end devices through the Integrated Authentication Server (IAS) you assign the <i>ias</i> policy to the <i>8021x</i> list. |

■ **Buttons**

You find the description of the standard buttons in section [“Buttons” on page 18](#).

4.2.2 802.1X Port Configuration

This dialog allows you to specify the access settings for every port.

■ Table

| Parameters | Meaning |
|------------------------------|--|
| Port | Displays the port number. |
| Port initialization | <p>Activates/deactivates the port initialization in order to activate the access control on the port or reset it to its initial state. Use this function exclusively to ports in which the <i>Port control</i> column contains the value <i>auto</i>.</p> <p>Possible values:</p> <ul style="list-style-type: none">▶ <i>marked</i> The port initialization is active. When the initialization is complete, the device changes the value to <i>unmarked</i> again.▶ <i>unmarked</i> (default setting) The port initialization is inactive. The device keeps the current port status. |
| Port reauthentication | <p>Activates/deactivates the one-time reauthentication request. Use this function exclusively to ports in which the <i>Port control</i> column contains the value <i>auto</i>. The device also allows you to periodically request the end device to login again. See the <i>Periodic reauthentication</i> column.</p> <p>Possible values:</p> <ul style="list-style-type: none">▶ <i>marked</i> The one-time reauthentication request is active. The device requests the end device to login again. Afterwards, the device changes the value to <i>unmarked</i> again.▶ <i>unmarked</i> (default setting) The one-time reauthentication request is inactive. The device keeps the end device logged in. |
| Authentication activity | <p>Displays the current status of the Authenticator (<i>Authenticator PAE state</i>).</p> <p>Possible values:</p> <ul style="list-style-type: none">▶ <i>initialize</i>▶ <i>disconnected</i>▶ <i>connecting</i>▶ <i>authenticating</i>▶ <i>authenticated</i>▶ <i>aborting</i>▶ <i>held</i>▶ <i>forceAuth</i>▶ <i>forceUnauth</i> |
| Backend authentication state | <p>Displays the current status of the connection to the authentication server (<i>Backend Authentication state</i>).</p> <p>Possible values:</p> <ul style="list-style-type: none">▶ <i>request</i>▶ <i>response</i>▶ <i>success</i>▶ <i>fail</i>▶ <i>timeout</i>▶ <i>idle</i>▶ <i>initialize</i> |

| Parameters | Meaning |
|-------------------------------|---|
| Authentication state | <p>Displays the current status of the authentication on the port (<code>Controlled Port Status</code>).</p> <p>Possible values:</p> <ul style="list-style-type: none"> ▶ <code>authorized</code> The end device is logged in successfully. ▶ <code>unauthorized</code> The end device is not logged in. |
| Port control | <p>Specifies how the device grants access to the network (<code>Port control mode</code>).</p> <p>Possible values:</p> <ul style="list-style-type: none"> ▶ <code>forceUnauthorized</code> The device blocks the access to the network. You use this setting if an end device is connected to the port that does not receive access to the network. ▶ <code>auto</code> The device grants access to the network if the end device has logged in successfully. You use this setting if an end device is connected to the port that logs in at the authenticator. If other end devices are connected through the same port, they get access to the network without additional authentication. ▶ <code>forceAuthorized</code> (default setting) The device grants access to the network. You use this setting if an end device is connected to the port that receives access to the network without logging in. |
| Quiet period [s] | <p>Specifies the time period in seconds in which the authenticator does not accept any more logins from the end device after an unsuccessful log in attempt (<code>Quiet period [s]</code>).</p> <p>Possible values:</p> <ul style="list-style-type: none"> ▶ <code>0..65535</code> (default setting: 60) |
| Transmit period [s] | <p>Specifies the period in seconds after which the authenticator requests the end device to login again. After this waiting period, the device sends an EAP request/identity data packet to the end device.</p> <p>Possible values:</p> <ul style="list-style-type: none"> ▶ <code>1..65535</code> (default setting: 30) |
| Supplicant timeout period [s] | <p>Specifies the period in seconds for which the authenticator waits for the login of the end device.</p> <p>Possible values:</p> <ul style="list-style-type: none"> ▶ <code>1..65535</code> (default setting: 30) |
| Server timeout [s] | <p>Specifies the period in seconds for which the authenticator waits for the response from the authentication server (RADIUS or IAS).</p> <p>Possible values:</p> <ul style="list-style-type: none"> ▶ <code>1..65535</code> (default setting: 30) |
| Requests (max.) | <p>Specifies how many times the authenticator requests the end device to login until the time specified in the <i>Supplicant timeout period [s]</i> column has elapsed. The device sends an EAP request/identity data packet to the end device as often as specified here.</p> <p>Possible values:</p> <ul style="list-style-type: none"> ▶ <code>0..10</code> (default setting: 2) |
| Assigned VLAN ID | <p>Displays the ID of the VLAN that the authenticator assigned to the port. This value applies exclusively to ports in which the <i>Port control</i> column contains the value <code>auto</code>.</p> <p>Possible values:</p> <ul style="list-style-type: none"> ▶ <code>0..4042</code> (default setting: 0) <p>You find the VLAN ID that the authenticator assigned to the ports in the <i>Network Security > 802.1X Port Authentication > Port Clients</i> dialog.</p> <p>To ports in which the <i>Port control</i> column contains the value <code>multiClient</code>: the device assigns the VLAN tag based on the MAC address of the end device when it receives data packets without a VLAN tag.</p> |

| Parameters | Meaning |
|-----------------------------|---|
| Assignment reason | <p>Displays the cause for the assignment of the VLAN ID. This value applies exclusively to ports in which the <i>Port control</i> column contains the value <i>auto</i>.</p> <p>Possible values:</p> <ul style="list-style-type: none"> ▶ <i>notAssigned</i> (default setting) ▶ <i>radius</i> ▶ <i>guestVlan</i> ▶ <i>unauthenticatedVlan</i> <p>You find the VLAN ID that the authenticator assigned to the ports in the <i>Network Security > 802.1X Port Authentication > Port Clients</i> dialog.</p> |
| Reauthentication period [s] | <p>Specifies the period in seconds after which the authenticator periodically requests the end device to login again.</p> <p>Possible values:</p> <ul style="list-style-type: none"> ▶ 1..65535 (default setting: 3600) |
| Periodic reauthentication | <p>Activates/deactivates periodic reauthentication requests.</p> <p>Possible values:</p> <ul style="list-style-type: none"> ▶ <i>marked</i> The periodic reauthentication requests are active. The device periodically requests the end device to login again. You specify this time period in the <i>Reauthentication period [s]</i> column. This setting becomes ineffective if the authenticator has assigned the end device the ID of a Voice, Unauthenticated or Guest VLAN. ▶ <i>unmarked</i> (default setting) The periodic reauthentication requests are inactive. The device keeps the end device logged in. |
| Guest VLAN ID | <p>Specifies the ID of the VLAN that the authenticator assigns to the port if the end device does not log in during the time period specified in the <i>Guest VLAN period</i> column. This value applies exclusively to ports in which the <i>Port control</i> column contains the value <i>auto</i>.</p> <p>This function allows you to grant end devices, without 802.1X support, access to selected services in the network.</p> <p>Possible values:</p> <ul style="list-style-type: none"> ▶ 0 (default setting) The authenticator does not assign a guest VLAN to the port. ▶ 1..4042 <p>Note: Assign to the port a VLAN set up statically in the device.</p> |
| Guest VLAN period | <p>Specifies the period in seconds for which the authenticator waits for EAPOL data packets after the end device is connected. If this period elapses, the authenticator grants the end device access to the network and assigns the port to the guest VLAN specified in the <i>Guest VLAN ID</i> column.</p> <p>Possible values:</p> <ul style="list-style-type: none"> ▶ 1..300 (default setting: 90) |
| Unauthenticated VLAN ID | <p>Specifies the ID of the VLAN that the authenticator assigns to the port if the end device does not login successfully. This value applies exclusively to ports in which the <i>Port control</i> column contains the value <i>auto</i>.</p> <p>This function allows you to grant end devices without valid login data access to selected services in the network.</p> <p>Possible values:</p> <ul style="list-style-type: none"> ▶ 0..4042 (default setting: 0) <p>The effect of the value 0 is that the authenticator does not assign a Unauthenticated VLAN to the port.</p> <p>Note: Assign to the port a VLAN set up statically in the device.</p> |

■ Buttons

You find the description of the standard buttons in section [“Buttons” on page 18](#).

4.2.3 802.1X Port Clients

This dialog displays information on the connected end devices.

■ Table

| Parameters | Meaning |
|--------------------|--|
| Port | Displays the port number. |
| User name | Displays the user name with which the end device logged in. |
| MAC address | Displays the MAC address of the end device. |
| Assigned VLAN ID | Displays the VLAN ID that the authenticator assigned to the port after the successful authentication of the end device. |
| Assignment reason | <p>Displays the reason for the assignment of the VLAN.</p> <p>Possible values:</p> <ul style="list-style-type: none"> ▶ default ▶ radius ▶ unauthenticatedVlan ▶ guestVlan ▶ monitorVlan ▶ invalid <p>The field displays solely a valid value as long as the client is authenticated.</p> |
| Session timeout | <p>Displays the remaining time in seconds until the log in of the end device expires. This value applies solely if for the port in the <i>Network Security > 802.1X Port Authentication > Port Configuration</i> dialog, <i>Port control</i> column the value <code>auto</code> is specified.</p> <p>The authentication server assigns the timeout period to the device through RADIUS. The value 0 means that the authentication server has not assigned a timeout.</p> |
| Termination action | <p>Displays the action performed by the device when the login has elapsed.</p> <p>Possible values:</p> <ul style="list-style-type: none"> ▶ default ▶ reauthenticate |

■ Buttons

You find the description of the standard buttons in section [“Buttons” on page 18](#).

4.2.4 802.1X EAPOL Port Statistics

This dialog displays which EAPoL data packets the end device has sent and received for the authentication of the end devices.

■ Table

| Parameters | Meaning |
|--------------------------------|---|
| Port | Displays the port number. |
| Received packets | Displays the total number of EAPOL data packets that the device received on the port. |
| Transmitted packets | Displays the total number of EAPOL data packets that the device sent on the port. |
| Start packets | Displays the number of EAPOL start data packets that the device received on the port. |
| Logoff packets | Displays the number of EAPOL logoff data packets that the device received on the port. |
| Response/ID packets | Displays the number of EAP response/identity data packets that the device received on the port. |
| Response packets | Displays the number of valid EAP response data packets that the device received on the port (without EAP response/identity data packets). |
| Request/ID packets | Displays the number of EAP request/identity data packets that the device received on the port. |
| Request packets | Displays the number of valid EAP request data packets that the device received on the port (without EAP request/identity data packets). |
| Invalid packets | Displays the number of EAPOL data packets with an unknown frame type that the device received on the port. |
| Received error packets | Displays the number of EAPOL data packets with an invalid packet body length field that the device received on the port. |
| Packet version | Displays the protocol version number of the EAPOL data packet that the device last received on the port. |
| Source of last received packet | Displays the sender MAC address of the EAPOL data packet that the device last received on the port. The value 00:00:00:00:00:00 means that the port has not received any EAPOL data packets yet. |

■ Buttons

You find the description of the standard buttons in section [“Buttons” on page 18](#).

4.2.5 802.1X Port Authentication History

The device registers the authentication process of the end devices that are connected to its ports. This dialog displays the information recorded during the authentication.

■ Table

| Parameters | Meaning |
|---------------------------|---|
| Port | Displays the port number. |
| Authentication time stamp | Displays the time at which the authenticator authenticated the end device. |
| Result age | Displays since when this entry has been entered in the table. |
| MAC address | Displays the MAC address of the end device. |
| VLAN ID | Displays the ID of the VLAN that was assigned to the end device before the login. |
| Authentication status | Displays the status of the authentication on the port. Possible values: ▶ success The authentication was successful. ▶ failure The authentication failed. |
| Access status | Displays whether the device grants the end device access to the network. Possible values: ▶ granted The device grants the end device access to the network. ▶ denied The device denies the end device access to the network. |
| Assigned VLAN ID | Displays the ID of the VLAN that the authenticator assigned to the port. |
| Assignment type | Displays the type of the VLAN that the authenticator assigned to the port. Possible values: ▶ default ▶ radius ▶ unauthenticatedVlan ▶ guestVlan ▶ monitorVlan ▶ notAssigned |
| Assignment reason | Displays the reason for the assignment of the VLAN ID and the VLAN type. |

■ 802.1X Port Authentication History

| Parameters | Meaning |
|------------|--|
| Port | Simplifies the table and displays solely the entries relating to the port selected here. This makes it easier for you to record the table and sort it as you desire. Possible values: ▶ all The table displays the entries for every port. ▶ <Port number> The table displays the entries that apply to the port selected here. |

■ **Buttons**

You find the description of the standard buttons in section [“Buttons” on page 18](#).

4.2.6 802.1X Integrated Authentication Server

The Integrated Authentication Server (IAS) allows you to authenticate end devices using IEEE 802.1X. Compared to RADIUS, the IAS has a very limited range of functions. The authentication is based solely on the user name and the password.

In this dialog you manage the login data of the end devices. The device allows you to set up up to 100 sets of login data.

To authenticate the end devices through the Integrated Authentication Server you assign you assign in the *Device Security > Authentication List* dialog the `ias` policy to the 8021x list.

■ Table

| Parameters | Meaning |
|------------|--|
| User name | Displays the user name of the end device. To create a new user, click the  button. |
| Password | Specifies the password with which the user authenticates. Possible values: ▶ Alphanumeric ASCII character string with 0..64 characters The device differentiates between upper and lower case. |
| Active | Activates/deactivates the login data. Possible values: ▶ <code>marked</code> The login data is active. An end device has the option of logging in through 802.1x using this login data. ▶ <code>unmarked</code> (default setting) The login data is inactive. |

■ Buttons

You find the description of the standard buttons in section [“Buttons” on page 18](#).

| Button | Meaning |
|---|--|
|  | Opens the <i>Create</i> window to add a new entry to the table. In the <i>User name</i> field, you specify the user name of the end device. |

4.3 RADIUS

With its factory settings, the device authenticates users based on the local user management. However, as the size of a network increases, it becomes more difficult to keep the login data of the users consistent across the devices.

RADIUS (Remote Authentication Dial-In User Service) allows you to authenticate and authorize the users at a central point in the network. A RADIUS server performs the following tasks here:

- ▶ **Authentication**
The authentication server authenticates the users when the RADIUS client at the access point forwards the users' login data to the server.
- ▶ **Authorization**
The authentication server authorizes logged in users for selected services by assigning various parameters for the relevant end device to the RADIUS client at the access point.
- ▶ **Accounting**
The accounting server records the traffic data that has occurred during the port authentication according to IEEE 802.1X. This enables you to subsequently determine which services the users have used, and to what extent.

The device operates in the role of the RADIUS client if you assign the `radius` policy to an application in the *Device Security > Authentication List* dialog. The device forwards the users' login data to the primary authentication server. The authentication server decides whether the login data is valid and transfers the user's authorizations to the device.

The device assigns the Service Type transferred in the response of a RADIUS server as follows to a user role existing in the device:

- Administrative-User: administrator
- Login-User: operator
- NAS-Prompt-User: guest

The device also allows you to authenticate end devices with IEEE 802.1X through an authentication server. To do this, you assign the `radius` policy to the `8021x` list in the *Device Security > Authentication List* dialog.

The menu contains the following dialogs:

- ▶ [RADIUS Global](#)
- ▶ [RADIUS Authentication Server](#)
- ▶ [RADIUS Accounting Server](#)
- ▶ [RADIUS Authentication Statistics](#)
- ▶ [RADIUS Accounting Statistics](#)

4.3.1 RADIUS Global

This dialog allows you to specify basic settings for RADIUS.

■ RADIUS configuration

| Parameters | Meaning |
|------------------------------|--|
| Retransmits (max.) | <p>Specifies how many times the device retransmits an unanswered request to the authentication server before the device sends the request to an alternative authentication server.</p> <p>Possible values: ▶ 1..15 (default setting: 4)</p> |
| Timeout [s] | <p>Specifies how many seconds the device waits for a response after a request to an authentication server before it retransmits the request.</p> <p>Possible values: ▶ 1..30 (default setting: 5)</p> |
| Accounting | <p>Activates/deactivates the accounting.</p> <p>Possible values: ▶ marked Accounting is active. The device sends the traffic data to an accounting server specified in the <i>Network Security > RADIUS > Accounting Server</i> dialog. ▶ unmarked (default setting) Accounting is inactive.</p> |
| NAS IP address (attribute 4) | <p>Specifies the IP address that the device transfers to the authentication server as attribute 4. Specify the IP address of the device or another available address.</p> <p>Possible values: ▶ Valid IPv4 address (default setting: 0.0.0.0)</p> <p>In many cases, there is a firewall between the device and the authentication server. In the Network Address Translation (NAT) in the firewall changes the original IP address, and the authentication server receives the translated IP address of the device. The device transfers the IP address in this field unchanged across the Network Address Translation (NAT).</p> |

■ Buttons

You find the description of the standard buttons in section “Buttons” on page 18.

| Button | Meaning |
|---|---|
|  | Displays a sub menu with the following items. |
| Reset | Deletes the statistics in the <i>Network Security > RADIUS > Authentication Statistics</i> dialog and in the <i>Network Security > RADIUS > Accounting Statistics</i> dialog. |

4.3.2 RADIUS Authentication Server

This dialog allows you to specify up to 8 authentication servers. An authentication server authenticates and authorizes the users when the device forwards the login data to the server.

The device sends the login data to the specified primary authentication server. If the server does not respond, the device contacts the specified authentication server that is highest in the table. If no response comes from this server either, the device contacts the next server in the table.

■ Table

| Parameters | Meaning |
|----------------------|--|
| Index | Displays the index number to which the table entry relates. |
| Name | Displays the name of the server. To change the value, click the relevant field. Possible values: ▶ Alphanumeric ASCII character string with 1..32 characters (default setting: <i>Default-RADIUS-Server</i>) |
| Address | Specifies the IP address of the server. Possible values: ▶ Valid IPv4 address |
| Destination UDP port | Specifies the number of the UDP port on which the server receives requests. Possible values: ▶ 0..65535 (default setting: 1812) Exception: Port 2222 is reserved for internal functions. |
| Secret | Displays ***** (asterisks) when you specify a password with which the device logs in to the server. To change the password, click the relevant field. Possible values: ▶ Alphanumeric ASCII character string with 1..64 characters You get the password from the administrator of the authentication server. |
| Primary server | Specifies the authentication server as primary or secondary. Possible values: ▶ <i>marked</i> The server is specified as the primary authentication server. The device sends the login data for authenticating the users to this authentication server. If you activate multiple servers, the device specifies the last server activated as the primary authentication server. ▶ <i>unmarked</i> (default setting) The server is the secondary authentication server. The device sends the login data to the secondary authentication server if it does not receive a response from the primary authentication server. |
| Active | Activates/deactivates the connection to the server. The device uses the server, if you specify in the <i>Device Security > Authentication List</i> dialog the value <i>radius</i> in one of the rows <i>Policy 1</i> to <i>Policy 5</i> . Possible values: ▶ <i>marked</i> (default setting) The connection is active. The device sends the login data for authenticating the users to this server if the preconditions named above are fulfilled. ▶ <i>unmarked</i> The connection is inactive. The device does not send any login data to this server. |

■ Buttons

You find the description of the standard buttons in section “Buttons” on page 18.

| Button | Meaning |
|---|--|
|  | <p>Opens the <i>Create</i> window to add a new entry to the table.</p> <ul style="list-style-type: none">▶ In the <i>Index</i> field, you specify the index number.▶ In the <i>Address</i> field, you specify the IP address of the server. |

4.3.3 RADIUS Accounting Server

This dialog allows you to specify up to 8 accounting servers. An accounting server records the traffic data that has occurred during the port authentication according to IEEE 802.1X. The prerequisite is that you activate in the *Network Security > RADIUS > Global* menu the *Accounting* function.

The device sends the traffic data to the first accounting server that can be reached. If it does not respond, the device contacts the next server in the table.

■ Table

| Parameters | Meaning |
|----------------------|--|
| Index | Displays the index number to which the table entry relates. Possible values: ▶ 1..8 |
| Name | Displays the name of the server. To change the value, click the relevant field. Possible values: ▶ Alphanumeric ASCII character string with 1..32 characters (default setting: Default-RADIUS-Server) |
| Address | Specifies the IP address of the server. Possible values: ▶ Valid IPv4 address |
| Destination UDP port | Specifies the number of the UDP port on which the server receives requests. Possible values: ▶ 0..65535 (default setting: 1813) Exception: Port 2222 is reserved for internal functions. |
| Secret | Displays ***** (asterisks) when you specify a password with which the device logs in to the server. To change the password, click the relevant field. Possible values: ▶ Alphanumeric ASCII character string with 1..16 characters You get the password from the administrator of the authentication server. |
| Active | Activates/deactivates the connection to the server. Possible values: ▶ <code>marked</code> (default setting) The connection is active. The device sends traffic data to this server if the preconditions named above are fulfilled. ▶ <code>unmarked</code> The connection is inactive. The device does not send any traffic data to this server. |

■ Buttons

You find the description of the standard buttons in section [“Buttons” on page 18](#).

| Button | Meaning |
|---|---|
|  | Opens the <i>Create</i> window to add a new entry to the table. ▶ In the <i>Index</i> field, you specify the index number. ▶ In the <i>Address</i> field, you specify the IP address of the server. |

4.3.4 RADIUS Authentication Statistics

This dialog displays information about the communication between the device and the authentication server. The table displays the information for each server in a separate row.

To delete the statistic, click in the *Network Security > RADIUS > Global* dialog the *Clear RADIUS statistics?* button.

■ Table

| Parameters | Meaning |
|--------------------------------------|--|
| Name | Displays the name of the server. |
| Address | Displays the IP address of the server. |
| Round trip time | Displays the time interval in hundredths of a second between the last response received from the server (Access Reply/Access Challenge) and the corresponding data packet sent (Access Request). |
| Access requests | Displays the number of access data packets that the device sent to the server. This value does not take repetitions into account. |
| Retransmitted access-request packets | Displays the number of access data packets that the device retransmitted to the server. |
| Access accepts | Displays the number of access accept data packets that the device received from the server. |
| Access rejects | Displays the number of access reject data packets that the device received from the server. |
| Access challenges | Displays the number of access challenge data packets that the device received from the server. |
| Malformed access responses | Displays the number of malformed access response data packets that the device received from the server (including data packets with an invalid length). |
| Bad authenticators | Displays the number of access response data packets with an invalid authenticator that the device received from the server. |
| Pending requests | Displays the number of access request data packets that the device sent to the server to which it has not yet received a response from the server. |
| Timeouts | Displays how many times no response to the server was received before the specified waiting time elapsed. |
| Unknown types | Displays the number data packets with an unknown data type that the device received from the server on the authentication port. |
| Packets dropped | Displays the number of data packets that the device received from the server on the authentication port and then discarded them. |

■ Buttons

You find the description of the standard buttons in section [“Buttons” on page 18](#).

4.3.5 RADIUS Accounting Statistics

This dialog displays information about the communication between the device and the accounting server. The table displays the information for each server in a separate row.

To delete the statistic, click in the *Network Security > RADIUS > Global* dialog the *Clear RADIUS statistics?* button.

■ Table

| Parameters | Meaning |
|--|--|
| Name | Displays the name of the server. |
| Address | Displays the IP address of the server. |
| Round trip time | Displays the time interval in hundredths of a second between the last response received from the server (Accounting Response) and the corresponding data packet sent (Accounting Request). |
| Accounting-request packets | Displays the number of accounting request data packets that the device sent to the server. This value does not take repetitions into account. |
| Retransmitted accounting-request packets | Displays the number of accounting request data packets that the device retransmitted to the server. |
| Received packets | Displays the number of accounting response data packets that the device received from the server. |
| Malformed packets | Displays the number of malformed accounting response data packets that the device received from the server (including data packets with an invalid length). |
| Bad authenticators | Displays the number of accounting response data packets with an invalid authenticator that the device received from the server. |
| Pending requests | Displays the number of accounting request data packets that the device sent to the server to which it has not yet received a response from the server. |
| Timeouts | Displays how many times no response to the server was received before the specified waiting time elapsed. |
| Unknown types | Displays the number data packets with an unknown data type that the device received from the server on the accounting port. |
| Packets dropped | Displays the number of data packets that the device received from the server on the accounting port and then discarded them. |

■ Buttons

You find the description of the standard buttons in section [“Buttons” on page 18](#).

4.4 DoS

Denial of Service (DoS) is a cyber-attack that aims to bring down specific services or devices. In this menu you can set up several filters to protect the device from DoS attacks.

The menu contains the following dialogs:

- ▶ [DoS Global](#)

4.4.1 DoS Global

In this dialog, you specify the DoS settings for the TCP/UDP, IP and ICMP protocols.

■ TCP/UDP

A scanner uses port scans to prepare network attacks. The scanner uses different techniques to determine running devices and open ports. This frame allows you to activate filters for specific scanning techniques.

The device supports the detection of the following scan types:

- ▶ Null scans
- ▶ Xmas scans
- ▶ SYN/FIN scans
- ▶ TCP Offset attacks
- ▶ TCP SYN attacks
- ▶ L4 Port attacks
- ▶ Minimal Header scans

| Parameters | Meaning |
|-----------------------|---|
| Null Scan filter | Activates/deactivates the Null Scan filter. The Null Scan filter detects incoming data packets with no TCP flags set and discards them. Possible values: <ul style="list-style-type: none">▶ <code>marked</code> The filter is active.▶ <code>unmarked</code> (default setting) The filter is inactive. |
| Xmas filter | Activates/deactivates the Xmas filter. The Xmas filter detects incoming data packets with the TCP flags FIN, URG and PUSH set simultaneously and discards them. Possible values: <ul style="list-style-type: none">▶ <code>marked</code> The filter is active.▶ <code>unmarked</code> (default setting) The filter is inactive. |
| SYN/FIN filter | Activates/deactivates the SYN/FIN filter. The SYN/FIN filter detects incoming data packets with the TCP flags SYN and FIN set simultaneously and discards them. Possible values: <ul style="list-style-type: none">▶ <code>marked</code> The filter is active.▶ <code>unmarked</code> (default setting) The filter is inactive. |
| TCP Offset protection | Activates/deactivates the TCP Offset protection. The TCP Offset protection detects incoming TCP data packets whose fragment offset field of the IP header is equal to 1 and discards them. The TCP Offset protection accepts UDP and ICMP packets whose fragment offset field of the IP header is equal to 1. Possible values: <ul style="list-style-type: none">▶ <code>marked</code> The protection is active.▶ <code>unmarked</code> (default setting) The protection is inactive. |

| Parameters | Meaning |
|-------------------------|--|
| TCP SYN protection | <p>Activates/deactivates the TCP SYN protection. The TCP SYN protection detects incoming data packets with the TCP flag SYN set and a L4 source port <1024 and discards them.</p> <p>Possible values:</p> <ul style="list-style-type: none"> ▶ <code>marked</code> The protection is active. ▶ <code>unmarked</code> (default setting) The protection is inactive. |
| L4 Port protection | <p>Activates/deactivates the L4 Port protection. The L4 Port protection detects incoming TCP and UDP data packets whose source port number and destination port number are identical and discards them.</p> <p>Possible values:</p> <ul style="list-style-type: none"> ▶ <code>marked</code> The protection is active. ▶ <code>unmarked</code> (default setting) The protection is inactive. |
| Min. Header Size filter | <p>Activates/deactivates the Minimal Header filter. The Minimal Header filter compares the TCP header of incoming data packets. If the data offset value multiplied by 4 is smaller than the minimum TCP header size, then the filter discards the data packet.</p> <p>Possible values:</p> <ul style="list-style-type: none"> ▶ <code>marked</code> The filter is active. ▶ <code>unmarked</code> (default setting) The filter is inactive. |
| Min. TCP header size | Displays the minimum size of a valid TCP header. |

■ IP

This frame allows you to activate or deactivate the Land Attack filter. With the land attack method, the attacking station sends data packets whose source and destination addresses are identical to those of the recipient. When you activate this filter, the device detects data packets with identical source and destination addresses and discards these.

| Parameters | Meaning |
|--------------------|--|
| Land Attack filter | <p>Activates/deactivates the Land Attack filter. The Land Attack filter detects incoming IP data packets whose source and destination IP address are identical and discards them.</p> <p>Possible values:</p> <ul style="list-style-type: none"> ▶ <code>marked</code> The filter is active. ▶ <code>unmarked</code> (default setting) The filter is inactive. |

■ ICMP

This dialog provides you with filter options for the following ICMP parameters:

- ▶ Fragmented data packets
- ▶ ICMP packets from a specific size upwards

| Parameters | Meaning |
|----------------------------|---|
| Filter fragmented packets | Activates/deactivates the filter for fragmented ICMP packets. The filter detects fragmented ICMP packets and discards them. Possible values: <ul style="list-style-type: none">▶ marked The filter is active.▶ unmarked (default setting) The filter is inactive. |
| Filter by packet size | Activates/deactivates the filter for incoming ICMP packets. The filter detects ICMP packets whose size exceeds the packet size specified in the <i>Allowed packet size [byte]</i> field and discards them. Possible values: <ul style="list-style-type: none">▶ marked The filter is active.▶ unmarked (default setting) The filter is inactive. |
| Allowed packet size [byte] | Specifies the maximum allowed payload size of ICMP packets in bytes. Mark the <i>Filter by packet size</i> checkbox if you want the device to discard incoming data packets whose size exceeds the maximum allowed size for ICMP packets. Possible values: <ul style="list-style-type: none">▶ 0..1472 (default setting: 512) |

■ Buttons

You find the description of the standard buttons in section [“Buttons” on page 18](#).

5 Switching

The menu contains the following dialogs:

- ▶ Switching Global
- ▶ Rate Limiter
- ▶ Filter for MAC Addresses
- ▶ IGMP Snooping
- ▶ MRP-IEEE
- ▶ QoS/Priority
- ▶ VLAN
- ▶ L2-Redundancy

5.1 Switching Global

This dialog allows you to specify the following settings:

- ▶ Change the Aging time of the address table
- ▶ Enable the flow control in the device
- ▶ Enable the VLAN Unaware Mode

If a large number of data packets are received in the priority queue of a port at the same time, this can cause the port memory to overflow. This happens, for example, when the device receives data on a Gigabit port and forwards it to a port with a lower bandwidth. The device discards surplus data packets.

The flow control mechanism described in standard IEEE 802.3 ensures that no data packets are lost due to a port memory overflowing. Shortly before a port memory is completely full, the device signals to the connected devices that it is not accepting any more data packets from them.

- ▶ In full-duplex mode, the device sends a pause data packet.
- ▶ In half-duplex mode, the device simulates a collision.

Then the connected devices do not send any more data packets for as long as the signaling takes. On uplink ports, this can possibly cause undesired sending breaks in the higher-level network segment (“wandering backpressure”).

According to standard IEEE 802.1Q, the device forwards data packets with a VLAN tag in a VLAN ≥ 1 . However, a small number of applications on connected end devices send or receive data packets with a VLAN ID=0. When the device receives one of these data packets, before forwarding it the device overwrites the original value in the data packet with the VLAN ID of the receiving port. When you activate the VLAN Unaware Mode, this deactivates the VLAN settings in the device. The device then transparently forwards the data packets and evaluates the priority information contained in the data packet exclusively.

■ Configuration

| Parameters | Meaning |
|----------------|--|
| MAC address | Displays the MAC address of the device. |
| Aging time [s] | Specifies the aging time in seconds. Possible values: ▶ 10..500000 (default setting: 30) The device monitors the age of the learned unicast MAC addresses. The device deletes address entries that exceed a particular age (aging time) from its address table. You find the address table in the <i>Switching > Filter for MAC Addresses</i> dialog. |
| Flow control | Activates/deactivates the flow control in the device. Possible values: ▶ marked The flow control is active in the device. Additionally activate the flow control on the required ports. See the <i>Basic Settings > Port</i> dialog, <i>Configuration</i> tab, checkbox in the <i>Flow control</i> column. ▶ unmarked (default setting) The flow control is inactive in the device. When you are using a redundancy function, you deactivate the flow control on the participating ports. If the flow control and the redundancy function are active at the same time, there is a risk that the redundancy function operates sporadically. |

| Parameters | Meaning |
|-------------------|---|
| VLAN unaware mode | <p>Activates/deactivates the VLAN unaware mode.</p> <p>Possible values:</p> <ul style="list-style-type: none">▶ <code>marked</code> The VLAN unaware mode is active. The device works in the VLAN Unaware bridging mode (802.1Q):<ul style="list-style-type: none">– The device ignores the VLAN settings in the device and the VLAN tags in the data packets. The device transmits the data packets based on their destination MAC address or destination IP address in VLAN 1.– The device ignores the VLAN settings specified in the <i>Switching > VLAN > Configuration</i> and <i>Switching > VLAN > Port</i> dialogs. Every port is assigned to VLAN 1.– The device evaluates the priority information contained in the data packet. <p>Note: You specify the VLAN ID 1 for every function on the device which uses VLAN settings. Among other things, this applies to static filters, MRP and IGMP Snooping.</p> <ul style="list-style-type: none">▶ <code>unmarked</code> (default setting) The VLAN unaware mode is inactive. The device works in the VLAN Aware bridging mode (802.1Q):<ul style="list-style-type: none">– The device evaluates the VLAN tags in the data packets.– The device transmits the data packets based on their destination MAC address or destination IP address in the corresponding VLAN.– The device evaluates the priority information contained in the data packet. |

■ Buttons

You find the description of the standard buttons in section [“Buttons” on page 18](#).

5.2 Rate Limiter

The device allows you to limit the traffic on the ports in order to help provide reliable operation even with a large traffic volume. If the traffic on a port exceeds the traffic value entered, the device discards the excess traffic on this port.

The rate limiter function operates exclusively on Layer 2, and is used to limit the effects of storms of data packets that flood the device (typically Broadcasts).

The rate limiter function ignores protocol information on higher levels, such as IP or TCP.

In this dialog, you enable the *Rate Limiter* function. The threshold value specifies the maximum amount of traffic the port receives. If the traffic on this port exceeds the threshold value, the device discards the excess traffic on this port.

| Parameters | Meaning |
|----------------------|---|
| Port | Displays the port number. |
| Threshold | <p>Specifies the threshold value for broadcast, multicast, and unicast traffic on this port:</p> <p>Possible values:</p> <ul style="list-style-type: none"> ▶ 0 (default setting) The <i>Rate Limiter</i> function is deactivated on this port. ▶ 1..24414 at 100 MBit/s 1..244140 at 1000 MBit/s <input type="checkbox"/> If the value <i>percent</i> is specified in the <i>Threshold unit</i> column, specify a percentage value between 1 and 100. <input type="checkbox"/> If the value <i>pps</i> is specified in the <i>Threshold unit</i> column, specify an absolute value. The rate limiter function calculates the threshold based on 512-byte-sized packets. <p>Note: The operating modes actually available depend on the device configuration.</p> |
| Threshold unit | <p>Specifies the unit for the threshold value:</p> <p>Possible values:</p> <ul style="list-style-type: none"> ▶ <i>percent</i> (default setting) Specifies the threshold value as a percentage of the data rate of the port. ▶ <i>pps</i> Specifies the threshold value in data packets per second. |
| Broadcast mode | <p>Activates/deactivates the rate limiter function for received broadcast data packets.</p> <p>Possible values:</p> <ul style="list-style-type: none"> ▶ <i>marked</i> ▶ <i>unmarked</i> (default setting) <p>If the threshold value is exceeded, the device discards the excess broadcast data packets on this port.</p> |
| Multicast mode | <p>Activates/deactivates the rate limiter function for received multicast data packets.</p> <p>Possible values:</p> <ul style="list-style-type: none"> ▶ <i>marked</i> ▶ <i>unmarked</i> (default setting) <p>If the threshold value is exceeded, the device discards the excess multicast data packets on this port.</p> |
| Unknown unicast mode | <p>Activates/deactivates the rate limiter function for received unicast data packets with an unknown destination address.</p> <p>Possible values:</p> <ul style="list-style-type: none"> ▶ <i>marked</i> ▶ <i>unmarked</i> (default setting) <p>If the threshold value is exceeded, the device discards the excess unicast data packets on this port.</p> |

■ **Buttons**

You find the description of the standard buttons in section [“Buttons” on page 18](#).

5.3 Filter for MAC Addresses

This dialog allows you to display and edit address filters for the address table. Address filters specify the way the data packets are forwarded in the device based on the destination MAC address.

Each row in the table represents one filter. The device automatically sets up the filters. The device allows you to set up additional filters manually.

The device transmits the data packets as follows:

- ▶ If the table contains an entry for the destination address of a data packet, the device transmits the data packet from the receiving port to the port specified in the table entry.
- ▶ If there is no table entry for the destination address, the device transmits the data packet from the receiving port to every other port.



■ Table

| Parameters | Meaning |
|---------------|--|
| Address | Displays the destination MAC address to which the table entry applies. |
| VLAN ID | Displays the ID of the VLAN to which the table entry applies. The device learns the MAC addresses for every VLAN separately (independent VLAN learning). |
| Status | Displays how the device has set up the address filter. Possible values: <ul style="list-style-type: none"> ▶ learned Address filter set up automatically by the device based on received data packets. ▶ permanent Address filter set up manually. The address filter stays set up permanently. ▶ IGMP Address filter automatically set up by IGMP Snooping. ▶ mgmt MAC address of the device. The address filter is protected against changes. ▶ invalid Deletes a manually set up address filter. ▶ MRP-MMRP Multicast address filter automatically set up by MMRP. |
| <Port number> | Displays how the corresponding port transmits data packets which it directs to the adjacent destination address. Possible values: <ul style="list-style-type: none"> ▶ - The port does not transmit any data packets to the destination address. ▶ learned The port transmits data packets to the destination address. The device created the filter automatically based on received data packets. ▶ IGMP learned The port transmits data packets to the destination address. The device created the filter automatically based on IGMP. ▶ unicast static The port transmits data packets to the destination address. A user created the filter. ▶ multicast static The port transmits data packets to the destination address. A user created the filter. |

To delete the learned MAC addresses from the address table, click in the *Basic Settings* > Restart dialog the *Reset MAC address table* button.

■ Buttons

You find the description of the standard buttons in section “Buttons” on page 18.

| Button | Meaning |
|---|---|
|  | Opens the <i>Create</i> window to add a new entry to the table. <ul style="list-style-type: none">▶ In the <i>Address</i> field, you specify the destination MAC address.▶ In the <i>VLAN ID</i> field, you specify the ID of the VLAN.▶ In the <i>Port</i> field, you specify the port.<ul style="list-style-type: none">– Select one port if the destination MAC address is a unicast address.– Select one or more ports if the destination MAC address is a multicast address.– Select no port to create a discard filter. The device discards data packets with the destination MAC address specified in the table entry. |
|  | Displays a sub menu with the following items. |
| Reset MAC address table | Removes the MAC addresses from the forwarding table that have the value <i>learned</i> in the <i>Status</i> column. |

5.4 IGMP Snooping

The Internet Group Management Protocol (IGMP) is a protocol for dynamically managing Multicast groups. The protocol describes the distribution of Multicast data packets between routers and end devices on Layer 3.

The device allows you to use the IGMP Snooping function to also use the IGMP mechanisms on Layer 2:

- ▶ Without IGMP Snooping, the device transmits the Multicast data packets to every port.
 - ▶ With the activated IGMP Snooping function, the device transmits the Multicast data packets exclusively on ports to which Multicast receivers are connected. This reduces the network load. The device evaluates the IGMP data packets transmitted on Layer 3 and uses the information on Layer 2.
- Activate the IGMP Snooping function not until the following conditions are fulfilled:
- There is a Multicast router in the network that creates IGMP queries (periodic queries).
 - The devices participating in IGMP Snooping forward the IGMP queries.

The device links the IGMP reports with the entries in its address table. If a multicast receiver joins a multicast group, the device creates a table entry for this port in the *Switching > Filter for MAC Addresses* dialog. If the multicast receiver leaves the multicast group, the device removes the table entry.

The menu contains the following dialogs:

- ▶ [IGMP Snooping Global](#)
- ▶ [IGMP Snooping Configuration](#)
- ▶ [IGMP Snooping Enhancements](#)
- ▶ [IGMP Snooping Querier](#)
- ▶ [IGMP Snooping Multicasts](#)

5.4.1 IGMP Snooping Global

This dialog allows you to enable the *IGMP Snooping* protocol in the device and also configure it for each port and each VLAN.

■ Operation

| Parameters | Meaning |
|------------|--|
| Operation | <p>Enables/disables the <i>IGMP Snooping</i> function in the device.</p> <p>Possible values:</p> <ul style="list-style-type: none"> ▶ On The <i>IGMP Snooping</i> function is enabled in the device according to RFC 4541 (Considerations for Internet Group Management Protocol (IGMP) and Multicast Listener Discovery (MLD) Snooping Switches). ▶ Off (default setting) The <i>IGMP Snooping</i> function is disabled in the device. The device transmits received query, report, and leave data packets without evaluating them. Received data packets with a Multicast destination address are transmitted to every port by the device. |

■ Information

| Parameters | Meaning |
|-------------------------------------|---|
| Multicast control packets processed | <p>Displays the number of Multicast control data packets processed. This statistic encompasses the following packet types:</p> <ul style="list-style-type: none"> – IGMP Reports – IGMP Queries version V1 – IGMP Queries version V2 – IGMP Queries version V3 – IGMP Queries with an incorrect version – PIM or DVMRP packets <p>The device uses the Multicast control data packets to create the address table for transmitting the Multicast data packets.</p> <p>Possible values:</p> <ul style="list-style-type: none"> ▶ $0..2^{31}-1$ <p>You use the <i>Reset IGMP snooping data</i> button in the <i>Basic Settings > Restart</i> dialog or the <code>clear igmp-snooping</code> CLI command to reset the IGMP Snooping entries, including the counter for the processed multicast control data packets.</p> |

■ Buttons

You find the description of the standard buttons in section [“Buttons” on page 18](#).

| Button | Meaning |
|---|--|
|  | Displays a sub menu with the following items. |
| Reset IGMP snooping counters | Removes the IGMP Snooping entries and resets the counter in the <i>Information</i> frame to 0. |

5.4.2 IGMP Snooping Configuration

This dialog allows you to enable the *IGMP Snooping* function in the device and also configure it for each port and each VLAN.

The dialog contains the following tabs:

- ▶ [VLAN ID]
- ▶ [Port]

[VLAN ID]

In this tab, you configure the *IGMP Snooping* function for every VLAN.

■ Table

| Parameters | Meaning |
|---------------------------|--|
| VLAN ID | Displays the ID of the VLAN to which the table entry applies. |
| Active | <p>Activates/deactivates the <i>IGMP Snooping</i> function for this VLAN. The prerequisite is that the <i>IGMP Snooping</i> function is globally enabled.</p> <p>Possible values:</p> <ul style="list-style-type: none"> ▶ <code>marked</code> IGMP Snooping is activated for this VLAN. The VLAN has joined the Multicast data stream. ▶ <code>unmarked</code> (default setting) IGMP Snooping is deactivated for this VLAN. The VLAN has left the Multicast data stream. |
| Group membership interval | <p>Specifies the time in seconds for which a VLAN from a dynamic Multicast group remains entered in the address table when the device does not receive any more report data packets from the VLAN.</p> <p>Specify a value larger than the value in the <i>Max. response time</i> column.</p> <p>Possible values:</p> <ul style="list-style-type: none"> ▶ <code>2..3600</code> (default setting: 260) |
| Max. response time | <p>Specifies the time in seconds in which the members of a multicast group should respond to a query data packet. For their response, the members specify a random time within the response time. You thus help prevent the multicast group members from responding to the query at the same time.</p> <p>Specify a value smaller than the value in the <i>Group membership interval</i> column.</p> <p>Possible values:</p> <ul style="list-style-type: none"> ▶ <code>1..25</code> (default setting: 10) |
| Fast leave admin mode | <p>Activates/deactivates the Fast Leave function for this VLAN.</p> <p>Possible values:</p> <ul style="list-style-type: none"> ▶ <code>marked</code> If the device receives an IGMP Leave message from a multicast group, when the Fast Leave function is active it removes the entry immediately from its address table. ▶ <code>unmarked</code> (default setting) When the Fast Leave function is inactive, the device first sends MAC-based queries to the members of the multicast group, and removes an entry when a VLAN does not send any more report messages. |
| MRP expiration time | <p>Multicast Router Present Expiration Time. Specifies the time in seconds for which the device waits for a query on this port that belongs to a VLAN. If the port does not receive a query data packet, the device removes the port from the list of ports with connected multicast routers. You have the option of configuring this parameter solely if the port belongs to an existing VLAN.</p> <p>Possible values:</p> <ul style="list-style-type: none"> ▶ <code>0</code> unlimited timeout - no expiration time ▶ <code>1..3600</code> (default setting: 260) |

■ Buttons

You find the description of the standard buttons in section [“Buttons” on page 18](#).

[Port]

In this tab, you configure the *IGMP Snooping* function for every port.

■ Table

| Parameters | Meaning |
|---------------------------|--|
| Port | Displays the port number. |
| Active | <p>Activates/deactivates the <i>IGMP Snooping</i> function for this port. The prerequisite is that the <i>IGMP Snooping</i> function is globally enabled.</p> <p>Possible values:</p> <ul style="list-style-type: none"> ▶ <i>marked</i> IGMP Snooping is active on this port. The device includes the port in the multicast data stream. ▶ <i>unmarked</i> (default setting) IGMP Snooping is inactive on this port. The port left the multicast data stream. |
| Group membership interval | <p>Specifies the time in seconds for which a port, from a dynamic multicast group, remains entered in the address table when the device does not receive any more report data packets from the port.</p> <p>Possible values:</p> <ul style="list-style-type: none"> ▶ 2..3600 (default setting: 260) <p>Specify the value larger than the value in the <i>Max. response time</i> column.</p> |
| Max. response time | <p>Specifies the time in seconds in which the members of a multicast group should respond to a query data packet. For their response, the members specify a random time within the response time. You thus help prevent the multicast group members from responding to the query at the same time.</p> <p>Possible values:</p> <ul style="list-style-type: none"> ▶ 1..25 (default setting: 10) <p>Specify a value lower than the value in the <i>Group membership interval</i> column.</p> |
| MRP expiration time | <p>Specifies the Multicast Router Present Expiration Time. The MRP expiration time is the time in seconds for which the device waits for a query packet on this port. If the port does not receive a query data packet, the device removes the port from the list of ports with connected multicast routers.</p> <p>Possible values:</p> <ul style="list-style-type: none"> ▶ 0 unlimited timeout - no expiration time ▶ 1..3600 (default setting: 260) |
| Fast leave admin mode | <p>Activates/deactivates the Fast Leave function for this port.</p> <p>Possible values:</p> <ul style="list-style-type: none"> ▶ <i>marked</i> If the device receives an IGMP Leave message from a multicast group, when the Fast Leave function is active it removes the entry immediately from its address table. ▶ <i>unmarked</i> (default setting) When the Fast Leave function is inactive, the device first sends MAC-based queries to the members of the multicast group, and removes an entry when a port does not send any more report messages. |
| Static query port | <p>Activates/deactivates the <i>Static query port</i> mode.</p> <p>Possible values:</p> <ul style="list-style-type: none"> ▶ <i>marked</i> The <i>Static query port</i> mode is active. The port is a static query port in the VLANs that are set up. ▶ <i>unmarked</i> (default setting) The <i>Static query port</i> mode is inactive. The port is not a static query port. The device transmits IGMP report messages to the port solely if it receives IGMP queries. |
| VLAN IDs | Displays the ID of the VLANs to which the table entry applies. |

■ Buttons

You find the description of the standard buttons in section [“Buttons” on page 18](#).

5.4.3 IGMP Snooping Enhancements

This dialog allows you to select a port for a VLAN ID and to configure the port.

Table

| Parameters | Meaning |
|---------------|--|
| VLAN ID | Displays the ID of the VLAN to which the table entry applies. |
| <Port number> | <p>Displays for every VLAN set up in the device whether the relevant port is a query port. Additionally, the field displays whether the device transmits every Multicast stream in the VLAN to this port.</p> <p>Possible values:</p> <ul style="list-style-type: none"> ▶ - The port is not a query port in this VLAN. ▶ L = Learned The device detected the port as a query port because the port received IGMP queries in this VLAN. The port is not a statically configured query port. ▶ A = Automatic The device detected the port as a query port. The prerequisite is that you configure the port as Learn by LLDP. ▶ S = Static (manual setting) A user specified the port as a static query port. The device transmits IGMP reports solely to ports on which it previously received IGMP queries – and to statically configured query ports. To assign this value, proceed as follows: <ul style="list-style-type: none"> <input type="checkbox"/> Open the <i>Wizard</i> window. <input type="checkbox"/> On the <i>Configuration</i> page, mark the <i>Static</i> checkbox. ▶ P = Learn by LLDP (manual setting) A user specified the port as Learn by LLDP. With the Link Layer Discovery Protocol (LLDP), the device detects Hirschmann devices connected directly to the port. The device denotes the detected query ports with A. To assign this value, proceed as follows: <ul style="list-style-type: none"> <input type="checkbox"/> Open the <i>Wizard</i> window. <input type="checkbox"/> On the <i>Configuration</i> page, mark the <i>Learn by LLDP</i> checkbox. ▶ F = Forward All (manual setting) A user specified the port so that the device transmits every received Multicast stream in the VLAN to this port. Use this setting for diagnostics purposes, for example. To assign this value, proceed as follows: <ul style="list-style-type: none"> <input type="checkbox"/> Open the <i>Wizard</i> window. <input type="checkbox"/> On the <i>Configuration</i> page, mark the <i>Forward all</i> checkbox. |

| Parameters | Meaning |
|--------------------|---|
| Display categories | <p>Enhances the clarity of the display. The table emphasizes the cells which contain the specified value. This helps to analyze and sort the table according to your needs.</p> <ul style="list-style-type: none"> ▶ Learned (L) The table displays cells which contain the value L and possibly further values. Cells which contain other values than L exclusively, the table displays with the “-“ symbol. ▶ Static (S) The table displays cells which contain the value S and possibly further values. Cells which contain other values than S exclusively, the table displays with the “-“ symbol. ▶ Automatic (A) The table displays cells which contain the value A and possibly further values. Cells which contain other values than A exclusively, the table displays with the “-“ symbol. ▶ Learn by LLDP The table displays cells which contain the value P and possibly further values. Cells which contain other values than P exclusively, the table displays with the “-“ symbol. ▶ Forward all (F) The table displays cells which contain the value F and possibly further values. Cells which contain other values than F exclusively, the table displays with the “-“ symbol. |

■ Buttons

You find the description of the standard buttons in section “Buttons” on page 18.

| Button | Meaning |
|---|--|
|  | Opens the <i>Wizard</i> window that helps you to select and configure the ports. |

[Wizard : Selection VLAN/Port]

After closing the *Wizard* window, click the button to save your settings.

■ Selection VLAN/Port

On this page you assign a VLAN ID to port.

| Parameters | Meaning |
|------------|---|
| VLAN ID | Select the ID of the VLAN. Possible values: ▶ 1..4042 |
| Port | Select the port. Possible values: ▶ <Port number> |

■ Configuration

On this page you specify the settings for the port.

| Parameters | Meaning |
|---------------|--|
| VLAN ID | Displays the ID of the selected VLAN. |
| Port | Displays the number of the selected port. |
| Static | Specifies the port as a static query port in the VLANs that are set up. The device transmits IGMP report messages to the ports at which it receives IGMP queries. Allows you to also transmit IGMP report messages to other selected ports (<i>enable</i>) or connected Hirschmann devices (<i>Automatic</i>). |
| Learn by LLDP | Specifies the port as <i>Learn by LLDP</i> . Allows directly connected Hirschmann devices to be detected via LLDP and learned as query ports. |
| Forward all | Specifies the port as <i>Forward all</i> . With the <i>Forward all</i> setting, the device transmits at this port every data packet with a Multicast address in the destination address field. |

5.4.4 IGMP Snooping Querier

The device allows you to send a Multicast stream solely to those ports to which a Multicast receiver is connected.

To determine which ports Multicast receivers are connected to, the device sends query data packets to the ports at a definable interval. If a Multicast receiver is connected, it joins the Multicast stream by responding to the device with a report data packet.

This dialog allows you to configure the Snooping Querier settings globally and for the VLANs that are set up.

■ Operation

| Parameters | Meaning |
|------------|---|
| Operation | Enables/disables the IGMP Querier function globally in the device. Possible values: ▶ On ▶ Off (default setting) |

■ Configuration

In this frame you specify the IGMP Snooping Querier settings for the general query data packets.

| Parameters | Meaning |
|---------------------|---|
| Protocol version | Specifies the IGMP version of the general query data packets. Possible values: ▶ 1 IGMP v1 ▶ 2 (default setting) IGMP v2 ▶ 3 IGMP v3 |
| Query interval [s] | Specifies the time in seconds after which the device generates general query data packets itself when it has received query data packets from the Multicast router. Possible values: ▶ 1..1800 (default setting: 60) |
| Expiry interval [s] | Specifies the time in seconds after which an active querier switches from the passive state back to the active state if it has not received any query packets for longer than specified here. Possible values: ▶ 60..300 (default setting: 125) |

■ Table

In the table you specify the Snooping Querier settings for the VLANs that are set up.

| Parameters | Meaning |
|------------|---|
| VLAN ID | Displays the ID of the VLAN to which the table entry applies. |

| Parameters | Meaning |
|----------------------|---|
| Active | <p>Activates/deactivates the IGMP Snooping Querier function for this VLAN.</p> <p>Possible values:</p> <ul style="list-style-type: none"> ▶ <code>marked</code> The IGMP Snooping Querier function is active for this VLAN. ▶ <code>unmarked</code> (default setting) The IGMP Snooping Querier function is inactive for this VLAN. |
| Current state | <p>Displays whether the Snooping Querier is active for this VLAN.</p> <p>Possible values:</p> <ul style="list-style-type: none"> ▶ <code>marked</code> The Snooping Querier is active for this VLAN. ▶ <code>unmarked</code> The Snooping Querier is inactive for this VLAN. |
| Address | <p>Specifies the IP address that the device adds as the source address in generated general query data packets. You use the address of the multicast router.</p> <p>Possible values:</p> <ul style="list-style-type: none"> ▶ Valid IPv4 address (default setting: <code>0.0.0.0</code>) |
| Protocol version | <p>Displays the IGMP protocol version of the general query data packets.</p> <p>Possible values:</p> <ul style="list-style-type: none"> ▶ 1 IGMP v1 ▶ 2 IGMP v2 ▶ 3 IGMP v3 |
| Max. response time | <p>Displays the time in seconds in which the members of a Multicast group should respond to a query data packet. For their response, the members specify a random time within the response time. This helps to prevent every Multicast group member to respond to the query at the same time.</p> |
| Last querier address | <p>Displays the IP address of the Multicast router from which the last received IGMP query was sent out.</p> |
| Last querier version | <p>Displays the IGMP version that the Multicast router used when sending out the last IGMP query received in this VLAN.</p> |

■ Buttons

You find the description of the standard buttons in section [“Buttons” on page 18](#).

5.4.5 IGMP Snooping Multicasts

The device allows you to specify how it transmits data packets with unknown Multicast addresses: Either the device discards these data packets, floods them to every port, or transmits them solely to the ports that previously received query packets.

The device also allows you to transmit the data packets with known Multicast addresses to the query ports.

■ Configuration

| Parameters | Meaning |
|--------------------|--|
| Unknown multicasts | <p>Specifies how the device transmits the data packets with unknown Multicast addresses.</p> <p>Possible values:</p> <ul style="list-style-type: none"> ▶ Discard The device discards data packets with an unknown MAC/IP Multicast address. ▶ Send to all ports (default setting) The device sends data packets with an unknown MAC/IP Multicast address to the registered ports. ▶ Send to query ports The device sends data packets with an unknown MAC/IP Multicast address to the query ports. |

■ Table

In the table you specify the settings for known Multicasts for the VLANs that are set up.

| Parameters | Meaning |
|------------------|--|
| VLAN ID | Displays the ID of the VLAN to which the table entry applies. |
| Known multicasts | <p>Specifies how the device transmits the data packets with known Multicast addresses.</p> <p>Possible values:</p> <ul style="list-style-type: none"> ▶ send to query and registered ports The device sends data packets with an unknown MAC/IP Multicast address to the query ports and to the registered ports. ▶ send to registered ports (default setting) The device sends data packets with an unknown MAC/IP Multicast address to registered ports. |

■ Buttons

You find the description of the standard buttons in section [“Buttons” on page 18](#).

5.5 MRP-IEEE

The IEEE 802.1ak amendment to the IEEE 802.1Q standard introduced the Multiple Registration Protocol (MRP) to replace the Generic Attribute Registration Protocol (GARP). The IEEE also modified and replaced the GARP applications, GARP Multicast Registration Protocol (GMRP) and GARP VLAN Registration Protocol (GVRP). The Multiple MAC Registration Protocol (MMRP) and the Multiple VLAN Registration Protocol (MVRP) replace these protocols.

MRP-IEEE helps confine traffic to the required areas of the LAN. To confine traffic, the MRP-IEEE applications distribute attribute values to participating MRP-IEEE devices across a LAN registering and de-registering multicast group membership and VLAN identifiers.

Registering group participants allows you to reserve resources for specific traffic transversing a LAN. Defining resource requirements regulates the level of traffic, allowing the devices to determine the required resources and provides for dynamic maintenance of the allocated resources.

The menu contains the following dialogs:

- ▶ [MRP-IEEE Configuration](#)
- ▶ [MRP-IEEE Multiple MAC Registration Protocol](#)
- ▶ [MRP-IEEE Multiple VLAN Registration Protocol](#)

5.5.1 MRP-IEEE Configuration

This dialog allows you to set the various MRP timers. By maintaining a relationship between the various timer values, the protocol operates efficiently and with less likelihood of unnecessary attribute withdraws and re-registration. The default timer values effectively maintain these relationships.

Maintain the following relationships when you reconfigure the timers:

- ▶ To allow for re-registration after a Leave or LeaveAll event, even if there is a lost message, specify the LeaveTime to: $\geq (2 \times \text{JoinTime}) + 60$.
- ▶ To minimize the volume of rejoining traffic generated following a LeaveAll event, specify the value for the LeaveAll timer larger than the LeaveTime value.

■ Table

| Parameters | Meaning |
|-------------------------|--|
| Port | Displays the port number. |
| Join time [1/100s] | Specifies the Join timer which controls the interval between transmit opportunities applied to the Applicant state machine. Possible values: ▶ 10..100 (default setting: 20) |
| Leave time [1/100s] | Specifies the Leave timer which controls the period that the Registrar state machine waits in the leave (LV) state before transiting to the empty (MT) state. Possible values: ▶ 20..600 (default setting: 60) |
| Leave all time [1/100s] | Specifies the LeaveAll timer which controls the frequency with which the LeaveAll state machine generates LeaveAll PDUs. Possible values: ▶ 200..6000 (default setting: 1000) |

■ Buttons

You find the description of the standard buttons in section [“Buttons” on page 18](#).

5.5.2 MRP-IEEE Multiple MAC Registration Protocol

The Multiple MAC Registration Protocol (MMRP) allows end devices and MAC switches to register and de-register group membership and individual MAC address information with switches located in the same LAN. The switches within the LAN disseminate the information through switches that support extended filtering services. Using the MAC address information, MMRP allows you to confine multicast traffic to the required areas of a Layer 2 network.

For an example of how MMRP works, consider a security camera mounted on a mast overlooking a building. The camera sends multicast packets onto a LAN. You have 2 end devices installed for surveillance in separate locations. You register the MAC addresses of the camera and the 2 end devices in the same multicast group. You then specify the MMRP settings on the ports to send the multicast group packets to the 2 end devices.

The dialog contains the following tabs:

- ▶ [\[Configuration \]](#)
- ▶ [\[Service requirement \]](#)
- ▶ [\[Statistics \]](#)

[Configuration]

In this tab, you select active MMRP port participants and set the device to transmit periodic events. The dialog also allows you to enable VLAN registered MAC address broadcasting.

A periodic state machine exists for each port and transmits periodic events regularly to the applicant state machines associated with active ports. Periodic events contain information indicating the status of the devices associated with the active port.

■ Operation

| Parameters | Meaning |
|------------|--|
| Operation | <p>Enables/disables the global MMRP function on the device. The device participates in MMRP message exchanges.</p> <p>Possible values:</p> <ul style="list-style-type: none"> ▶ On The device is a normal participant in MMRP message exchanges. ▶ Off (default setting) The device ignores MMRP messages. |

■ Configuration

| Parameters | Meaning |
|------------------------|---|
| Periodic state machine | <p>Enables/disables the global periodic state machine on the device.</p> <p>Possible values:</p> <ul style="list-style-type: none"> ▶ On With MMRP <i>Operation</i> enabled globally, the device transmits MMRP messages in one-second intervals, on MMRP participating ports. ▶ Off (default setting) Disables the periodic state machine on the device. |

■ Table

| Parameters | Meaning |
|-------------------------------|---|
| Port | Displays the port number. |
| Active | <p>Activates/deactivates the port MMRP participation.</p> <p>Possible values:</p> <ul style="list-style-type: none"> ▶ marked (default setting) With MMRP enabled globally and on this port, the device sends and receives MMRP messages on this port. ▶ unmarked Disables the port MMRP participation. |
| Restricted group registration | <p>Activates/deactivates the restriction of dynamic MAC address registration using MMRP on the port.</p> <p>Possible values:</p> <ul style="list-style-type: none"> ▶ marked When enabled and a static filter entry for the MAC address exists on the VLAN concerned, then the device allows the dynamic registration of MAC address attributes. ▶ unmarked (default setting) Activates/deactivates the restriction of dynamic MAC address registration using MMRP on the port. |

■ **Buttons**

You find the description of the standard buttons in section [“Buttons” on page 18](#).

[Service requirement]

This tab contains forwarding parameters for each active VLAN, specifying the ports on which multicast forwarding applies. The device allows you to statically setup VLAN ports as `Forward all` or `Forbidden`. You set the Forbidden MMRP service requirement statically through the graphical user interface or CLI exclusively.

A port is setup solely as ForwardAll or Forbidden.

■ Table

| Parameters | Meaning |
|---------------|--|
| VLAN ID | Displays the ID of the VLAN. |
| <Port number> | Specifies the service requirement handling for the port. Possible values: <ul style="list-style-type: none">▶ <code>FA</code> Specifies the ForwardAll traffic setting on the port. The device forwards traffic destined to MMRP registered multicast MAC addresses on the VLAN. The device forwards traffic to ports which MMRP has dynamically setup or ports which the administrator has statically setup as ForwardAll ports.▶ <code>F</code> Specifies the Forbidden traffic setting on the port. The device blocks dynamic MMRP ForwardAll service requirements. With ForwardAll requests blocked on this port in this VLAN, the device blocks traffic destined to MMRP registered multicast MAC addresses on this port. Furthermore, the device blocks MMRP service request for changing this value on this port.▶ <code>-</code> (default setting) Disables the forwarding functions on this port.▶ <code>Learned</code> Displays values setup by MMRP service requests. |

■ Buttons

You find the description of the standard buttons in section [“Buttons” on page 18](#).

[Statistics]

Devices on a LAN exchange Multiple MAC Registration Protocol Data Units (MMRPDU) to maintain statuses of devices on an active MMRP port. This tab allows you to monitor the MMRP traffic statistics for each port.

■ Information

| Parameters | Meaning |
|-------------------------|---|
| Transmitted MMRP PDU | Displays the number of MMRPDUs transmitted on the device. |
| Received MMRP PDU | Displays the number of MMRPDUs received on the device. |
| Received bad header PDU | Displays the number of MMRPDUs received with a bad header on the device. |
| Received bad format PDU | Displays the number of MMRPDUs with a bad data field that were not transmitted on the device. |
| Transmission failed | Displays the number of MMRPDUs not transmitted on the device. |

■ Table

| Parameters | Meaning |
|---------------------------|---|
| Port | Displays the port number. |
| Transmitted MMRP PDU | Displays the number of MMRPDUs transmitted on the port. |
| Received MMRP PDU | Displays the number of MMRPDUs received on the port. |
| Received bad header PDU | Displays the number of MMRPDUs with a bad header that were received on the port. |
| Received bad format PDU | Displays the number of MMRPDUs with a bad data field that were not transmitted on the port. |
| Transmission failed | Displays the number of MMRPDUs not transmitted on the port. |
| Last received MAC address | Displays the last MAC address from which the port received MMRPPDUs. |

■ Buttons

You find the description of the standard buttons in section [“Buttons” on page 18](#).

| Button | Meaning |
|---|--|
|  | Displays a sub menu with the following items. |
| Reset | Resets the port statistics counters and the values in the <i>Last received MAC address</i> column. |

5.5.3 MRP-IEEE Multiple VLAN Registration Protocol

The Multiple VLAN Registration Protocol (MVRP) provides a mechanism that allows you to distribute VLAN information and configure VLANs dynamically. For example, when you configure a VLAN on an active MVRP port, the device distributes the VLAN information to other MVRP enabled devices. Using the information received, an MVRP enabled device dynamically creates the VLAN trunks on other MVRP enabled devices as needed.

The dialog contains the following tabs:

- ▶ [\[Configuration\]](#)
- ▶ [\[Statistics\]](#)

[Configuration]

In this tab, you select active MVRP port participants and set the device to transmit periodic events.

A periodic state machine exists for each port and transmits periodic events regularly to the applicant state machines associated with active ports. Periodic events contain information indicating the status of the VLANs associated with the active port. Using the periodic events, MVRP enabled switches dynamically maintain the VLANs.

■ Operation

| Parameters | Meaning |
|------------|---|
| Operation | <p>Enables/disables the global Applicant Administrative Control which specifies whether the Applicant state machine participates in MMRP message exchanges.</p> <p>Possible values:</p> <ul style="list-style-type: none"> ▶ On Normal Participant. The Applicant state machine participates in MMRP message exchanges. ▶ Off (default setting) Non-Participant. The Applicant state machine ignores MMRP messages. |

■ Configuration

| Parameters | Meaning |
|------------------------|--|
| Periodic state machine | <p>Enables/disables the periodic state machine on the device.</p> <p>Possible values:</p> <ul style="list-style-type: none"> ▶ On The periodic state machine is enabled. With MVRP <i>Operation</i> enabled globally, the device transmits MVRP periodic events in 1 second intervals, on MVRP participating ports. ▶ Off (default setting) The periodic state machine is disabled. Disables the periodic state machine on the device. |

■ Table

| Parameters | Meaning |
|------------------------------|--|
| Port | Displays the port number. |
| Active | <p>Activates/deactivates the port MVRP participation.</p> <p>Possible values:</p> <ul style="list-style-type: none"> ▶ marked (default setting) With MVRP enabled globally and on this port, the device distributes VLAN membership information to MVRP aware devices connected to this port. ▶ unmarked Disables the port MVRP participation. |
| Restricted VLAN registration | <p>Activates/deactivates the <i>Restricted VLAN registration</i> function on this port.</p> <p>Possible values:</p> <ul style="list-style-type: none"> ▶ marked When enabled and a static VLAN registration entry exists, then the device allows you to create a dynamic VLAN for this entry. ▶ unmarked (default setting) Disables the <i>Restricted VLAN registration</i> function on this port. |

■ **Buttons**

You find the description of the standard buttons in section [“Buttons” on page 18](#).

[Statistics]

Devices on a LAN exchange Multiple VLAN Registration Protocol Data Units (MVRPDU) to maintain statuses of VLANs on active ports. This tab allows you to monitor the MVRP traffic.

■ Information

| Parameters | Meaning |
|-------------------------|---|
| Transmitted MVRP PDU | Displays the number of MVRPDUs transmitted on the device. |
| Received MVRP PDU | Displays the number of MVRPDUs received on the device. |
| Received bad header PDU | Displays the number of MVRPDUs received with a bad header on the device. |
| Received bad format PDU | Displays the number of MVRPDUs with a bad data field that the device blocked. |
| Transmission failed | Displays the number of failures while adding a message into the MVRP queue. |
| Message queue failures | Displays the number of MVRPDUs that the device blocked. |

■ Table

| Parameters | Meaning |
|---------------------------|---|
| Port | Displays the port number. |
| Transmitted MVRP PDU | Displays the number of MVRPDUs transmitted on the port. |
| Received MVRP PDU | Displays the number of MVRPDUs received on the port. |
| Received bad header PDU | Displays the number of MVRPDUs with a bad header that the device received on the port. |
| Received bad format PDU | Displays the number of MVRPDUs with a bad data field that the device blocked on the port. |
| Transmission failed | Displays the number of MVRPDUs that the device blocked on the port. |
| Registrations failed | Displays the number of failed registration attempts on the port. |
| Last received MAC address | Displays the last MAC address from which the port received MMRPDUs. |

■ Buttons

You find the description of the standard buttons in section [“Buttons” on page 18](#).

| Button | Meaning |
|---|--|
|  | Displays a sub menu with the following items. |
| Reset | Resets the port statistics counters and the values in the <i>Last received MAC address</i> column. |

5.6 QoS/Priority

Communication networks transmit a number of applications at the same time that have different requirements as regards availability, bandwidth and latency periods.

QoS (Quality of Service) is a procedure defined in IEEE 802.1D. It is used to distribute resources in the network. You therefore have the possibility of providing minimum bandwidth for important applications. The prerequisite is that the end devices and the devices in the network support prioritized data transmission. Data packets with high priority are given preference when transmitted by devices in the network. You transfer data packets with lower priority when there are no data packets with a higher priority to be transmitted.

The device provides the following setting options:

- ▶ You specify how the device evaluates QoS/prioritization information for inbound data packets.
- ▶ For outbound packets, you specify which QoS/prioritization information the device writes in the data packet (for example priority for management packets, port priority).

Note: Disable flow control if you use the functions in this menu. The flow control is inactive if in the *Switching > Global* dialog, *Configuration* frame the *Flow control* checkbox is unmarked.

The menu contains the following dialogs:

- ▶ [QoS/Priority Global](#)
- ▶ [QoS/Priority Port Configuration](#)
- ▶ [802.1D/p Mapping](#)
- ▶ [IP DSCP Mapping](#)
- ▶ [Queue Management](#)

5.6.1 QoS/Priority Global

The device allows you to maintain access to the management functions, even in situations with heavy utilization. In this dialog you specify the required QoS/priority settings.

■ Configuration

| Parameters | Meaning |
|--------------------------------------|---|
| VLAN priority for management packets | <p>Specifies the VLAN priority for sending management data packets. Depending on the VLAN priority, the device assigns the data packet to a specific traffic class and thus to a specific priority queue of the port.</p> <p>Possible values: ▶ 0..7 (default setting: 0)</p> <p>In the <i>Switching > QoS/Priority > 802.1D/p Mapping</i> dialog, you assign a traffic class to every VLAN priority.</p> |
| IP DSCP value for management packets | <p>Specifies the IP DSCP value for sending management data packets. Depending on the IP DSCP value, the device assigns the data packet to a specific traffic class and thus to a specific priority queue of the port.</p> <p>Possible values: ▶ 0 (be/cs0) .. 63 (default setting: 0 (be/cs0))</p> <p>Some values in the list also have a DSCP keyword, for example 0 (be/cs0) , 10 (af11) and 46 (ef) . These values are compatible with the IP precedence model.</p> <p>In the <i>Switching > QoS/Priority > IP DSCP Mapping</i> dialog you assign a traffic class to every IP DSCP value.</p> |
| Queues per port | <p>Displays the number of priority queues per port. The device has 4 priority queues per port. You assign every priority queue to a specific traffic class (traffic class according to IEEE 802.1D).</p> |

■ Buttons

You find the description of the standard buttons in section [“Buttons” on page 18](#).

5.6.2 QoS/Priority Port Configuration

In this dialog, you specify for every port how the device processes received data packets based on their QoS/priority information.

■ Table

| Parameters | Meaning |
|-------------------------|---|
| Port | Displays the port number. |
| Port priority | <p>Specifies what VLAN priority information the device writes into a data packet if the data packet contains no priority information. After this, the device transmits the data packet depending on the value specified in the <i>Trust mode</i> column.</p> <p>Possible values:</p> <ul style="list-style-type: none"> ▶ 0..7 (default setting: 0) |
| Trust mode | <p>Specifies how the device handles a received data packet if the data packet contains QoS/priority information.</p> <p>Possible values:</p> <ul style="list-style-type: none"> ▶ untrusted <p>The device transmits the data packet according to the priority specified in the <i>Port priority</i> column. The device ignores the priority information contained in the data packet.</p> <p>In the <i>Switching > QoS/Priority > 802.1D/p Mapping</i> dialog, you assign a traffic class to every VLAN priority.</p> ▶ trustDot1p (default setting) <p>The device transmits the data packet according to the priority information in the VLAN tag.</p> <p>In the <i>Switching > QoS/Priority > 802.1D/p Mapping</i> dialog, you assign a traffic class to every VLAN priority.</p> ▶ trustIpDscp <ul style="list-style-type: none"> – If the data packet is an IP packet: <p>The device transmits the data packet according to the IP DSCP value contained in the data packet.</p> <p>In the <i>Switching > QoS/Priority > IP DSCP Mapping</i> dialog you assign a traffic class to every IP DSCP value.</p> – If the data packet is not an IP packet: <p>The device transmits the data packet according to the priority specified in the <i>Port priority</i> column.</p> <p>In the <i>Switching > QoS/Priority > 802.1D/p Mapping</i> dialog, you assign a traffic class to every VLAN priority.</p> |
| Untrusted traffic class | <p>Displays the traffic class assigned to the VLAN priority information specified in the <i>Port priority</i> column. In the <i>Switching > QoS/Priority > 802.1D/p Mapping</i> dialog, you assign a traffic class to every VLAN priority.</p> <p>Possible values:</p> <ul style="list-style-type: none"> ▶ 0..3 |

■ Buttons

You find the description of the standard buttons in section [“Buttons” on page 18](#).

5.6.3 802.1D/p Mapping

The device transmits data packets with a VLAN tag according to the contained QoS/priority information with a higher or lower priority.

In this dialog, you assign a traffic class to every VLAN priority. You assign the traffic classes to the priority queues of the ports.

■ Table

| Parameters | Meaning |
|---------------|---|
| VLAN priority | Displays the VLAN priority. |
| Traffic class | Specifies the traffic class assigned to the VLAN priority. Possible values: ▶ 0..3 0 assigned to the priority queue with the lowest priority. 3 assigned to the priority queue with the highest priority. Note: Among other things redundancy mechanisms use the highest traffic class. Therefore, select another traffic class for application data. |

■ Buttons

You find the description of the standard buttons in section [“Buttons” on page 18](#).

■ Default assignment of the VLAN priority to traffic classes

| VLAN Priority | Traffic class | Content description according to IEEE 802.1D |
|---------------|---------------|--|
| 0 | 1 | Best Effort Normal data without prioritizing |
| 1 | 0 | Background Non-time critical data and background services |
| 2 | 0 | Standard Normal data |
| 3 | 1 | Excellent Effort Important data |
| 4 | 2 | Controlled Load Time-critical data with a high priority |
| 5 | 2 | Video Video transmission with delays and jitter < 100 ms |
| 6 | 3 | Voice Voice transmission with delays and jitter < 10 ms |
| 7 | 3 | Network Control Data for network management and redundancy mechanisms |

5.6.4 IP DSCP Mapping

The device transmits IP data packets according to the DSCP value contained in the data packet with a higher or lower priority.

In this dialog, you assign a traffic class to every DSCP value. You assign the traffic classes to the priority queues of the ports.

■ Table

| Parameters | Meaning |
|---------------|---|
| DSCP value | Displays the DSCP value. |
| Traffic class | Specifies the traffic class which is assigned to the DSCP value. Possible values: ▶ 0..3 0 assigned to the priority queue with the lowest priority. 3 assigned to the priority queue with the highest priority. |

■ Buttons

You find the description of the standard buttons in section [“Buttons” on page 18](#).

■ Default assignment of the DSCP values to traffic classes

| DSCP Value | DSCP Name | Traffic class |
|-------------------|------------------|---------------|
| 0 | Best Effort /CS0 | 1 |
| 1-7 | | 1 |
| 8 | CS1 | 0 |
| 9,11,13,15 | | 0 |
| 10,12,14 | AF11,AF12,AF13 | 0 |
| 16 | CS2 | 0 |
| 17,19,21,23 | | 0 |
| 18,20,22 | AF21,AF22,AF23 | 0 |
| 24 | CS3 | 1 |
| 25,27,29,31 | | 1 |
| 26,28,30 | AF31,AF32,AF33 | 1 |
| 32 | CS4 | 2 |
| 33,35,37,39 | | 2 |
| 34,36,38 | AF41,AF42,AF43 | 2 |
| 40 | CS5 | 2 |
| 41,42,43,44,45,47 | | 2 |
| 46 | EF | 2 |
| 48 | CS6 | 3 |
| 49-55 | | 3 |
| 56 | CS7 | 3 |

Switching

Switching > QoS/Priority > IP DSCP Mapping

| DSCP Value | DSCP Name | Traffic class |
|------------|-----------|---------------|
| 57-63 | | 3 |

5.6.5 Queue Management

This dialog allows you to enable and disable the *Strict priority* function for the traffic classes. When you disable the *Strict priority* function, the device processes the priority queues of the ports with "Weighted Fair Queuing".

■ Table

| Parameters | Meaning |
|--------------------|---|
| Traffic class | Displays the traffic class. |
| Strict priority | <p>Activates/deactivates the processing of the port priority queue with <i>Strict priority</i> for this traffic class.</p> <p>Possible values:</p> <ul style="list-style-type: none"> ▶ marked (default setting) <ul style="list-style-type: none"> The processing of the port priority queue with <i>Strict priority</i> is active. <ul style="list-style-type: none"> – The port sends data packets that are in the priority queue with the highest priority exclusively. If this priority queue is empty, the port sends data packets that are in the priority queue with the next lower priority. – The port sends data packets with a lower traffic class after the priority queues with a higher priority are empty. In unfavorable situations, the port never sends these data packets. – If you select this setting for a traffic class, the device enables the function also for traffic classes with a higher priority. – Use this setting for applications such as VoIP or video that require the least possible delay. ▶ unmarked <ul style="list-style-type: none"> The processing of the port priority queue with <i>Strict priority</i> is inactive. The device uses "Weighted Fair Queuing"/"Weighted Round Robin" (WRR) to process the port priority queue. <ul style="list-style-type: none"> – The device assigns a minimum bandwidth to each traffic class. – Even under a high network load the port transmits data packets with a low traffic class. – If you select this setting for a traffic class, the device disables the function also for traffic classes with a lower priority. |
| Min. bandwidth [%] | <p>Specifies the minimum bandwidth for this traffic class when the device is processing the priority queues of the ports with "Weighted Fair Queuing".</p> <p>Possible values:</p> <ul style="list-style-type: none"> ▶ 0..100 (default setting: 0 = the device does not reserve any bandwidth for this traffic class) <p>The value specified in percent refers to the available bandwidth on the port. When you disable the <i>Strict priority</i> function for every traffic class, the maximum bandwidth is available on the port for the "Weighted Fair Queuing".</p> <p>The maximum total of the assigned bandwidths is 100 %.</p> |

■ Buttons

You find the description of the standard buttons in section ["Buttons" on page 18](#).

5.7 VLAN

With VLAN (Virtual Local Area Network) you distribute the data traffic in the physical network to logical subnetworks. This provides you with the following advantages:

- ▶ High flexibility
 - With VLAN you distribute the data traffic to logical networks in the existing infrastructure. Without VLAN, it would be necessary to have additional devices and complicated cabling.
 - With VLAN you specify network segments independently of the location of the individual end devices.
- ▶ Improved throughput
 - In VLANs data packets can be transferred by priority. If the priority is high, the device transfers the data traffic of a VLAN preferentially, for example for time-critical applications such as VoIP phone calls.
 - The network load is considerably reduced if data packets and Broadcasts are distributed in small network segments instead of in the entire network.
- ▶ Increased security

The distribution of the data traffic among individual logical networks makes unwanted accessing more difficult and strengthens the system against attacks such as MAC Flooding or MAC Spoofing.

The device supports packet-based “tagged” VLANs according to the IEEE 802.1Q standard. The VLAN tagging in the data packet indicates the VLAN to which the data packet belongs.

The device transmits the tagged data packets of a VLAN exclusively via ports that are assigned to the same VLAN. This reduces the network load.

The device learns the MAC addresses for every VLAN separately (independent VLAN learning).

The device prioritizes the received data stream in the following sequence:

- ▶ Voice VLAN
- ▶ Port-based VLAN

The menu contains the following dialogs:

- ▶ [VLAN Global](#)
- ▶ [VLAN Configuration](#)
- ▶ [VLAN Port](#)
- ▶ [VLAN Voice](#)

5.7.1 VLAN Global

This dialog allows you to view general VLAN parameters for the device.

■ Configuration

| Parameters | Meaning |
|--------------|--|
| Max. VLAN ID | Highest ID assignable to a VLAN. See the <i>Switching > VLAN > Configuration</i> dialog. |
| VLANs (max.) | Displays the maximum number of VLANs possible. See the <i>Switching > VLAN > Configuration</i> dialog. |
| VLANs | Number of VLANs currently configured in the device. See the <i>Switching > VLAN > Configuration</i> dialog. The VLAN ID 1 is always present in the device. |

■ Buttons

You find the description of the standard buttons in section [“Buttons” on page 18](#).

| Button | Meaning |
|---|---|
|  | Displays a sub menu with the following items. |
| Clear... | Resets the VLAN settings of the device to the default setting. Caution: You loose your connection to the device if you have changed the VLAN ID for the management in the <i>Basic Settings > Network</i> dialog. |

5.7.2 VLAN Configuration

In this dialog, you manage the VLANs. To set up a VLAN, create a further row in the table. There you specify for each port if it transmits data packets of the respective VLAN and if the data packets contain a VLAN tag.

You distinguish between the following VLANs:

- ▶ The user sets up static VLANs.
- ▶ The device sets up dynamic VLANs automatically and removes them if the prerequisites cease to apply.

For the following functions the device creates dynamic VLANs:

- *MRP*: If you assign the ring ports a non-existing VLAN, then the device creates this VLAN.
- *MVRP*: The device creates a VLAN based on the messages of neighboring devices.

Note: The settings are effective solely if the VLAN Unaware Mode is disabled. See the *Switching* > Global dialog.

■ Table

| Parameters | Meaning |
|---------------|--|
| VLAN ID | ID of the VLAN. The device supports up to 16 VLANs simultaneously set up. Possible values: ▶ 1..4042 |
| Status | Displays how the VLAN is set up. Possible values: ▶ other VLAN 1 or VLAN set up using the <i>802.1X Port Authentication</i> function. See the <i>Network Security > 802.1X Port Authentication</i> dialog. ▶ permanent VLAN set up by the user. or VLAN set up using the <i>MRP</i> function. See the <i>Switching > L2-Redundancy > MRP</i> dialog. VLANs with this setting remain set up after a restart, if you save the changes in the non-volatile memory. ▶ dynamicMvrp VLAN set up using the <i>MVRP</i> function. See the <i>Switching > MRP-IEEE > MVRP</i> dialog. VLANs with this setting are write-protected. The device removes a VLAN from the table as soon as the last port leaves the VLAN. |
| Creation time | Displays the time of VLAN creation. The field displays the time stamp for the operating time (system uptime). |
| Name | Specifies the name of the VLAN. Possible values: ▶ Alphanumeric ASCII character string with 1..32 characters |

| Parameters | Meaning |
|---------------|---|
| <Port number> | <p>Specifies if the respective port transmits data packets of the VLAN and if the data packets contain a VLAN tag.</p> <p>Possible values:</p> <ul style="list-style-type: none"> ▶ - (default setting) The port is not a member of the VLAN and does not transmit data packets of the VLAN. ▶ T = Tagged The port is a member of the VLAN and transmits the data packets with a VLAN tag. You use this setting for uplink ports, for example. ▶ LT = Tagged Learned The port is a member of the VLAN and transmits the data packets with a VLAN tag. The device created the entry automatically based on the <i>GVRP</i> or <i>MVRP</i> function. ▶ F = Forbidden The port is not a member of the VLAN and does not transmit data packets of this VLAN. Additionally, the device prevents the port from becoming a VLAN member through the <i>MVRP</i> function. ▶ U = Untagged (default setting for VLAN 1) The port is a member of the VLAN and transmits the data packets without a VLAN tag. Use this setting if the connected device does not evaluate any VLAN tags, for example on end ports. ▶ LU = Untagged Learned The port is a member of the VLAN and transmits the data packets without a VLAN tag. The device created the entry automatically based on the <i>GVRP</i> or <i>MVRP</i> function. <p>Note: Verify that the port on which the network management station is connected is a member of the VLAN in which the device transmits the management data. In the default setting, the device transmits the management data on VLAN 1. Otherwise, the connection to the device terminates when you transfer the changes to the device. The management access to the device is possible exclusively using the CLI through the V.24 interface.</p> |

■ Buttons

You find the description of the standard buttons in section [“Buttons” on page 18](#).

| Button | Meaning |
|---|---|
|  | <p>Opens the <i>Create</i> window to add a new entry to the table. In the <i>VLAN ID</i> field, you specify the ID of the VLAN.</p> |

5.7.3 VLAN Port

In this dialog you specify how the device handles received data packets that have no VLAN tag, or whose VLAN tag differs from the VLAN ID of the port.

This dialog allows you to assign a VLAN to the ports and thus specify the port VLAN ID.

Additionally, you also specify for each port how the device transmits data packets when the VLAN Unaware mode is disabled if one of the following situations occurs:

- ▶ The port receives data packets without a VLAN tagging.
- ▶ The port receives data packets with VLAN priority information (VLAN ID 0, priority tagged).
- ▶ The VLAN tagging of the data packet differs from the VLAN ID of the port.

Note: The settings are effective solely if the VLAN Unaware Mode is disabled. See the *Switching > Global* dialog.

■ Table

| Parameters | Meaning |
|-------------------------|--|
| Port | Displays the port number. |
| Port-VLAN ID | <p>Specifies the ID of the VLAN which the devices assigns to data packets without a VLAN tag. The prerequisite is that you specify in the <i>Acceptable packet types</i> column the value <code>admitAll</code>.</p> <p>Possible values:</p> <ul style="list-style-type: none">▶ ID of a VLAN you set up (default setting: 1) <p>When you use the <i>MRP</i> function and you have not assigned a VLAN to the ring ports, you specify the value 1 here for the ring ports. Otherwise, the device assigns the value to the ring ports automatically.</p> |
| Acceptable packet types | <p>Specifies whether the port transmits or discards received data packets without a VLAN tag.</p> <p>Possible values:</p> <ul style="list-style-type: none">▶ <code>admitAll</code> (default setting) The port accepts data packets both with and without a VLAN tag.▶ <code>admitOnlyVlanTagged</code> The port accepts solely data packets tagged with a VLAN ID ≥ 1. |
| Ingress filtering | <p>Activates/deactivates the ingress filtering.</p> <p>Possible values:</p> <ul style="list-style-type: none">▶ <code>marked</code> The ingress filtering is active. The device compares the VLAN ID in the data packet with the VLANs of which the device is a member. See the <i>Switching > VLAN > Configuration</i> dialog. If the VLAN ID in the data packet matches one of these VLANs, the port transmits the data packet. Otherwise, the device discards the data packet.▶ <code>unmarked</code> (default setting) The ingress filtering is inactive. The device transmits received data packets without comparing the VLAN ID. Thus the port also transmits data packets with a VLAN ID of which the port is not a member. |

■ Buttons

You find the description of the standard buttons in section [“Buttons” on page 18](#).

5.7.4 VLAN Voice

Use the Voice VLAN feature to separate voice and data traffic on a port, by VLAN and/or priority. A primary benefit of Voice VLAN is safeguarding the quality of voice traffic when data traffic on the port is high.

The device detects VoIP phones using the Link Layer Discovery Protocol - Media Endpoint Discovery (LLDP-MED). The device then adds the appropriate port to the member set of the configured Voice VLAN. The member set is either tagged or untagged. Tagging depends on the Voice VLAN interface mode (VLAN ID, Dot1p, None, Untagged).

Another benefit of the Voice VLAN feature is that the VoIP phone obtains VLAN ID or priority information via LLDP-MED from the device. As a result, the VoIP phone sends voice data tagged as priority, or untagged. This depends on the configured Voice VLAN Interface mode. You activate Voice VLAN on the port which is connecting to the VoIP phone.

■ Operation

| Parameters | Meaning |
|------------|---|
| Operation | Enables/disables the voice VLAN function of the device globally. Possible values: ▶ On ▶ Off (default setting) |

■ Table

| Parameters | Meaning |
|-----------------|---|
| Port | Displays the port number. |
| Voice VLAN mode | Specifies whether the port transmits or discards received data packets without a voice VLAN tagging or with voice VLAN priority information. Possible values: ▶ disabled (default setting) Deactivates the voice VLAN function for this table entry ▶ none Allows IP telephone to use its own configuration for sending untagged voice traffic. ▶ vlan/dot1p-priority The port filters data packets of the voice VLAN using the vlan and dot1p priority tags. ▶ untagged The port filters data packets without a voice VLAN tag. ▶ vlan The port filters data packets of the voice VLAN using the vlan tag. ▶ dot1p-priority The port filters data packets of the voice VLAN using the dot1p priority tags. If you select this value, additionally specify a proper value in the <i>Priority</i> column. |

| Parameters | Meaning |
|-----------------------|--|
| Data priority mode | <p>Specifies the trust mode for the data traffic on the particular port. The device uses this mode for data traffic on the voice VLAN, when it detects a VoIP telephone and a PC and when these devices use the same cable for transmitting and receiving data.</p> <p>Possible values:</p> <ul style="list-style-type: none"> ▶ <code>trust</code> (default setting) Using this setting the data traffic processes with normal priority, if voice traffic is present on the interface. ▶ <code>untrust</code> If voice traffic is present and the <i>Voice VLAN mode</i> is set to <code>dot1p-priority</code>, the data traffic uses the priority 0. If the interface transmits data traffic exclusively, the data traffic uses the normal priority. |
| Status | <p>Displays the status of the Voice VLAN on the port.</p> <p>Possible values:</p> <ul style="list-style-type: none"> ▶ <code>marked</code> The Voice VLAN is enabled. ▶ <code>unmarked</code> The Voice VLAN is disabled. |
| VLAN ID | <p>Specifies the ID of the VLAN to which the table entry applies. To forward traffic to this VLAN ID using this filter, select in the <i>Voice VLAN mode</i> column the value <code>vlan</code>.</p> <p>Possible values:</p> <ul style="list-style-type: none"> ▶ <code>0..4042</code> |
| Priority | <p>Specifies the Voice VLAN Priority of the port. The prerequisite is that you specify in the <i>Voice VLAN mode</i> column the value <code>dot1p-priority</code>.</p> <p>Possible values:</p> <ul style="list-style-type: none"> ▶ <code>0..7</code> ▶ <code>none</code> Deactivates the Voice VLAN Priority of the port. |
| Bypass authentication | <p>Activates the Voice VLAN Authentication mode. If you deactivate the function and set the value in the <i>Voice VLAN mode</i> column to <code>dot1p-priority</code>, then voice devices require an authentication.</p> <p>Possible values:</p> <ul style="list-style-type: none"> ▶ <code>marked</code> (default setting) If you activated the function in the Dialog <i>Network Security > 802.1X Port Authentication > Global</i> dialog, set the <i>Port control</i> parameter for this port to the <code>multiClient</code> value before activating this function. The parameter <i>Port control</i> you find in the <i>Network Security > 802.1X Port Authentication > Global</i> dialog. ▶ <code>unmarked</code> |

■ Buttons

You find the description of the standard buttons in section [“Buttons” on page 18](#).

5.8 L2-Redundancy

The menu contains the following dialogs:

- ▶ MRP
- ▶ DLR
- ▶ PRP
- ▶ HSR
- ▶ Spanning Tree
- ▶ Link Aggregation
- ▶ Link Backup

5.8.1 MRP

The Media Redundancy Protocol (MRP) is a protocol that allows you to set up high-availability, ring-shaped network structures. An MRP ring with Hirschmann devices is made up of up to 100 devices that support the MRP protocol according to IEC 62439.

The ring structure of an MRP ring changes back into a line structure if a section fails. The maximum switching time can be configured.

The Ring Manager function of the device closes the ends of a backbone in a line structure to a redundant ring.

Note: *Spanning Tree* and Ring Redundancy have an effect on each other. Deactivate the *Spanning Tree* protocol for the ports connected to the MRP ring. See the *Switching > L2-Redundancy > Spanning Tree > Port* dialog.

■ Operation

| Parameters | Meaning |
|------------|--|
| Operation | Enables/disables the <i>MRP</i> function. After you configured the parameters for the MRP ring, enable the function here. Possible values: <ul style="list-style-type: none">▶ On The <i>MRP</i> function is enabled. After you configured the devices in the MRP ring, the redundancy is active.▶ Off (default setting) The <i>MRP</i> function is disabled. |

■ Ring port 1 /Ring port 2

| Parameters | Meaning |
|------------|---|
| Port | Specifies the number of the port that is operating as a ring port. Possible values: <ul style="list-style-type: none">▶ <Port number> Number of the ring port Note: If the device uses the software supporting Fast MRP, you cannot select a <i>Link Aggregation</i> port as a ring port. |
| Operation | Displays the operating status of the ring port. Possible values: <ul style="list-style-type: none">▶ forwarding The port is enabled, connection exists.▶ blocked The port is blocked, connection exists.▶ disabled The port is disabled.▶ not-connected No connection exists. |

| Parameters | Meaning |
|--------------|---|
| Fixed backup | <p>Activates/deactivates the backup port function for the <i>Ring port 2</i>.</p> <p>Note: The switch over to the primary port can exceed the maximum ring recovery time.</p> <p>Possible values:</p> <ul style="list-style-type: none"> ▶ <code>marked</code> The <i>Ring port 2</i> backup function is active. If the ring is closed, the ring manager reverts back to the primary ring port. ▶ <code>unmarked</code> (default setting) The <i>Ring port 2</i> backup function is inactive. If the ring is closed, the ring manager continues to send data on the secondary ring port. |

■ Configuration

| Parameters | Meaning |
|---------------|---|
| Ring manager | <p>Enables/disables the <i>Ring manager</i> function. If there is one device at each end of the line, you activate this function.</p> <p>Possible values:</p> <ul style="list-style-type: none"> ▶ <code>On</code> The <i>Ring manager</i> function is enabled. The device operates as a ring manager. ▶ <code>Off</code> (default setting) The <i>Ring manager</i> function is disabled. The device operates as a ring client. |
| Advanced mode | <p>Activates/deactivates the advanced mode for fast switching times.</p> <p>Possible values:</p> <ul style="list-style-type: none"> ▶ <code>marked</code> (default setting) Advanced mode active. MRP-capable Hirschmann devices support this mode. ▶ <code>unmarked</code> Advanced mode inactive. Select this setting if another device in the ring does not support this mode. |
| Ring recovery | <p>Specifies the maximum switching time in milliseconds for reconfiguration of the ring. This setting is effective if the device operates as a ring manager.</p> <p>Possible values:</p> <ul style="list-style-type: none"> ▶ <code>500ms</code> ▶ <code>200ms</code> (default setting) ▶ <code>30ms</code> ▶ <code>10ms</code> <p>Shorter switching times make greater demands on the response time of every individual device in the ring. Use values lower than <code>500ms</code> if the other devices in the ring also support this shorter switching time.</p> <p>Note: The switching times <code>30ms</code> and <code>10ms</code> are available for devices with an FPGA (hardware for extended functions). The product code indicates whether your device supports Fast MRP. In order to use the functions, load the device software supporting Fast MRP.</p> <p>Set the switching time to <code>10ms</code> only when you use up to 20 devices in the ring that support this switching time. If you use more than 20 of these devices, set the switching time to at least <code>30ms</code>.</p> |

| Parameters | Meaning |
|------------|---|
| VLAN ID | <p>Specifies the ID of the VLAN which you assign to the ring ports.</p> <p>Possible values:</p> <ul style="list-style-type: none"> ▶ 0 (default setting) No VLAN assigned. Assign in the <i>Switching > VLAN > Configuration</i> dialog to the ring ports for VLAN 1 the value U. ▶ 1..4042 VLAN assigned. If you assign to the ring ports a non-existing VLAN, the device creates this VLAN. In the <i>Switching > VLAN > Configuration</i> dialog, the device creates an entry in the table for the VLAN and assigns the value T to the ring ports. |

■ Information

| Parameters | Meaning |
|-------------|--|
| Information | <p>Displays messages for the redundancy configuration and the possible causes of errors.</p> <p>The following messages are possible if the device operates as a ring client or a ring manager:</p> <ul style="list-style-type: none"> ▶ Redundancy available The redundancy is set up. When a component of the ring is down, the redundant line takes over its function. ▶ Configuration error: Error on ringport link. Error in the cabling of the ring ports. <p>The following messages are possible if the device operates as a ring manager:</p> <ul style="list-style-type: none"> ▶ Configuration error: Packets from another ring manager received. Another device exists in the ring that operates as the ring manager. Enable the <i>Ring manager</i> function only on one device in the ring. ▶ Configuration error: Ring link is connected to wrong port. A line in the ring is connected with a different port instead of with a ring port. The device only receives test data packets on 1 ring port. |

■ Buttons

You find the description of the standard buttons in section [“Buttons” on page 18](#).

| Button | Meaning |
|---|--|
|  | Displays a sub menu with the following items. |
| Delete ring configuration | Disables the redundancy function and resets the settings in the dialog to the default setting. |

5.8.2 DLR

The Device Level Ring (DLR) protocol provides high network availability in a ring topology. The primary intent for the DLR protocol is implementation in EtherNet/IP end-devices that have 2 Ethernet ports and embedded Layer 2 switch technology. The DLR protocol provides network fault detection and reconfiguration to support demanding control applications.

The DLR network uses a ring supervisor to monitor the network. The ring supervisor controls data on the ring by sending data only on the primary ring port until a break in the ring occurs. When a break in the ring occurs, the ring supervisor unblocks the secondary port allowing the data to reach the ring participants located on the other side of the break.

To maintain control of the network, the active ring supervisor sends Beacon packets through both ports. The device allows you to specify the interval between consecutive Beacon packets. The Beacon packets help detect breaks in the ring, send Ring State messages to the participants, and also contain the following information:

- ▶ the precedence of the active ring supervisor
- ▶ the MAC address of the active ring supervisor
- ▶ the Beacon timeout
- ▶ the DLR VLAN ID

In the supervisor mode, the device also sends Announce packets, once every second, through the unblocked port only. The Announce packets also contain Ring State messages.

In the non-supervisor mode, the device functions as a Beacon-based participant. Upon receiving a Ring Fault State message from the active ring supervisor, the Beacon-based participant flushes its unicast MAC address table, and conducts a Neighbor Check. The Neighbor Check helps isolate a break between adjacent participants.

DLR uses a VLAN to distribute information contained in the Beacon Packet, to other ring participants as priority tagged. The default setting for the DLR VLAN ID is 0. VLAN ID is 0 is only set in this dialog. You use VLAN ID 0 in conjunction with the *VLAN unaware mode*.

Verify that the functions which directly affect the *DLR* function have the following settings:

| | |
|---------------|---|
| EtherNet/IP | <i>Advanced > Industrial Protocols > EtherNet/IP</i> dialog - <i>Operation</i> = On - <i>Write access</i> = marked |
| Spanning Tree | <i>Switching > L2-Redundancy > Spanning Tree > Global</i> dialog - <i>Operation</i> = Off |
| VLAN | <i>Switching > Global</i> dialog - <i>VLAN unaware mode</i> = marked |
| IGMP Snooping | <i>Switching > IGMP Snooping > Global</i> dialog - <i>Operation</i> = On <i>Switching > IGMP Snooping > Configuration</i> dialog, <i>Port</i> tab - <i>Active</i> = marked <i>Switching > IGMP Snooping > Snooping Enhancements</i> dialog - <i>DLR ring ports</i> = SF (Static and Forward all) <i>Switching > IGMP Snooping > Querier</i> dialog - <i>Operation</i> = On |

Note: *DLR* is available for devices with an FPGA (hardware for extended functions). The product code indicates whether your device supports *DLR*. In order to use the functions, load the device software supporting *DLR*.

The menu contains the following dialogs:

- ▶ [DLR Configuration](#)
- ▶ [DLR Statistics](#)

5.8.2.1 DLR Configuration

In this dialog, you specify the role of the device in the ring. When you specify the device as a ring supervisor, then the device sends Beacon packets containing its precedence for active ring supervisor candidacy. As active ring supervisor, the device monitors the ring for breaks, and sends configuration information to the ring participants.

■ Operation

| Parameters | Meaning |
|------------|--|
| Operation | <p>Enables/disables the <i>DLR</i> function globally.</p> <p>Possible values:</p> <ul style="list-style-type: none"> ▶ On (default setting) The <i>DLR</i> function is enabled. ▶ Off The <i>DLR</i> function is disabled. |

■ Table

| Parameters | Meaning |
|--------------------|---|
| Ring index | Displays the index number to which the table entry relates. |
| Name | <p>Specifies the name of the DLR ring.</p> <p>Possible values:</p> <ul style="list-style-type: none"> ▶ Alphanumeric ASCII character string with 0..255 characters |
| Ring port 1 | <p>Specifies the first of 2 ring ports used to connect the device to the DLR ring.</p> <p>Possible values:</p> <ul style="list-style-type: none"> ▶ <Port number> (default setting: 1/1) Select the port from the drop-down list. |
| Ring port 1 status | <p>Displays the status of ring port 1.</p> <p>Possible values:</p> <ul style="list-style-type: none"> ▶ disabled The port is disabled. To enable the port, open the <i>Basic Settings > Port</i> dialog, <i>Configuration</i> tab. In the <i>Port on</i> column, mark the appropriate checkbox. ▶ blocked The port is the secondary port, sending and receiving only Beacon packets. ▶ forwarding The port is the primary port, sending and receiving data, Beacon packets, and Announce packets. ▶ notConnected The port is physically unconnected. |
| Ring port 2 | <p>Specifies the second of 2 ring ports used to connect the device to the DLR ring.</p> <p>Possible values:</p> <ul style="list-style-type: none"> ▶ <Port number> (default setting: 1/2) Select the port from the drop-down list. |

| Parameters | Meaning |
|-----------------------|--|
| Ring port 2 status | <p>Displays the status of ring port 2.</p> <p>Possible values:</p> <ul style="list-style-type: none"> ▶ disabled The port is disabled. To enable the port, open the <i>Basic Settings</i> > <i>Port</i> dialog, <i>Configuration</i> tab. In the <i>Port on</i> column, mark the appropriate checkbox. ▶ blocked The port is the secondary port, sending and receiving only Beacon packets. ▶ forwarding The port is the primary port, sending and receiving data, Beacon packets, and Announce packets. ▶ notConnected The port is physically unconnected. |
| Supervisor active | <p>Activates/deactivates the supervisor function.</p> <p>Possible values:</p> <ul style="list-style-type: none"> ▶ marked (default setting) The device is configured as a ring supervisor. The device monitors the ring for breaks. If a break in the ring occurs, then the device unblocks and forwards data on the secondary port. ▶ unmarked The device is a Beacon-based ring participant. |
| Status | <p>Displays the status of the device in the DLR ring.</p> <p>Possible values:</p> <ul style="list-style-type: none"> ▶ backup Another device in the same ring is the active supervisor. ▶ supervisor This device is the active supervisor. ▶ node The device functions as a Beacon-based ring participant. ▶ nonDlr The device has detected that the network topology is something other than a ring using the DLR protocol. ▶ unsupported The configuration in the row is invalid. |
| Supervisor precedence | <p>Specifies the precedence value of the device for the ring supervisor selection. The device sends the value to other ring devices in the Beacon packets. When another ring supervisor is present on the same ring, the device with the higher value is selected active ring supervisor. If both values are the same, then the device with the higher MAC address becomes active supervisor.</p> <p>Possible values:</p> <ul style="list-style-type: none"> ▶ 0..255 (default setting: 0) A numerically higher value indicates a higher precedence. |
| Beacon interval [μs] | <p>Specifies the interval, in microseconds, at which the supervisor sends Beacon packets. The ring supervisor transmits a Beacon packet through both of its Ethernet ports once per Beacon interval. When the ring is intact, the device receives the Beacon packet on the opposite ports, and leaves the blocked port in the blocking mode.</p> <p>Possible values:</p> <ul style="list-style-type: none"> ▶ 400..100000 (default setting: 400) Lower interval times increase the recovery time. When the ring contains only DLR participants, use the following formula to calculate: Minimum value = 13 * Number of ring participants |
| Beacon timeout [μs] | <p>Specifies the amount of time, in microseconds, the device listens for Beacon packets. After the device times out the reception of a Beacon packet, it takes the appropriate action depending on its role as an active supervisor or ring participant.</p> <p>Possible values:</p> <ul style="list-style-type: none"> ▶ 1600..500000 (default setting: 1960) Set this value to at least 4 times the value specified in the <i>Beacon interval [μs]</i> column. When the ring contains only DLR participants, use the following formula to calculate: Maximum value = (Number of ring participants * (1 - 0.1) * 25) + (Number of ring participants * 0.1 * 137) |

| Parameters | Meaning |
|------------|--|
| VLAN ID | <p>Specifies the VLAN ID used to send the DLR protocol messages to the other devices on the ring. The active supervisor informs the ring participants which VLAN ID to use in the Beacon packets. Create and configure the VLAN in the <i>Switching > VLAN > Configuration</i> dialog.</p> <p>The prerequisite for setting the VLAN ID to 0 is that you activate the VLAN unaware mode. In the <i>Switching > Global</i> dialog, mark the <i>VLAN unaware mode</i> checkbox.</p> <p>Possible values:</p> <ul style="list-style-type: none"> ▶ 0..4042 (default setting: 0) |
| Active | <p>Activates/deactivates the DLR configuration.</p> <p>Possible values:</p> <ul style="list-style-type: none"> ▶ marked The DLR configuration is active. ▶ unmarked (default setting) The DLR configuration is inactive. |

■ Buttons

You find the description of the standard buttons in section “Buttons” on page 18.

| Button | Meaning |
|--|--|
|  | Displays a sub menu with the following items. |
| Service action | <p>Opens the <i>Service action</i> dialog to specify the DLR services that the device uses to help locate and clear detected faults.</p> <p>Possible values:</p> <ul style="list-style-type: none"> ▶ <code>verifyFaultLocation</code> (default setting) The supervisor verifies the fault location by retransmitting the <code>Locate_Fault</code> packet to ring participants. ▶ <code>clearRapidFaults</code> Clears the <code>Rapid Fault</code> condition where the ring supervisor detected a cycle of rapid ring faults. ▶ <code>restartSignOn</code> Restarts the <code>Sign On</code> process and refreshes the participants list. |

5.8.2.2 DLR Statistics

This dialog displays the status of the rings, the type of topology, number of participants, and other information to help you to analyze the network.

This dialog also displays a list of participating ring participants. The active ring supervisor gathers the information contained in the participants list using the `Sign_On` packet. If the participants list is too large, then the DLR Object returns, `Reply Data Too Large` (code 0x11).

The dialog contains the following tabs:

- ▶ [\[Status \]](#)
- ▶ [\[Participants \]](#)

[Status]

■ Table

| Parameters | Meaning |
|------------|---|
| Ring index | Displays the index number to which the table entry relates. |
| Capability | Displays the capabilities of the device. Possible values: <ul style="list-style-type: none">▶ <code>announce</code> The device is an announce-based ring participant.▶ <code>beacon</code> The device is capable of sending Beacon packets.▶ <code>supervisor</code> The device is capable of being a supervisor.▶ <code>gateway</code> The device is capable of being a gateway.▶ <code>flushTable</code> The device is capable of flushing the unicast MAC address table. |
| Status | Displays the status of the device in the DLR ring. Possible values: <ul style="list-style-type: none">▶ <code>backup</code> Another device in the same ring is the active supervisor.▶ <code>supervisor</code> This device is the active supervisor.▶ <code>node</code> The device functions as a Beacon-based ring participant.▶ <code>nonDlr</code> The device has detected that the network topology is something other than a ring using the DLR protocol.▶ <code>unsupported</code> The row parameters are invalid. |

| Parameters | Meaning |
|------------------------|---|
| Network topology | <p>Displays the current network topology mode.</p> <p>Possible values:</p> <ul style="list-style-type: none"> ▶ linear The network is linear. ▶ ring The network is a DLR ring. |
| Network status | <p>Displays the current network status.</p> <p>Possible values:</p> <ul style="list-style-type: none"> ▶ normal After the device receives Beacon packets on both ports, the supervisor transitions to the NORMAL_STATE, flushes the unicast MAC address table, and reconfigures a port to blocking. The device sends Beacon packets with the Ring State set to RING_NORMAL_STATE. The ring supervisor also sends an Announce packet out of the forwarding port, with the Ring State set to RING_NORMAL_STATE. ▶ ringFault The reasons for which the device displays the value are as follows: <ul style="list-style-type: none"> – Upon boot up, an enabled ring supervisor starts in the FAULT_STATE with both ports forwarding packets. – The device received a Beacon packet from another supervisor with a higher precedence. – Upon receipt of a Beacon packet with the Ring State set to RING_FAULT_STATE. When the device is in the FAULT_STATE, the ring supervisor continues to send Beacon packets, in order to detect ring restoration. ▶ loop The device has detected a loop in the network. ▶ partial The device detected a partial network fault where the Beacon packets are lost only in 1 direction. When the active ring supervisor detects a partial fault, it blocks traffic on 1 port and sets a status value in the DLR Object. The condition requires user intervention. ▶ rapidFault The device detected a rapid fault, 5 faults in a 30 second period. Rapid faults can lead to an instable network. When the active ring supervisor detects a rapid fault, it blocks traffic on 1 port and sets a status value in the DLR Object. The condition requires user intervention. To reset the device open the <i>Switching > L2-Redundancy > DLR > Configuration</i> dialog and set the value <code>clearRapidFaults</code> in the <i>Service</i> column. |
| Last status change | Displays the time, in seconds, since the network status last changed. |
| Participants | Displays the number of devices in the ring protocol participants list. |
| Supervisor IP address | Displays the IPv4 address assigned to the active supervisor. |
| Supervisor MAC address | Displays the MAC address of the active ring supervisor. |
| Supervisor precedence | Displays the precedence value of the active ring supervisor. |
| Faults | Displays the number of times that the device has detected a ring fault, since starting as either the active or the backup supervisor. |
| Port 1 IP address | Displays the IPv4 address assigned to port 1. |
| Port 1 MAC address | Displays the MAC address of last active ring participant on port 1. |
| Port 2 IP address | Displays the IPv4 address assigned to port 2. |
| Port 2 MAC address | Displays the MAC address of last active ring participant on port 2. |

■ Buttons

You find the description of the standard buttons in section [“Buttons” on page 18](#).



[Participants]

■ Table

| Parameters | Meaning |
|-------------|---|
| Index | Displays the index number to which the table entry relates. |
| Address | Displays the IP address of the participating ring participant. |
| MAC address | Displays the MAC address of the participating ring participant. |

■ Buttons

You find the description of the standard buttons in section [“Buttons” on page 18](#).

| Button | Meaning |
|---|---|
|  | Updates the fields with the values that are saved in the volatile memory (RAM) of the device. |
|  | Opens the online help. |

5.8.3 PRP

The Parallel Redundancy Protocol (PRP) is defined in the international standard IEC 62439-3. PRP uses 2 independent LANs with any ring, star, bus and mesh topologies, providing a high availability of network connections.

To connect the device to the PRP network, use 100 Mbit/s FDX on both of the specially marked ports, *Port A* and *Port B*.

The main advantage of PRP is that the destination node receives packets from the source as long as 1 LAN is available. The absence of the second LAN due to repairs or maintenance has no impact on the packet transmission.

The network device which connects the end devices to the network implements the PRP protocol. The Ethernet switches in both LANs are standard switches that are oblivious to PRP. A Double Attached Node implementing PRP (DANP) is a network device with PRP functionality and has 1 connection into each independent LAN. A Single Attached Node (SAN) is a standard Ethernet device with a single LAN interface directly connected to one of the redundant LANs. For this reason, a SAN is unable to use the redundant LAN.

A Redundancy Box (RedBox) is a network device which implements the PRP functionality for standard ethernet devices. A standard ethernet device when connected to a PRP network via a RedBox is a virtual DANP (VDAN). Many applications and devices used for signal and control functions or VoIP, for example, need an integrated dual PRP interface which delivers packets without interruption.

Note: *PRP* is available for devices with an FPGA (hardware for extended functions). The product code indicates whether your device supports *PRP*. In order to use the functions, load the device software supporting *PRP*.

Note: If the inter-frame gap is shorter than the latency between the 2 LANs, a frame-ordering mismatch can occur. Frame-ordering mismatch is a phenomenon of the PRP protocol. The only solution for avoiding a frame-ordering mismatch is to verify that the inter-frame gap is greater than the latency between the LANs.

The menu contains the following dialogs:

- ▶ [PRP Configuration](#)
- ▶ [PRP DAN/VDAN Table](#)
- ▶ [PRP Proxy Node Table](#)
- ▶ [PRP Statistics](#)

5.8.3.1 PRP Configuration

In this dialog, you enable/disable the *PRP* function, and configure PRP supervision packet reception and transmission.

The *MRP* and *Spanning Tree* functions cannot operate on the same ports as the *PRP* function. Disable the *MRP* function or choose different ports. Deactivate the *Spanning Tree* function on the PRP ports.

Note: If PRP is active, it uses the interfaces 1/1 and 1/2. As seen in the *Switching > VLAN*, *Switching > Rate Limiter* and *Switching > Filter for MAC Addresses* dialogs, the *PRP* function replaces the interfaces 1/1 and 1/2 with the interface prp/1. Configure the VLAN membership, the rate limiting, and the MAC filtering for the interface prp/1.

■ Operation

| Parameters | Meaning |
|------------|---|
| Operation | Enables/disables the <i>PRP</i> function. Possible values: <ul style="list-style-type: none">▶ On The <i>PRP</i> function is enabled globally. The device processes the data stream according to the set up when this function is active.▶ Off (default setting) The <i>PRP</i> function is disabled globally. To avoid network loops, disable the <i>PRP</i> function on <i>Port A</i> or <i>Port B</i> before disabling the <i>PRP</i> function globally. Note: When you use SFPs for PRP ports and the device only supports 100 Mbit/s, then the SFPs must support 100 Mbit/s. |

■ Port A

| Parameters | Meaning |
|--------------------|---|
| Physical port | Displays the number of the physical port which the device uses as the PRP <i>Port A</i> . |
| Port A admin state | Enables/disables the <i>PRP</i> function on the port. Possible values: <ul style="list-style-type: none">▶ On (default setting) The <i>PRP</i> function on the port is enabled.▶ Off The <i>PRP</i> function on the port is disabled. |

■ Port B

| Parameters | Meaning |
|--------------------|---|
| Physical port | Displays the number of the physical port which the device uses as the PRP <i>Port B</i> . |
| Port B admin state | <p>Enables/disables the <i>PRP</i> function on the port.</p> <p>Possible values:</p> <ul style="list-style-type: none"> ▶ On (default setting) The <i>PRP</i> function on the port is enabled. ▶ Off The <i>PRP</i> function on the port is disabled. |

■ Supervision packet receiver

| Parameters | Meaning |
|------------------------------|---|
| Evaluate supervision packets | <p>Activates/deactivates the analysis of the supervision packets.</p> <p>Possible values:</p> <ul style="list-style-type: none"> ▶ marked (default setting) The analysis of the supervision packets is activated. The device receives Supervision Packets and analyzes them. ▶ unmarked The analysis of the supervision packets is deactivated. The device receives supervision packets without analyzing them. |

■ Supervision packet sender

| Parameters | Meaning |
|-------------------|--|
| Active | <p>Enables/disables the transmission of supervision packets.</p> <p>Possible values:</p> <ul style="list-style-type: none"> ▶ On (default setting) The transmission of supervision packets is enabled. The RedBox transmits its own supervision packets. ▶ Off The transmission of supervision packets is disabled. |
| Send VDAN packets | <p>Activates/deactivates the transmission of VDAN supervision packets. The prerequisite is that you activate the <i>Supervision packet sender</i> first.</p> <p>Possible values:</p> <ul style="list-style-type: none"> ▶ marked (default setting) The transmission of VDAN supervision packets is active. The RedBox transmits both its own supervision packets and the supervision packets for the VDANs listed in the <i>PRP Proxy Node Table</i>. ▶ unmarked The transmission of VDAN supervision packets is inactive. |

■ Configuration

| Parameters | Meaning |
|------------|---|
| MTU | <p>Specifies the maximum allowed size of Ethernet packets on the interface in bytes.</p> <p>Possible values:</p> <ul style="list-style-type: none">▶ 1518..1530 (default setting: 1518) <p>With the setting 1518, the port transmits the Ethernet packets up to the following size:</p> <ul style="list-style-type: none">– 1518 bytes without VLAN tag (1514 bytes + 4 bytes CRC)– 1522 bytes with VLAN tag (1518 bytes + 4 bytes CRC) <p>This setting allows you to increase the size of the Ethernet packets for specific applications.</p> |
| Speed | <p>Specifies the speed of the PRP interface. The prerequisite is that both PRP member ports operate with the specified speed.</p> <p>Possible values:</p> <ul style="list-style-type: none">▶ 100Mbps (default setting)▶ 1Gbps |

■ Buttons

You find the description of the standard buttons in section [“Buttons” on page 18](#).

5.8.3.2 PRP DAN/VDAN Table

This dialog allows you to analyze the LANs. This is helpful for example, when the *Last seen A* counter of one port continually increases while the *Last seen B* counter remains the same (and the other way round). This condition indicates a loss of LAN connection.

DAN/VDAN means Double Attached Node / Virtual Double Attached Node.

■ Table

| Parameters | Meaning |
|------------------|---|
| Index | Displays the index number to which the table entry relates. |
| MAC address | Displays the MAC address of the node. |
| Last seen A | Displays the time between received first packets for this node on LAN A. When the counter threshold reaches 497 days, it restarts from 0. |
| Last seen B | Displays the time between received first packets for this node on LAN B. When the counter threshold reaches 497 days, it restarts from 0. |
| Remote node type | Displays the type of node. Possible values: ▶ redboxp Management ▶ vdanp Client |

■ Buttons

You find the description of the standard buttons in section [“Buttons” on page 18](#).

| Button | Meaning |
|---|---|
|  | Displays a sub menu with the following items. |
| Reset | Resets the entire table. |

5.8.3.3 PRP Proxy Node Table

This dialog informs you of the connected devices for which this device provides PRP redundancy.

Note: The Redbox supports up to 128 hosts. When attempt to support more than 128 with the Redbox, then device drops packets.

■ Table

| Parameters | Meaning |
|-------------|--|
| Index | Displays the index number to which the table entry relates. Possible values: ▶ 1..128 |
| MAC address | Displays the MAC address of the connected devices for which this device implements PRP redundancy. |

■ Buttons

You find the description of the standard buttons in section [“Buttons” on page 18](#).

| Button | Meaning |
|---|---|
|  | Displays a sub menu with the following items. |
| Reset | Resets the entire table. |

5.8.3.4 PRP Statistics

This dialog lists receive events for various MIB Managed Objects. Each entry represents link degradation for the MIB Managed Objects listed in the description column. The table lists how many times the event occurred for each path through the device. The Port A entries for example, specify the path between the transceiver, through the Link Redundancy Entity (LRE) to the UDP and TCP layers.

■ Table

| Parameters | Meaning |
|-------------|--|
| Description | Displays the MIB Managed Objects description to which the <i>Port A</i> , <i>Port B</i> , and <i>Interlink</i> entries refer. |
| Port A | Displays the number of MIB Managed Objects events on <i>Port A</i> . The device examines the traffic as it passes from receive transceiver A to the LRE. |
| Port B | Displays the number of MIB Managed Objects events on <i>Port B</i> . The device examines the traffic as it passes from receive transceiver B to the LRE. |
| Interlink | Displays the number of MIB Managed Objects events on the interlink. The counters are active for the MIB Managed Objects that pertain to the interlink. The other counters remain empty. A sample is made of the traffic as it passes from the LRE to the switch. |
| CPU port | Displays the number of MIB Managed Objects events on the CPU Port. There is one MIB Managed Object that pertains to the CPU Port. The other counters remain empty. A sample is made of the traffic as it passes from receive transceiver to the CPU. |

■ Buttons

You find the description of the standard buttons in section [“Buttons” on page 18](#).

| Button | Meaning |
|---|---|
|  | Displays a sub menu with the following items. |
| Reset | Resets the entire table. |

5.8.4 HSR

An HSR-based ring offers zero recovery time (HSR = High-availability Seamless Redundancy). HSR is suited for applications that demand high availability and short reaction times. For example, protection applications for electrical station automation and controllers for synchronized drives which require constant connection.

HSR Redundancy Boxes (RedBox) use 2 Ethernet ports operating in parallel to connect to a ring. An HSR RedBox operating in this configuration is a Doubly Attached Node implementing the HSR protocol (DANH). A standard ethernet device connected to the HSR ring through an HSR RedBox is a Virtual DANH (VDANH).

The transmitting HSR node or HSR RedBox sends twin packets, 1 in each direction, on the ring. For identification, the HSR node injects the twin packets with an HSR tag. The HSR tag consists of a port identifier, the length of the payload and a sequence number. In a normal operating ring, the destination HSR node or RedBox receives both packets within a certain time skew. An HSR node forwards the first packet to arrive to the upper layers and discards the second packet when it arrives. A RedBox on the other hand forwards the first packet to the VDANHs and discards the second packet when it arrives.

The device performs a specific role in the network. Configure a device as an HSR RedBox connecting standard ethernet devices to an HSR ring. Configure a device as an HSR node connecting a PRP LAN to an HSR ring.

A single HSR ring accommodates up to 7 PRP LANs. Configure the device to identify and tag the traffic addressed for the connected PRP LAN.

The number of HSR nodes in the ring should not exceed 50.

It is useful to limit the traffic injected into the HSR ring. If there are any third party devices with a higher latency in the ring, then the consequence is that you reduce the number of ring participants. Verify that the sum of bandwidths applied to the HSR nodes is less than 84 %.

Note: *HSR* is available for devices with an FPGA (hardware for extended functions). The product code indicates whether your device supports *HSR*. In order to use the functions, load the device software supporting *HSR*.

The menu contains the following dialogs:

- ▶ [HSR Configuration](#)
- ▶ [HSR DAN/VDAN Table](#)
- ▶ [HSR Proxy Node Table](#)
- ▶ [HSR Statistics](#)

5.8.4.1 HSR Configuration

In this dialog, you enable the *HSR* function, configure HSR supervision packets, and specify the function that the device executes in the HSR ring.

The *MRP* and *Spanning Tree* functions cannot operate on the same ports as the *HSR* function. Disable the *MRP* function or choose different ports. Deactivate the *Spanning Tree* function on the HSR ports.

Note: If HSR is active, it uses the interfaces 1/1 and 1/2. As seen in the *Switching > Rate Limiter* and *Switching > Filter for MAC Addresses* dialogs, the *HSR* function replaces the interfaces 1/1 and 1/2 with the interface `hsr/1`. Set up the VLAN membership and the rate limiting for the interface `hsr/1`.

■ Operation

| Parameters | Meaning |
|------------|--|
| Operation | <p>Enables/disables the <i>HSR</i> function globally.</p> <p>Possible values:</p> <ul style="list-style-type: none"> ▶ On The device processes the data stream according to the set up when this function is active. ▶ Off (default setting) <p>Note: When you use SFPs for HSR ports and the device only supports 100 Mbit/s, then the SFPs must support 100 Mbit/s.</p> |

■ Port A

| Parameters | Meaning |
|--------------------|---|
| Physical port | Displays the number of the physical port which the device uses as the HSR <i>Port A</i> . |
| Port A admin state | <p>Enables/disables the <i>HSR</i> function on the port.</p> <p>Possible values:</p> <ul style="list-style-type: none"> ▶ On (default setting) The <i>HSR</i> function on the port is enabled. ▶ Off The <i>HSR</i> function on the port is disabled. |

■ Port B

| Parameters | Meaning |
|--------------------|---|
| Physical port | Displays the number of the physical port which the device uses as the HSR <i>Port B</i> . |
| Port B admin state | <p>Enables/disables the <i>HSR</i> function on the port.</p> <p>Possible values:</p> <ul style="list-style-type: none"> ▶ On (default setting) The <i>HSR</i> function on the port is enabled. ▶ Off The <i>HSR</i> function on the port is disabled. |

■ Supervision packet receiver

| Parameters | Meaning |
|------------------------------|---|
| Evaluate supervision packets | <p>Activates/deactivates the supervision packet analysis.</p> <p>Possible values:</p> <ul style="list-style-type: none"> ▶ <code>marked</code> (default setting) Supervision packet analysis is active. The device receives supervision data packets and analyzes them. ▶ <code>unmarked</code> Supervision packet analysis is inactive. The device receives supervision data packets without analyzing them. |

■ Supervision packet sender

| Parameters | Meaning |
|-------------------|--|
| Active | <p>Enables/disables the transmission of supervision packets.</p> <p>Possible values:</p> <ul style="list-style-type: none"> ▶ <code>On</code> (default setting) The transmission of supervision packets is enabled. The RedBox transmits its own supervision packets. ▶ <code>Off</code> The transmission of supervision packets is disabled. |
| Send VDAN packets | <p>Activates/deactivates the transmission of VDAN supervision packets. The prerequisite is that you enable the transmission of supervision packets. See the Active field.</p> <p>Possible values:</p> <ul style="list-style-type: none"> ▶ <code>marked</code> The transmission of VDAN supervision packets is active. The RedBox transmits both its own supervision packets and the supervision packets for the VDANs listed in the <i>HSR Proxy Node Table</i>. ▶ <code>unmarked</code> (default setting) The transmission of VDAN supervision packets is inactive. |

■ HSR parameter

| Parameters | Meaning |
|------------|--|
| HSR mode | <p>Specifies the forwarding capacity of the device for unicast traffic.</p> <p>Possible values:</p> <ul style="list-style-type: none"> ▶ <code>modeh</code> (default setting) If the host functions as a proxy for a destination device, it removes unicast traffic from the ring and forwards it to the destination address. ▶ <code>modeu</code> If the host operates as a proxy for a destination device, it forwards unicast traffic around the ring and forwards it to the destination address. When the packets return to the source node it discards the unicast traffic. |

| Parameters | Meaning |
|---------------------|--|
| Switching node type | <p>Specifies the function that the device executes in the HSR ring.</p> <p>Possible values:</p> <ul style="list-style-type: none"> ▶ <code>hsrredboxsan</code> (default setting) You use this setting if you connect SANs to the device within a HSR ring. ▶ <code>hsrredboxprpa</code> You use this setting to connect the corresponding device with PRP LAN A. Furthermore, set the <i>Redbox identity</i> parameter for the corresponding network connection. ▶ <code>hsrredboxprpb</code> You use this setting to connect the corresponding device with PRP LAN B. Furthermore, set the <i>Redbox identity</i> parameter for the corresponding network connection. <p>Note: When you specify the value <code>hsrredboxprpa</code> or <code>hsrredboxprpb</code>, increase the MTU size on the interface. See the <i>Configuration</i> frame, <i>MTU</i> field. Also increase the MTU size of the ports connected with LAN A and B in the PRP networks by the same amount. See the <i>MTU</i> column in the <i>Basic Settings > Port</i> dialog, <i>Configuration</i> tab.</p> |
| Redbox identity | <p>Specifies the tags for the PRP LAN traffic.</p> <p>The parameter identifies and tags the data traffic for the PRP LAN that you connect to this device. The device identifies the traffic for up to 7 PRP LANs that you connect to the HSR ring.</p> <p>The prerequisite is that you set the <i>Switching node type</i> parameter to <code>hsrredboxprpa</code> or to <code>hsrredboxprpb</code>.</p> <p>Possible values:</p> <ul style="list-style-type: none"> ▶ <code>id1a</code> (default setting) Use this value to handle the HSR data traffic for LAN A in PRP network 1. ▶ <code>id1b</code> Use this value to handle the HSR data traffic for LAN B in PRP network 1. ▶ <code>id2a</code> Use this value to handle the HSR data traffic for LAN A in PRP network 2. ▶ <code>id2b</code> Use this value to handle the HSR data traffic for LAN B in PRP network 2. ▶ <code>id7a</code> Use this value to handle the HSR data traffic for LAN A in PRP network 7. ▶ <code>id7b</code> Use this value to handle the HSR data traffic for LAN B in PRP network 7. |

■ Buttons

You find the description of the standard buttons in section [“Buttons” on page 18](#).

5.8.4.2 HSR DAN/VDAN Table

This dialog allows you to analyze the LANs. This is helpful for example, when the *Last seen A* counter of one port continually increases while the *Last seen B* counter remains the same (and the other way round). This condition indicates a loss of LAN connection.

DAN/VDAN means Double Attached Node / Virtual Double Attached Node.

■ Table

| Parameters | Meaning |
|------------------|---|
| Index | Displays the index number to which the table entry relates. |
| MAC address | Displays the MAC address of the node. |
| Last seen A | Displays the time between received first packets for this node on LAN A. When the counter threshold reaches 497 days, it restarts from 0. |
| Last seen B | Displays the time between received first packets for this node on LAN B. When the counter threshold reaches 497 days, it restarts from 0. |
| Remote node type | Displays the type of node. Possible values: ▶ redboxh Management ▶ vdanh Client |

■ Buttons

You find the description of the standard buttons in section [“Buttons” on page 18](#).

| Button | Meaning |
|---|---|
|  | Displays a sub menu with the following items. |
| Reset | Resets the entire table. |

5.8.4.3 HSR Proxy Node Table

This dialog informs you of the connected devices for which this device provides HSR redundancy.

■ Table

| Parameters | Meaning |
|-------------|--|
| Index | Displays the index number to which the table entry relates. Possible values: ▶ 1..128 |
| MAC address | Displays the MAC addresses of the connected devices for which this device implements HSR redundancy. |

■ Buttons

You find the description of the standard buttons in section [“Buttons” on page 18](#).

| Button | Meaning |
|---|---|
|  | Displays a sub menu with the following items. |
| Reset | Resets the entire table. |

5.8.4.4 HSR Statistics

This dialog lists receive events for various MIB Managed Objects. Each entry represents link degradation for the MIB Managed Objects listed in the description column. The table lists how many times the event occurred for each path through the device. The Port A entries for example, specify the path between the transceiver, through the Link Redundancy Entity (LRE) to the UDP and TCP layers.

■ Table

| Parameters | Meaning |
|-------------|--|
| Description | Displays the MIB Managed Objects description to which the <i>Port A</i> , <i>Port B</i> , and <i>Interlink</i> entries refer. |
| Port A | Displays the number of MIB Managed Objects events on <i>Port A</i> . The device examines the traffic as it passes from receive transceiver A to the LRE. |
| Port B | Displays the number of MIB Managed Objects events on <i>Port B</i> . The device examines the traffic as it passes from receive transceiver B to the LRE. |
| Interlink | Displays the number of MIB Managed Objects events on the interlink. The counters are active for the MIB Managed Objects that pertain to the interlink. The other counters remain empty. A sample is made of the traffic as it passes from the LRE to the switch. |
| CPU port | Displays the number of MIB Managed Objects events on the CPU Port. There is one MIB Managed Object that pertains to the CPU Port. The other counters remain empty. A sample is made of the traffic as it passes from receive transceiver to the CPU. |

■ Buttons

You find the description of the standard buttons in section “Buttons” on page 18.

| Button | Meaning |
|---|---|
|  | Displays a sub menu with the following items. |
| Reset | Resets the entire table. |

5.8.5 Spanning Tree

The Spanning Tree Protocol (STP) is a protocol that deactivates redundant paths of a network in order to avoid loops. If a network component fails on the path, the device calculates the new topology and reactivates these paths.

The Rapid Spanning Tree Protocol enables fast switching to a newly calculated topology without interrupting existing connections. RSTP achieves average reconfiguration times of less than a second. When you use RSTP in a ring with 10 to 20 devices, you can achieve reconfiguration times in the order of milliseconds.

Note: If you connect the device to the network through twisted pair SFPs instead of through usual twisted pair ports, the reconfiguration of the network takes slightly longer.

The menu contains the following dialogs:

- ▶ [Spanning Tree Global](#)
- ▶ [Spanning Tree Port](#)

5.8.5.1 Spanning Tree Global

In this dialog, you enable/disable the *Spanning Tree* function and specify the bridge settings.

■ Operation

| Parameters | Meaning |
|------------|---|
| Operation | Enables/disables the Spanning Tree function on the device. Possible values: <ul style="list-style-type: none">▶ On (default setting)▶ Off The device behaves transparently. The device floods received Spanning Tree data packets like multicast data packets to the ports. |

■ Variant

| Parameters | Meaning |
|------------|---|
| Variant | Displays the protocol used for the <i>Spanning Tree</i> function: Possible values: <ul style="list-style-type: none">▶ rstp The protocol RSTP is active. With RSTP (IEEE 802.1Q-2005), the <i>Spanning Tree</i> function is effective in every VLAN that is set up. |

■ Traps

| Parameters | Meaning |
|------------|---|
| Send trap | Activates/deactivates the sending of SNMP traps in case of one of the following events: <ul style="list-style-type: none">– Another bridge takes over the root bridge role.– The topology changes. A port changes its <i>Port state</i> from <i>forwarding</i> into <i>discarding</i> or from <i>discarding</i> into <i>forwarding</i>. Possible values: <ul style="list-style-type: none">▶ marked▶ unmarked (default setting) The sending of SNMP traps is active. The sending of SNMP traps is inactive. |

■ Bridge configuration

| Parameters | Meaning |
|------------|---|
| Bridge ID | Displays the bridge ID of the device. The device with the numerically lowest bridge ID takes over the role of the root bridge in the network. Possible values: <ul style="list-style-type: none">▶ <Bridge priority> / <MAC address> Value in the <i>Priority</i> field / MAC address of the device |

| Parameters | Meaning |
|---|---|
| Priority | <p>Specifies the bridge priority of the device.</p> <p>Possible values: ▶ 0..61440 in steps of 4096 (default setting: 32768)</p> <p>Assign the lowest numeric priority in the network to the device to make it the root bridge.</p> |
| Hello time [s] | <p>Specifies the time in seconds between the sending of two configuration messages (Hello data packets).</p> <p>Possible values: ▶ 1..2 (default setting: 2)</p> <p>If the device takes over the role of the root bridge, the other devices in the network use the value specified here. Otherwise, the device uses the value specified by the root bridge. See the <i>Root information</i> frame.</p> <p>Due to the interaction with the <i>Tx holds</i> parameter, we recommend not changing the default setting.</p> |
| Forward delay [s] | <p>Specifies the delay time for the status change in seconds.</p> <p>Possible values: ▶ 4..30 (default setting: 15)</p> <p>If the device takes over the role of the root bridge, the other devices in the network use the value specified here. Otherwise, the device uses the value specified by the root bridge. See the <i>Root information</i> frame.</p> <p>In the RSTP protocol, the bridges negotiate a status change without a specified delay.</p> <p>The <i>Spanning Tree</i> protocol uses the parameter to delay the status change between the statuses <i>disabled</i>, <i>discarding</i>, <i>learning</i>, <i>forwarding</i>.</p> |
| <p>The parameters <i>Forward delay [s]</i> and <i>Max age</i> have the following relationship: $Forward\ delay\ [s] \geq (Max\ age/2) + 1$ If you enter values in the fields that contradict this relationship, the device replaces these values with the last valid values or with the default value.</p> | |
| Max age | <p>Specifies the maximum permissible branch length, for example the number of devices to the root bridge.</p> <p>Possible values: ▶ 6..40 (default setting: 20)</p> <p>If the device takes over the role of the root bridge, the other devices in the network use the value specified here. Otherwise, the device uses the value specified by the root bridge. See the <i>Root information</i> frame.</p> <p>The <i>Spanning Tree</i> protocol uses the parameter to specify the validity of STP-BPDUs in seconds.</p> |
| Tx holds | <p>Limits the maximum transmission rate for sending BPDUs.</p> <p>Possible values: ▶ 1..40 (default setting: 10)</p> <p>When the device sends a BPDU, it increments a counter on this port. When the counter reaches the value specified here, the port stops sending BPDUs. On the one hand, this reduces the load generated by RSTP, and on the other a loop may be caused when the device stops receiving BPDUs.</p> <p>The device decrements the counter by 1 every second. In the following second, the device sends a maximum of 1 new BPDU.</p> |

| Parameters | Meaning |
|------------------------------------|--|
| BPDU guard | <p>Activates/deactivates the BPDU Guard function on the device. With this function, the device helps protect your network from incorrect configurations, attacks with STP-BPDUs, and undesired topology changes.</p> <p>Possible values:</p> <ul style="list-style-type: none"> ▶ marked <ul style="list-style-type: none"> The <i>BPDU guard</i> is active. <ul style="list-style-type: none"> – The device applies the function to manually specified edge ports. For these ports, in the <i>Switching > L2-Redundancy > Spanning Tree > Port</i> dialog, <i>CIST</i> tab the checkbox in the <i>Admin edge port</i> column is marked. – If an edge port receives an STP-BPDU, the device disables the port. For this port, in the <i>Basic Settings > Port</i> dialog, <i>Configuration</i> tab the checkbox in the <i>Port on</i> column is unmarked. ▶ unmarked (default setting) <ul style="list-style-type: none"> The <i>BPDU guard</i> is inactive. <p>To reset the status of the port to the value <i>forwarding</i>, you proceed as follows:</p> <ul style="list-style-type: none"> <input type="checkbox"/> If the port is still receiving BPDUs: <ul style="list-style-type: none"> – In the <i>Switching > L2-Redundancy > Spanning Tree > Port</i> dialog, <i>CIST</i> tab unmark the checkbox in the <i>Admin edge port</i> column. or – In the <i>Switching > L2-Redundancy > Spanning Tree > Global</i> dialog, unmark the <i>BPDU guard</i> checkbox. <input type="checkbox"/> To re-enable the port again you use the <i>Auto-Disable</i> function. Alternatively, proceed as follows: <ul style="list-style-type: none"> – Open the <i>Basic Settings > Port</i> dialog, <i>Configuration</i> tab. – Mark the checkbox in the <i>Port on</i> column. |
| BPDU filter (all admin edge ports) | <p>Activates/deactivates the filtering of STP-BPDUs on every manually specified edge port. For these ports, in the <i>Switching > L2-Redundancy > Spanning Tree > Port</i> dialog, <i>CIST</i> tab the checkbox in the <i>Admin edge port</i> column is marked.</p> <p>Possible values:</p> <ul style="list-style-type: none"> ▶ marked <ul style="list-style-type: none"> The BPDU filter is active on every edge port. The function excludes these ports from <i>Spanning Tree</i> operations. <ul style="list-style-type: none"> – The device does not send STP-BPDUs on these ports. – The device drops any STP-BPDUs received on these ports. ▶ unmarked (default setting) <ul style="list-style-type: none"> The global BPDU filter is inactive. You have the option to explicitly activate the BPDU filter for single ports. See the <i>Port BPDU filter</i> column in the <i>Switching > L2-Redundancy > Spanning Tree > Port</i> dialog. |
| Auto-disable | <p>Activates/deactivates the <i>Auto-Disable</i> function for the parameters that <i>BPDU guard</i> is monitoring on the port.</p> <p>Possible values:</p> <ul style="list-style-type: none"> ▶ marked <ul style="list-style-type: none"> The <i>Auto-Disable</i> function for the <i>BPDU guard</i> is active. <ul style="list-style-type: none"> – The device disables an edge port when the port receives an STP-BPDU. The “Link status” LED for the port flashes 3× per period. – The <i>Diagnostics > Ports > Auto-Disable</i> dialog displays which ports are currently disabled due to the parameters being exceeded. – The <i>Auto-Disable</i> function reactivates the port automatically. For this you go to the <i>Diagnostics > Ports > Auto-Disable</i> dialog and specify a waiting period for the relevant port in the <i>Reset timer [s]</i> column. ▶ unmarked (default setting) <ul style="list-style-type: none"> The <i>Auto-Disable</i> function for the <i>BPDU guard</i> is inactive. |

■ Root information

| Parameters | Meaning |
|-------------------|--|
| Bridge ID | Displays the bridge ID of the current root bridge. Possible values: ▶ <Bridge priority> / <MAC address> |
| Priority | Displays the bridge priority of the current root bridge. Possible values: ▶ 0..61440 in steps of 4096 |
| Hello time [s] | Displays the time in seconds specified by the root bridge between the sending of two configuration messages (Hello data packets). Possible values: ▶ 1..2 The device uses this specified value. See the <i>Bridge configuration</i> frame. |
| Forward delay [s] | Specifies the delay time in seconds set up by the root bridge for status changes. Possible values: ▶ 4..30 The device uses this specified value. See the <i>Bridge configuration</i> frame. In the RSTP protocol, the bridges negotiate a status change without a specified delay. The <i>Spanning Tree</i> protocol uses the parameter to delay the status change between the statuses disabled, discarding, learning, forwarding. |
| Max age | Specifies the maximum permissible branch length set up by the root bridge, for example the number of devices to the root bridge. Possible values: ▶ 6..40 (default setting: 20) The <i>Spanning Tree</i> protocol uses the parameter to specify the validity of STP-BPDUs in seconds. |

■ Topology information

| Parameters | Meaning |
|----------------------------|--|
| Bridge is root | Displays whether the device currently has the role of the root bridge. Possible values: ▶ marked The device currently has the role of the root bridge. ▶ unmarked Another device currently has the role of the root bridge. |
| Root port | Displays the number of the port from which the current path leads to the root bridge. If the device takes over the role of the root bridge, the field displays the value 0. |
| Root path cost | Specifies the path cost for the path that leads from the root port of the device to the root bridge of the layer 2 network. Possible values: ▶ 0..200000000 If the value 0 is specified, the device takes over the role of the root bridge. |
| Topology changes | Displays how many times the device has put a port into the <i>forwarding</i> status via Spanning Tree since it was started. |
| Time since topology change | Displays the time since the last topology change. Possible values: ▶ <days, hours:minutes:seconds> |

■ **Buttons**

You find the description of the standard buttons in section [“Buttons” on page 18](#).

5.8.5.2 Spanning Tree Port

In this dialog, you activate the Spanning Tree function on the ports, specify edge ports, and specify the settings for various protection functions.

The dialog contains the following tabs:

- ▶ [CIST]
- ▶ [Guards]

[CIST]

In this tab, you have the option to activate the Spanning Tree function on the ports individually, specify the settings for edge ports, and view the current values. The abbreviation CIST stands for Common and Internal Spanning Tree.

Note: Deactivate the *Spanning Tree* function on the ports that are participating in other Layer 2 redundancy protocols. Otherwise the redundancy protocols may operate differently to the way intended. This can cause loops.

■ Table

| Parameters | Meaning |
|----------------|---|
| Port | Displays the port number. |
| STP active | <p>Activates/deactivates the Spanning Tree function on the port.</p> <p>Possible values:</p> <ul style="list-style-type: none"> ▶ marked (default setting) ▶ unmarked <p>If the <i>Spanning Tree</i> function is enabled in the device and disabled on the port, the port does not send STP-BPDUs and drops any STP-BPDUs received.</p> |
| Port state | <p>Displays the transmission status of the port.</p> <p>Possible values:</p> <ul style="list-style-type: none"> ▶ discarding The port is blocked and forwards STP-BPDUs exclusively. ▶ learning The port is blocked, but it learns the MAC addresses of received data packets. ▶ forwarding The port forwards data packets. ▶ disabled The port is inactive. See the <i>Basic Settings > Port</i> dialog, <i>Configuration</i> tab. ▶ manualFwd The <i>Spanning Tree</i> function is disabled on the port. The port forwards STP-BPDUs. ▶ notParticipate The port is not participating in STP. |
| Port role | <p>Displays the current role of the port in CIST.</p> <p>Possible values:</p> <ul style="list-style-type: none"> ▶ root Port with the cheapest path to the root bridge. ▶ alternate Port with the alternative path to the root bridge (currently interrupted). ▶ designated Port for the side of the tree averted from the root bridge. ▶ backup Port receives STP-BPDUs from its own device. ▶ disabled The port is inactive. See the <i>Basic Settings > Port</i> dialog, <i>Configuration</i> tab. |
| Port path cost | <p>Specifies the path costs of the port.</p> <p>Possible values:</p> <ul style="list-style-type: none"> ▶ 0..200000000 (default setting: 0) <p>If the value is 0, the device automatically calculates the path costs depending on the data rate of the port.</p> |
| Port priority | <p>Specifies the priority of the port.</p> <p>Possible values:</p> <ul style="list-style-type: none"> ▶ 16..240 in steps of 16 (default setting: 128) <p>This value represents the first 4 bits of the port ID.</p> |

| Parameters | Meaning |
|--------------------|---|
| Received bridge ID | <p>Displays the bridge ID of the device from which this port last received an STP-BPDU.</p> <p>Possible values:</p> <ul style="list-style-type: none"> ▶ For ports with the <i>designated</i> role, the device displays the information for the STP-BPDU last received by the port. This helps to diagnose the possible STP problems in the network. ▶ For the <i>alternate</i>, <i>backup</i>, <i>master</i>, and <i>root</i> port roles, in the stationary condition (static topology) this information is identical to the information of the <i>designated</i> port role. ▶ If a port has no connection, or if it has not received any STP-BPDUs yet, the device displays the values that the port would send with the <i>designated</i> role. |
| Received port ID | <p>Displays the port ID of the device from which this port last received an STP-BPDU.</p> <p>Possible values:</p> <ul style="list-style-type: none"> ▶ For ports with the <i>designated</i> role, the device displays the information for the STP-BPDU last received by the port. This helps to diagnose the possible STP problems in the network. ▶ For the <i>alternate</i>, <i>backup</i>, <i>master</i>, and <i>root</i> port roles, in the stationary condition (static topology) this information is identical to the information of the <i>designated</i> port role. ▶ If a port has no connection, or if it has not received any STP-BPDUs yet, the device displays the values that the port would send with the <i>designated</i> role. |
| Received path cost | <p>Displays the path cost that the higher-level bridge has from its root port to the root bridge.</p> <p>Possible values:</p> <ul style="list-style-type: none"> ▶ For ports with the <i>designated</i> role, the device displays the information for the STP-BPDU last received by the port. This helps to diagnose the possible STP problems in the network. ▶ For the <i>alternate</i>, <i>backup</i>, <i>master</i>, and <i>root</i> port roles, in the stationary condition (static topology) this information is identical to the information of the <i>designated</i> port role. ▶ If a port has no connection, or if it has not received any STP-BPDUs yet, the device displays the values that the port would send with the <i>designated</i> role. |
| Admin edge port | <p>Activates/deactivates the <i>Admin edge port</i> mode. Use the <i>Admin edge port</i> mode if the port is connected to an end device. This setting allows the edge port to change faster to the forwarding state after linkup and thus a faster accessibility of the end device.</p> <p>Possible values:</p> <ul style="list-style-type: none"> ▶ <i>marked</i> The <i>Admin edge port</i> mode is active. The port is connected to an end device. <ul style="list-style-type: none"> – After the connection is set up, the port changes to the <i>forwarding</i> status without changing to the <i>learning</i> status beforehand. – If the port receives an STP-BPDU, the device deactivates the port if the BPDU Guard function is active. See the <i>Switching > L2-Redundancy > Spanning Tree > Global</i> dialog. ▶ <i>unmarked</i> (default setting) The <i>Admin edge port</i> mode is inactive. The port is connected to another STP bridge. After the connection is set up, the port changes to the <i>learning</i> status before changing to the <i>forwarding</i> status, if applicable. |
| Auto edge port | <p>Activates/deactivates the automatic detection of whether you connect an end device to the port. The prerequisite is that the checkbox in the <i>Admin edge port</i> column is <i>unmarked</i>.</p> <p>Possible values:</p> <ul style="list-style-type: none"> ▶ <i>marked</i> (default setting) The automatic detection is active. After the installation of the connection, and after $1.5 \times \text{Hello time [s]}$ the device sets the port to the <i>forwarding</i> status (default setting 1.5×2 s) if the port has not received any STP-BPDUs during this time. ▶ <i>unmarked</i> The automatic detection is inactive. After the installation of the connection, and after <i>Max age</i> the device sets the port to the <i>forwarding</i> status. (default setting: 20 s) |
| Oper edge port | <p>Displays whether an end device or an STP bridge is connected to the port.</p> <p>Possible values:</p> <ul style="list-style-type: none"> ▶ <i>marked</i> An end device is connected to the port. The port does not receive any STP-BPDUs. ▶ <i>unmarked</i> An STP bridge is connected to the port. The port receives STP-BPDUs. |

| Parameters | Meaning |
|--------------------|--|
| Oper PointToPoint | <p>Displays whether the port is connected to an STP device via a direct full-duplex link.</p> <p>Possible values:</p> <ul style="list-style-type: none"> ▶ true The port is connected directly to an STP device via a full-duplex link. The direct, decentralized communication between 2 bridges enables short reconfiguration times. ▶ false The port is connected in another way, for example via a half-duplex link or via a hub. |
| Port BPDU filter | <p>Activates/deactivates the filtering of STP-BPDUs on the port explicitly. The prerequisite is that the port is a manually specified edge port. For these ports, the checkbox in the <i>Admin edge port</i> column is marked.</p> <p>Possible values:</p> <ul style="list-style-type: none"> ▶ marked The BPDU filter is active on the port. The function excludes the port from <i>Spanning Tree</i> operations. <ul style="list-style-type: none"> – The device does not send STP-BPDUs on the port. – The device drops any STP-BPDUs received on the port. ▶ unmarked (default setting) The BPDU filter is inactive on the port. You have the option to globally activate the BPDU filter for every edge port. See the <i>Switching > L2-Redundancy > Spanning Tree > Global</i> dialog, <i>Bridge configuration</i> frame. If the <i>BPDU filter (all admin edge ports)</i> checkbox is marked, then the BPDU filter is still active on the port. |
| BPDU filter status | <p>Displays whether or not the BPDU filter is active on the port.</p> <p>Possible values:</p> <ul style="list-style-type: none"> ▶ marked The BPDU filter is active on the port as a result of the following settings: <ul style="list-style-type: none"> – The checkbox in the <i>Port BPDU filter</i> column is marked. and/or <ul style="list-style-type: none"> – The checkbox in the <i>BPDU filter (all admin edge ports)</i> column is marked. See the <i>Switching > L2-Redundancy > Spanning Tree > Global</i> dialog, <i>Bridge configuration</i> frame. ▶ unmarked The BPDU filter is inactive on the port. |
| BPDU flood | <p>Activates/deactivates the <i>BPDU flood</i> mode on the port even if the <i>Spanning Tree</i> function is inactive on the port. The prerequisite is that the <i>BPDU flood</i> mode is also active for these ports.</p> <p>Possible values:</p> <ul style="list-style-type: none"> ▶ marked The <i>BPDU flood</i> mode is active. The device floods STP-BPDUs received on the port to the ports for which the <i>Spanning Tree</i> function is inactive. ▶ unmarked (default setting) The <i>BPDU flood</i> mode is inactive. |

■ Buttons

You find the description of the standard buttons in section [“Buttons” on page 18](#).

[Guards]

This tab allows you to specify the settings for various protection functions on the ports.

■ Table

| Parameters | Meaning |
|------------|--|
| Port | Displays the port number. |
| Root guard | <p>Activates/deactivates the monitoring of STP-BPDUs on the port. The prerequisite is that the <i>Loop guard</i> function is inactive.</p> <p>With this setting the device helps you protect your network from incorrect configurations or attacks with STP-BPDUs that try to change the topology. This setting is relevant solely for ports with the STP role <i>designated</i>.</p> <p>Possible values:</p> <ul style="list-style-type: none"> ▶ <i>marked</i> The monitoring of STP-BPDUs is active. <ul style="list-style-type: none"> – If the port receives an STP-BPDU with better path information to the root bridge, the device discards the STP-BPDU and sets the status of the port to the value <i>discarding</i> instead of to <i>root</i>. – If there are no STP-BPDUs with better path information to the root bridge, the device resets the status of the port after $2 \times \textit{Hello time [s]}$. ▶ <i>unmarked</i> (default setting) The monitoring of STP-BPDUs is inactive. |
| TCN guard | <p>Activates/deactivates the monitoring of "Topology Change Notifications" on the port. With this setting the device helps you protect your network from attacks with STP-BPDUs that try to change the topology.</p> <p>Possible values:</p> <ul style="list-style-type: none"> ▶ <i>marked</i> The monitoring of "Topology Change Notifications" is enabled. <ul style="list-style-type: none"> – The port ignores the Topology Change flag in received STP-BPDUs. – If the received BPDU contains other information that causes a topology change, the device processes the BPDU even if the TCN guard is enabled. Example: The device receives better path information for the root bridge. ▶ <i>unmarked</i> (default setting) The monitoring of "Topology Change Notifications" is disabled. If the device receives STP-BPDUs with a Topology Change flag, it deletes the address table of the port and forwards the Topology Change Notifications. |
| Loop guard | <p>Activates/deactivates the monitoring of loops on the port. The prerequisite is that the <i>Root guard</i> function is inactive.</p> <p>With this setting the device prevents loops if the port does not receive any more STP-BPDUs. Use this setting solely for ports with the STP role <i>alternate</i>, <i>backup</i> or <i>root</i>.</p> <p>Possible values:</p> <ul style="list-style-type: none"> ▶ <i>marked</i> The monitoring of loops is active. This prevents loops for example if you disable the Spanning Tree function on the remote device or if the connection is interrupted solely in the receiving direction. <ul style="list-style-type: none"> – If the port does not receive any STP-BPDUs for a while, the device sets the status of the port to the value <i>discarding</i> and the value in the <i>Loop state</i> column to <i>true</i>. – If the port then receives STP-BPDUs again, the device sets the status of the port to a value according to <i>Port role</i> and the value in the <i>Loop state</i> column to <i>false</i>. ▶ <i>unmarked</i> (default setting) The monitoring of loops is inactive. If the port does not receive any STP-BPDUs for a while, the device sets the status of the port to the value <i>forwarding</i>. |

| Parameters | Meaning |
|--------------------|---|
| Loop state | <p>Displays whether the loop state of the port is inconsistent.</p> <p>Possible values:</p> <ul style="list-style-type: none"> ▶ true <ul style="list-style-type: none"> The loop state of the port is inconsistent: <ul style="list-style-type: none"> – The port is not receiving any STP-BPDUs and the <i>Loop guard</i> function is enabled. – The device sets the state of the port to the value <i>discarding</i>. The device thus prevents any potential loops. ▶ false <ul style="list-style-type: none"> The loop state of the port is consistent. The port receives STP-BPDUs. |
| Trans. into loop | Displays how many times the device has set the value in the <i>Loop state</i> column from <i>false</i> to <i>true</i> . |
| Trans. out of loop | Displays how many times the device has set the value in the <i>Loop state</i> column from <i>true</i> to <i>false</i> . |
| BPDU guard effect | <p>Displays whether the port received an STP-BPDU as an edge port.</p> <p>Prerequisite:</p> <ul style="list-style-type: none"> – The port is a manually specified edge port. In the <i>Port</i> dialog, the checkbox for this port in the <i>Admin edge port</i> column is marked. – In the <i>Switching > L2-Redundancy > Spanning Tree > Global</i> dialog, the BPDU Guard function is active. <p>Possible values:</p> <ul style="list-style-type: none"> ▶ marked <ul style="list-style-type: none"> The port is an edge port and received an STP-BPDU. The device deactivates the port. For this port, in the <i>Basic Settings > Port</i> dialog, <i>Configuration</i> tab the checkbox in the <i>Port on</i> column is unmarked. ▶ unmarked <ul style="list-style-type: none"> The port is an edge port and has not received any STP-BPDUs, or the port is not an edge port. <p>To reset the status of the port to the value <i>forwarding</i>, you proceed as follows:</p> <ul style="list-style-type: none"> <input type="checkbox"/> If the port is still receiving BPDUs: <ul style="list-style-type: none"> – In the <i>CIST</i> tab, unmark the checkbox in the <i>Admin edge port</i> column. or – In the <i>Switching > L2-Redundancy > Spanning Tree > Global</i> dialog, unmark the <i>BPDU guard</i> checkbox. <input type="checkbox"/> To activate the port, proceed as follows: <ul style="list-style-type: none"> – Open the <i>Basic Settings > Port</i> dialog, <i>Configuration</i> tab. – Mark the checkbox in the <i>Port on</i> column. |

■ Buttons

You find the description of the standard buttons in section [“Buttons” on page 18](#).

5.8.6 Link Aggregation

IEEE 802.1ax defines a Link Aggregation Group (LAG) as the combining of 2 or more, full-duplex point-to-point links operating at the same rate, on a single switch to increase bandwidth. Furthermore, Link Aggregation provides for redundancy. When a link goes down, the remaining links in the LAG continue to forward the traffic.

Link Aggregation Control Protocol Data Units (LACPDUs) contain 2 fields with 8 binary bits of information each the Actor periodically sends to a Partner. The fields describe the state of the Actor and what the Actor knows about the Partner. The 8 bits contain information about the state of the Actor and Partner. The port transmits LACPDUs when in the active state. In the passive state, the port transmits LACPDUs solely when requested.

■ Table

| Parameters | Meaning |
|-------------------------|--|
| Trunk port | Displays the Link Aggregation port number. |
| Name | Specifies the name of the Link Aggregation Group. Possible values: ▶ Alphanumeric ASCII character string with 1..15 characters |
| Active | Activates/deactivates Link Aggregation Group. Possible values: ▶ <code>marked</code> (default setting) The LAG instance is in an „up“ state and processes traffic according to the specified values. ▶ <code>unmarked</code> The LAG instance, including the member ports, is in a "down" state. The member ports remain in the LAG instance and block traffic. |
| STP active | Activates/deactivates the <i>Spanning Tree</i> protocol on this LAG interface. After you create the Link Aggregation instance in the table the device automatically adds the port to the <i>Switching > L2-Redundancy > Spanning Tree > Port</i> dialog. Possible values: ▶ <code>marked</code> (default setting) Enabling the STP mode in this dialog also enables the port in the <i>Switching > L2-Redundancy > Spanning Tree > Port</i> dialog. ▶ <code>unmarked</code> Disabling the STP mode in this dialog also disables the port in the <i>Switching > L2-Redundancy > Spanning Tree > Port</i> dialog. The prerequisite is that you enable the function globally in the <i>Switching > L2-Redundancy > Spanning Tree > Global</i> dialog. |
| Static link aggregation | Activates/deactivates the <i>Static link aggregation</i> function on the LAG interface. Possible values: ▶ <code>marked</code> When enabled, the <i>Static link aggregation</i> function provides a stable network and the administrator manually propagates the aggregation status of the port. ▶ <code>unmarked</code> (default setting) The device propagates the aggregation status of the port automatically. |
| Active ports (min.) | Specifies how many active ports the device uses for the Link Aggregation group. Possible values: ▶ 1..2 (default setting: 2) ▶ 1..4 (default setting: 4) Note: The actual number of ports available depends on the device. |

| Parameters | Meaning |
|--------------------------------|--|
| Type | <p>Displays the type of group Link Aggregation used.</p> <p>Possible values:</p> <ul style="list-style-type: none"> ▶ <code>static</code> The device uses static aggregation on the port, <i>Static link aggregation</i> enabled. ▶ <code>dynamic</code> The device uses dynamic aggregation on the port, <i>Static link aggregation</i> disabled. |
| Send trap (Link up/down) | <p>Activates/deactivates the sending of SNMP traps when the device detects changes in the link up/down status on this interface.</p> <p>Possible values:</p> <ul style="list-style-type: none"> ▶ <code>marked</code> (default setting) The sending of SNMP traps is inactive. The device sends an SNMP trap when it detects a link up/down status change. ▶ <code>unmarked</code> The sending of SNMP traps is inactive. <p>The prerequisite for sending SNMP traps is that you enable the function in the <i>Diagnostics > Status Configuration > Alarms (Traps)</i> dialog and specify at least 1 trap destination.</p> |
| LACP admin key | <p>Specifies the administrative value of the local key on this LAG.</p> <p>The aggregator uses the administrative key to group links in a set. It is possible to have the administrative key value differ from the operational key value.</p> <p>Possible values:</p> <ul style="list-style-type: none"> ▶ <code>0..65535</code> (default setting: 0) |
| LACP collector max. delay [µs] | <p>Specifies the Frame Collector maximum delay time in microseconds.</p> <p>The LAG uses a Frame Collector to pass frames to the MAC client in the order that the port receives them. The collector delays either delivering the frame to its MAC client or discarding the frame according to this value.</p> <p>Possible values:</p> <ul style="list-style-type: none"> ▶ <code>0..65535</code> (default setting: 0) |
| Port | Displays the port members of the LAG instance. |
| Status | <p>Displays the LAG status of the port.</p> <p>Possible values:</p> <ul style="list-style-type: none"> ▶ <code>active</code> The port is actively participating in the LAG instance. ▶ <code>inactive</code> The port is a non-participant in the LAG instance. |
| LACP active | <p>Activates/deactivates LACP on this port.</p> <p>Possible values:</p> <ul style="list-style-type: none"> ▶ <code>marked</code> (default setting) The port actively participates in the LAG. ▶ <code>unmarked</code> The port is a non-participant in the LAG. |
| LACP port actor admin key | <p>Specifies the administrative key value for the aggregation port.</p> <p>The LAG uses keys to assign membership to local ports on the Actor device. Specify the same key value for the actor ports participating in the same LAG.</p> <p>Possible values:</p> <ul style="list-style-type: none"> ▶ <code>0..65535</code> (default setting: 0) When the port is in a LAG, then set this value to correspond with the LAG operational key. |

| Parameters | Meaning |
|-----------------------------|---|
| LACP actor admin state | <p>Specifies the administrative values of the Actor State transmitted in LACPDU. You have the option to combine the values with each other. This allows you administrative control over the LACPDU parameters. In the drop-down list, select one or more values.</p> <p>Possible values:</p> <ul style="list-style-type: none"> ▶ <code>lacpActivity</code> Specifies whether the port is an active or passive participant. An active participant transmits LACPDUs periodically. A passive participant transmits LACPDUs when requested. When selected you set the parameter to active participant. ▶ <code>lacpTimeout</code> The Actor periodically transmits LACPDUs at either a slow or fast transmission rate depending on the preference of the partner. You set the parameter to either long timeout or short timeout. When selected you set the parameter to short timeout. ▶ <code>aggregation</code> Specifies whether the port is a potential candidate for aggregation or for an individual link. When selected you set the parameter to aggregatable. ▶ <code>-</code> The state is unspecified. <p>When the parameter is unspecified the device displays the following values for the LACPDU parameters:</p> <ul style="list-style-type: none"> - <code>synchronization</code> The system considers this link to be allocated to the correct LAG, and the group is associated with a compatible aggregator. Furthermore, the identity of the LAG is consistent with the system ID, and operational key information transmitted. - <code>collecting</code> Collection of incoming frames on this link is definitely enabled. For example, collection is currently enabled and remains enabled in the absence of administrative changes or changes in the received protocol information. - <code>distributing</code> Distribution is currently disabled and remains disabled in the absence of administrative changes or changes in received protocol information. - <code>defaulted</code> The LACPDUs received by the actor is using the statically configured partner information. - <code>expired</code> The LACPDUs received by the actor is in the expired state. |
| LACP actor port priority | <p>Specifies the LACP actor port priority value for this port.</p> <p>Possible values:</p> <ul style="list-style-type: none"> ▶ <code>0..65535</code> (default setting: 128) The port with the lower value has the higher priority. |
| LACP partner port admin key | <p>Specifies the default value for the partner key, assigned by administrator or system policy for use when information about the partner is unknown or expired.</p> <p>The LAG uses keys to assign membership to partner ports. Specify the same key value for the local partners participating in the same LAG.</p> <p>Possible values:</p> <ul style="list-style-type: none"> ▶ <code>0..65535</code> (default setting: 0) If the port is alone in a LAG, then set this value to 0. When the port is in a LAG, then set this value to correspond with the LAG operational key. <p>To manage the partner ports, you use this parameter in conjunction with the settings in the following columns:</p> <ul style="list-style-type: none"> - <code>LACP partner admin port</code> - <code>LACP partner admin port priority</code> - <code>LACP partner admin SysID</code> - <code>LACP partner admin sys priority</code> |

| Parameters | Meaning |
|----------------------------------|--|
| LACP partner admin state | <p>Specifies the partner administrative state values. You have the option to combine the values with each other which allows you administrative control over the LACPDU parameters. In the drop-down list, select one or more values.</p> <p>Possible values:</p> <ul style="list-style-type: none"> ▶ <code>lacpActivity</code> Specifies whether the port is an active or passive participant. An active participant transmits LACPDU periodically. A passive participant transmits LACPDU when requested. When selected you set the parameter to active. ▶ <code>lacpTimeout</code> The Actor periodically transmits LACPDU at either a slow or fast transmission rate depending on the preference of the Partner either long timeout or short timeout. When selected you set the parameter to short timeout. ▶ <code>aggregation</code> Specifies whether the port is a potential candidate for aggregation or for an individual link. When selected you set the parameter to aggregatable. ▶ <code>-</code> The state is unspecified. <p>Possible values:</p> <ul style="list-style-type: none"> ▶ <code>synchronization</code> The system considers this link to be allocated to the correct LAG, and the group is associated with a compatible aggregator. Furthermore, the identity of the LAG is consistent with the system ID, and operational key information transmitted. ▶ <code>collecting</code> Collection of incoming frames on this link is definitely enabled. For example, collection is currently enabled and remains enabled in the absence of administrative changes or changes in the received protocol information. ▶ <code>distributing</code> Distribution is currently disabled and remains disabled in the absence of administrative changes or changes in received protocol information. ▶ <code>defaulted</code> The LACPDU received by the actor is using the statically configured partner information. ▶ <code>expired</code> The LACPDU received by the partner is in the expired state. |
| LACP partner admin port | <p>Specifies the port number of the partner port.</p> <p>Possible values:</p> <ul style="list-style-type: none"> ▶ <code>0..65535</code> (default setting: 0) <p>To manage the partner ports, you use this parameter in conjunction with the settings in the following columns:</p> <ul style="list-style-type: none"> - <i>LACP partner port admin key</i> - <i>LACP partner admin port priority</i> - <i>LACP partner admin SysID</i> - <i>LACP partner admin sys priority</i> |
| LACP partner admin port priority | <p>Specifies the port priority for the partner port.</p> <p>Possible values:</p> <ul style="list-style-type: none"> ▶ <code>0..65535</code> (default setting: 0) The port with the lower value has the higher priority. <p>To manage the partner ports, you use this parameter in conjunction with the settings in the following columns:</p> <ul style="list-style-type: none"> - <i>LACP partner port admin key</i> - <i>LACP partner admin port</i> - <i>LACP partner admin SysID</i> - <i>LACP partner admin sys priority</i> |

| Parameters | Meaning |
|---------------------------------|--|
| LACP partner admin SysID | <p>Specifies a MAC Address value representing the Partner System ID.</p> <p>Possible values:</p> <ul style="list-style-type: none"> ▶ Valid MAC address (default setting: 00:00:00:00:00:00) <p>To manage the partner ports, you use this parameter in conjunction with the settings in the following columns:</p> <ul style="list-style-type: none"> - <i>LACP partner port admin key</i> - <i>LACP partner admin port</i> - <i>LACP partner admin port priority</i> - <i>LACP partner admin sys priority</i> |
| LACP partner admin sys priority | <p>Specifies the default value for the system priority component of the system identifier of the partner, assigned by administrator or system policy for use when the information from the partner is unknown or expired.</p> <p>Possible values:</p> <ul style="list-style-type: none"> ▶ 0..65535 (default setting: 0) <p>The port with the lower value has the higher priority.</p> <p>To manage the partner ports, you use this parameter in conjunction with the settings in the following columns:</p> <ul style="list-style-type: none"> - <i>LACP partner port admin key</i> - <i>LACP partner admin port</i> - <i>LACP partner admin port priority</i> - <i>LACP partner admin SysID</i> |

■ Buttons

You find the description of the standard buttons in section [“Buttons” on page 18](#).

| Button | Meaning |
|---|---|
|  | <p>Opens the <i>Create</i> window to add a new entry to the table.</p> <ul style="list-style-type: none"> ▶ In the <i>Trunk port</i> drop-down list you select the port number of the Link Aggregation Group trunk. ▶ In the <i>Port</i> drop-down list you select the port to assign to the interface. |

5.8.7 Link Backup

With Link Backup, you configure pairs of redundant links. Each pair has a primary port and a backup port. The primary port forwards traffic until the device detects an error. When the device detects an error on the primary port, the Link Backup function transfers traffic over to the backup port.

The dialog also allows you to set a fail back option. When you enable the fail back function and the primary port returns to normal operation, the device first blocks traffic on the backup port and then forwards traffic on the primary port. This process helps protect the device from causing loops in the network.

■ Operation

| Parameters | Meaning |
|------------|---|
| Operation | Enables/disables the Link Backup function globally on the device. Possible values: <ul style="list-style-type: none">▶ On Enables the Link Backup function.▶ Off (default setting) Disables the Link Backup function. |

■ Table

| Parameters | Meaning |
|---------------------|---|
| Primary port | Displays the primary port of the interface pair. When you enable the Link Backup function this port is responsible for forwarding traffic. Possible values: <ul style="list-style-type: none">▶ Physical ports |
| Backup port | Displays the backup port on which the device forwards traffic when the device detects an error on the primary port. Possible values: <ul style="list-style-type: none">▶ Physical ports except for the port you set as the primary port. |
| Description | Specifies the Link Backup pair. Enter a name to identify the Backup pair. Possible values: <ul style="list-style-type: none">▶ Alphanumeric ASCII character string with 0..255 characters |
| Primary port status | Displays the status of the primary port for this Link Backup pair. Possible values: <ul style="list-style-type: none">▶ forwarding The link is up, no shutdown, and forwarding traffic.▶ blocking The link is up, no shutdown, and blocking traffic.▶ down The port is either link down, cable unplugged, or disabled in software, shutdown.▶ unknown The Link Backup feature is globally disabled, or the port pair is inactive. Therefore, the device ignores the port pair settings. |

| Parameters | Meaning |
|---------------------|---|
| Backup port status | <p>Displays the status of the Backup port for this Link Backup pair.</p> <p>Possible values:</p> <ul style="list-style-type: none"> ▶ forwarding The link is up, no shutdown, and forwarding traffic. ▶ blocking The link is up, no shutdown, and blocking traffic. ▶ down The port is either link down, cable unplugged, or disabled in software, shutdown. ▶ unknown The Link Backup feature is globally disabled, or the port pair is inactive. Therefore, the device ignores the port pair settings. |
| Fail back | <p>Activates/deactivates the automatic fail back.</p> <p>Possible values:</p> <ul style="list-style-type: none"> ▶ marked (default setting) The automatic fail back is active. After the delay timer expires, the backup port changes to <code>blocking</code> and the primary port changes to <code>forwarding</code>. ▶ unmarked The automatic fail back is inactive. The backup port continues forwarding traffic even after the primary port re-establishes a link or you manually change the admin status of the primary port from <code>shutdown</code> to <code>no shutdown</code>. |
| Fail back delay [s] | <p>Specifies the delay time in seconds that the device waits after the primary port re-establishes a link. Furthermore, this timer also applies when you manually set the admin status of the primary port from <code>shutdown</code> to <code>no shutdown</code>. After the delay timer expires, the backup port changes to <code>blocking</code> and the primary port changes to <code>forwarding</code>.</p> <p>Possible values:</p> <ul style="list-style-type: none"> ▶ 0..3600 (default setting: 30) <p>When set to 0, immediately after the primary port re-establishes a link, the backup port changes to <code>blocking</code> and the primary port changes to <code>forwarding</code>. Furthermore, immediately after you manually set the admin status of from <code>shutdown</code> to <code>no shutdown</code>, the backup port changes to <code>blocking</code> and the primary port changes to <code>forwarding</code>.</p> |
| Active | <p>Activates/deactivates the Link Backup pair configuration.</p> <p>Possible values:</p> <ul style="list-style-type: none"> ▶ marked The Link Backup pair is active. The device senses the link and administration status and forwards traffic according to the pair configuration. ▶ unmarked (default setting) The Link Backup pair is inactive. The ports forward traffic according to standard switching. |

■ Buttons

You find the description of the standard buttons in section [“Buttons” on page 18](#).

■ Create

| Parameters | Meaning |
|--------------|---|
| Primary port | <p>Specifies the primary port of the backup interface pair. During normal operation this port is responsible for forwarding the traffic.</p> <p>Possible values:</p> <ul style="list-style-type: none"> ▶ Physical ports |
| Backup port | <p>Specifies the backup port to which the device transfers the traffic to when the device detects an error on the primary port.</p> <p>Possible values:</p> <ul style="list-style-type: none"> ▶ Physical ports except for the port you set as the primary port. |

6 Diagnostics

The menu contains the following dialogs:

- ▶ [Status Configuration](#)
- ▶ [System](#)
- ▶ [Syslog](#)
- ▶ [Ports](#)
- ▶ [LLDP](#)
- ▶ [Report](#)

6.1 Status Configuration

The menu contains the following dialogs:

- ▶ [Device Status](#)
- ▶ [Security Status](#)
- ▶ [Signal Contact](#)
- ▶ [MAC Notification](#)
- ▶ [Alarms \(Traps\)](#)

6.1.1 Device Status

The device status provides an overview of the overall condition of the device. Many process visualization systems record the device status for a device in order to present its condition in graphic form.

The device displays its current status as `error` or `ok` in the *Device status* frame. The device determines this status from the individual monitoring results.

The device displays detected faults in the *Status* tab and also in the *Basic Settings > System* dialog, *Device Status* frame.

The dialog contains the following tabs:

- ▶ [Global]
- ▶ [Port]
- ▶ [Status]

[Global]

■ Device status

| Parameters | Meaning |
|---------------|---|
| Device status | <p>Displays the current status of the device. The device determines the status from the individual monitored parameters.</p> <p>Possible values:</p> <ul style="list-style-type: none">▶ <code>error</code> The device displays this value to indicate a detected error in one of the monitored parameters.▶ <code>ok</code> |

■ Traps

| Parameters | Meaning |
|------------|---|
| Send trap | <p>Activates/deactivates the sending of SNMP traps when the device detects changes in the monitored functions.</p> <p>Possible values:</p> <ul style="list-style-type: none">▶ <code>marked</code> The sending of SNMP traps is active. The device sends an SNMP trap when the device detects a change in the monitored functions..▶ <code>unmarked</code> (default setting) The sending of SNMP traps is inactive. <p>The prerequisite for sending SNMP traps is that you enable the function in the <i>Diagnostics > Status Configuration > Alarms (Traps)</i> dialog and specify at least 1 trap destination.</p> |

■ Table

| Parameters | Meaning |
|-----------------|---|
| Temperature | <p>Activates/deactivates the monitoring of the temperature in the device.</p> <p>Possible values:</p> <ul style="list-style-type: none">▶ <code>marked</code> (default setting) Monitoring is active. In the <i>Device status</i> frame, the value changes to <code>error</code> if the temperature exceeds or falls below the specified limit.▶ <code>unmarked</code> Monitoring is inactive. <p>You specify the temperature thresholds in the <i>Basic Settings > System</i> dialog, <i>Upper temp. limit [°C]</i> field and <i>Lower temp. limit [°C]</i> field.</p> |
| Ring redundancy | <p>Activates/deactivates the monitoring of the ring redundancy.</p> <p>Possible values:</p> <ul style="list-style-type: none">▶ <code>marked</code> Monitoring is active. In the <i>Device status</i> frame, the value changes to <code>error</code> in the following situations:<ul style="list-style-type: none">– The redundancy function becomes active (loss of redundancy reserve).– The device is a normal ring participant and detects an error in its settings.▶ <code>unmarked</code> (default setting) Monitoring is inactive. |

| Parameters | Meaning |
|-----------------------------|---|
| Connection errors | <p>Activates/deactivates the monitoring of the port/interface link.</p> <p>Possible values:</p> <ul style="list-style-type: none"> ▶ <code>marked</code> Monitoring is active. In the <i>Device status</i> frame, the value changes to <code>error</code> if the link interrupts on a monitored port/interface. In the <i>Port</i> tab, you have the option of selecting the ports/interfaces to be monitored individually. ▶ <code>unmarked</code> (default setting) Monitoring is inactive. |
| External memory removal | <p>Activates/deactivates the monitoring of the active external memory.</p> <p>Possible values:</p> <ul style="list-style-type: none"> ▶ <code>marked</code> Monitoring is active. In the <i>Device status</i> frame, the value changes to <code>error</code> if you remove the active external memory from the device. ▶ <code>unmarked</code> (default setting) Monitoring is inactive. |
| External memory not in sync | <p>Activates/deactivates the monitoring of the configuration profile in the device and in the external memory.</p> <p>Possible values:</p> <ul style="list-style-type: none"> ▶ <code>marked</code> Monitoring is active. In the <i>Device status</i> frame, the value changes to <code>error</code> in the following situations: <ul style="list-style-type: none"> – The configuration profile solely exists in the device. – The configuration profile in the device differs from the configuration profile in the external memory. ▶ <code>unmarked</code> (default setting) Monitoring is inactive. |
| Power supply | <p>Activates/deactivates the monitoring of the power supply unit.</p> <p>Possible values:</p> <ul style="list-style-type: none"> ▶ <code>marked</code> (default setting) Monitoring is active. In the <i>Device status</i> frame, the value changes to <code>error</code> if the device has a detected power supply fault. ▶ <code>unmarked</code> Monitoring is inactive. |

■ Buttons

You find the description of the standard buttons in section [“Buttons” on page 18](#).

[Port]

■ Table

| Parameters | Meaning |
|----------------------------|---|
| Propagate connection error | <p>Activates/deactivates the monitoring of the link on the port/interface.</p> <p>Possible values:</p> <ul style="list-style-type: none">▶ <code>marked</code> Monitoring is active. In the <i>Device status</i> frame, the value changes to <code>error</code> if the link on the selected port/interface is interrupted.▶ <code>unmarked</code> (default setting) Monitoring is inactive. <p>This setting takes effect when you mark the <i>Connection errors</i> checkbox in the <i>Global</i> tab.</p> |

■ Buttons

You find the description of the standard buttons in section [“Buttons” on page 18](#).

[Status]

■ Table

| Parameters | Meaning |
|------------|--|
| Timestamp | Displays the date and time of the event in the format, <code>Month Day, Year hh:mm:ss AM/PM</code> . |
| Cause | Displays the event which caused the SNMP trap. |

■ Buttons

You find the description of the standard buttons in section [“Buttons” on page 18](#).

6.1.2 Security Status

This dialog gives you an overview of the status of the safety-relevant settings in the device.

The device displays its current status as `error` or `ok` in the *Security status* frame. The device determines this status from the individual monitoring results.

The device displays detected faults in the *Status* tab and also in the *Basic Settings > System* dialog, *Security status* frame.

The dialog contains the following tabs:

- ▶ [\[Global\]](#)
- ▶ [\[Port\]](#)
- ▶ [\[Status\]](#)

[Global]

■ Security status

| Parameters | Meaning |
|-----------------|--|
| Security status | <p>Displays the current status of the security-relevant settings in the device. The device determines the status from the individual monitored parameters.</p> <p>Possible values:</p> <ul style="list-style-type: none"> ▶ <code>error</code> The device displays this value to indicate a detected error in one of the monitored parameters. ▶ <code>ok</code> |

■ Traps

| Parameters | Meaning |
|------------|--|
| Send trap | <p>Activates/deactivates the sending of SNMP traps when the device detects changes in the monitored functions.</p> <p>Possible values:</p> <ul style="list-style-type: none"> ▶ <code>marked</code> The sending of SNMP traps is active. The device sends an SNMP trap when the device detects a change in the monitored functions.. ▶ <code>unmarked</code> (default setting) The sending of SNMP traps is inactive. <p>The prerequisite for sending SNMP traps is that you enable the function in the <i>Diagnostics > Status Configuration > Alarms (Traps)</i> dialog and specify at least 1 trap destination.</p> |

■ Table

| Parameters | Meaning |
|-------------------------------------|---|
| Password default settings unchanged | <p>Activates/deactivates the monitoring of the password for the locally set up user accounts <code>user</code> and <code>admin</code>.</p> <p>Possible values:</p> <ul style="list-style-type: none"> ▶ <code>marked</code> (default setting) Monitoring is active. In the <i>Security status</i> frame, the value changes to <code>error</code> if the password for the <code>user</code> or <code>admin</code> user accounts is the default setting. ▶ <code>unmarked</code> Monitoring is inactive. <p>You set the password in the <i>Device Security > User Management</i> dialog.</p> |
| Min. password length < 8 | <p>Activates/deactivates the monitoring of the <i>Min. password length</i> policy.</p> <p>Possible values:</p> <ul style="list-style-type: none"> ▶ <code>marked</code> (default setting) Monitoring is active. In the <i>Security status</i> frame, the value changes to <code>error</code> if the value for the <i>Min. password length</i> policy is less than 8. ▶ <code>unmarked</code> Monitoring is inactive. <p>You specify the <i>Min. password length</i> policy in the <i>Device Security > User Management</i> dialog in the <i>Configuration</i> frame.</p> |

| Parameters | Meaning |
|--|---|
| Password policy settings deactivated | <p>Activates/deactivates the monitoring of the Password policies settings.</p> <p>Possible values:</p> <ul style="list-style-type: none"> ▶ marked (default setting) Monitoring is active. In the <i>Security status</i> frame, the value changes to <code>error</code> if the value for at least one of the following policies is less than 1: <ul style="list-style-type: none"> – <i>Upper-case characters (min.)</i> – <i>Lower-case characters (min.)</i> – <i>Digits (min.)</i> – <i>Special characters (min.)</i> ▶ unmarked Monitoring is inactive. <p>You specify the policy settings in the <i>Device Security > User Management</i> dialog in the <i>Password policy</i> frame.</p> |
| User account password policy check deactivated | <p>Activates/deactivates the monitoring of the <i>Policy check</i> function.</p> <p>Possible values:</p> <ul style="list-style-type: none"> ▶ marked Monitoring is active. In the <i>Security status</i> frame, the value changes to <code>error</code> if for at least 1 user account the <i>Policy check</i> function is inactive. ▶ unmarked (default setting) Monitoring is inactive. <p>You activate the <i>Policy check</i> function in the <i>Device Security > User Management</i> dialog.</p> |
| Telnet server active | <p>Activates/deactivates the monitoring of the Telnet server.</p> <p>Possible values:</p> <ul style="list-style-type: none"> ▶ marked (default setting) Monitoring is active. In the <i>Security status</i> frame, the value changes to <code>error</code> if you enable the Telnet server. ▶ unmarked Monitoring is inactive. <p>You enable/disable the Telnet server in the <i>Device Security > Management Access > Server</i> dialog, <i>Telnet</i> tab.</p> |
| HTTP server active | <p>Activates/deactivates the monitoring of the HTTP server.</p> <p>Possible values:</p> <ul style="list-style-type: none"> ▶ marked (default setting) Monitoring is active. In the <i>Security status</i> frame, the value changes to <code>error</code> if you enable the HTTP server. ▶ unmarked Monitoring is inactive. <p>You enable/disable the HTTP server in the <i>Device Security > Management Access > Server</i> dialog, <i>HTTP</i> tab.</p> |
| SNMP unencrypted | <p>Activates/deactivates the monitoring of the SNMP server.</p> <p>Possible values:</p> <ul style="list-style-type: none"> ▶ marked (default setting) Monitoring is active. In the <i>Security status</i> frame, the value changes to <code>error</code> if at least one of the following conditions applies: <ul style="list-style-type: none"> – The <i>SNMPv1</i> function is enabled. – The <i>SNMPv2</i> function is enabled. – The encryption for SNMPv3 is disabled. You enable the encryption in the <i>Device Security > User Management</i> dialog, in the <i>SNMP encryption type</i> column. ▶ unmarked Monitoring is inactive. <p>You specify the settings for the SNMP agent in the <i>Device Security > Management Access > Server</i> dialog, <i>SNMP</i> tab.</p> |

| Parameters | Meaning |
|--|---|
| Access to system monitor with V.24 possible | <p>Activates/deactivates the monitoring of the system monitor. When the system monitor is activated, the user has the possibility to change to the system monitor via a V.24 connection.</p> <p>Possible values:</p> <ul style="list-style-type: none"> ▶ <code>marked</code> Monitoring is active. In the <i>Security status</i> frame, the value changes to <code>error</code> if you activate the system monitor. ▶ <code>unmarked</code> (default setting) Monitoring is inactive. <p>You activate/deactivate the system monitor in the <i>Diagnostics > System > Selftest</i> dialog.</p> |
| Saving the configuration profile on the external memory possible | <p>Activates/deactivates the monitoring of the configuration profile in the external memory.</p> <p>Possible values:</p> <ul style="list-style-type: none"> ▶ <code>marked</code> Monitoring is active. In the <i>Security status</i> frame, the value changes to <code>error</code> if you activate the saving of the configuration profile in the external memory. ▶ <code>unmarked</code> (default setting) Monitoring is inactive. <p>You activate/deactivate the saving of the configuration profile in the external memory in the <i>Basic Settings > External Memory</i> dialog.</p> |
| Load unencrypted config from external memory | <p>Activates/deactivates the monitoring of loading unencrypted configuration profiles from the external memory.</p> <p>Possible values:</p> <ul style="list-style-type: none"> ▶ <code>marked</code> (default setting) Monitoring is active. In the <i>Security status</i> frame, the value changes to <code>error</code> when the settings allow the device to load an unencrypted configuration profile from the external memory. The <i>Security status</i> frame in the <i>Basic Settings > System</i> dialog, displays an alarm if the following preconditions are fulfilled: <ul style="list-style-type: none"> – The configuration profile stored in the external memory is unencrypted. and – The <i>Config priority</i> column in the <i>Basic Settings > External Memory</i> dialog has the value <code>first</code>. ▶ <code>unmarked</code> Monitoring is inactive. |
| Link interrupted on enabled device ports | <p>Activates/deactivates the monitoring of the link on the active ports.</p> <p>Possible values:</p> <ul style="list-style-type: none"> ▶ <code>marked</code> Monitoring is active. In the <i>Security status</i> frame, the value changes to <code>error</code> if the link interrupts on an active port. In the <i>Port</i> tab, you have the option of selecting the ports to be monitored individually. ▶ <code>unmarked</code> (default setting) Monitoring is inactive. |
| Access with HiDiscovery possible | <p>Activates/deactivates the monitoring of the HiDiscovery function.</p> <p>Possible values:</p> <ul style="list-style-type: none"> ▶ <code>marked</code> (default setting) Monitoring is active. In the <i>Security status</i> frame, the value changes to <code>error</code> if you enable the HiDiscovery function. ▶ <code>unmarked</code> Monitoring is inactive. <p>You enable/disable the HiDiscovery function in the <i>Basic Settings > Network</i> dialog.</p> |

| Parameters | Meaning |
|---------------------------------------|--|
| IEC61850-MMS active | <p>Activates/deactivates the monitoring of the <i>IEC61850-MMS</i> function.</p> <p>Possible values:</p> <ul style="list-style-type: none"> ▶ <i>marked</i> (default setting) Monitoring is active. In the <i>Security status</i> frame, the value changes to <i>error</i> if you enable the <i>IEC61850-MMS</i> function. ▶ <i>unmarked</i> Monitoring is inactive. <p>You enable/disable the <i>IEC61850-MMS</i> function in the <i>Industrial Protocols > IEC61850-MMS</i> dialog, <i>Operation</i> frame.</p> |
| Modbus TCP active | <p>Activates/deactivates the monitoring of the <i>Modbus TCP</i> function.</p> <p>Possible values:</p> <ul style="list-style-type: none"> ▶ <i>marked</i> (default setting) Monitoring is active. In the <i>Security status</i> frame, the value changes to <i>error</i> if you enable the <i>Modbus TCP</i> function. ▶ <i>unmarked</i> Monitoring is inactive. <p>You enable/disable the <i>Modbus TCP</i> function in the <i>Advanced > Industrial Protocols > Modbus TCP</i> dialog, <i>Operation</i> frame.</p> |
| EtherNet/IP active | <p>Activates/deactivates the monitoring of the <i>EtherNet/IP</i> function.</p> <p>Possible values:</p> <ul style="list-style-type: none"> ▶ <i>marked</i> (default setting) Monitoring is active. In the <i>Security status</i> frame, the value changes to <i>error</i> if you enable the <i>EtherNet/IP</i> function. ▶ <i>unmarked</i> Monitoring is inactive. <p>You enable/disable the <i>EtherNet/IP</i> function in the <i>Advanced > Industrial Protocols > EtherNet/IP</i> dialog, <i>Operation</i> frame.</p> |
| PROFINET active | <p>Activates/deactivates the monitoring of the <i>PROFINET</i> function.</p> <p>Possible values:</p> <ul style="list-style-type: none"> ▶ <i>marked</i> (default setting) Monitoring is active. In the <i>Security status</i> frame, the value changes to <i>error</i> if you enable the <i>PROFINET</i> function. ▶ <i>unmarked</i> Monitoring is inactive. <p>You enable/disable the <i>PROFINET</i> function in the <i>Advanced > Industrial Protocols > PROFINET</i> dialog, <i>Operation</i> frame.</p> |
| Self-signed HTTPS certificate present | <p>Activates/deactivates the monitoring of the HTTPS certificate.</p> <p>Possible values:</p> <ul style="list-style-type: none"> ▶ <i>marked</i> (default setting) Monitoring is active. In the <i>Security status</i> frame, the value changes to <i>error</i> if the HTTPS server uses a self-created digital certificate. ▶ <i>unmarked</i> Monitoring is inactive. |

■ Buttons

You find the description of the standard buttons in section [“Buttons” on page 18](#).

[Port]

■ Table

| Parameters | Meaning |
|--|--|
| Link interrupted on enabled device ports | <p>Activates/deactivates the monitoring of the link on the active ports.</p> <p>Possible values:</p> <ul style="list-style-type: none"> ▶ <code>marked</code> Monitoring is active. In the <i>Security status</i> frame, the value changes to <code>error</code> when the port is enabled (<i>Basic Settings > Port</i> dialog, <i>Configuration</i> tab, <i>Port on</i> checkbox is <code>marked</code>) and the link is down on the port. ▶ <code>unmarked</code> (default setting) Monitoring is inactive. <p>This setting takes effect when you mark the <i>Link interrupted on enabled device ports</i> checkbox in the <i>Diagnostics > Status Configuration > Security Status</i> dialog, <i>Global</i> tab.</p> |

■ Buttons

You find the description of the standard buttons in section [“Buttons” on page 18](#).

[Status]

■ Table

| Parameters | Meaning |
|------------|--|
| Timestamp | Displays the date and time of the event in the format, Month Day, Year hh:mm:ss AM/PM. |
| Cause | Displays the event which caused the SNMP trap. |

■ Buttons

You find the description of the standard buttons in section [“Buttons” on page 18](#).

6.1.3 Signal Contact

The signal contact is a potential-free relay contact. The device thus allows you to perform remote diagnosis. The device uses the relay contact to signal the occurrence of events by opening the relay contact and interrupting the closed circuit.

Note: The device can contain several signal contacts. Each contact contains the same monitoring functions. Several contacts allow you to group various functions together providing flexibility in system monitoring.

The menu contains the following dialogs:

▶ [Signal Contact 1 / Signal Contact 2](#)

6.1.3.1 Signal Contact 1 / Signal Contact 2

In this dialog you specify the trigger conditions for the signal contact.

The signal contact gives you the following options:

- ▶ Monitoring the correct operation of the device.
- ▶ Signaling the device status of the device.
- ▶ Signaling the security status of the device.
- ▶ Controlling external devices by manually setting the signal contacts.

The device displays detected faults in the *Status* tab and also in the *Basic Settings > System* dialog, *Signal contact status* frame.

The dialog contains the following tabs:

- ▶ [Global]
- ▶ [Port]
- ▶ [Status]

[Global]

■ Configuration

| Parameters | Meaning |
|------------|---|
| Mode | <p>Specifies which events the signal contact indicates.</p> <p>Possible values:</p> <ul style="list-style-type: none"> ▶ <i>Manual setting</i> (default setting for <i>Signal Contact 2</i>, if present) You use this setting to manually open or close the signal contact, for example to turn on or off a remote device. See the <i>Contact</i> option list. ▶ <i>Monitoring correct operation</i> (default setting) Using this setting the signal contact indicates the status of the parameters specified in the table below. ▶ <i>Device status</i> Using this setting the signal contact indicates the status of the parameters monitored in the <i>Diagnostics > Status Configuration > Device Status</i> dialog. In addition, you can read the status in the <i>Signal contact status</i> frame. ▶ <i>Security status</i> Using this setting the signal contact indicates the status of the parameters monitored in the <i>Diagnostics > Status Configuration > Security Status</i> dialog. In addition, you can read the status in the <i>Signal contact status</i> frame. ▶ <i>Device/Security status</i> Using this setting the signal contact indicates the status of the parameters monitored in the <i>Diagnostics > Status Configuration > Device Status</i> and the <i>Diagnostics > Status Configuration > Security Status</i> dialog. In addition, you can read the status in the <i>Signal contact status</i> frame. |
| Contact | <p>Toggles the signal contact manually. The prerequisite is that you select in the <i>Mode</i> drop-down list the value <i>Manual setting</i>.</p> <p>Possible values:</p> <ul style="list-style-type: none"> ▶ <i>open</i> The signal contact is opened. ▶ <i>close</i> The signal contact is closed. |

■ Signal contact status

| Parameters | Meaning |
|-----------------------|--|
| Signal contact status | <p>Displays the current status of the signal contact.</p> <p>Possible values:</p> <ul style="list-style-type: none"> ▶ <i>Opened (error)</i> The signal contact is opened. The circuit is interrupted. ▶ <i>Closed (ok)</i> The signal contact is closed. The circuit is closed. |

■ Trap configuration

| Parameters | Meaning |
|------------|--|
| Send trap | <p>Activates/deactivates the sending of SNMP traps when the device detects changes in the monitored functions.</p> <p>Possible values:</p> <ul style="list-style-type: none"> ▶ <code>marked</code> The sending of SNMP traps is active. The device sends an SNMP trap when the device detects a change in the monitored functions.. ▶ <code>unmarked</code> (default setting) The sending of SNMP traps is inactive. <p>The prerequisite for sending SNMP traps is that you enable the function in the <i>Diagnostics > Status Configuration > Alarms (Traps)</i> dialog and specify at least 1 trap destination.</p> |

■ Monitoring correct operation

In the table you specify the parameters that the device monitors. The device signals the occurrence of an event by opening the signal contact.

| Parameters | Meaning |
|-------------------------|--|
| Temperature | <p>Activates/deactivates the monitoring of the temperature in the device.</p> <p>Possible values:</p> <ul style="list-style-type: none"> ▶ <code>marked</code> (default setting) Monitoring is active. The signal contact opens if the temperature exceeds / falls below the threshold values. ▶ <code>unmarked</code> Monitoring is inactive. <p>You specify the temperature thresholds in the <i>Basic Settings > System</i> dialog, <i>Upper temp. limit [°C]</i> field and <i>Lower temp. limit [°C]</i> field.</p> |
| Ring redundancy | <p>Activates/deactivates the monitoring of the ring redundancy.</p> <p>Possible values:</p> <ul style="list-style-type: none"> ▶ <code>marked</code> Monitoring is active. The signal contact opens in the following situations: <ul style="list-style-type: none"> – The redundancy function becomes active (loss of redundancy reserve). – The device is a normal ring participant and detects an error in its settings. ▶ <code>unmarked</code> (default setting) Monitoring is inactive. |
| Connection errors | <p>Activates/deactivates the monitoring of the port/interface link.</p> <p>Possible values:</p> <ul style="list-style-type: none"> ▶ <code>marked</code> Monitoring is active. The signal contact opens if the link interrupts on a monitored port/interface. In the <i>Port</i> tab, you have the option of selecting the ports/interfaces to be monitored individually. ▶ <code>unmarked</code> (default setting) Monitoring is inactive. |
| External memory removed | <p>Activates/deactivates the monitoring of the active external memory.</p> <p>Possible values:</p> <ul style="list-style-type: none"> ▶ <code>marked</code> Monitoring is active. The signal contact opens if you remove the active external memory from the device. ▶ <code>unmarked</code> (default setting) Monitoring is inactive. |

| Parameters | Meaning |
|--------------------------------------|---|
| External memory not in sync with NVM | <p>Activates/deactivates the monitoring of the configuration profile in the device and in the external memory.</p> <p>Possible values:</p> <ul style="list-style-type: none"> ▶ <code>marked</code> Monitoring is active. The signal contact opens in the following situations: <ul style="list-style-type: none"> – The configuration profile solely exists in the device. – The configuration profile in the device differs from the configuration profile in the external memory. ▶ <code>unmarked</code> (default setting) Monitoring is inactive. |
| Power supply | <p>Activates/deactivates the monitoring of the power supply unit.</p> <p>Possible values:</p> <ul style="list-style-type: none"> ▶ <code>marked</code> (default setting) Monitoring is active. The signal contact opens if the device has a detected power supply fault. ▶ <code>unmarked</code> Monitoring is inactive. |

■ Buttons

You find the description of the standard buttons in section [“Buttons” on page 18](#).

[Port]

■ Table

| Parameters | Meaning |
|----------------------------|--|
| Propagate connection error | Activates/deactivates the monitoring of the link on the port/interface. Possible values: <ul style="list-style-type: none">▶ <code>marked</code> Monitoring is active. The signal contact opens if the link interrupts on the selected port/interface.▶ <code>unmarked</code> (default setting) Monitoring is inactive. <p>This setting takes effect when you mark the <i>Connection errors</i> checkbox in the <i>Global</i> tab.</p> |

■ Buttons

You find the description of the standard buttons in section [“Buttons” on page 18](#).

[Status]

■ Table

| Parameters | Meaning |
|------------|--|
| Timestamp | Displays the date and time of the event in the format, <i>Month Day, Year hh:mm:ss AM/PM</i> . |
| Cause | Displays the event which caused the SNMP trap. |

■ Buttons

You find the description of the standard buttons in section [“Buttons” on page 18](#).

6.1.4 MAC Notification

The device allows you to track changes in the network using the MAC address of the devices in the network. The device saves the combination of port and MAC address in its MAC address table. When the device (un)learns the MAC address of a (dis)connected device, the device sends an SNMP trap.

This function is intended for ports to which you connect end devices and thus the MAC address changes infrequently.

■ Operation

| Parameters | Meaning |
|------------|--|
| Operation | Enables/disables the <i>MAC Notification</i> function on the device. Possible values: <ul style="list-style-type: none">▶ On The <i>MAC Notification</i> function is enabled.▶ Off (default setting) The <i>MAC Notification</i> function is disabled. |

■ Configuration

| Parameters | Meaning |
|--------------|--|
| Interval [s] | Specifies the send interval in seconds. When the device (un)learns the MAC address of a (dis)connected device, it sends an SNMP trap after this time. Possible values: <ul style="list-style-type: none">▶ 0..2147483647 (default setting: 30) Before sending an SNMP trap, the device registers up to 20 MAC addresses. If the device detects a high number of changes, it sends the SNMP trap before the send interval expires. |

■ Table

| Parameters | Meaning |
|------------------|---|
| Port | Displays the port number. |
| Active | Activates/deactivates the <i>MAC Notification</i> function on the port. Possible values: <ul style="list-style-type: none">▶ marked The <i>MAC Notification</i> function is active on the port. The device sends an SNMP trap in case of one of the following events:<ul style="list-style-type: none">– The device learns the MAC address of a newly connected device.– The device unlearns the MAC address of a disconnected device.▶ unmarked (default setting) The <i>MAC Notification</i> function is inactive on the port. The prerequisite for sending SNMP traps is that you enable the function in the <i>Diagnostics > Status Configuration > Alarms (Traps)</i> dialog and specify at least 1 trap destination. |
| Last MAC address | Displays the MAC address of the device last connected on or disconnected from the port. The device detects the MAC addresses of devices which are connected as follows: <ul style="list-style-type: none">– directly connected to the port– connected to the port through other devices in the network |

| Parameters | Meaning |
|-----------------|--|
| Last MAC status | Displays the status of the <i>Last MAC address</i> value on this port. Possible values: <ul style="list-style-type: none">▶ added The device detected that another device was connected at the port.▶ removed The device detected that the connected device was removed from the port.▶ other The device did not detect a status. |

■ Buttons

You find the description of the standard buttons in section [“Buttons” on page 18](#).

6.1.5 Alarms (Traps)

The device offers you the option of sending an SNMP trap as a reaction to specific events. In this dialog, you specify the trap destinations to which the device sends the SNMP traps.

The events for which the device triggers an SNMP trap, you specify, for example, in the following dialogs:

- ▶ in the *Diagnostics > Status Configuration > Device Status* dialog
- ▶ in the *Diagnostics > Status Configuration > Security Status* dialog
- ▶ in the *Diagnostics > Status Configuration > MAC Notification* dialog

■ Operation

| Parameters | Meaning |
|------------|--|
| Operation | Enables/disables the sending of SNMP traps to the trap destinations. Possible values: <ul style="list-style-type: none">▶ On (default setting) The sending of SNMP traps is enabled.▶ Off The sending of SNMP traps is disabled. |

■ Table

| Parameters | Meaning |
|------------|---|
| Name | Specifies the name of the trap destination. Possible values: <ul style="list-style-type: none">▶ Alphanumeric ASCII character string with 1..32 characters |
| Address | Specifies the IP address and the port number of the trap destination. Possible values: <ul style="list-style-type: none">▶ <Valid IPv4 address>:<port number> |
| Active | Activates/deactivates the sending of SNMP traps to this trap destination. Possible values: <ul style="list-style-type: none">▶ marked (default setting) The sending of SNMP traps to this trap destination is active.▶ unmarked The sending of SNMP traps to this trap destination is inactive. |

■ Buttons

You find the description of the standard buttons in section [“Buttons” on page 18](#).

| Button | Meaning |
|---|--|
|  | Opens the <i>Create</i> window to add a new entry to the table. <ul style="list-style-type: none">▶ In the <i>Name</i> field you specify a name for the trap destination.▶ In the <i>Address</i> field you specify the IP address and the port number of the trap destination. If you choose not to enter a port number, the device automatically adds the port number 162. |

6.2 System

The menu contains the following dialogs:

- ▶ [System Information](#)
- ▶ [Hardware State](#)
- ▶ [Configuration Check](#)
- ▶ [IP Address Conflict Detection](#)
- ▶ [ARP](#)
- ▶ [Selftest](#)

6.2.1 System Information

This dialog displays the current operating condition of individual components in the device. The displayed values are a snapshot; they represent the operating condition at the time the dialog was loaded to the page.

■ Buttons

You find the description of the standard buttons in section [“Buttons” on page 18](#).

| Button | Meaning |
|---|--|
|  | Displays a sub menu with the following items. |
| Save system information | Opens the HTML page in a new web browser window or tab. You can save the HTML page on your PC using the appropriate web browser command. |

6.2.2 Hardware State

This dialog provides information about the distribution and state of the flash memory of the device.

■ Information

| Parameters | Meaning |
|------------|--|
| Uptime | Displays the total operating time of the device since it was delivered. Possible values: ▶ ..d ..h ..m ..s Day(s) Hour(s) Minute(s) Second(s) |

■ Table

| Parameters | Meaning |
|-------------------------|--|
| Flash region | Displays the name of the respective memory area. |
| Description | Displays a description of what the device uses the memory area for. |
| Flash sectors | Displays how many sectors are assigned to the memory area. |
| Sector erase operations | Displays how many times the device has overwritten the sectors of the memory area. |

■ Buttons

You find the description of the standard buttons in section [“Buttons” on page 18](#).

6.2.3 Configuration Check

The device allows you to compare the settings in the device with the settings in its neighboring devices. For this purpose, the device uses the information that it received from its neighboring devices through topology recognition (LLDP).

The dialog lists the deviations detected, which affect the performance of the communication between the device and the recognized neighboring devices.

You update the content of the table by clicking the  button. If the table remains empty, the configuration check was successful and the settings in device are compatible with the settings in the detected neighboring devices.

■ Summary

You also find this information, when you position the mouse pointer over the  button in the Toolbar in the top part of the Navigation area.

| Parameters | Meaning |
|-------------|---|
| Error | Displays the number of errors that the device detected during the configuration check. |
| Warning | Displays the number of warnings that the device detected during the configuration check. |
| Information | Displays the amount of information that the device detected during the configuration check. |

■ Table

When you highlight a row in the table, the device displays additional information in the area beneath it.

| Parameters | Meaning |
|------------|---|
| ID | Displays the rule ID of the deviations having occurred. The dialog combines several deviations with the same rule ID under one rule ID. |
| Level | Displays the level of deviation between the settings in this device and the settings in the detected neighboring devices. The device differentiates between the following access statuses: <ul style="list-style-type: none">▶ INFORMATION The performance of the communication between the two devices is not impaired.▶ WARNING The performance of the communication between the two devices is possibly impaired.▶ ERROR The communication between the two devices is impaired. |
| Message | Displays the information, warnings and errors having occurred more precisely. |

Note: A neighboring device without LLDP support, which forwards LLDP packets, may be the cause of equivocal messages in the dialog. This occurs if the neighboring device is a hub or a switch without management, which ignores the IEEE 802.1D-2004 standard.

In this case, the dialog displays the devices recognized and connected to the neighboring device as connected to the device itself, even though they are connected to the neighboring device.

Note: If you have set up more than 39 VLANs on the device, then the dialog always displays a warning. The reason is the limited number of possible VLAN data sets in LLDP packets with a maximum length. The device compares the first 39 VLANs automatically. If you have set up 40 or more VLANs on the device, then check the congruence of the further VLANs manually, if necessary.

■ Buttons

You find the description of the standard buttons in section [“Buttons” on page 18](#).

6.2.4 IP Address Conflict Detection

Using the *IP Address Conflict Detection* function the device verifies that its IP address is unique in the network. For this purpose, the device analyzes received ARP packets.

In this dialog you specify the procedure with which the device detects address conflicts and specify the required settings for this.

The device displays detected address conflicts in the table.

Whenever the device detects an address conflict, the status LED of the device flashes red 4 times.

■ Operation

| Parameters | Meaning |
|------------|---|
| Operation | Enables/disables the <i>IP Address Conflict Detection</i> function. Possible values: <ul style="list-style-type: none">▶ On (default setting) The <i>IP Address Conflict Detection</i> function is enabled. The device verifies that its IP address is unique in the network.▶ Off The <i>IP Address Conflict Detection</i> function is disabled. |

■ Configuration

| Parameters | Meaning |
|--------------------------|--|
| Detection mode | <p>Specifies the procedure with which the device detects address conflicts.</p> <p>Possible values:</p> <ul style="list-style-type: none"> ▶ <code>active and passive</code> (default setting) The device uses active and passive address conflict detection. ▶ <code>active</code> Active address conflict detection. The device actively avoids communicating with an IP address that already exists in the network. The address conflict detection begins as soon as you connect the device to the network or change its IP parameters. <ul style="list-style-type: none"> – The device sends 4 ARP probe data packets at the interval specified in the <i>Detection delay [ms]</i> field. If the device receives a response to these data packets, there is an address conflict. – If the device does not detect an address conflict, it sends 2 gratuitous ARP data packets as an announcement. The device also sends these data packets when the address conflict detection is disabled. – If the IP address already exists in the network, the device changes back to the previously used IP parameters (if possible). If the device receives its IP parameters from a DHCP server, it sends a DHCPDECLINE message back to the DHCP server. – After the period specified in the <i>Release delay [s]</i> field, the device checks whether the address conflict still exists. If the device detects 10 address conflicts one after the other, it extends the waiting time to 60 s for the next check. – When the address conflict has been resolved, the device management returns to the network again. ▶ <code>passive</code> Passive address conflict detection. The device analyzes the data traffic in the network. If another device in the network is using the same IP address, the device initially “defends” its IP address. The device stops sending if the other device keeps sending with the same IP address. <ul style="list-style-type: none"> – As a “defence” the device sends gratuitous ARP data packets. The device repeats this procedure for the number of times specified in the <i>Address protections</i> field. – If the other device continues sending with the same IP address, after the period specified in the <i>Release delay [s]</i> field, the device periodically checks whether the address conflict still exists. – When the address conflict has been resolved, the device management returns to the network again. |
| Send periodic ARP probes | <p>Activates/deactivates the periodic address conflict detection.</p> <p>Possible values:</p> <ul style="list-style-type: none"> ▶ <code>marked</code> (default setting) The periodic address conflict detection is active. <ul style="list-style-type: none"> – The device periodically sends an ARP probe data packet every 90 to 150 seconds and waits for the time specified in the <i>Detection delay [ms]</i> field for a response. – If the device detects an address conflict, it applies the passive detection mode function. If the <i>Send trap</i> function is active, the device sends an SNMP trap. ▶ <code>unmarked</code> The periodic address conflict detection is inactive. |
| Detection delay [ms] | <p>Specifies the period in milliseconds for which the device waits for a response after sending a ARP data packets.</p> <p>Possible values:</p> <ul style="list-style-type: none"> ▶ <code>20..500</code> (default setting: 200) |
| Release delay [s] | <p>Specifies the period in seconds after which the device checks again whether the address conflict still exists.</p> <p>Possible values:</p> <ul style="list-style-type: none"> ▶ <code>3..3600</code> (default setting: 15) |
| Address protections | <p>Specifies how many times the device sends gratuitous ARP data packets in the passive detection mode to “defend” its IP address.</p> <p>Possible values:</p> <ul style="list-style-type: none"> ▶ <code>0..100</code> (default setting: 3) |

| Parameters | Meaning |
|--------------------------|--|
| Protection interval [ms] | Specifies the period in milliseconds after which the device sends gratuitous ARP data packets again in the passive detection mode to “defend” its IP address. Possible values: ▶ 20..5000 (default setting: 200) |
| Send trap | Activates/deactivates the sending of SNMP traps when the device detects address conflicts. Possible values: ▶ marked The sending of SNMP traps is active. The device sends an SNMP trap when it detects an address conflict. ▶ unmarked (default setting) The sending of SNMP traps is inactive. The prerequisite for sending SNMP traps is that you enable the function in the <i>Diagnostics</i> > Status Configuration > <i>Alarms (Traps)</i> dialog and specify at least 1 trap destination. |

■ Information

| Parameters | Meaning |
|-------------------|--|
| Conflict detected | Displays whether an address conflict currently exists. Possible values: ▶ marked The device detects an address conflict. ▶ unmarked The device does not detect an address conflict. |

■ Table

| Parameters | Meaning |
|-------------|--|
| Timestamp | Displays the time at which the device detected an address conflict. |
| Port | Displays the number of the port on which the device detected the address conflict. |
| IP address | Displays the IP address that is causing the address conflict. |
| MAC address | Displays the MAC address of the device with which the address conflict exists. |

■ Buttons

You find the description of the standard buttons in section [“Buttons” on page 18](#).

6.2.5 ARP

This dialog displays the MAC and IP addresses of the neighboring devices connected to the device management.

■ Table

| Parameters | Meaning |
|--------------|--|
| Port | Displays the port number. |
| IP address | Displays the IP address of a device that responded to an ARP query to this port. |
| MAC address | Displays the MAC address of a device that responded to an ARP query to this port. |
| Last updated | Displays the time in seconds since the current settings of the entry were registered in the ARP table. |
| Type | Displays the type of the ARP entry. Possible values: <ul style="list-style-type: none">▶ <code>static</code> Static ARP entry. The ARP entry is kept when the ARP table is deleted.▶ <code>dynamic</code> Dynamic ARP entry. The device deletes the ARP entry when the <i>Aging time [s]</i> has been exceeded, if the device does not receive any data from this device during this time.▶ <code>local</code> IP and MAC address of the device management. |
| Active | Displays that the ARP table contains the IP/MAC address assignment as an active entry. |

■ Buttons

You find the description of the standard buttons in section [“Buttons” on page 18](#).

| Button | Meaning |
|---|--|
|  | Displays a sub menu with the following items. |
| Reset ARP table | Removes the dynamically set up addresses from the ARP table. |

6.2.6 Selftest

This dialog allows you to do the following:

- ▶ Activate/deactivate the RAM test when the device is being started.
- ▶ Enable/disable the option of entering the system monitor upon the system start.
- ▶ Specifies how the device behaves in the case of an error.

■ Configuration

| Parameters | Meaning |
|------------------------------|---|
| RAM test | <p>Activates/deactivates the RAM memory check during the restart.</p> <p>Possible values:</p> <ul style="list-style-type: none">▶ <code>marked</code> (default setting) The RAM memory check is activated. During the restart, the device checks the RAM memory.▶ <code>unmarked</code> The RAM memory check is deactivated. This shortens the start time for the device. |
| SysMon1 is available | <p>Activates/deactivates the access to the system monitor during the restart.</p> <p>Possible values:</p> <ul style="list-style-type: none">▶ <code>marked</code> (default setting) The device allows you to open the system monitor during the restart.▶ <code>unmarked</code> The device starts without the option of opening to the system monitor. <p>Among other things, the system monitor allows you to update the device software and to delete saved configuration profiles.</p> |
| Load default config on error | <p>Activates/deactivates the loading of the default settings if the device does not detect any readable configuration profile when it is restarting.</p> <p>Possible values:</p> <ul style="list-style-type: none">▶ <code>marked</code> (default setting) The device loads the default settings.▶ <code>unmarked</code> The device interrupts the restart and stops. The management access to the device is possible exclusively using the CLI through the V.24 interface. To regain the access to the device through the network, open the system monitor and reset the settings. Upon restart, the device loads the default settings. |

Note: The following settings block your access to the device permanently if the device does not detect any readable configuration profile when it is restarting. This is the case, for example, if the password of the configuration profile that you are loading differs from the password set in the device.

- ▶ *SysMon1 is available* checkbox is unmarked.
- ▶ *Load default config on error* checkbox is unmarked.

To have the device unlocked again, contact your sales partner.

■ Table

In this table you specify how the device behaves in the case of an error.

| Parameters | Meaning |
|------------|--|
| Cause | <p>Error causes to which the device reacts.</p> <p>Possible values:</p> <ul style="list-style-type: none"> ▶ <code>task</code> The device detects errors in the applications executed, for example if a task terminates or is not available. ▶ <code>resource</code> The device detects errors in the resources available, for example if the memory is becoming scarce. ▶ <code>software</code> The device detects software errors, for example error in the consistency check. ▶ <code>hardware</code> The device detects hardware errors, for example in the chip set. |
| Action | <p>Specifies how the device behaves if the adjacent event occurs.</p> <p>Possible values:</p> <ul style="list-style-type: none"> ▶ <code>reboot</code> (default setting) The device triggers a restart. ▶ <code>logOnly</code> The device registers the detected error in the log file. See the <i>Diagnostics > Report > System Log</i> dialog. ▶ <code>sendTrap</code> The device sends an SNMP trap. The prerequisite for sending SNMP traps is that you enable the function in the <i>Diagnostics > Status Configuration > Alarms (Traps)</i> dialog and specify at least 1 trap destination. |

■ Buttons

You find the description of the standard buttons in section [“Buttons” on page 18](#).

6.3 Syslog

The device allows you to report selected events, independent of the severity of the event, to different syslog servers. In this dialog, you specify the settings for this function and manage up to 8 syslog servers.

■ Operation

| Parameters | Meaning |
|------------|---|
| Operation | Enables/disables the sending of events to the syslog servers. Possible values: <ul style="list-style-type: none">▶ On The sending of events is enabled. The device sends the events specified in the table to the specified syslog servers.▶ Off (default setting) The sending of events is disabled. |

■ Table

| Parameters | Meaning |
|----------------------|--|
| Index | Displays the index number to which the table entry relates. When you delete a table entry, this leaves a gap in the numbering. When you create a new table entry, the device fills the first gap. Possible values: <ul style="list-style-type: none">▶ 1..8 |
| IP address | Specifies the IP address of the syslog server. Possible values: <ul style="list-style-type: none">▶ Valid IPv4 address (default setting: 0.0.0.0) |
| Destination UDP port | Specifies the UDP port on which the syslog server expects the log entries. Possible values: <ul style="list-style-type: none">▶ 1..65535 (default setting: 514) |
| Transport type | Displays the transport type the device uses to send the events to the syslog server. Possible values: <ul style="list-style-type: none">▶ udp The device sends the events over the UDP port specified in the <i>Destination UDP port</i> column. |
| Min. severity | Specifies the minimum severity of the events. The device sends a log entry for events with this severity and with more urgent severities to the syslog server. Possible values: <ul style="list-style-type: none">▶ emergency▶ alert▶ critical▶ error▶ warning (default setting)▶ notice▶ informational▶ debug |
| Type | Specifies the type of the log entry transmitted by the device. Possible values: <ul style="list-style-type: none">▶ systemlog (default setting)▶ audittrail |

| Parameters | Meaning |
|------------|--|
| Active | Activates/deactivates the transmission of events to the syslog server: <ul style="list-style-type: none">▶ <code>marked</code> The device sends events to the syslog server.▶ <code>unmarked</code> (default setting) The transmission of events to the syslog server is deactivated. |

■ Buttons

You find the description of the standard buttons in section [“Buttons” on page 18](#).

6.4 Ports

The menu contains the following dialogs:

- ▶ SFP
- ▶ Port Monitor
- ▶ Auto-Disable
- ▶ Port Mirroring

6.4.1 SFP

This dialog allows you to look at the SFP transceivers currently connected to the device and their properties.

■ Table

The table displays valid values if the device is equipped with SFP transceivers.

| Parameters | Meaning |
|------------------|---|
| Port | Displays the port number. |
| Module type | Type of the SFP transceiver, for example M-SFP-SX/LC. |
| Serial number | Displays the serial number of the SFP transceiver. |
| Connector type | Displays the connector type. |
| Supported | Displays whether the device supports the SFP transceiver. |
| Temperature [°C] | Operating temperature of the SFP transceiver in °Celsius. |
| Tx power [mW] | Transmission power of the SFP transceiver in mW. |
| Rx power [mW] | Receiving power of the SFP transceiver in mW. |
| Tx power [dBm] | Transmission power of the SFP transceiver in dBm. |
| Rx power [dBm] | Receiving power of the SFP transceiver in dBm. |

■ Buttons

You find the description of the standard buttons in section [“Buttons” on page 18](#).

6.4.2 Port Monitor

The *Port Monitor* function monitors the adherence to the specified parameters on the ports. If the *Port Monitor* function detects that the parameters are being exceeded, the device performs an action.

To apply the *Port Monitor* function, proceed as follows:

- ▶ *Global* tab
 - Enable the *Operation* function in the *Port Monitor* frame.
 - Activate for each port those parameters that you want the *Port Monitor* function to monitor.
- ▶ *Link flap, CRC/Fragments* and *Overload detection* tabs
 - Specify the threshold values for the parameters for each port.
- ▶ *Link speed/Duplex mode detection* tab
 - Activate the allowed combinations of speed and duplex mode for each port.
- ▶ *Global* tab
 - Specify for each port an action that the device carries out when the *Port Monitor* function detects that the parameters have been exceeded.
- ▶ *Auto-disable* tab
 - Mark the *Auto-disable* checkbox for the monitored parameters when you have specified the `auto-disable` action at least once.

The dialog contains the following tabs:

- ▶ [Global]
- ▶ [Auto-disable]
- ▶ [Link flap]
- ▶ [CRC/Fragments]
- ▶ [Overload detection]
- ▶ [Link speed/Duplex mode detection]

[Global]

In this tab, you enable the *Port Monitor* function and specify the parameters that the *Port Monitor* function is monitoring. Also specify the action that the device carries out when the *Port Monitor* function detects that the parameters have been exceeded.

■ Operation

| Parameters | Meaning |
|------------|---|
| Operation | Enables/disables the <i>Port Monitor</i> function globally. Possible values: <ul style="list-style-type: none">▶ On The <i>Port Monitor</i> function is enabled.▶ Off (default setting) The <i>Port Monitor</i> function is disabled. |

■ **Table**

| Parameters | Meaning |
|-------------------------------------|--|
| Port | Displays the port number. |
| Link flap on | <p>Activates/deactivates the monitoring of link flaps on the port.</p> <p>Possible values:</p> <ul style="list-style-type: none"> ▶ marked Monitoring is active. <ul style="list-style-type: none"> – The <i>Port Monitor</i> function monitors link flaps on the port. – If the device detects too many link flaps, the device executes the action specified in the <i>Action</i> column. – On the <i>Link flap</i> tab, specify the parameters to be monitored. ▶ unmarked (default setting) Monitoring is inactive. |
| CRC/Fragments on | <p>Activates/deactivates the monitoring of CRC/fragment errors on the port.</p> <p>Possible values:</p> <ul style="list-style-type: none"> ▶ marked Monitoring is active. <ul style="list-style-type: none"> – The <i>Port Monitor</i> function monitors CRC/fragment errors on the port. – If the device detects too many CRC/fragment errors, the device executes the action specified in the <i>Action</i> column. – On the <i>CRC/Fragments</i> tab, specify the parameters to be monitored. ▶ unmarked (default setting) Monitoring is inactive. |
| Duplex mismatch detection active | <p>Activates/deactivates the monitoring of duplex mismatches on the port.</p> <p>Possible values:</p> <ul style="list-style-type: none"> ▶ marked Monitoring is active. <ul style="list-style-type: none"> – The <i>Port Monitor</i> function monitors duplex mismatches on the port. – If the device detects a duplex mismatch, the device executes the action specified in the <i>Action</i> column. ▶ unmarked (default setting) Monitoring is inactive. |
| Overload detection on | <p>Activates/deactivates the overload detection on the port.</p> <p>Possible values:</p> <ul style="list-style-type: none"> ▶ marked Monitoring is active. <ul style="list-style-type: none"> – The <i>Port Monitor</i> function monitors the data load on the port. – If the device detects a data overload on the port, the device executes the action specified in the <i>Action</i> column. – On the <i>Overload detection</i> tab, specify the parameters to be monitored. ▶ unmarked (default setting) Monitoring is inactive. |
| Link speed/Duplex mode detection on | <p>Activates/deactivates the monitoring of the link speed and duplex mode on the port.</p> <p>Possible values:</p> <ul style="list-style-type: none"> ▶ marked Monitoring is active. <ul style="list-style-type: none"> – The <i>Port Monitor</i> function monitors the link speed and duplex mode on the port. – If the device detects an unpermitted combination of link speed and duplex mode, the device executes the action specified in the <i>Action</i> column. – On the <i>Link speed/Duplex mode detection</i> tab, specify the parameters to be monitored. ▶ unmarked (default setting) Monitoring is inactive. |

| Parameters | Meaning |
|------------------|---|
| Active condition | <p>Displays the monitored parameter that led to the action on the port.</p> <p>Possible values:</p> <ul style="list-style-type: none"> ▶ - No monitored parameter. The device does not carry out any action. ▶ Link flap Too many link changes in the observed period. ▶ CRC/Fragments Too many CRC/fragment errors in the observed period. ▶ Duplex mismatch Duplex mismatch detected. ▶ Overload detection Overload detected in the observed period. ▶ Link speed/Duplex mode detection Impermissible combination of speed and duplex mode detected. |
| Action | <p>Specifies the action that the device carries out when the <i>Port Monitor</i> function detects that the parameters have been exceeded.</p> <p>Possible values:</p> <ul style="list-style-type: none"> ▶ disable port The device disables the port and sends an SNMP trap. The “Link status” LED for the port flashes 3× per period. <ul style="list-style-type: none"> – To re-enable the port, highlight the port and click the  button and then the <i>Reset</i> item. – The <i>Auto-Disable</i> function enables the port again after the specified waiting period when the parameters are no longer being exceeded. The prerequisite is that on the <i>Auto-disable</i> tab the checkbox for the monitored parameter is marked. ▶ send trap The device sends an SNMP trap. The prerequisite for sending SNMP traps is that you enable the function in the <i>Diagnostics > Status Configuration > Alarms (Traps)</i> dialog and specify at least 1 trap destination. ▶ auto-disable (default setting) The device disables the port and sends an SNMP trap. The “Link status” LED for the port flashes 3× per period. The prerequisite is that on the <i>Auto-disable</i> tab the checkbox for the monitored parameter is marked. <ul style="list-style-type: none"> – The <i>Diagnostics > Ports > Auto-Disable</i> dialog displays which ports are currently disabled due to the parameters being exceeded. – The <i>Auto-Disable</i> function reactivates the port automatically. For this you go to the <i>Diagnostics > Ports > Auto-Disable</i> dialog and specify a waiting period for the relevant port in the <i>Reset timer [s]</i> column. |
| Port status | <p>Displays the operating state of the port.</p> <p>Possible values:</p> <ul style="list-style-type: none"> ▶ up The port is enabled. ▶ down The port is disabled. ▶ notPresent Physical port unavailable. |

■ Buttons

You find the description of the standard buttons in section “Buttons” on page 18.

| Button | Meaning |
|---|---|
|  | Displays a sub menu with the following items. |
| Reset | <p>Enables the port highlighted in the table again and resets its counter to 0. This affects the counters in the following dialogs:</p> <ul style="list-style-type: none"> ▶ <i>Diagnostics > Ports > Port Monitor</i> dialog <ul style="list-style-type: none"> – <i>Link flap</i> tab – <i>CRC/Fragments</i> tab – <i>Overload detection</i> tab ▶ <i>Diagnostics > Ports > Auto-Disable</i> dialog |

[Auto-disable]

In this tab, you activate the *Auto-Disable* function for the parameters monitored by the *Port Monitor* function.

■ Table

| Parameters | Meaning |
|--------------|---|
| Reason | <p>Displays the parameters monitored by the <i>Port Monitor</i> function.</p> <p>Mark the adjacent checkbox so that the <i>Port Monitor</i> function carries out the <i>auto-disable</i> action when it detects that the monitored parameters have been exceeded.</p> |
| Auto-disable | <p>Activates/deactivates the <i>Auto-Disable</i> function for the adjacent parameters.</p> <p>Possible values:</p> <ul style="list-style-type: none"> ▶ <i>marked</i> The <i>Auto-Disable</i> function for the adjacent parameters is active. When the adjacent parameters are exceeded, the device carries out the <i>Auto-Disable</i> function when the value <i>auto-disable</i> is specified in the <i>Action</i> column. ▶ <i>unmarked</i> (default setting) The <i>Auto-Disable</i> function for the adjacent parameters is inactive. |

■ Buttons

You find the description of the standard buttons in section “Buttons” on page 18.

| Button | Meaning |
|---|---|
|  | Displays a sub menu with the following items. |
| Reset | Enables the port highlighted in the table again and resets its counter to 0. This affects the counters in the following dialogs: <ul style="list-style-type: none">▶ <i>Diagnostics > Ports > Port Monitor</i> dialog<ul style="list-style-type: none">– <i>Link flap</i> tab– <i>CRC/Fragments</i> tab– <i>Overload detection</i> tab▶ <i>Diagnostics > Ports > Auto-Disable</i> dialog |

[Link flap]

In this tab, you specify individually for every port the following settings:

- ▶ The number of link changes.
- ▶ The period during which the *Port Monitor* function monitors a parameter to detect discrepancies.

You also see how many link changes the *Port Monitor* function has detected up to now.

The *Port Monitor* function monitors those ports for which the checkbox in the *Link flap on* column is marked on the *Global* tab.

■ Table

| Parameters | Meaning |
|------------------------|---|
| Port | Displays the port number. |
| Sampling interval [s] | Specifies in seconds, the period during which the <i>Port Monitor</i> function monitors a parameter to detect discrepancies. Possible values: <ul style="list-style-type: none">▶ 1..180 (default setting: 10) |
| Link flaps | Specifies the number of link changes. If the <i>Port Monitor</i> function detects this number of link changes in the monitored period, the device performs the specified action. Possible values: <ul style="list-style-type: none">▶ 1..100 (default setting: 5) |
| Last sampling interval | Displays the number of errors that the device has detected during the period that has elapsed. |
| Total | Displays the total number of errors that the device has detected since the port was enabled. |

■ Buttons

You find the description of the standard buttons in section “Buttons” on page 18.

| Button | Meaning |
|---|---|
|  | Displays a sub menu with the following items. |
| Reset | <p>Enables the port highlighted in the table again and resets its counter to 0. This affects the counters in the following dialogs:</p> <ul style="list-style-type: none"> ▶ <i>Diagnostics > Ports > Port Monitor</i> dialog <ul style="list-style-type: none"> – <i>Link flap</i> tab – <i>CRC/Fragments</i> tab – <i>Overload detection</i> tab ▶ <i>Diagnostics > Ports > Auto-Disable</i> dialog |

[CRC/Fragments]

In this tab, you specify individually for every port the following settings:

- ▶ The fragment error rate.
- ▶ The period during which the *Port Monitor* function monitors a parameter to detect discrepancies.

You also see the fragment error rate that the device has detected up to now.

The *Port Monitor* function monitors those ports for which the checkbox in the *CRC/Fragments on* column is marked on the *Global* tab.

■ Table

| Parameters | Meaning |
|----------------------------|---|
| Port | Displays the port number. |
| Sampling interval [s] | <p>Specifies in seconds, the period during which the <i>Port Monitor</i> function monitors a parameter to detect discrepancies.</p> <p>Possible values:</p> <ul style="list-style-type: none"> ▶ 5..180 (default setting: 10) |
| CRC/Fragments count [ppm] | <p>Specifies the fragment error rate (in parts per million). If the <i>Port Monitor</i> function detects this fragment error rate in the monitored period, the device performs the specified action.</p> <p>Possible values:</p> <ul style="list-style-type: none"> ▶ 1..1000000 (default setting: 1000) |
| Last active interval [ppm] | Displays the fragment error rate that the device has detected during the period that has elapsed. |
| Total [ppm] | Displays the fragment error rate that the device has detected since the port was enabled. |

■ Buttons

You find the description of the standard buttons in section “Buttons” on page 18.

| Button | Meaning |
|---|---|
|  | Displays a sub menu with the following items. |
| Reset | <p>Enables the port highlighted in the table again and resets its counter to 0. This affects the counters in the following dialogs:</p> <ul style="list-style-type: none"> ▶ <i>Diagnostics > Ports > Port Monitor</i> dialog <ul style="list-style-type: none"> – <i>Link flap</i> tab – <i>CRC/Fragments</i> tab – <i>Overload detection</i> tab ▶ <i>Diagnostics > Ports > Auto-Disable</i> dialog |

[Overload detection]

In this tab, you specify individually for every port the following settings:

- ▶ The load threshold values.
- ▶ The period during which the *Port Monitor* function monitors a parameter to detect discrepancies.

You also see the number of data packets that the device has detected up to now.

The *Port Monitor* function monitors those ports for which the checkbox in the *Overload detection on* column is marked on the *Global* tab.

The *Port Monitor* function does not monitor any ports that are members of a link aggregation group or PRP/HSR subscribers.

■ Table

| Parameters | Meaning |
|----------------|---|
| Port | Displays the port number. |
| Traffic type | <p>Specifies the type of data packets that the device considers when monitoring the load on the port.</p> <p>Possible values:</p> <ul style="list-style-type: none"> ▶ <i>all</i> The <i>Port Monitor</i> function monitors Broadcast, Multicast and Unicast packets. ▶ <i>bc</i> (default setting) The <i>Port Monitor</i> function monitors only Broadcast packets. ▶ <i>bc-mc</i> The <i>Port Monitor</i> function monitors only Broadcast and Multicast packets. |
| Threshold type | <p>Specifies the unit for the data rate.</p> <p>Possible values:</p> <ul style="list-style-type: none"> ▶ <i>pps</i> (default setting) packets per second ▶ <i>kbps</i> kbit per second <p>The prerequisite is that the value in the <i>Traffic type</i> column = <i>all</i>.</p> |

| Parameters | Meaning |
|-------------------|---|
| Lower threshold | <p>Specifies the lower threshold value for the data rate. The <i>Auto-Disable</i> function enables the port again only when the load on the port is lower than the value specified here.</p> <p>Possible values: ▶ 0..10000000 (default setting: 0)</p> |
| Upper threshold | <p>Specifies the upper threshold value for the data rate. If the <i>Port Monitor</i> function detects this load in the monitored period, the device performs the specified action.</p> <p>Possible values: ▶ 0..10000000 (default setting: 0)</p> |
| Interval [s] | <p>Specifies in seconds, the period that the <i>Port Monitor</i> function observes a parameter to detect that a parameter is being exceeded.</p> <p>Possible values: ▶ 1..20 (default setting: 1)</p> |
| Packets | Displays the number of Broadcast, Multicast and Unicast packets that the device has detected during the period that has elapsed. |
| Broadcast packets | Displays the number of Broadcast packets that the device has detected during the period that has elapsed. |
| Multicast packets | Displays the number of Multicast packets that the device has detected during the period that has elapsed. |
| Kbit/s | Displays the data rate in Kbits per second that the device has detected during the period that has elapsed. |

■ Buttons

You find the description of the standard buttons in section “Buttons” on page 18.

| Button | Meaning |
|---|---|
|  | Displays a sub menu with the following items. |
| Reset | <p>Enables the port highlighted in the table again and resets its counter to 0. This affects the counters in the following dialogs:</p> <ul style="list-style-type: none"> ▶ <i>Diagnostics > Ports > Port Monitor</i> dialog <ul style="list-style-type: none"> - <i>Link flap</i> tab - <i>CRC/Fragments</i> tab - <i>Overload detection</i> tab ▶ <i>Diagnostics > Ports > Auto-Disable</i> dialog |

[Link speed/Duplex mode detection]

In this tab, you activate the allowed combinations of speed and duplex mode for each port.

The *Port Monitor* function monitors those ports for which the checkbox in the *Link speed/Duplex mode detection on* column is marked on the *Global* tab.

The *Port Monitor* function monitors only enabled physical ports.

■ Table

| Parameters | Meaning |
|------------------|--|
| Port | Displays the port number. |
| 10 Mbit/s HDX | Activates/deactivates the port monitor to accept a half-duplex and 10 Mbit/s data rate combination on the port. Possible values: <ul style="list-style-type: none">▶ marked The port monitor allows the speed and duplex combination.▶ unmarked If the port monitor detects the speed and duplex combination on the port, then the device executes the action specified in the <i>Global</i> tab. |
| 10 Mbit/s FDX | Activates/deactivates the port monitor to accept a full-duplex and 10 Mbit/s data rate combination on the port. Possible values: <ul style="list-style-type: none">▶ marked The port monitor allows the speed and duplex combination.▶ unmarked If the port monitor detects the speed and duplex combination on the port, then the device executes the action specified in the <i>Global</i> tab. |
| 100 Mbit/s HDX | Activates/deactivates the port monitor to accept a half-duplex and 100 Mbit/s data rate combination on the port. Possible values: <ul style="list-style-type: none">▶ marked The port monitor allows the speed and duplex combination.▶ unmarked If the port monitor detects the speed and duplex combination on the port, then the device executes the action specified in the <i>Global</i> tab. |
| 100 Mbit/s FDX | Activates/deactivates the port monitor to accept a full-duplex and 100 Mbit/s data rate combination on the port. Possible values: <ul style="list-style-type: none">▶ marked The port monitor allows the speed and duplex combination.▶ unmarked If the port monitor detects the speed and duplex combination on the port, then the device executes the action specified in the <i>Global</i> tab. |
| 1,000 Mbit/s FDX | Activates/deactivates the port monitor to accept a full-duplex and 1 Gbit/s data rate combination on the port. Possible values: <ul style="list-style-type: none">▶ marked The port monitor allows the speed and duplex combination.▶ unmarked If the port monitor detects the speed and duplex combination on the port, then the device executes the action specified in the <i>Global</i> tab. |

■ Buttons

You find the description of the standard buttons in section [“Buttons” on page 18](#).

| Button | Meaning |
|---|---|
|  | Displays a sub menu with the following items. |
| Reset | <p>Enables the port highlighted in the table again and resets its counter to 0. This affects the counters in the following dialogs:</p> <ul style="list-style-type: none"> ▶ <i>Diagnostics > Ports > Port Monitor</i> dialog <ul style="list-style-type: none"> – <i>Link flap</i> tab – <i>CRC/Fragments</i> tab – <i>Overload detection</i> tab ▶ <i>Diagnostics > Ports > Auto-Disable</i> dialog |

6.4.3 Auto-Disable

The *Auto-Disable* function allows you to disable monitored ports automatically and enable them again as you desire.

For example, the *Port Monitor* function and selected functions in the *Network Security* menu use the *Auto-Disable* function to disable ports when monitored parameters are exceeded.

When the parameters are no longer being exceeded, the *Auto-Disable* function enables the relevant port again after a specified waiting period.

The dialog contains the following tabs:

- ▶ [Port]
- ▶ [Status]

[Port]

This tab displays which ports are currently disabled due to the parameters being exceeded. When you specify a waiting period in the *Reset timer [s]* column, the *Auto-Disable* function automatically enables the relevant port again when the parameters are no longer being exceeded.

■ Table

| Parameters | Meaning |
|--------------------|---|
| Port | Displays the port number. |
| Reset timer [s] | Specifies the waiting period in seconds, after which the <i>Auto-Disable</i> function enables the port again. Possible values: <ul style="list-style-type: none">▶ 0 (default setting) The timer is inactive. The port remains disabled.▶ 30..4294967295 The <i>Auto-Disable</i> function enables the port again after the waiting period specified here and when the parameters are no longer being exceeded. |
| Error time | Displays when the device disabled the port due to the parameters being exceeded. |
| Remaining time [s] | Displays the remaining time in seconds, until the <i>Auto-Disable</i> function enables the port again. |
| Component | Displays the software component in the device that disabled the port. Possible values: <ul style="list-style-type: none">▶ PORT_MON <i>Port Monitor</i> See the <i>Diagnostics > Ports > Port Monitor</i> dialog.▶ PORT_ML <i>Port Security</i> See the <i>Network Security > Port Security</i> dialog.▶ DOT1S <i>BPDU guard</i> See the <i>Switching > L2-Redundancy > Spanning Tree > Global</i> dialog. |

| Parameters | Meaning |
|------------|--|
| Reason | <p>Displays the monitored parameter that led to the port being disabled.</p> <p>Possible values:</p> <ul style="list-style-type: none"> ▶ none No monitored parameter. The port is enabled. ▶ link-flap Too many link changes. See the <i>Diagnostics > Ports > Port Monitor</i> dialog, <i>Link flap</i> tab. ▶ crc-error Too many CRC/fragment errors. See the <i>Diagnostics > Ports > Port Monitor</i> dialog, <i>CRC/Fragments</i> tab. ▶ duplex-mismatch Duplex mismatch detected. See the <i>Diagnostics > Ports > Port Monitor</i> dialog, <i>Global</i> tab. ▶ bpdu-rate STP-BPDUs received. See the <i>Switching > L2-Redundancy > Spanning Tree > Global</i> dialog. ▶ mac-based-port-security Too many data packets from undesired senders. See the <i>Network Security > Port Security</i> dialog. ▶ overload-detection Overload. See the <i>Diagnostics > Ports > Port Monitor</i> dialog, <i>Overload detection</i> tab. ▶ speed-duplex Impermissible combination of speed and duplex mode detected. See the <i>Diagnostics > Ports > Port Monitor</i> dialog, <i>Link speed/Duplex mode detection</i> tab. |
| Active | <p>Displays whether the port is currently disabled due to the parameters being exceeded.</p> <p>Possible values:</p> <ul style="list-style-type: none"> ▶ marked The port is currently disabled. ▶ unmarked The port is enabled. |

■ Buttons

You find the description of the standard buttons in section “Buttons” on page 18.

[Status]

This tab displays the monitored parameters for which the *Auto-Disable* function is activated.

■ Table

| Parameters | Meaning |
|------------|---|
| Reason | <p>Displays the parameters that the device monitors.</p> <p>Mark the adjacent checkbox so that the <i>Auto-Disable</i> function disables and, if applicable, enables the port again when the monitored parameters are exceeded.</p> |

| Parameters | Meaning |
|--------------|---|
| Category | Displays which function the adjacent parameter belongs to. Possible values: <ul style="list-style-type: none">▶ port-monitor The parameter belongs to the <i>Port Monitor</i> function. See the <i>Diagnostics > Port > Port Monitor</i> dialog.▶ network-security The parameter belongs to the functions in the <i>Network Security</i> menu.▶ l2-redundancy The parameter belongs to the <i>L2-Redundancy</i> functions. See the <i>Switching > L2-Redundancy</i> dialog. |
| Auto-disable | Displays whether the <i>Auto-Disable</i> function is activated/deactivated for the adjacent parameter. Possible values: <ul style="list-style-type: none">▶ marked The <i>Auto-Disable</i> function for the adjacent parameters is active. The <i>Auto-Disable</i> function disables and, if applicable, enables the relevant port again when the monitored parameters are exceeded.▶ unmarked (default setting) The <i>Auto-Disable</i> function for the adjacent parameters is inactive. |

■ Buttons

You find the description of the standard buttons in section “Buttons” on page 18.

| Button | Meaning |
|---|---|
|  | Displays a sub menu with the following items. |
| Reset | Enables the port highlighted in the table again and resets its counter to 0. This affects the counters in the following dialogs: <ul style="list-style-type: none">▶ <i>Diagnostics > Ports > Port Monitor</i> dialog<ul style="list-style-type: none">– <i>Link flap</i> tab– <i>CRC/Fragments</i> tab– <i>Overload detection</i> tab▶ <i>Diagnostics > Ports > Auto-Disable</i> dialog |

6.4.4 Port Mirroring

The *Port Mirroring* function allows you to copy received and sent data packets from selected ports to a destination port. You can watch and process the data stream using an analyzer or an RMON probe, connected to the destination port. The data packets remain unmodified on the source port.

Note: To enable the management access using the destination port, mark the checkbox *Allow management* in the *Destination port* frame before you enable the *Port Mirroring* function.

■ Operation

| Parameters | Meaning |
|------------|---|
| Operation | <p>Enables/disables the <i>Port Mirroring</i> function.</p> <p>Possible values:</p> <ul style="list-style-type: none"> ▶ On The <i>Port Mirroring</i> function is enabled. The device copies the data packets from the selected source ports to the destination port. ▶ Off (default setting) The <i>Port Mirroring</i> function is disabled. |

■ Destination port

| Parameters | Meaning |
|--------------|--|
| Primary port | <p>Specifies the destination port.</p> <p>Suitable ports are those ports that are not used for the following purposes:</p> <ul style="list-style-type: none"> – Source port – L2 redundancy protocols <p>Possible values:</p> <ul style="list-style-type: none"> ▶ no Port (default setting) No destination port selected. ▶ <Port number> Number of the destination port. The device copies the data packets from the source ports to this port. <p>On the destination port, the device adds a VLAN tag to the data packets that the source port transmits. The destination port transmits unmodified the data packets that the source port receives.</p> <p>Note: The destination port needs sufficient bandwidth to absorb the data stream. When the copied data stream exceeds the bandwidth of the destination port, the device discards surplus data packets on the destination port.</p> |

| Parameters | Meaning |
|------------------|--|
| Allow management | <p>Activates/deactivates the management access using the destination port.</p> <p>Possible values:</p> <ul style="list-style-type: none"> ▶ <code>marked</code> The management access using the destination port is active. The device allows the management access to the device using the destination port without interrupting the active <i>Port Mirroring</i> session. <ul style="list-style-type: none"> – The device duplicates multicasts, broadcasts and unknown unicasts on the destination port. – The VLAN settings on the destination port remain unchanged. The prerequisite for management access via the destination port is that the destination port is not a member of the management VLAN. ▶ <code>unmarked</code> (default setting) The management access using the destination port is inactive. The device prohibits the management access to the device using the destination port. |

■ Table

| Parameters | Meaning |
|-------------|---|
| Source port | <p>Specifies the port number.</p> <p>Possible values:</p> <ul style="list-style-type: none"> ▶ <code><Port number></code> |
| Enabled | <p>Activates/deactivates the copying of the data packets from this source port to the destination port.</p> <p>Possible values:</p> <ul style="list-style-type: none"> ▶ <code>marked</code> The copying of the data packets is active. The port is specified as a source port. ▶ <code>unmarked</code> (default setting) The copying of the data packets is inactive. ▶ (Grayed-out display) It is not possible to copy the data packets for this port. Possible causes: <ul style="list-style-type: none"> – The port is already specified as a destination port. – The port is a logical port, not a physical port. <p>Note: The device allows you to activate every physical port as source port except for the destination port.</p> |
| Type | <p>Specifies which data packets the device copies to the destination port.</p> <p>Possible values:</p> <ul style="list-style-type: none"> ▶ <code>none</code> (default setting) No data packets. ▶ <code>tx</code> Data packets that the source port transmits. ▶ <code>rx</code> Data packets that the source port receives. ▶ <code>txrx</code> Data packets that the source port transmits and receives. <p>Note: With the <code>txrx</code> setting the device copies transmitted and received data packets. The destination ports needs at least a bandwidth that corresponds to the sum of the send and receive channel of the source ports. For example, for similar ports the destination port is at 100 % capacity when the send and receive channel of a source port are at 50 % capacity respectively.</p> <p>On the destination port, the device adds a VLAN tag to the data packets that the source port transmits. The destination port transmits unmodified the data packets that the source port receives.</p> |

■ Buttons

You find the description of the standard buttons in section [“Buttons” on page 18](#).

| Button | Meaning |
|---|---|
|  | Displays a sub menu with the following items. |
| Reset config | Resets the settings in the dialog to the default settings and transfers the changes to the volatile memory of the device (RAM). |

6.5 LLDP

The device allows you to gather information about neighboring devices. For this, the device uses the Link Layer Discovery Protocol (LLDP). This information enables a network management station to map the structure of your network.

This menu allows you to configure the topology discovery and to display the information received in table form.

The menu contains the following dialogs:

- ▶ [LLDP Configuration](#)
- ▶ [LLDP Topology Discovery](#)

6.5.1 LLDP Configuration

This dialog allows you to configure the topology discovery for every port.

■ Operation

| Parameters | Meaning |
|------------|---|
| Operation | <p>Enables/disables the <i>LLDP</i> function.</p> <p>Possible values:</p> <ul style="list-style-type: none"> ▶ On (default setting) The <i>LLDP</i> function is enabled. The topology discovery using LLDP is active on the device. ▶ Off The <i>LLDP</i> function is disabled. |

■ Configuration

| Parameters | Meaning |
|------------------------------|---|
| Transmit interval [s] | <p>Specifies the interval in seconds at which the device transmits LLDP data packets.</p> <p>Possible values:</p> <ul style="list-style-type: none"> ▶ 5..32768 (default setting: 30) |
| Transmit interval multiplier | <p>Specifies the factor for determining the time-to-live value for the LLDP data packets.</p> <p>Possible values:</p> <ul style="list-style-type: none"> ▶ 2..10 (default setting: 4) <p>The time-to-live value coded in the LLDP header results from multiplying this value with the value in the <i>Transmit interval [s]</i> field.</p> |
| Reinit delay [s] | <p>Specifies the delay in seconds for the reinitialization of a port.</p> <p>Possible values:</p> <ul style="list-style-type: none"> ▶ 1..10 (default setting: 2) <p>If in the <i>Operation</i> column the value <code>Off</code> is specified, the device tries to reinitialize the port after the time specified here has elapsed.</p> |
| Transmit delay [s] | <p>Specifies the delay in seconds for transmitting successive LLDP data packets after configuration changes in the device occur.</p> <p>Possible values:</p> <ul style="list-style-type: none"> ▶ 1..8192 (default setting: 2) <p>The recommended value is between a minimum of 1 and a maximum of a quarter of the value in the <i>Transmit interval [s]</i> field.</p> |
| Notification interval [s] | <p>Specifies the interval in seconds for transmitting LLDP notifications.</p> <p>Possible values:</p> <ul style="list-style-type: none"> ▶ 5..3600 (default setting: 5) <p>After transmitting a notification trap, the device waits for a minimum of the time specified here before transmitting the next notification trap.</p> |

■ **Table**

| Parameters | Meaning |
|------------------------------|---|
| Port | Displays the port number. |
| Operation | <p>Specifies whether the port transmits and receives LLDP data packets.</p> <p>Possible values:</p> <ul style="list-style-type: none"> ▶ transmit The port transmits LLDP data packets but does not save any information about neighboring devices. ▶ receive The port receives LLDP data packets but does not transmit any information to neighboring devices. ▶ receive and transmit (default setting) The port transmits LLDP data packets and saves information about neighboring devices. ▶ disabled The port does not transmit LLDP data packets and does not save information about neighboring devices. |
| Notification | <p>Activates/deactivates the LLDP notifications on the port.</p> <p>Possible values:</p> <ul style="list-style-type: none"> ▶ marked LLDP notifications are active on the port. ▶ unmarked (default setting) LLDP notifications are inactive on the port. |
| Transmit port description | <p>Activates/deactivates the transmitting of a TLV (Type Length Value) with the port description.</p> <p>Possible values:</p> <ul style="list-style-type: none"> ▶ marked (default setting) The transmitting of the TLV is active. The device transmits the TLV with the port description. ▶ unmarked The transmitting of the TLV is inactive. The device does not transmit a TLV with the port description. |
| Transmit system name | <p>Activates/deactivates the transmitting of a TLV (Type Length Value) with the device name.</p> <p>Possible values:</p> <ul style="list-style-type: none"> ▶ marked (default setting) The transmitting of the TLV is active. The device transmits the TLV with the device name. ▶ unmarked The transmitting of the TLV is inactive. The device does not transmit a TLV with the device name. |
| Transmit system description | <p>Activates/deactivates the transmitting of the TLV (Type Length Value) with the system description.</p> <p>Possible values:</p> <ul style="list-style-type: none"> ▶ marked (default setting) The transmitting of the TLV is active. The device transmits the TLV with the system description. ▶ unmarked The transmitting of the TLV is inactive. The device does not transmit a TLV with the system description. |
| Transmit system capabilities | <p>Activates/deactivates the transmitting of the TLV (Type Length Value) with the system capabilities.</p> <p>Possible values:</p> <ul style="list-style-type: none"> ▶ marked (default setting) The transmitting of the TLV is active. The device transmits the TLV with the system capabilities. ▶ unmarked The transmitting of the TLV is inactive. The device does not transmit a TLV with the system capabilities. |
| Neighbors (max.) | <p>Limits the number of neighboring devices to be recorded for this port.</p> <p>Possible values:</p> <ul style="list-style-type: none"> ▶ 1..50 (default setting: 10) |

| Parameters | Meaning |
|------------|--|
| FDB mode | <p>Specifies which function the device uses to record neighboring devices on this port.</p> <p>Possible values:</p> <ul style="list-style-type: none"> ▶ <code>lldpOnly</code> The device uses LLDP data packets exclusively to record neighboring devices on this port. ▶ <code>macOnly</code> The device uses learned MAC addresses to record neighboring devices on this port. The device uses the MAC address exclusively if there is no other entry in the address table (FDB, Forwarding Database) for this port. ▶ <code>both</code> The device uses LLDP data packets and learned MAC addresses to record neighboring devices on this port. ▶ <code>autoDetect</code> (default setting) If the device receives LLDP data packets at this port, the device works the same as with the <code>lldpOnly</code> setting. Otherwise, the device works the same as with the <code>macOnly</code> setting. |

■ Buttons

You find the description of the standard buttons in section [“Buttons” on page 18](#).

6.5.2 LLDP Topology Discovery

Devices in networks send notifications in the form of packets which are also known as "LLDPDU" (LLDP data units). The data that is sent and received via LLDPDU are useful for many reasons. Thus the device detects which devices in the network are neighbors and via which ports they are connected.

The dialog allows you to display the network and to detect the connected devices along with their specific features.

The dialog contains the following tabs:

- ▶ [\[LLDP \]](#)
- ▶ [\[LLDP-MED \]](#)

[LLDP]

This tab displays the collected LLDP information for the neighboring devices. This information enables a network management station to map the structure of your network.

When devices both with and without an active topology discovery function are connected to a port, the topology table hides the devices without active topology discovery.

When devices without active topology discovery are connected to a port exclusively, then the table contains one line for this port to represent every device. This line contains the number of connected devices.

The Forwarding Database (FDB) address table contains MAC addresses of devices that the topology table hides for the sake of clarity.

If you use 1 port to connect several devices, for example via a hub, the table contains 1 line for each connected device.

■ Table

| Parameters | Meaning |
|-----------------------------|--|
| Port | Displays the port number. |
| Neighbor identifier | Displays the chassis ID of the neighboring device. This can be the basis MAC address of the neighboring device, for example. |
| FDB | Displays whether or not the connected device has active LLDP support. Possible values: ▶ <code>marked</code> The connected device does not have active LLDP support. The device uses information from its address table (FDB, Forwarding Database) ▶ <code>unmarked</code> (default setting) The connected device has active LLDP support. |
| Neighbor IP address | Displays the IP address with which the management access to the neighboring device is possible. |
| Neighbor port description | Displays a description for the port of the neighboring device. |
| Neighbor system name | Displays the device name of the neighboring device. |
| Neighbor system description | Displays a description for the neighboring device. |
| Port ID | Displays the ID of the port through which the neighboring device is connected to the device. |
| Autonegotiation supported | Displays whether the port of the neighboring device supports autonegotiation. |
| Autonegotiation | Displays whether autonegotiation is enabled on the port of the neighboring device. |
| PoE supported | Displays whether the port of the neighboring device supports Power over Ethernet (PoE). |
| PoE enabled | Displays whether Power over Ethernet (PoE) is enabled on the port of the neighboring device. |

■ Buttons

You find the description of the standard buttons in section [“Buttons” on page 18](#).

[LLDP-MED]

LLDP for Media Endpoint Devices (LLDP-MED) is an extension to LLDP that operates between endpoint devices and network devices. It specifically provides support for VoIP applications. In this support rule, it provides an additional set of common advertisement, Type Length Value (TLV), messages. The device uses the TLVs for capabilities discovery such as network policy, Power over Ethernet, inventory management and location information.

■ Table

| Parameters | Meaning |
|--------------------|--|
| Port | Displays the port number. |
| Device class | Displays the device class of the remotely connected device. <ul style="list-style-type: none"> ▶ A value of <code>notDefined</code> indicates that the device has capabilities not covered by any of the <i>LLDP-MED</i> classes. ▶ A value of <code>endpointClass1..3</code> indicates that the device has "endpoint class 1..3" capabilities. ▶ A value of <code>networkConnectivity</code> indicates that the device has network connectivity device capabilities. |
| VLAN ID | Displays the extension of the VLAN Identifier for the remote system connected to this port, as defined in IEEE 802.3. <ul style="list-style-type: none"> ▶ The device uses a value from 1 through 4042 to specify a valid Port VLAN ID. ▶ The device displays the value 0 for priority tagged packets. This means that only the 802.1D priority is significant and the device uses the default VLAN ID of the ingress port. |
| Priority | Displays the value of the 802.1D priority which is associated with the remote system connected to the port. |
| DSCP | Displays the value of the Differentiated Service Code Point (DSCP) which is associated with the remote system connected to the port. |
| Unknown bit status | Displays the unknown bit status of incoming traffic. <ul style="list-style-type: none"> ▶ A value of <code>true</code> indicates that the network policy for the specified application type is currently unknown. In this case, the VLAN ID ignores the Layer 2 priority and value of the <i>DSCP</i> field. ▶ A value of <code>false</code> indicates a specified network policy. |
| Tagged bit status | Displays the tagged bit status. <ul style="list-style-type: none"> ▶ A value of <code>true</code> indicates that the application uses a tagged VLAN. ▶ A value of <code>false</code> indicates that for the specific application the device uses untagged VLAN operation. In this case, the device ignores both the VLAN ID and the Layer 2 priority fields. The DSCP value, however, is relevant. |
| Hardware revision | Displays the vendor-specific hardware revision string as advertised by the remote endpoint. |
| Firmware revision | Displays the vendor-specific firmware revision string as advertised by the remote endpoint. |
| Software revision | Displays the vendor-specific software revision string as advertised by the remote endpoint. |
| Serial number | Displays the vendor-specific serial number as advertised by the remote endpoint. |
| Manufacturer name | Displays the vendor-specific manufacturer name as advertised by the remote endpoint. |
| Model name | Displays the vendor-specific model name as advertised by the remote endpoint. |
| Asset ID | Displays the vendor-specific asset tracking identifier as advertised by the remote endpoint. |

■ Buttons

You find the description of the standard buttons in section [“Buttons” on page 18](#).

6.6 Report

The menu contains the following dialogs:

- ▶ [Report Global](#)
- ▶ [Persistent Logging](#)
- ▶ [System Log](#)
- ▶ [Audit Trail](#)

6.6.1 Report Global

The device allows you to log specific events using the following outputs:

- ▶ on the console
- ▶ on one or more syslog servers
- ▶ on a CLI connection set up using SSH
- ▶ on a CLI connection set up using Telnet

In this dialog, you specify the required settings. By assigning the severity you specify which events the device registers.

The dialog allows you to save a ZIP archive with system information on your PC.

■ Console logging

| Parameters | Meaning |
|------------|---|
| Operation | Enables/disables the <i>Console logging</i> function. Possible values: <ul style="list-style-type: none">▶ On The <i>Console logging</i> function is enabled. The device logs the events on the console.▶ Off (default setting) The <i>Console logging</i> function is disabled. |
| Severity | Specifies the minimum severity for the events. The device logs events with this severity and with more urgent severities. The device outputs the messages on the V.24 interface. Possible values: <ul style="list-style-type: none">▶ emergency▶ alert▶ critical▶ error▶ warning (default setting)▶ notice▶ informational▶ debug |

■ Buffered logging

The device buffers logged events in 2 separate storage areas so that the log entries for urgent events are kept.

This dialog allows you to specify the minimum severity for events that the device buffers in the storage area with a higher priority.

| Parameters | Meaning |
|------------|---|
| Severity | <p>Specifies the minimum severity for the events. The device buffers log entries for events with this severity and with more urgent severities in the storage area with a higher priority.</p> <p>Possible values:</p> <ul style="list-style-type: none"> ▶ emergency ▶ alert ▶ critical ▶ error ▶ warning (default setting) ▶ notice ▶ informational ▶ debug |

■ SNMP logging

| Parameters | Meaning |
|----------------------|---|
| Log SNMP get request | <p>Enables/disables the logging of SNMP Get requests.</p> <p>Possible values:</p> <ul style="list-style-type: none"> ▶ On The logging is enabled. The device registers SNMP Get requests as events in the syslog. In the <i>Severity get request</i> drop-down list, you select the severity for this event. ▶ Off (default setting) The logging is disabled. |
| Log SNMP set request | <p>Enables/disables the logging of SNMP Set requests.</p> <p>Possible values:</p> <ul style="list-style-type: none"> ▶ On The logging is enabled. The device registers SNMP Set requests as events in the syslog. In the <i>Severity set request</i> drop-down list, you select the severity for this event. ▶ Off (default setting) The logging is disabled. |
| Severity get request | <p>Specifies the severity of the event that the device registers for SNMP Get requests.</p> <p>Possible values:</p> <ul style="list-style-type: none"> ▶ emergency ▶ alert ▶ critical ▶ error ▶ warning ▶ notice (default setting) ▶ informational ▶ debug |
| Severity set request | <p>Specifies the severity of the event that the device registers for SNMP Set requests.</p> <p>Possible values:</p> <ul style="list-style-type: none"> ▶ emergency ▶ alert ▶ critical ▶ error ▶ warning ▶ notice (default setting) ▶ informational ▶ debug |

When you enable the logging of SNMP requests, the device sends these as events with the preset severity `notice` to the list of syslog servers. The preset minimum severity for a syslog server entry is `critical`.

To send SNMP requests to a syslog server, you have a number of options to change the default settings. Select the ones that meet your requirements best.

- Set the severity for which the device creates SNMP requests as events to `warning` or `error` and change the minimum severity for a syslog entry for one or more syslog servers to the same value. You also have the option of creating a separate syslog server entry for this.
- When you set the severity for SNMP requests to `critical` or higher. The device then sends SNMP requests as events with the severity `critical` or higher to the syslog servers.
- When you set the minimum severity for one or more syslog server entries to `notice` or lower. Then it is possible that the device sends many events to the syslog servers.

■ CLI logging

| Parameters | Meaning |
|------------|--|
| Operation | Enables/disables the <i>CLI logging</i> function. Possible values: <ul style="list-style-type: none"> ▶ On The <i>CLI logging</i> function is enabled. The device logs every command received using the Command Line Interface (CLI). ▶ Off (default setting) The <i>CLI logging</i> function is disabled. |

■ Buttons

You find the description of the standard buttons in section “Buttons” on page 18.

| Button | Meaning |
|---|---|
|  | Displays a sub menu with the following items. |
| Download support information | Generates a ZIP archive which the web browser offers to you for download on your PC. The ZIP archive contains system information about the device. You will find an explanation of the files contained in the ZIP archive in the following section. |

■ Support Information: Files contained in ZIP archive

| File name | Format | Comments |
|-------------------|--------|--|
| audittrail.html | HTML | Contains the chronological recording of the system events and saved user changes in the Audit Trail. |
| defaultconfig.xml | XML | Contains the configuration profile with the default settings. |
| script | TEXT | Contains the output of CLI command <code>show running-config script</code> . |
| runningconfig.xml | XML | Contains the configuration profile with the current operating settings. |
| supportinfo.html | TEXT | Contains device internal service information. |
| systeminfo.html | HTML | Contains information about the current settings and operating parameters. |
| systemlog.html | HTML | Contains the logged events in the Log file. See the <i>Diagnostics > Report > System Log</i> dialog. |

■ **Meaning of the severities for events**

| Severity | Meaning |
|-----------------|--------------------------------------|
| emergency | Device not ready for operation |
| alert | Immediate user intervention required |
| critical | Critical status |
| error | Error status |
| warning | Warning |
| notice | Significant, normal status |
| informational | Informal message |
| debug | Debug message |

6.6.2 Persistent Logging

The device allows you to save log entries permanently in a file on the external memory. Therefore, even after the device is restarted you have access to the log entries.

In this dialog, you limit the size of the log file and specify the minimum severity for the events to be saved. If the log file attains the specified size, the device archives this file and saves the following log entries in a newly created file.

In the table the device displays you the log files held on the external memory. As soon as the specified maximum number of files has been attained, the device deletes the oldest file and renames the remaining files. This ensures that there is always enough memory space on the external memory.

■ Operation

| Parameters | Meaning |
|------------|---|
| Operation | Enables/disables the <i>Persistent Logging</i> function. Only activate this function when the external memory is available on the device. Possible values: <ul style="list-style-type: none">▶ On (default setting) The <i>Persistent Logging</i> function is enabled. The device saves the log entries in a file on the external memory.▶ Off The <i>Persistent Logging</i> function is disabled. |

■ Configuration

| Parameters | Meaning |
|------------------------|--|
| Max. file size [kbyte] | Specifies the maximum size of the log file in KBytes. If the log file attains the specified size, the device archives this file and saves the following log entries in a newly created file. Possible values: <ul style="list-style-type: none">▶ 0..4096 (default setting: 1024) The value 0 deactivates saving of log entries in the log file. |
| Files (max.) | Specifies the number of log files that the device keeps on the external memory. As soon as the specified maximum number of files has been attained, the device deletes the oldest file and renames the remaining files. Possible values: <ul style="list-style-type: none">▶ 0..25 (default setting: 4) The value 0 deactivates saving of log entries in the log file. |
| Severity | Specifies the minimum severity of the events. The device saves the log entry for events with this severity and with more urgent severities in the log file on the external memory. Possible values: <ul style="list-style-type: none">▶ emergency▶ alert▶ critical▶ error▶ warning (default setting)▶ notice▶ informational▶ debug |

| Parameters | Meaning |
|-----------------|---|
| Log file target | Specifies the external memory device for logging. Possible values: ▶ usb External USB memory (ACA21/ACA22) |

■ Table

| Parameters | Meaning |
|------------------|---|
| Index | Displays the index number to which the table entry relates. Possible values: ▶ 1..25 The device automatically assigns this number. |
| File name | Displays the file name of the log file on the external memory. Possible values: ▶ messages ▶ messages.X |
| File size [byte] | Displays the size of the log file on the external memory in bytes. |

■ Buttons

You find the description of the standard buttons in section [“Buttons” on page 18](#).

| Button | Meaning |
|---|---|
|  | Displays a sub menu with the following items. |
| Delete persistent log file | Removes the log files from the external memory. |

6.6.3 System Log

The device logs important device-internal events in a log file (System Log).

This dialog displays the log file (System Log). The dialog allows you to save the log file in HTML format on your PC.

In order to search the log file for search terms, use the search function of your web browser.

The log file is kept until a restart is performed on the device. After the restart the device creates the file again.

■ Buttons

You find the description of the standard buttons in section [“Buttons” on page 18](#).

| Button | Meaning |
|---|--|
|  | Displays a sub menu with the following items. |
| Save log file | Opens the HTML page in a new web browser window or tab. You can save the HTML page on your PC using the appropriate web browser command. |
| Delete log file | Removes the logged events from the log file. |

6.6.4 Audit Trail

This dialog displays the log file (Audit Trail). The dialog allows you to save the log file as an HTML file on your PC.

In order to search the log file for search terms, use the search function of your web browser.

The device logs system events and writing user actions on the device. This gives you the option of following WHO changes WHAT on the device WHEN. The prerequisite is that the user role `auditor` or `administrator` is assigned to your user account.

The device logs the following user actions, among others:

- ▶ A user logging on via CLI (local or remote)
- ▶ A user logging off manually
- ▶ Automatic logging off of a user in CLI after a specified period of inactivity
- ▶ Device restart
- ▶ Locking of a user account due to too many failed logon attempts
- ▶ Locking of the management access due to failed logon attempts
- ▶ Commands executed in CLI, apart from show commands
- ▶ Changes to configuration variables
- ▶ Changes to the system time
- ▶ File transfer operations, including firmware updates
- ▶ Configuration changes via HiDiscovery
- ▶ Firmware updates and automatic configuration of the device via the external memory
- ▶ Opening and closing of SNMP via an HTTPS tunnel

The device does not log passwords. The logged entries are write-protected and remain saved in the device after a restart.

Note: During the restart, access to the system monitor is possible using the default settings of the device. When an attacker gains physical access to the device, they are able to reset the device settings to its default values using the system monitor. After this, the device and log file are accessible using the standard password. Take appropriate measures to restrict physical access to the device. Otherwise, deactivate access to the system monitor. See the *Diagnostics > System > Selftest* dialog, *SysMon1 is available* checkbox.

■ Buttons

You find the description of the standard buttons in section “Buttons” on page 18.

| Button | Meaning |
|---|--|
|  | Displays a sub menu with the following items. |
| Save audit trail file | Opens the HTML page in a new web browser window or tab. You can save the HTML page on your PC using the appropriate web browser command. |

7 Advanced

The menu contains the following dialogs:

- ▶ [DHCP Server](#)
- ▶ [Industrial Protocols](#)

7.1 DHCP Server

With the DHCP server, you manage a database of available IP addresses and configuration information. When the device receives a request from a client, the DHCP server validates the DHCP client network, and then leases an IP address. When activated, the DHCP server also allocates configuration information appropriate for that client. The configuration information specifies, for example, which IP address, DNS server and the default route a client uses.

The DHCP server assigns an IP address to a client for a user-defined interval. The DHCP client is responsible for renewing the IP address before the interval expires. If the DHCP client is unable to renew the address then the address returns to the pool for reassignment.

The menu contains the following dialogs:

- ▶ [DHCP Server Global](#)
- ▶ [DHCP Server Pool](#)
- ▶ [DHCP Server Lease Table](#)

7.1.1 DHCP Server Global

Activate the function either globally or per port according to your requirements.

■ Operation

| Parameters | Meaning |
|------------|---|
| Operation | Enables/disables the DHCP server function of the device globally. Possible values: <ul style="list-style-type: none"> ▶ On ▶ Off (default setting) |

■ Table

| Parameters | Meaning |
|--------------------|---|
| Port | Displays the port number. |
| DHCP server active | Activates/deactivates the DHCP server function on this port. The prerequisite is that you enable the function globally. Possible values: <ul style="list-style-type: none"> ▶ marked (default setting) The DHCP server function is active. ▶ unmarked The DHCP server function is inactive. |

■ Buttons

You find the description of the standard buttons in section [“Buttons” on page 18](#).

7.1.2 DHCP Server Pool

Assign an IP address to an end device or switch connected to a port or included in a VLAN.

The DHCP server provides IP address pools from which it allocates IP addresses to clients. A pool consists of a list of entries. Specify an entry as static to a specific IP address, or as dynamic to an IP address range. The device accommodates up to 128 pools.

With static allocation, the DHCP server assigns an IP address to a specific client. The DHCP server identifies the client using a unique hardware ID. A static address entry contains 1 IP address. You apply this IP address to every port or to a specific port of the device. For static allocation, enter an IP address for allocation in the *IP address* field, and leave the *Last IP address* column empty. Enter a hardware ID with which the DHCP server uniquely identifies the client. This ID is either a MAC address, a Client ID, a Remote ID, or a Circuit ID. If a client contacts the device with a known hardware ID, the DHCP server allocates the static IP address.

In dynamic allocation, if a DHCP client makes contact on a port, the DHCP server assigns an available IP address from a pool for this port. For dynamic allocation, create a pool for the ports by assigning an IP address range. Specify the first and last IP addresses for the IP address range. Leave the *MAC address*, *Client ID*, *Remote ID* and *Circuit ID* fields empty. You have the option of creating multiple pool entries. This allows you to create an IP address range that contains gaps.

This dialog displays the different information that is required for the assignment of an IP address for a port or a VLAN. Use the  button to add an entry. The device adds a writable and readable entry.

■ Table

| Parameters | Meaning |
|-----------------|--|
| Index | Displays the index number to which the table entry relates. |
| Active | Activates/deactivates the DHCP server function on this port. Possible values: <ul style="list-style-type: none">▶ <i>marked</i> The DHCP server function is active.▶ <i>unmarked</i> (default setting) The DHCP server function is inactive. |
| IP address | Specifies the IP address for static IP address assignment. When using dynamic IP address assignment, this value specifies the start of the IP address range. Possible values: <ul style="list-style-type: none">▶ Valid IPv4 address |
| Last IP address | Specifies the end of the IP address range when using dynamic IP address assignment. Possible values: <ul style="list-style-type: none">▶ Valid IPv4 address |
| Port | Displays the port number. |
| VLAN ID | Displays the VLAN to which the table entry relates. A value of 1 corresponds to the default management VLAN. Possible values: <ul style="list-style-type: none">▶ 1..4042 |

| Parameters | Meaning |
|-------------------|--|
| MAC address | <p>Specifies the MAC address of the device leasing the IP address.</p> <p>Possible values:</p> <ul style="list-style-type: none"> ▶ Valid Unicast MAC address Specify the value in one of the following formats: <ul style="list-style-type: none"> – without a separator, for example 001122334455 – separated by spaces, for example 00 11 22 33 44 55 – separated by colons, for example 00:11:22:33:44:55 – separated by hyphens, for example 00-11-22-33-44-55 – separated by points, for example 00.11.22.33.44.55 – separated by points after every 4th character, for example 0011.2233.4455 ▶ - For the IP address assignment, the server ignores this variable. |
| DHCP relay | <p>Specifies the IP address of the DHCP relay through which the clients transmit their requests to the DHCP server. If the DHCP server receives the client's request through another DHCP relay, it ignores this request.</p> <p>Possible values:</p> <ul style="list-style-type: none"> ▶ Valid IPv4 address IP address of the DHCP relay. ▶ - Between the client and the DHCP server there is no DHCP relay. |
| Client ID | <p>Specifies the identification of the client device leasing the IP address.</p> <p>Possible values:</p> <ul style="list-style-type: none"> ▶ 1..80 bytes (format XX XX .. XX) ▶ - For the IP address assignment, the server ignores this variable. |
| Remote ID | <p>Specifies the identification of the remote device leasing the IP address.</p> <p>Possible values:</p> <ul style="list-style-type: none"> ▶ 1..80 bytes (format XX XX .. XX) ▶ - For the IP address assignment, the server ignores this variable. |
| Circuit ID | <p>Specifies the Circuit ID of the device leasing the IP address.</p> <p>Possible values:</p> <ul style="list-style-type: none"> ▶ 1..80 bytes (format XX XX .. XX) ▶ - For the IP address assignment, the server ignores this variable. |
| Hirschmann device | <p>Activates/deactivates Hirschmann multicasts. Activate this function if the device in this IP address range serves only Hirschmann devices.</p> <p>Possible values:</p> <ul style="list-style-type: none"> ▶ marked In this IP address range, the device serves only Hirschmann devices. Hirschmann multicasts are activated. ▶ unmarked (default setting) In this IP address range, the device serves the devices of different manufacturers. Hirschmann multicasts are deactivated. |
| Configuration URL | <p>Specifies the protocol to be used as well as the name and path of the configuration file.</p> <p>Possible values:</p> <ul style="list-style-type: none"> ▶ Alphanumeric ASCII character string with 0..70 characters Example: tftp://192.9.200.1/cfg/config.sav <p>If you leave this field blank, the device leaves this option field blank in the DHCP message.</p> |
| Lease time [s] | <p>Specifies the lease time in seconds.</p> <p>Possible values:</p> <ul style="list-style-type: none"> ▶ 1..4294967294 (default setting: 86400) ▶ 4294967295 Use this value for assignments unlimited in time and for assignments via BOOTP. |
| Default gateway | <p>Specifies the IP address of the default gateway. A value of 0.0.0.0 disables the attachment of the option field in the DHCP message.</p> <p>Possible values:</p> <ul style="list-style-type: none"> ▶ Valid IPv4 address |

| Parameters | Meaning |
|-------------|---|
| Netmask | Specifies the mask of the network to which the client belongs. A value of 0.0.0.0 disables the attachment of the option field in the DHCP message. Possible values: ▶ Valid IPv4 netmask |
| WINS server | Specifies the IP address of the Windows Internet Name Server which converts NetBIOS names. A value of 0.0.0.0 disables the attachment of the option field in the DHCP message. Possible values: ▶ Valid IPv4 address |
| DNS server | Specifies the IP address of the DNS server. A value of 0.0.0.0 disables the attachment of the option field in the DHCP message. Possible values: ▶ Valid IPv4 address |
| Hostname | Specifies the hostname. If you leave this field blank, the device leaves this option field blank in the DHCP message. Possible values: ▶ Alphanumeric ASCII character string with 0..64 characters |

■ Buttons

You find the description of the standard buttons in section [“Buttons” on page 18](#).

7.1.3 DHCP Server Lease Table

This dialog displays the status of IP address leasing on a per port basis.

■ Table

| Parameters | Meaning |
|--------------------|--|
| Port | Displays the port number to which the address is currently being leased. |
| IP address | Displays the leased IP address to which the entry refers. |
| Status | <p>Displays the lease phase. According to the standard for DHCP operations, there are 4 phases to leasing an IP address: Discovery, Offer, Request, and Acknowledgement.</p> <p>Possible values:</p> <ul style="list-style-type: none"> ▶ bootp A DHCP client is attempting to discover a DHCP server for IP address allocation. ▶ offering The DHCP server is validating that the IP address is suitable for the client. ▶ requesting A DHCP client is acquiring the offered IP address. ▶ bound The DHCP server is leasing the IP address to a client. ▶ renewing The DHCP client is requesting an extension to the lease. ▶ rebinding The DHCP server is assigning the IP address to the client after a successful renewal. ▶ declined The DHCP server denied the request for the IP address. ▶ released The IP address is available for other clients. |
| Remaining lifetime | Displays the time remaining on the leased IP address. |
| Leased MAC address | Displays the MAC address of the device leasing the IP address. |
| Gateway | Displays the Gateway IP address of the device leasing the IP address. |
| Client ID | Displays the client identifier of the device leasing the IP address. |
| Remote ID | Displays the remote identifier of the device leasing the IP address. |
| Circuit ID | Displays the Circuit ID of the device leasing the IP address. |

■ Buttons

You find the description of the standard buttons in section [“Buttons” on page 18](#).

7.2 Industrial Protocols

The menu contains the following dialogs:

- ▶ [IEC61850-MMS](#)
- ▶ [Modbus TCP](#)
- ▶ [EtherNet/IP](#)
- ▶ [PROFINET](#)

7.2.1 IEC61850-MMS

The IEC61850-MMS is a standardized industrial communication protocol from the International Electrotechnical Commission (IEC). For example, automatic switching equipment uses this protocol when communicating with power station equipment.

The packet orientated protocol defines a uniform communication language based on the transport protocol, TCP/IP. The protocol uses a Manufacturing Message Specification (MMS) server for client server communications. The protocol includes functions for SCADA, Intelligent Electronic Device (IED) and the network control systems.

Note: IEC61850/MMS does not provide any authentication mechanisms. If the write access for IEC61850/MMS is activated, every client that can access the device using TCP/IP is capable of changing the settings of the device. This in turn can result in an incorrect configuration of the device and to failures in the network.

Activate the write access exclusively if you have taken additional measures (for example Firewall, VPN, etc.) to reduce the risk of unauthorized access.

This dialog allows you to specify the following MMS server settings:

- ▶ Activates/deactivates the MMS server.
- ▶ Activates/deactivates the write access to the MMS server.
- ▶ The MMS server TCP Port.
- ▶ The maximum number of MMS server sessions.

■ Operation

| Parameters | Meaning |
|------------|---|
| Operation | <p>Enables/disables the <i>IEC61850-MMS</i> server.</p> <p>Possible values:</p> <ul style="list-style-type: none"> ▶ On The <i>IEC61850-MMS</i> server is enabled. ▶ Off (default setting) The <i>IEC61850-MMS</i> server is disabled. The IEC61850 MIBs stay accessible. |

■ Configuration

| Parameters | Meaning |
|--------------|--|
| Write access | <p>Activates/deactivates the write access to the MMS server.</p> <p>Possible values:</p> <ul style="list-style-type: none"> ▶ <i>marked</i> The write access to the MMS server is activated. This setting allows you to change the device settings using the IEC 61850 MMS protocol. ▶ <i>unmarked</i> (default setting) The write access to the MMS server is deactivated. The MMS server is accessible as read-only. |

| Parameters | Meaning |
|-----------------|---|
| Technical key | <p>Specifies the IED name. The IED name is eligible independently of the system name.</p> <p>Possible values:</p> <ul style="list-style-type: none"> ▶ Alphanumeric ASCII character string with 0..32 characters The following characters are allowed: <ul style="list-style-type: none"> - - 0..9 - a..z - A..Z (default setting: KEY) <p>To get the MMS server to use the IED name, click the <input checked="" type="checkbox"/> button and restart the MMS server. The connection to connected clients is then interrupted.</p> |
| TCP port | <p>Specifies TCP port for MMS server access.</p> <p>Possible values:</p> <ul style="list-style-type: none"> ▶ 1..65535 (default setting: 102) Exception: Port 2222 is reserved for internal functions. <p>Note: The server restarts automatically after you change the port. In the process, the device terminates open connections to the server.</p> |
| Sessions (max.) | <p>Specifies the maximum number of MMS server connections.</p> <p>Possible values:</p> <ul style="list-style-type: none"> ▶ 1..15 (default setting: 5) |

■ Information

| Parameters | Meaning |
|------------|--|
| Status | <p>Displays the current <i>IEC61850-MMS</i> server status.</p> <p>Possible values:</p> <ul style="list-style-type: none"> ▶ unavailable ▶ starting ▶ running ▶ stopping ▶ halted ▶ error |

■ Buttons

You find the description of the standard buttons in section [“Buttons” on page 18](#).

| Button | Meaning |
|---|---|
|  | Displays a sub menu with the following items. |
| Download | Copies the ICD file to your PC. |

7.2.2 Modbus TCP

Modbus TCP is a protocol used for Supervisory Control and Data Acquisition (SCADA) system integration. *Modbus TCP* is a vendor-neutral protocol used to monitor and control industrial automation equipment such as Programmable Logic Controllers (PLC), sensors and meters.

This dialog allows you to specify the parameters of the protocol. To monitor and control the parameters of the device, you need Human-Machine Interface (HMI) software and the memory mapping table. Refer to the tables located in the Industrial Protocol user manual for the supported objects and memory mapping.

The dialog allows you to enable the function, activate the write access, control which TCP port the Human-Machine Interface (HMI) polls for data. You can also specify the number of sessions allowed to be open at the same time.

Note: Activating the *Modbus TCP* write-access can cause a possible security risk, because the protocol does not authenticate user access.

To help minimize the security risks, specify the IP address range located in the *Device Security > Management Access* dialog. Enter only the IP addresses assigned to your devices before enabling the function. Furthermore, the default setting for monitoring function activation in the *Diagnostics > Status Configuration > Security Status > Global* tab, is active.

■ Operation

| Parameters | Meaning |
|------------|--|
| Operation | Enables/disables the <i>Modbus TCP</i> server on the device. Possible values: ▶ On The <i>Modbus TCP</i> server is enabled. ▶ Off (default setting) The <i>Modbus TCP</i> server is disabled. |

■ Configuration

| Parameters | Meaning |
|--------------|---|
| Write access | Activates/deactivates the write access to the <i>Modbus TCP</i> parameters. Note: Activating the <i>Modbus TCP</i> write-access can cause a possible security risk, because the protocol does not authenticate user access. Possible values: ▶ marked (default setting) The <i>Modbus TCP</i> server read/write access is active. This allows you to change the device configuration using the <i>Modbus TCP</i> protocol. ▶ unmarked The <i>Modbus TCP</i> server read-only access is active. |
| TCP port | Specifies the TCP port number that the <i>Modbus TCP</i> server uses for communication. Possible values: ▶ <TCP Port number> (default setting: 502) Specifying 0 is not allowed. |

| Parameters | Meaning |
|-----------------|--|
| Sessions (max.) | Specifies the maximum number of concurrent sessions that the <i>Modbus TCP</i> server allows. Possible values: ▶ 1..5 (default setting: 5) |

■ Buttons

You find the description of the standard buttons in section [“Buttons” on page 18](#).

7.2.3 PROFINET

This dialog allows you to configure the PROFINET protocol on this device used in conjunction with PROFINET Controllers and PROFINET devices. The device bases the PROFINET function on the Siemens V2.2 PROFINET stack for common Ethernet controllers. The PROFINET protocol implemented in the device conforms to Class B for real time responses according to IEC 61158.

Functions that directly affect the *PROFINET* function require the following default values to be changed. If you have obtained the device as a specially available *PROFINET* variant, these values are already predefined:

| | |
|----------|---|
| PROFINET | <i>Advanced > Industrial Protocols > PROFINET</i> dialog – <i>Operation</i> frame <i>Operation</i> = On – <i>Configuration</i> frame <i>Name of station</i> field = <empty> |
| Network | <i>Basic Settings > Network</i> dialog – <i>Management interface</i> frame <i>IP address assignment</i> radio button = Local – <i>HiDiscovery protocol v1/v2</i> frame <i>Access</i> drop-down list = readOnly – <i>IP parameter</i> frame <i>IP address</i> field = 0.0.0.0 <i>Netmask</i> field = 0.0.0.0 <i>Gateway address</i> field = 0.0.0.0 |
| VLAN | <i>Switching > Global</i> dialog – <i>Configuration</i> frame <i>VLAN unaware mode</i> checkbox = marked |
| LLDP | <i>Diagnostics > LLDP > Configuration</i> dialog – <i>Configuration</i> frame <i>Transmit interval [s]</i> field = 5 <i>Transmit delay [s]</i> field = 1 |

■ Operation

| Parameters | Meaning |
|------------|---|
| Operation | Enables/disables the PROFINET function on the device. Possible values: ▶ On The PROFINET function is enabled. ▶ Off (default setting) The PROFINET function is disabled. |

■ Configuration

| Parameters | Meaning |
|-----------------|---|
| Name of station | Specifies the name of the device. Possible values: ▶ Alphanumeric ASCII character string with 0..240 characters The device prohibits you from using a number as the first character. |

Information

| Parameters | Meaning |
|------------------------------|---|
| Active application relations | Displays how many application relations are active. |

Table

| Parameters | Meaning |
|------------|--|
| Port | Displays the port number. |
| DCP mode | <p>Specifies the data stream direction on the port to monitor for DCP packets.</p> <p>The Programmable Logic Controller (PLC) detects PROFINET devices using the Discovery and Configuration Protocol (DCP).</p> <p>The DCP identify request packets are multicast, the responses from the agents are unicast. Regardless of the settings, the device forwards the received DCP packets to other ports whose setting is either <i>egress</i> or <i>both</i>.</p> |

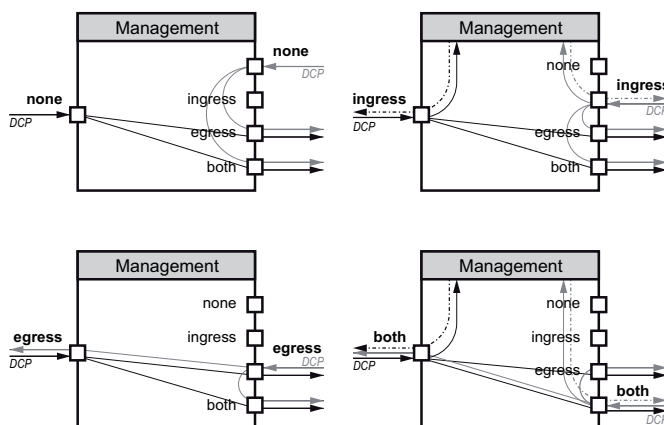

Possible values:

- ▶ *none*
The agent does not respond to packets received on this port. The port does not forward packets received on other ports.
- ▶ *ingress*
The agent responds to packets received on this port. The port does not forward packets received on other ports.
- ▶ *egress*
The agent does not respond to packets received on this port. The port forwards packets received on other ports.
- ▶ *both* (default setting)
The agent responds to packets received on this port. The port forwards packets received on other ports.

Buttons

You find the description of the standard buttons in section [“Buttons” on page 18](#).

| Parameters | Meaning |
|---|---|
|  | Displays a sub menu with the following items. |
| Download GSDML file | Copies the GSDML file onto your PC. |

7.2.4 EtherNet/IP

This dialog allows you to activate the *EtherNet/IP* protocol, to change the SET/GET capability and to download the EDS file from the device.

■ Operation

| Parameters | Meaning |
|------------|--|
| Operation | <p>Enables/disables the <i>EtherNet/IP</i> function on the device.</p> <p>Possible values:</p> <ul style="list-style-type: none"> ▶ On The <i>EtherNet/IP</i> function is enabled. ▶ Off (default setting) The <i>EtherNet/IP</i> function is disabled. The device continues to read the EtherNet/IP data. |

■ Configuration

| Parameters | Meaning |
|--------------|--|
| Write access | <p>Activates/deactivates the read/write capability of the <i>EtherNet/IP</i> protocol.</p> <p>Possible values:</p> <ul style="list-style-type: none"> ▶ marked The <i>EtherNet/IP</i> protocol allows set/get requests. ▶ unmarked (default setting) The <i>EtherNet/IP</i> protocol allows only get requests. |

■ Buttons

You find the description of the standard buttons in section [“Buttons” on page 18](#).

| Button | Meaning |
|---|--|
|  | Displays a sub menu with the following items. |
| Download EDS file | <p>Copies the following information in a zip file onto your PC:</p> <ul style="list-style-type: none"> ▶ Electronic Data Sheet (EDS) with device related information ▶ device icon |

A Index

| | | |
|-------------------------------------|------------------------------------|--|
| 1 | | |
| 802.1D/p mapping | 172 | |
| 802.1X | 84, 117 | |
| A | | |
| Access control | 117 | |
| Access restriction | 101 | |
| Address conflict detection | 258 | |
| Aging time | 140, 261 | |
| Alarms | 252 | |
| ARP | 258 | |
| ARP table | 261 | |
| Audit trail | 299 | |
| Authentication history | 125 | |
| Authentication list | 84 | |
| Auto disable | 112, 212, 270, 271, 271, 278 | |
| B | | |
| Boundary clock | 66 | |
| Bridge | 210 | |
| C | | |
| Certificate | 21, 37, 99, 100, 240 | |
| CLI | 105 | |
| Command line interface | 105 | |
| Community names | 108 | |
| Configuration check | 256 | |
| Configuration profile | 17, 29 | |
| Context menu | 16 | |
| Counter reset | 49 | |
| D | | |
| Daylight saving time | 54 | |
| Device software | 27 | |
| Device software backup | 27 | |
| Device status | 20, 231 | |
| DHCP server | 302 | |
| DLR | 187 | |
| DoS | 135 | |
| DSCP | 173 | |
| E | | |
| EAPOL | 124 | |
| Egress rate limiter | 142 | |
| Encryption | 29 | |
| ENVM | 28, 29, 33, 38, 233, 239, 246, 297 | |
| EtherNet/IP | 240, 315 | |
| Event severity | 295 | |
| External memory | 28, 29, 33, 38, 297 | |
| F | | |
| Fast\ MRP | 184, 185 | |
| FAQ | 319 | |
| FDB | 144 | |
| Filter MAC addresses | 144 | |
| Fingerprint | 95, 98 | |
| Flash memory | 28, 255 | |
| Flow control | 140 | |
| Forwarding database | 144 | |
| G | | |
| Guards | 219 | |
| H | | |
| Hardware clock | 52 | |
| Hardware state | 255 | |
| HiDiscovery | 24, 25, 91, 239, 299 | |
| Host key | 96 | |
| HSR | 202 | |
| HTML | 254, 298 | |
| HTTP | 97 | |
| HTTPS | 98 | |
| HTTP server | 238 | |
| I | | |
| IAS | 84, 127 | |
| IEC61850-MMS | 240, 309 | |
| IEEE 802.1X | 84 | |
| IGMP snooping | 146 | |
| Industrial HiVision | 11, 91 | |
| Ingress filtering | 180 | |
| Ingress rate limiter | 142 | |
| Integrated authentication server | 84, 127 | |
| IP access restriction | 101 | |
| IP address conflict detection | 258 | |
| IP DSCP mapping | 173 | |
| L | | |
| Link aggregation | 221 | |
| Link backup | 226 | |
| LLDP | 284 | |
| Load/save | 29 | |
| Login banner | 107, 109 | |
| Log file | 49, 298 | |
| Loops | 209 | |
| M | | |
| Management access | 24, 101 | |
| Management VLAN | 24 | |
| Manufacturing message specification | 309 | |
| MAC address table | 144 | |
| MAC flood | 112 | |
| MAC spoof | 112 | |
| Media redundancy protocol | 184 | |
| Menu | 16 | |
| MMRP | 160 | |
| MMS | 309 | |
| Modbus TCP | 240, 311 | |
| MRP | 184 | |
| MRP-IEEE | 158 | |
| MVRP | 165 | |
| N | | |
| Network load | 48 | |
| NVM | 16, 17, 22, 28, 33 | |
| P | | |
| Parallel redundancy protocol | 195 | |
| Password | 80, 237, 238 | |
| Password length | 80, 237 | |

| | | | |
|-------------------------------|---|----------------------------|---|
| Persistent logging | 296 | Transparent clock | 73 |
| Port clients | 123 | Traps | 44, 113, 210, 222, 232, 237, 246, 252, 260, 270 |
| Port configuration | 120, 171 | Trap destination | 252 |
| Port mirroring | 281 | Trust mode | 171 |
| Port monitor | 278 | U | |
| Port priority | 171 | Unaware mode | 140 |
| Port security | 112 | User administration | 80 |
| Port statistics | 124 | Utilization | 48 |
| Port VLAN | 180 | V | |
| Port-based access control | 117 | Virtual local area network | 176 |
| Power supply | 21, 233, 247 | VLAN | 24, 176 |
| Pre-Login banner | 109 | VLAN configuration | 178 |
| Priority queue | 170 | VLAN ports | 180 |
| PROFINET | 240, 313 | VLAN unaware mode | 140 |
| PRP | 195 | V.24 | 239 |
| Q | | W | |
| Queues | 170 | Watchdog | 29, 32 |
| Queue management | 175 | Web server | 97, 98 |
| R | | Z | |
| Rate limiter | 142 | ZIP archive | 294 |
| RADIUS | 84, 128 | | |
| RAM | 33 | | |
| RAM test | 262 | | |
| Reboot | 49 | | |
| Request interval | 58 | | |
| Ring structure | 184 | | |
| Root bridge | 210 | | |
| RSTP | 209, 210 | | |
| S | | | |
| Secure shell | 94 | | |
| Security status | 20, 236 | | |
| Self-test | 262 | | |
| Settings | 29 | | |
| Severity | 295 | | |
| SFP module | 267 | | |
| Signal contact | 21, 243 | | |
| Signature | 95 | | |
| SNMPv1/v2 | 108 | | |
| SNMP server | 91, 238 | | |
| SNMP traps | 44, 113, 210, 222, 232, 237, 246, 252, 260, 270 | | |
| SNTP | 57 | | |
| SNTP client | 58 | | |
| SNTP server | 61 | | |
| Software backup | 27 | | |
| Software update | 27 | | |
| Spanning tree protocol | 209 | | |
| SSH server | 94 | | |
| Switch dump | 294 | | |
| Syslog | 264 | | |
| System information | 254 | | |
| System log | 298 | | |
| System monitor | 262 | | |
| System time | 53 | | |
| T | | | |
| Technical questions | 319 | | |
| Telnet server | 93, 238 | | |
| Temperature | 22, 232, 246 | | |
| Threshold values network load | 142 | | |
| Topology discovery | 288 | | |
| Training courses | 319 | | |

B Further support

Technical questions

For technical questions, please contact any Hirschmann dealer in your area or Hirschmann directly.

You find the addresses of our partners on the Internet at <http://www.hirschmann.com>.

A list of local telephone numbers and email addresses for technical support directly from Hirschmann is available at <https://hirschmann-support.belden.eu.com>.

This site also includes a free of charge knowledge base and a software download section.

Hirschmann Competence Center

The Hirschmann Competence Center is ahead of its competitors on three counts with its complete range of innovative services:

- ▶ Consulting incorporates comprehensive technical advice, from system evaluation through network planning to project planning.
- ▶ Training offers you an introduction to the basics, product briefing and user training with certification. You find the training courses on technology and products currently available at <http://www.hicomcenter.com>.
- ▶ Support ranges from the first installation through the standby service to maintenance concepts.

With the Hirschmann Competence Center, you decided against making any compromises. Our client-customized package leaves you free to choose the service components you want to use.

Internet:

<http://www.hicomcenter.com>

C Readers' Comments

What is your opinion of this manual? We are constantly striving to provide as comprehensive a description of our product as possible, as well as important information to assist you in the operation of this product. Your comments and suggestions help us to further improve the quality of our documentation.

Your assessment of this manual:

| | Very Good | Good | Satisfactory | Mediocre | Poor |
|---------------------|-----------------------|-----------------------|-----------------------|-----------------------|-----------------------|
| Precise description | <input type="radio"/> | <input type="radio"/> | <input type="radio"/> | <input type="radio"/> | <input type="radio"/> |
| Readability | <input type="radio"/> | <input type="radio"/> | <input type="radio"/> | <input type="radio"/> | <input type="radio"/> |
| Understandability | <input type="radio"/> | <input type="radio"/> | <input type="radio"/> | <input type="radio"/> | <input type="radio"/> |
| Examples | <input type="radio"/> | <input type="radio"/> | <input type="radio"/> | <input type="radio"/> | <input type="radio"/> |
| Structure | <input type="radio"/> | <input type="radio"/> | <input type="radio"/> | <input type="radio"/> | <input type="radio"/> |
| Comprehensive | <input type="radio"/> | <input type="radio"/> | <input type="radio"/> | <input type="radio"/> | <input type="radio"/> |
| Graphics | <input type="radio"/> | <input type="radio"/> | <input type="radio"/> | <input type="radio"/> | <input type="radio"/> |
| Drawings | <input type="radio"/> | <input type="radio"/> | <input type="radio"/> | <input type="radio"/> | <input type="radio"/> |
| Tables | <input type="radio"/> | <input type="radio"/> | <input type="radio"/> | <input type="radio"/> | <input type="radio"/> |

Did you discover any errors in this manual?
If so, on what page?

Suggestions for improvement and additional information:

General comments:

Sender:

Company / Department:

Name / Telephone number:

Street:

Zip code / City:

E-mail:

Date / Signature:

Dear User,

Please fill out and return this page

- ▶ as a fax to the number +49 (0)7127/14-1600 or
- ▶ per mail to

Hirschmann Automation and Control GmbH
Department 01RD-NT
Stuttgarter Str. 45-51
72654 Neckartenzlingen



HIRSCHMANN

A **BELDEN** BRAND



HIRSCHMANN

A **BELDEN** BRAND

Reference Manual

Command Line Interface HiOS-2S RED (Redundancy Switch)

The naming of copyrighted trademarks in this manual, even when not specially indicated, should not be taken to mean that these names may be considered as free in the sense of the trademark and tradename protection law and hence that they may be freely used by anyone.

© 2016 Hirschmann Automation and Control GmbH

Manuals and software are protected by copyright. All rights reserved. The copying, reproduction, translation, conversion into any electronic medium or machine scannable form is not permitted, either in whole or in part. An exception is the preparation of a backup copy of the software for your own use.

The performance features described here are binding only if they have been expressly agreed when the contract was made. This document was produced by Hirschmann Automation and Control GmbH according to the best of the company's knowledge. Hirschmann reserves the right to change the contents of this document without prior notice. Hirschmann can give no guarantee in respect of the correctness or accuracy of the information in this document.

Hirschmann can accept no responsibility for damages, resulting from the use of the network components or the associated operating software. In addition, we refer to the conditions of use specified in the license contract.

You can get the latest version of this manual on the Internet at the Hirschmann product site (www.hirschmann.com).

Hirschmann Automation and Control GmbH
Stuttgarter Str. 45-51
72654 Neckartenzlingen
Germany

Contents

| | |
|---|-----------|
| Safety instructions | 26 |
| About this Manual | 27 |
| 1 Command reference | 29 |
| 2 Address Conflict Detection (ACD) | 31 |
| 2.1 address-conflict | 32 |
| 2.1.1 address-conflict operation | 32 |
| 2.1.2 address-conflict detection-mode | 32 |
| 2.1.3 address-conflict detection-ongoing | 33 |
| 2.1.4 address-conflict delay | 33 |
| 2.1.5 address-conflict release-delay | 33 |
| 2.1.6 address-conflict max-protection | 34 |
| 2.1.7 address-conflict protect-interval | 34 |
| 2.1.8 address-conflict trap-status | 34 |
| 2.2 show | 35 |
| 2.2.1 show address-conflict global | 35 |
| 2.2.2 show address-conflict detected | 35 |
| 2.2.3 show address-conflict fault-state | 35 |
| 2.2.4 show mac-address-conflict global | 36 |
| 3 Application Lists | 37 |
| 3.1 applists | 38 |
| 3.1.1 applists set-authlist | 38 |
| 3.1.2 applists enable | 38 |
| 3.1.3 applists disable | 38 |
| 3.2 show | 39 |
| 3.2.1 show applists | 39 |
| 4 Authentication Lists | 41 |
| 4.1 authlists | 42 |
| 4.1.1 authlists add | 42 |
| 4.1.2 authlists delete | 42 |
| 4.1.3 authlists set-policy | 42 |
| 4.1.4 authlists enable | 43 |
| 4.1.5 authlists disable | 44 |
| 4.2 show | 45 |
| 4.2.1 show authlists | 45 |
| 5 Auto Disable | 47 |
| 5.1 auto-disable | 48 |
| 5.1.1 auto-disable reason | 48 |
| 5.2 auto-disable | 49 |
| 5.2.1 auto-disable timer | 49 |
| 5.2.2 auto-disable reset | 49 |
| 5.3 show | 50 |
| 5.3.1 show auto-disable brief | 50 |
| 5.3.2 show auto-disable reasons | 50 |
| 6 Class Of Service | 51 |
| 6.1 classofservice | 52 |

| | | |
|----------|-------------------------------------|-----------|
| 6.1.1 | classofservice ip-dscp-mapping | 52 |
| 6.1.2 | classofservice dot1p-mapping | 55 |
| 6.2 | classofservice | 56 |
| 6.2.1 | classofservice trust | 56 |
| 6.3 | cos-queue | 57 |
| 6.3.1 | cos-queue strict | 57 |
| 6.3.2 | cos-queue weighted | 57 |
| 6.3.3 | cos-queue min-bandwidth | 57 |
| 6.4 | show | 59 |
| 6.4.1 | show classofservice ip-dscp-mapping | 59 |
| 6.4.2 | show classofservice dot1p-mapping | 59 |
| 6.4.3 | show classofservice trust | 59 |
| 6.4.4 | show cos-queue | 60 |
| 7 | Command Line Interface (CLI) | 61 |
| 7.1 | cli | 62 |
| 7.1.1 | cli serial-timeout | 62 |
| 7.1.2 | cli prompt | 62 |
| 7.1.3 | cli numlines | 63 |
| 7.1.4 | cli banner operation | 63 |
| 7.1.5 | cli banner text | 63 |
| 7.2 | show | 64 |
| 7.2.1 | show cli global | 64 |
| 7.2.2 | show cli command-tree | 64 |
| 7.3 | logging | 65 |
| 7.3.1 | logging cli-command | 65 |
| 7.4 | show | 66 |
| 7.4.1 | show logging cli-command | 66 |
| 8 | Clock | 67 |
| 8.1 | clock | 68 |
| 8.1.1 | clock set | 68 |
| 8.1.2 | clock timezone offset | 68 |
| 8.1.3 | clock timezone zone | 68 |
| 8.1.4 | clock summer-time mode | 69 |
| 8.1.5 | clock summer-time recurring start | 69 |
| 8.1.6 | clock summer-time recurring end | 70 |
| 8.1.7 | clock summer-time zone | 70 |
| 8.2 | show | 71 |
| 8.2.1 | show clock | 71 |
| 9 | Configuration | 73 |
| 9.1 | save | 74 |
| 9.1.1 | save profile | 74 |
| 9.2 | config | 75 |
| 9.2.1 | config watchdog admin-state | 75 |
| 9.2.2 | config watchdog timeout | 75 |
| 9.2.3 | config encryption password set | 76 |
| 9.2.4 | config encryption password clear | 76 |
| 9.2.5 | config envm auto-update | 76 |
| 9.2.6 | config envm sshkey-auto-update | 77 |
| 9.2.7 | config envm config-save | 77 |
| 9.2.8 | config envm load-priority | 78 |
| 9.2.9 | config envm usb-compatibility | 78 |
| 9.2.10 | config profile select | 78 |
| 9.2.11 | config profile delete | 79 |
| 9.2.12 | config fingerprint verify | 79 |

| | | |
|-----------|--|-----------|
| 9.3 | copy | 80 |
| 9.3.1 | copy sysinfo system envm | 80 |
| 9.3.2 | copy sysinfoall system envm | 80 |
| 9.3.3 | copy firmware envm | 80 |
| 9.3.4 | copy firmware remote | 81 |
| 9.3.5 | copy config running-config nvm | 81 |
| 9.3.6 | copy config running-config remote | 81 |
| 9.3.7 | copy config nvm | 82 |
| 9.3.8 | copy config envm | 82 |
| 9.3.9 | copy config remote | 82 |
| 9.3.10 | copy sfp-white-list remote | 83 |
| 9.3.11 | copy sfp-white-list envm | 83 |
| 9.4 | clear | 84 |
| 9.4.1 | clear config | 84 |
| 9.4.2 | clear factory | 84 |
| 9.4.3 | clear sfp-white-list | 84 |
| 9.5 | show | 85 |
| 9.5.1 | show running-config xml | 85 |
| 9.5.2 | show running-config script | 85 |
| 9.6 | show | 86 |
| 9.6.1 | show config envm settings | 86 |
| 9.6.2 | show config envm properties | 86 |
| 9.6.3 | show config envm usb-compatibility | 86 |
| 9.6.4 | show config watchdog | 87 |
| 9.6.5 | show config encryption | 87 |
| 9.6.6 | show config profiles | 87 |
| 9.6.7 | show config status | 87 |
| 9.7 | swap | 88 |
| 9.7.1 | swap firmware system backup | 88 |
| 10 | Debugging | 89 |
| 10.1 | debug | 90 |
| 10.1.1 | debug tcpdump help | 90 |
| 10.1.2 | debug tcpdump start cpu | 90 |
| 10.1.3 | debug tcpdump stop | 90 |
| 10.1.4 | debug tcpdump filter show | 91 |
| 10.1.5 | debug tcpdump filter list | 91 |
| 10.1.6 | debug tcpdump filter delete | 91 |
| 10.2 | show | 92 |
| 10.2.1 | show debug logic-modules | 92 |
| 10.3 | copy | 93 |
| 10.3.1 | copy tcpdumpcap nvm envm | 93 |
| 10.3.2 | copy tcpdumpcap nvm remote | 93 |
| 10.3.3 | copy tcpdumpfilter remote | 93 |
| 10.3.4 | copy tcpdumpfilter envm | 94 |
| 10.3.5 | copy tcpdumpfilter nvm | 94 |
| 11 | Device Monitoring | 95 |
| 11.1 | device-status | 96 |
| 11.1.1 | device-status monitor link-failure | 96 |
| 11.1.2 | device-status monitor temperature | 96 |
| 11.1.3 | device-status monitor envm-removal | 97 |
| 11.1.4 | device-status monitor envm-not-in-sync | 97 |
| 11.1.5 | device-status monitor ring-redundancy | 97 |
| 11.1.6 | device-status monitor power-supply | 98 |
| 11.1.7 | device-status trap | 98 |
| 11.2 | device-status | 99 |
| 11.2.1 | device-status link-alarm | 99 |

| | | |
|-----------|---|------------|
| 11.3 | show | 100 |
| 11.3.1 | show device-status monitor | 100 |
| 11.3.2 | show device-status state | 100 |
| 11.3.3 | show device-status trap | 100 |
| 11.3.4 | show device-status events | 101 |
| 11.3.5 | show device-status link-alarm | 101 |
| 11.3.6 | show device-status all | 101 |
| 12 | Device Security | 103 |
| 12.1 | security-status | 104 |
| 12.1.1 | security-status monitor pwd-change | 104 |
| 12.1.2 | security-status monitor pwd-min-length | 104 |
| 12.1.3 | security-status monitor pwd-policy-config | 105 |
| 12.1.4 | security-status monitor pwd-str-not-config | 105 |
| 12.1.5 | security-status monitor pwd-policy-inactive | 105 |
| 12.1.6 | security-status monitor bypass-pwd-strength | 106 |
| 12.1.7 | security-status monitor telnet-enabled | 106 |
| 12.1.8 | security-status monitor http-enabled | 107 |
| 12.1.9 | security-status monitor snmp-unsecure | 107 |
| 12.1.10 | security-status monitor sysmon-enabled | 107 |
| 12.1.11 | security-status monitor extnvm-upd-enabled | 108 |
| 12.1.12 | security-status monitor no-link-enabled | 108 |
| 12.1.13 | security-status monitor hidisc-write-enabled | 109 |
| 12.1.14 | security-status monitor extnvm-load-unsecure | 109 |
| 12.1.15 | security-status monitor iec61850-mms-enabled | 109 |
| 12.1.16 | security-status monitor https-certificate | 110 |
| 12.1.17 | security-status monitor modbus-tcp-enabled | 110 |
| 12.1.18 | security-status monitor ethernet-ip-enabled | 111 |
| 12.1.19 | security-status monitor profinet-io-enabled | 111 |
| 12.1.20 | security-status trap | 111 |
| 12.2 | security-status | 113 |
| 12.2.1 | security-status no-link | 113 |
| 12.3 | show | 114 |
| 12.3.1 | show security-status monitor | 114 |
| 12.3.2 | show security-status state | 114 |
| 12.3.3 | show security-status no-link | 114 |
| 12.3.4 | show security-status trap | 115 |
| 12.3.5 | show security-status events | 115 |
| 12.3.6 | show security-status all | 115 |
| 13 | Dynamic Host Configuration Protocol (DHCP) | 117 |
| 13.1 | dhcp-server | 118 |
| 13.1.1 | dhcp-server operation | 118 |
| 13.2 | dhcp-server | 119 |
| 13.2.1 | dhcp-server operation | 119 |
| 13.2.2 | dhcp-server pool add | 119 |
| 13.2.3 | dhcp-server pool modify | 120 |
| 13.2.4 | dhcp-server pool mode | 121 |
| 13.2.5 | dhcp-server pool delete | 121 |
| 13.3 | show | 122 |
| 13.3.1 | show dhcp-server operation | 122 |
| 13.3.2 | show dhcp-server pool | 122 |
| 13.3.3 | show dhcp-server interface | 122 |
| 13.3.4 | show dhcp-server lease | 123 |
| 14 | DHCP Layer 2 Relay | 125 |
| 14.1 | clear | 126 |
| 14.1.1 | clear dhcp-l2relay statistics | 126 |

| | | |
|-----------|--|------------|
| 14.2 | show | 127 |
| | 14.2.1 show dhcp-l2relay global | 127 |
| | 14.2.2 show dhcp-l2relay statistics | 127 |
| | 14.2.3 show dhcp-l2relay interfaces | 127 |
| | 14.2.4 show dhcp-l2relay vlan | 128 |
| 15 | DHCP Snooping | 129 |
| 15.1 | clear | 130 |
| | 15.1.1 clear ip dhcp-snooping bindings | 130 |
| | 15.1.2 clear ip dhcp-snooping statistics | 130 |
| 15.2 | show | 131 |
| | 15.2.1 show ip dhcp-snooping global | 131 |
| | 15.2.2 show ip dhcp-snooping statistics | 131 |
| | 15.2.3 show ip dhcp-snooping interfaces | 131 |
| | 15.2.4 show ip dhcp-snooping vlan | 132 |
| | 15.2.5 show ip dhcp-snooping bindings | 132 |
| 16 | Device Level Ring (DLR) | 133 |
| 16.1 | dlr | 134 |
| | 16.1.1 dlr operation | 134 |
| | 16.1.2 dlr ring add | 134 |
| | 16.1.3 dlr ring delete | 135 |
| | 16.1.4 dlr ring modify | 135 |
| 16.2 | show | 137 |
| | 16.2.1 show dlr global | 137 |
| | 16.2.2 show dlr ring config | 137 |
| | 16.2.3 show dlr ring status | 137 |
| | 16.2.4 show dlr ring participants | 138 |
| | 16.2.5 show dlr gateway config | 138 |
| | 16.2.6 show dlr gateway status | 138 |
| 17 | DoS Mitigation | 139 |
| 17.1 | dos | 140 |
| | 17.1.1 dos tcp-null | 140 |
| | 17.1.2 dos tcp-xmas | 140 |
| | 17.1.3 dos tcp-syn-fin | 141 |
| | 17.1.4 dos tcp-min-header | 141 |
| | 17.1.5 dos icmp-fragmented | 141 |
| | 17.1.6 dos icmp payload-check | 142 |
| | 17.1.7 dos icmp payload-size | 142 |
| | 17.1.8 dos ip-land | 143 |
| | 17.1.9 dos tcp-offset | 143 |
| | 17.1.10 dos tcp-syn | 143 |
| | 17.1.11 dos l4-port | 144 |
| 17.2 | show | 145 |
| | 17.2.1 show dos | 145 |
| 18 | IEEE 802.1x (Dot1x) | 147 |
| 18.1 | dot1x | 148 |
| | 18.1.1 dot1x dynamic-vlan | 148 |
| | 18.1.2 dot1x system-auth-control | 148 |
| | 18.1.3 dot1x monitor | 149 |
| 18.2 | dot1x | 150 |
| | 18.2.1 dot1x guest-vlan | 150 |
| | 18.2.2 dot1x max-req | 150 |
| | 18.2.3 dot1x port-control | 150 |
| | 18.2.4 dot1x re-authentication | 151 |
| | 18.2.5 dot1x unauthenticated-vlan | 151 |

| | |
|---|------------|
| 18.2.6dot1x timeout guest-vlan-period | 152 |
| 18.2.7dot1x timeout reauth-period | 152 |
| 18.2.8dot1x timeout quiet-period | 152 |
| 18.2.9dot1x timeout tx-period | 152 |
| 18.2.10dot1x timeout supp-timeout | 153 |
| 18.2.11dot1x timeout server-timeout | 153 |
| 18.2.12dot1x initialize | 153 |
| 18.2.13dot1x re-authenticate | 154 |
| 18.3 show | 155 |
| 18.3.1show dot1x global | 155 |
| 18.3.2show dot1x auth-history | 155 |
| 18.3.3show dot1x detail | 155 |
| 18.3.4show dot1x summary | 156 |
| 18.3.5show dot1x clients | 156 |
| 18.3.6show dot1x statistics | 156 |
| 18.4 clear | 157 |
| 18.4.1clear dot1x statistics port | 157 |
| 18.4.2clear dot1x statistics all | 157 |
| 18.4.3clear dot1x auth-history port | 157 |
| 18.4.4clear dot1x auth-history all | 158 |
| 19 IEEE 802.3ad (Dot3ad) | 159 |
| 19.1 link-aggregation | 160 |
| 19.1.1link-aggregation add | 160 |
| 19.1.2link-aggregation modify | 160 |
| 19.1.3link-aggregation delete | 161 |
| 19.2 lacp | 162 |
| 19.2.1lacp admin-key | 162 |
| 19.2.2lacp collector-max-delay | 162 |
| 19.2.3lacp lacpmode | 162 |
| 19.2.4lacp actor admin key | 163 |
| 19.2.5lacp actor admin state lacp-activity | 163 |
| 19.2.6lacp actor admin state lacp-timeout | 164 |
| 19.2.7lacp actor admin state aggregation | 164 |
| 19.2.8lacp actor admin port priority | 164 |
| 19.2.9lacp partner admin key | 165 |
| 19.2.10lacp partner admin state lacp-activity | 165 |
| 19.2.11lacp partner admin state lacp-timeout | 165 |
| 19.2.12lacp partner admin state aggregation | 166 |
| 19.2.13lacp partner admin port priority | 166 |
| 19.2.14lacp partner admin port id | 166 |
| 19.2.15lacp partner admin system-priority | 167 |
| 19.2.16lacp partner admin system-id | 167 |
| 19.3 show | 168 |
| 19.3.1show link-aggregation port | 168 |
| 19.3.2show link-aggregation statistics | 168 |
| 19.3.3show link-aggregation members | 168 |
| 19.3.4show lacp interface | 169 |
| 19.3.5show lacp mode | 169 |
| 19.3.6show lacp actor | 169 |
| 19.3.7show lacp partner operational | 169 |
| 19.3.8show lacp partner admin | 170 |
| 20 Ethernet IP | 171 |
| 20.1 ethernet-ip | 172 |
| 20.1.1ethernet-ip operation | 172 |
| 20.1.2ethernet-ip write-access | 172 |
| 20.2 show | 173 |
| 20.2.1show ethernet-ip | 173 |

| | | |
|-----------|--|------------|
| 20.3 | copy | 174 |
| 20.3.1 | copy eds-ethernet-ip system remote | 174 |
| 20.3.2 | copy eds-ethernet-ip system envm | 174 |
| 21 | Filtering Database (FDB) | 175 |
| 21.1 | mac-filter | 176 |
| 21.1.1 | mac-filter | 176 |
| 21.2 | bridge | 177 |
| 21.2.1 | bridge aging-time | 177 |
| 21.3 | show | 178 |
| 21.3.1 | show mac-filter-table static | 178 |
| 21.4 | show | 179 |
| 21.4.1 | show bridge aging-time | 179 |
| 21.5 | show | 180 |
| 21.5.1 | show mac-addr-table | 180 |
| 21.6 | clear | 181 |
| 21.6.1 | clear mac-addr-table | 181 |
| 22 | HiDiscovery | 183 |
| 22.1 | network | 184 |
| 22.1.1 | network hidiscovery operation | 184 |
| 22.1.2 | network hidiscovery mode | 184 |
| 22.1.3 | network hidiscovery blinking | 185 |
| 22.1.4 | network hidiscovery relay | 185 |
| 22.2 | show | 186 |
| 22.2.1 | show network hidiscovery | 186 |
| 23 | High-availability Seamless Redundancy (HSR) | 187 |
| 23.1 | hsr | 188 |
| 23.1.1 | hsr operation | 188 |
| 23.1.2 | hsr instance | 188 |
| 23.2 | clear | 190 |
| 23.2.1 | clear hsr proxy-node-table | 190 |
| 23.2.2 | clear hsr node-table | 190 |
| 23.2.3 | clear hsr counters | 190 |
| 23.3 | show | 191 |
| 23.3.1 | show hsr global | 191 |
| 23.3.2 | show hsr instance | 191 |
| 23.3.3 | show hsr node-table | 191 |
| 23.3.4 | show hsr proxy-node-table | 192 |
| 23.3.5 | show hsr counters | 192 |
| 24 | Hypertext Transfer Protocol (HTTP) | 193 |
| 24.1 | http | 194 |
| 24.1.1 | http port | 194 |
| 24.1.2 | http server | 194 |
| 24.2 | show | 195 |
| 24.2.1 | show http | 195 |
| 25 | HTTP Secure (HTTPS) | 197 |
| 25.1 | https | 198 |
| 25.1.1 | https server | 198 |
| 25.1.2 | https port | 198 |
| 25.1.3 | https certificate | 199 |

| | | |
|-----------|--|------------|
| 25.2 | copy | 200 |
| | 25.2.1 copy https-cert remote | 200 |
| | 25.2.2 copy https-cert envm | 200 |
| 25.3 | show | 201 |
| | 25.3.1 show https | 201 |
| 26 | Integrated Authentication Server (IAS) | 203 |
| 26.1 | ias-users | 204 |
| | 26.1.1 ias-users add | 204 |
| | 26.1.2 ias-users delete | 204 |
| | 26.1.3 ias-users enable | 204 |
| | 26.1.4 ias-users disable | 205 |
| | 26.1.5 ias-users password | 205 |
| 26.2 | show | 206 |
| | 26.2.1 show ias-users | 206 |
| 27 | IEC 61850 MMS Server | 207 |
| 27.1 | iec61850-mms | 208 |
| | 27.1.1 iec61850-mms operation | 208 |
| | 27.1.2 iec61850-mms write-access | 208 |
| | 27.1.3 iec61850-mms port | 209 |
| | 27.1.4 iec61850-mms max-sessions | 209 |
| | 27.1.5 iec61850-mms technical-key | 209 |
| 27.2 | show | 210 |
| | 27.2.1 show iec61850-mms | 210 |
| 28 | Internet Group Management Protocol (IGMP) | 211 |
| 28.1 | show | 212 |
| | 28.1.1 show ip igmp global | 212 |
| | 28.1.2 show ip igmp interface | 212 |
| | 28.1.3 show ip igmp membership | 212 |
| | 28.1.4 show ip igmp groups | 213 |
| | 28.1.5 show ip igmp statistics | 213 |
| 29 | IGMP Proxy | 215 |
| 29.1 | show | 216 |
| | 29.1.1 show ip igmp-proxy global | 216 |
| | 29.1.2 show ip igmp-proxy groups | 216 |
| | 29.1.3 show ip igmp-proxy source-list | 216 |
| 30 | IGMP Snooping | 217 |
| 30.1 | igmp-snooping | 218 |
| | 30.1.1 igmp-snooping mode | 218 |
| | 30.1.2 igmp-snooping querier mode | 218 |
| | 30.1.3 igmp-snooping querier query-interval | 219 |
| | 30.1.4 igmp-snooping querier timer-expiry | 219 |
| | 30.1.5 igmp-snooping querier version | 219 |
| | 30.1.6 igmp-snooping forward-unknown | 220 |
| 30.2 | igmp-snooping | 221 |
| | 30.2.1 igmp-snooping vlan-id | 221 |
| 30.3 | igmp-snooping | 223 |
| | 30.3.1 igmp-snooping mode | 223 |
| | 30.3.2 igmp-snooping fast-leave | 223 |
| | 30.3.3 igmp-snooping groupmembership-interval | 224 |
| | 30.3.4 igmp-snooping maxresponse | 224 |
| | 30.3.5 igmp-snooping mcrtruntime | 224 |

| | | |
|-----------|---|------------|
| 30.3.6 | igmp-snooping static-query-port | 224 |
| 30.4 | show | 226 |
| 30.4.1 | show igmp-snooping global | 226 |
| 30.4.2 | show igmp-snooping interface | 226 |
| 30.4.3 | show igmp-snooping vlan | 226 |
| 30.4.4 | show igmp-snooping querier global | 227 |
| 30.4.5 | show igmp-snooping querier vlan | 227 |
| 30.4.6 | show igmp-snooping enhancements vlan | 227 |
| 30.4.7 | show igmp-snooping enhancements unknown-filtering | 227 |
| 30.4.8 | show igmp-snooping statistics global | 228 |
| 30.4.9 | show igmp-snooping statistics interface | 228 |
| 30.5 | show | 229 |
| 30.5.1 | show mac-filter-table igmp-snooping | 229 |
| 30.6 | clear | 230 |
| 30.6.1 | clear igmp-snooping | 230 |
| 31 | Interface | 231 |
| 31.1 | shutdown | 232 |
| 31.1.1 | shutdown | 232 |
| 31.2 | auto-negotiate | 233 |
| 31.2.1 | auto-negotiate | 233 |
| 31.3 | auto-power-down | 234 |
| 31.3.1 | auto-power-down | 234 |
| 31.4 | cable-crossing | 235 |
| 31.4.1 | cable-crossing | 235 |
| 31.5 | linktraps | 236 |
| 31.5.1 | linktraps | 236 |
| 31.6 | link-loss-alert | 237 |
| 31.6.1 | link-loss-alert operation | 237 |
| 31.7 | speed | 238 |
| 31.7.1 | speed | 238 |
| 31.8 | name | 239 |
| 31.8.1 | name | 239 |
| 31.9 | power-state | 240 |
| 31.9.1 | power-state | 240 |
| 31.10 | mac-filter | 241 |
| 31.10.1 | mac-filter | 241 |
| 31.11 | led-signaling | 242 |
| 31.11.1 | led-signaling operation | 242 |
| 31.12 | show | 243 |
| 31.12.1 | show port | 243 |
| 31.13 | show | 244 |
| 31.13.1 | show link-loss-alert | 244 |
| 31.14 | show | 245 |
| 31.14.1 | show led-signaling operation | 245 |
| 32 | Interface Statistics | 247 |
| 32.1 | utilization | 248 |
| 32.1.1 | utilization control-interval | 248 |
| 32.1.2 | utilization alarm-threshold lower | 248 |
| 32.1.3 | utilization alarm-threshold upper | 248 |
| 32.2 | clear | 250 |
| 32.2.1 | clear port-statistics | 250 |

| | | |
|-----------|---|------------|
| 32.3 | show | 251 |
| 32.3.1 | show interface counters | 251 |
| 32.3.2 | show interface layout | 251 |
| 32.3.3 | show interface utilization | 251 |
| 32.3.4 | show interface statistics | 252 |
| 32.3.5 | show interface ether-stats | 252 |
| 33 | Intern | 253 |
| 33.1 | help | 254 |
| 33.2 | logout | 255 |
| 33.3 | history | 256 |
| 33.4 | vlan-mode | 257 |
| 33.4.1 | vlan-mode | 257 |
| 33.5 | exit | 258 |
| 33.6 | end | 259 |
| 33.7 | serviceshell | 260 |
| 33.7.1 | serviceshell deactivate | 260 |
| 33.8 | serviceshell-f | 261 |
| 33.8.1 | serviceshell-f deactivate | 261 |
| 33.9 | traceroute | 262 |
| 33.9.1 | traceroute maxttl | 262 |
| 33.10 | traceroute | 263 |
| 33.10.1 | traceroute source | 263 |
| 33.11 | reboot | 264 |
| 33.11.1 | reboot after | 264 |
| 33.12 | ping | 265 |
| 33.12.1 | ping | 265 |
| 33.13 | ping | 266 |
| 33.13.1 | ping source | 266 |
| 33.14 | show | 267 |
| 33.14.1 | show reboot | 267 |
| 33.14.2 | show serviceshell | 267 |
| 34 | Open Shortest Path First (OSPF) | 269 |
| 34.1 | show | 270 |
| 34.1.1 | show ip ospf global | 270 |
| 34.1.2 | show ip ospf area | 270 |
| 34.1.3 | show ip ospf stub | 270 |
| 34.1.4 | show ip ospf database internal | 271 |
| 34.1.5 | show ip ospf database external | 271 |
| 34.1.6 | show ip ospf range | 271 |
| 34.1.7 | show ip ospf interface | 271 |
| 34.1.8 | show ip ospf virtual-link | 272 |
| 34.1.9 | show ip ospf virtual-neighbor | 272 |
| 34.1.10 | show ip ospf neighbor | 272 |
| 34.1.11 | show ip ospf statistics | 272 |
| 34.1.12 | show ip ospf re-distribute | 273 |
| 34.1.13 | show ip ospf nssa | 273 |
| 34.1.14 | show ip ospf route | 273 |
| 35 | Internet Protocol Version 4 (IPv4) | 275 |
| 35.1 | network | 276 |
| 35.1.1 | network protocol | 276 |
| 35.1.2 | network parms | 276 |

| | | |
|-----------|---|------------|
| 35.2 | clear | 277 |
| 35.2.1 | clear arp-table-switch | 277 |
| 35.3 | show | 278 |
| 35.3.1 | show network parms | 278 |
| 35.4 | show | 279 |
| 35.4.1 | show arp | 279 |
| 36 | Link Backup | 281 |
| 36.1 | link-backup | 282 |
| 36.1.1 | link-backup operation | 282 |
| 36.2 | link-backup | 283 |
| 36.2.1 | link-backup add | 283 |
| 36.2.2 | link-backup delete | 283 |
| 36.2.3 | link-backup modify | 284 |
| 36.3 | show | 285 |
| 36.3.1 | show link-backup operation | 285 |
| 36.3.2 | show link-backup pairs | 285 |
| 37 | Link Layer Discovery Protocol (LLDP) | 287 |
| 37.1 | lldp | 288 |
| 37.1.1 | lldp operation | 288 |
| 37.1.2 | lldp config chassis admin-state | 288 |
| 37.1.3 | lldp config chassis notification-interval | 289 |
| 37.1.4 | lldp config chassis re-init-delay | 289 |
| 37.1.5 | lldp config chassis tx-delay | 289 |
| 37.1.6 | lldp config chassis tx-hold-multiplier | 290 |
| 37.1.7 | lldp config chassis tx-interval | 290 |
| 37.2 | show | 291 |
| 37.2.1 | show lldp global | 291 |
| 37.2.2 | show lldp port | 291 |
| 37.2.3 | show lldp remote-data | 291 |
| 37.3 | lldp | 292 |
| 37.3.1 | lldp admin-state | 292 |
| 37.3.2 | lldp fdb-mode | 292 |
| 37.3.3 | lldp max-neighbors | 293 |
| 37.3.4 | lldp notification | 293 |
| 37.3.5 | lldp tlv inline-power | 293 |
| 37.3.6 | lldp tlv link-aggregation | 294 |
| 37.3.7 | lldp tlv mac-phy-config-state | 294 |
| 37.3.8 | lldp tlv max-frame-size | 294 |
| 37.3.9 | lldp tlv mgmt-addr | 295 |
| 37.3.10 | lldp tlv port-desc | 295 |
| 37.3.11 | lldp tlv port-vlan | 296 |
| 37.3.12 | lldp tlv protocol | 296 |
| 37.3.13 | lldp tlv sys-cap | 297 |
| 37.3.14 | lldp tlv sys-desc | 297 |
| 37.3.15 | lldp tlv sys-name | 297 |
| 37.3.16 | lldp tlv vlan-name | 298 |
| 37.3.17 | lldp tlv protocol-based-vlan | 298 |
| 37.3.18 | lldp tlv igmp | 299 |
| 37.3.19 | lldp tlv portsec | 299 |
| 37.3.20 | lldp tlv ptp | 299 |
| 37.3.21 | lldp tlv pnio | 300 |
| 37.3.22 | lldp tlv pnio-alias | 300 |
| 37.3.23 | lldp tlv pnio-mrp | 301 |
| 38 | Media Endpoint Discovery LLDP-MED | 303 |
| 38.1 | lldp | 304 |

| | | |
|-----------|--------------------------------------|------------|
| 38.1.1 | lldp med confignotification | 304 |
| 38.1.2 | lldp med transmit-tlv capabilities | 304 |
| 38.1.3 | lldp med transmit-tlv network-policy | 305 |
| 38.2 | lldp | 306 |
| 38.2.1 | lldp med faststartrepeatcount | 306 |
| 38.3 | show | 307 |
| 38.3.1 | show lldp med global | 307 |
| 38.3.2 | show lldp med interface | 307 |
| 38.3.3 | show lldp med local-device | 307 |
| 38.3.4 | show lldp med remote-device detail | 308 |
| 38.3.5 | show lldp med remote-device summary | 308 |
| 39 | Logging | 309 |
| 39.1 | logging | 310 |
| 39.1.1 | logging audit-trail | 310 |
| 39.1.2 | logging buffered severity | 310 |
| 39.1.3 | logging host add | 311 |
| 39.1.4 | logging host delete | 311 |
| 39.1.5 | logging host enable | 312 |
| 39.1.6 | logging host disable | 312 |
| 39.1.7 | logging host modify | 312 |
| 39.1.8 | logging syslog operation | 313 |
| 39.1.9 | logging current-console operation | 313 |
| 39.1.10 | logging current-console severity | 314 |
| 39.1.11 | logging console operation | 314 |
| 39.1.12 | logging console severity | 315 |
| 39.1.13 | logging persistent operation | 315 |
| 39.1.14 | logging persistent numfiles | 316 |
| 39.1.15 | logging persistent filesize | 316 |
| 39.1.16 | logging persistent severity-level | 316 |
| 39.1.17 | logging email operation | 317 |
| 39.1.18 | logging email from-addr | 317 |
| 39.1.19 | logging email duration | 318 |
| 39.1.20 | logging email severity urgent | 318 |
| 39.1.21 | logging email severity non-urgent | 319 |
| 39.1.22 | logging email to-addr add | 319 |
| 39.1.23 | logging email to-addr delete | 320 |
| 39.1.24 | logging email to-addr modify | 320 |
| 39.1.25 | logging email mail-server add | 320 |
| 39.1.26 | logging email mail-server delete | 321 |
| 39.1.27 | logging email mail-server modify | 321 |
| 39.1.28 | logging email subject add | 322 |
| 39.1.29 | logging email subject delete | 322 |
| 39.1.30 | logging email subject modify | 323 |
| 39.1.31 | logging email test msgtype | 323 |
| 39.2 | show | 324 |
| 39.2.1 | show logging buffered | 324 |
| 39.2.2 | show logging traplogs | 324 |
| 39.2.3 | show logging console | 324 |
| 39.2.4 | show logging persistent | 325 |
| 39.2.5 | show logging syslog | 325 |
| 39.2.6 | show logging host | 325 |
| 39.2.7 | show logging email statistics | 325 |
| 39.2.8 | show logging email global | 326 |
| 39.2.9 | show logging email to-addr | 326 |
| 39.2.10 | show logging email subject | 326 |
| 39.2.11 | show logging email mail-server | 326 |
| 39.3 | copy | 328 |
| 39.3.1 | copy eventlog buffered envm | 328 |
| 39.3.2 | copy eventlog buffered remote | 328 |
| 39.3.3 | copy eventlog persistent | 328 |

| | | |
|-----------|---|------------|
| 39.3.4 | copy traplog system envm | 329 |
| 39.3.5 | copy traplog system remote | 329 |
| 39.3.6 | copy audittrail system envm | 329 |
| 39.3.7 | copy audittrail system remote | 330 |
| 39.3.8 | copy mailcacert remote | 330 |
| 39.3.9 | copy mailcacert envm | 330 |
| 39.3.10 | copy syslogcacert remote | 331 |
| 39.3.11 | copy syslogcacert envm | 331 |
| 39.4 | clear | 332 |
| 39.4.1 | clear logging buffered | 332 |
| 39.4.2 | clear logging persistent | 332 |
| 39.4.3 | clear logging email statistics | 332 |
| 39.4.4 | clear eventlog | 333 |
| 40 | Parallel Redundancy Protocol (PRP) | 335 |
| 40.1 | prp | 336 |
| 40.1.1 | prp operation | 336 |
| 40.1.2 | prp instance | 336 |
| 40.2 | show | 338 |
| 40.2.1 | show prp global | 338 |
| 40.2.2 | show prp instance | 338 |
| 40.2.3 | show prp node-table | 338 |
| 40.2.4 | show prp proxy-node-table | 339 |
| 40.2.5 | show prp counters | 339 |
| 40.3 | clear | 340 |
| 40.3.1 | clear prp proxy-node-table | 340 |
| 40.3.2 | clear prp node-table | 340 |
| 40.3.3 | clear prp counters | 340 |
| 41 | MAC Notification | 341 |
| 41.1 | mac | 342 |
| 41.1.1 | mac notification operation | 342 |
| 41.1.2 | mac notification interval | 342 |
| 41.2 | mac | 343 |
| 41.2.1 | mac notification operation | 343 |
| 41.3 | show | 344 |
| 41.3.1 | show mac notification global | 344 |
| 41.3.2 | show mac notification interface | 344 |
| 42 | Management Access | 345 |
| 42.1 | network | 346 |
| 42.1.1 | network management access web timeout | 346 |
| 42.1.2 | network management access add | 346 |
| 42.1.3 | network management access delete | 347 |
| 42.1.4 | network management access modify | 347 |
| 42.1.5 | network management access operation | 348 |
| 42.1.6 | network management access status | 349 |
| 42.2 | show | 350 |
| 42.2.1 | show network management access global | 350 |
| 42.2.2 | show network management access rules | 350 |
| 43 | Modbus | 351 |
| 43.1 | modbus-tcp | 352 |
| 43.1.1 | modbus-tcp operation | 352 |
| 43.1.2 | modbus-tcp write-access | 352 |
| 43.1.3 | modbus-tcp port | 353 |
| 43.1.4 | modbus-tcp max-sessions | 353 |

| | | |
|-----------|---|------------|
| 43.2 | show | 354 |
| 43.2.1 | show modbus-tcp | 354 |
| 44 | Media Redundancy Protocol (MRP) | 355 |
| 44.1 | mrp | 356 |
| 44.1.1 | mrp domain modify advanced-mode | 356 |
| 44.1.2 | mrp domain modify manager-priority | 356 |
| 44.1.3 | mrp domain modify mode | 356 |
| 44.1.4 | mrp domain modify name | 357 |
| 44.1.5 | mrp domain modify operation | 357 |
| 44.1.6 | mrp domain modify port primary | 357 |
| 44.1.7 | mrp domain modify port secondary | 358 |
| 44.1.8 | mrp domain modify recovery-delay | 358 |
| 44.1.9 | mrp domain modify round-trip-delay | 358 |
| 44.1.10 | mrp domain modify vlan | 359 |
| 44.1.11 | mrp domain add default-domain | 359 |
| 44.1.12 | mrp domain add domain-id | 359 |
| 44.1.13 | mrp domain delete | 359 |
| 44.1.14 | mrp operation | 360 |
| 44.2 | show | 361 |
| 44.2.1 | show mrp | 361 |
| 45 | MRP IEEE | 363 |
| 45.1 | mrp-ieee | 364 |
| 45.1.1 | mrp-ieee global join-time | 364 |
| 45.1.2 | mrp-ieee global leave-time | 364 |
| 45.1.3 | mrp-ieee global leave-all-time | 365 |
| 45.2 | show | 366 |
| 45.2.1 | show mrp-ieee global interface | 366 |
| 46 | MRP IEEE MMRP | 367 |
| 46.1 | mrp-ieee | 368 |
| 46.1.1 | mrp-ieee mmrp vlan-id | 368 |
| 46.2 | show | 369 |
| 46.2.1 | show mrp-ieee mmrp global | 369 |
| 46.2.2 | show mrp-ieee mmrp interface | 369 |
| 46.2.3 | show mrp-ieee mmrp statistics global | 369 |
| 46.2.4 | show mrp-ieee mmrp statistics interface | 370 |
| 46.2.5 | show mrp-ieee mmrp service-requirement forward-all vlan | 370 |
| 46.2.6 | show mrp-ieee mmrp service-requirement forbidden vlan | 370 |
| 46.3 | mrp-ieee | 371 |
| 46.3.1 | mrp-ieee mmrp operation | 371 |
| 46.3.2 | mrp-ieee mmrp periodic-machine | 371 |
| 46.4 | clear | 372 |
| 46.4.1 | clear mrp-ieee mmrp | 372 |
| 46.5 | mrp-ieee | 373 |
| 46.5.1 | mrp-ieee mmrp operation | 373 |
| 46.5.2 | mrp-ieee mmrp restrict-register | 373 |
| 46.6 | show | 374 |
| 46.6.1 | show mac-filter-table mmrp | 374 |
| 47 | MRP IEEE MVRP | 375 |
| 47.1 | mrp-ieee | 376 |
| 47.1.1 | mrp-ieee mvrp operation | 376 |
| 47.1.2 | mrp-ieee mvrp periodic-machine | 376 |
| 47.2 | mrp-ieee | 377 |

| | | |
|-----------|--|------------|
| 47.2.1 | mrp-ieee mvrp operation | 377 |
| 47.2.2 | mrp-ieee mvrp restrict-register | 377 |
| 47.3 | show | 378 |
| 47.3.1 | show mrp-ieee mvrp global | 378 |
| 47.3.2 | show mrp-ieee mvrp interface | 378 |
| 47.3.3 | show mrp-ieee mvrp statistics global | 378 |
| 47.3.4 | show mrp-ieee mvrp statistics interface | 379 |
| 47.4 | clear | 380 |
| 47.4.1 | clear mrp-ieee mvrp | 380 |
| 48 | Out-of-band Management | 381 |
| 48.1 | network | 382 |
| 48.1.1 | network out-of-band operation | 382 |
| 48.1.2 | network out-of-band protocol | 382 |
| 48.1.3 | network out-of-band parms | 383 |
| 48.2 | show | 384 |
| 49 | Protocol Based VLAN | 385 |
| 49.1 | vlan | 386 |
| 49.1.1 | vlan protocol group add | 386 |
| 49.1.2 | vlan protocol group modify | 386 |
| 49.1.3 | vlan protocol group delete | 387 |
| 49.2 | vlan | 388 |
| 49.2.1 | vlan protocol group add | 388 |
| 49.2.2 | vlan protocol group delete | 388 |
| 49.3 | show | 389 |
| 50 | Port Monitor | 391 |
| 50.1 | port-monitor | 392 |
| 50.1.1 | port-monitor operation | 392 |
| 50.2 | port-monitor | 393 |
| 50.2.1 | port-monitor condition crc-fragments interval | 393 |
| 50.2.2 | port-monitor condition crc-fragments count | 393 |
| 50.2.3 | port-monitor condition crc-fragments mode | 393 |
| 50.2.4 | port-monitor condition link-flap interval | 394 |
| 50.2.5 | port-monitor condition link-flap count | 394 |
| 50.2.6 | port-monitor condition link-flap mode | 394 |
| 50.2.7 | port-monitor condition duplex-mismatch mode | 395 |
| 50.2.8 | port-monitor condition overload-detection traffic-type | 395 |
| 50.2.9 | port-monitor condition overload-detection unit | 396 |
| 50.2.10 | port-monitor condition overload-detection upper-threshold | 396 |
| 50.2.11 | port-monitor condition overload-detection lower-threshold | 396 |
| 50.2.12 | port-monitor condition overload-detection polling-interval | 397 |
| 50.2.13 | port-monitor condition overload-detection mode | 397 |
| 50.2.14 | port-monitor condition speed-duplex mode | 397 |
| 50.2.15 | port-monitor condition speed-duplex speed | 398 |
| 50.2.16 | port-monitor condition speed-duplex clear | 398 |
| 50.2.17 | port-monitor action | 398 |
| 50.2.18 | port-monitor reset | 399 |
| 50.3 | show | 400 |
| 50.3.1 | show port-monitor operation | 400 |
| 50.3.2 | show port-monitor brief | 400 |
| 50.3.3 | show port-monitor overload-detection counters | 400 |
| 50.3.4 | show port-monitor overload-detection port | 401 |
| 50.3.5 | show port-monitor speed-duplex | 401 |
| 50.3.6 | show port-monitor port | 401 |
| 50.3.7 | show port-monitor link-flap | 401 |
| 50.3.8 | show port-monitor crc-fragments | 402 |

| | | |
|-----------|--|------------|
| 51 | Port Security | 403 |
| 51.1 | port-security | 404 |
| | 51.1.1 port-security operation | 404 |
| 51.2 | port-security | 405 |
| | 51.2.1 port-security operation | 405 |
| | 51.2.2 port-security max-dynamic | 405 |
| | 51.2.3 port-security max-static | 406 |
| | 51.2.4 port-security mac-address add | 406 |
| | 51.2.5 port-security mac-address move | 406 |
| | 51.2.6 port-security mac-address delete | 406 |
| | 51.2.7 port-security violation-traps | 407 |
| 51.3 | show | 408 |
| | 51.3.1 show port-security global | 408 |
| | 51.3.2 show port-security interface | 408 |
| | 51.3.3 show port-security dynamic | 408 |
| | 51.3.4 show port-security static | 409 |
| | 51.3.5 show port-security violation | 409 |
| 52 | Profinet IO | 411 |
| 52.1 | profinet | 412 |
| | 52.1.1 profinet operation | 412 |
| | 52.1.2 profinet name-of-station | 412 |
| 52.2 | profinet | 413 |
| | 52.2.1 profinet dcp-mode | 413 |
| 52.3 | copy | 414 |
| | 52.3.1 copy gsdml-profinet system remote | 414 |
| | 52.3.2 copy gsdml-profinet system envm | 414 |
| 52.4 | show | 415 |
| | 52.4.1 show profinet global | 415 |
| | 52.4.2 show profinet port | 415 |
| 53 | Precision Time Protocol (PTP) | 417 |
| 53.1 | ptp | 418 |
| | 53.1.1 ptp operation | 418 |
| | 53.1.2 ptp clock-mode | 418 |
| | 53.1.3 ptp sync-lower-bound | 419 |
| | 53.1.4 ptp sync-upper-bound | 419 |
| | 53.1.5 ptp management | 419 |
| | 53.1.6 ptp v2-transparent-clock syntonization | 420 |
| | 53.1.7 ptp v2-transparent-clock network-protocol | 420 |
| | 53.1.8 ptp v2-transparent-clock multi-domain | 420 |
| | 53.1.9 ptp v2-transparent-clock sync-local-clock | 421 |
| | 53.1.10 ptp v2-transparent-clock delay-mechanism | 421 |
| | 53.1.11 ptp v2-transparent-clock primary-domain | 421 |
| | 53.1.12 ptp v2-transparent-clock vlan | 422 |
| | 53.1.13 ptp v2-transparent-clock vlan-priority | 422 |
| | 53.1.14 ptp v2-boundary-clock domain | 422 |
| | 53.1.15 ptp v2-boundary-clock priority1 | 423 |
| | 53.1.16 ptp v2-boundary-clock priority2 | 423 |
| | 53.1.17 ptp v2-boundary-clock utc-offset | 423 |
| | 53.1.18 ptp v2-boundary-clock utc-offset-valid | 423 |
| 53.2 | ptp | 425 |
| | 53.2.1 ptp v2-transparent-clock operation | 425 |
| | 53.2.2 ptp v2-transparent-clock asymmetry | 425 |
| | 53.2.3 ptp v2-transparent-clock pdelay-interval | 426 |
| | 53.2.4 ptp v2-boundary-clock operation | 426 |
| | 53.2.5 ptp v2-boundary-clock pdelay-interval | 426 |

| | | |
|-----------|---|------------|
| 53.2.6 | ptp v2-boundary-clock announce-interval | 427 |
| 53.2.7 | ptp v2-boundary-clock sync-interval | 427 |
| 53.2.8 | ptp v2-boundary-clock announce-timeout | 428 |
| 53.2.9 | ptp v2-boundary-clock asymmetry | 428 |
| 53.2.10 | ptp v2-boundary-clock v1-compatibility-mode | 428 |
| 53.2.11 | ptp v2-boundary-clock delay-mechanism | 429 |
| 53.2.12 | ptp v2-boundary-clock network-protocol | 429 |
| 53.2.13 | ptp v2-boundary-clock vlan-priority | 429 |
| 53.2.14 | ptp v2-boundary-clock vlan | 430 |
| 53.3 | show | 431 |
| 53.3.1 | show ptp | 431 |
| 54 | Password Management | 433 |
| 54.1 | passwords | 434 |
| 54.1.1 | passwords min-length | 434 |
| 54.1.2 | passwords max-login-attempts | 434 |
| 54.1.3 | passwords min-uppercase-chars | 434 |
| 54.1.4 | passwords min-lowercase-chars | 435 |
| 54.1.5 | passwords min-numeric-chars | 435 |
| 54.1.6 | passwords min-special-chars | 435 |
| 54.2 | show | 436 |
| 54.2.1 | show passwords | 436 |
| 55 | Radius | 437 |
| 55.1 | authorization | 438 |
| 55.1.1 | authorization network radius | 438 |
| 55.2 | radius | 439 |
| 55.2.1 | radius accounting mode | 439 |
| 55.2.2 | radius server attribute 4 | 439 |
| 55.2.3 | radius server acct add | 440 |
| 55.2.4 | radius server acct delete | 440 |
| 55.2.5 | radius server acct modify | 440 |
| 55.2.6 | radius server auth add | 441 |
| 55.2.7 | radius server auth delete | 441 |
| 55.2.8 | radius server auth modify | 442 |
| 55.2.9 | radius server retransmit | 442 |
| 55.2.10 | radius server timeout | 443 |
| 55.3 | show | 444 |
| 55.3.1 | show radius global | 444 |
| 55.3.2 | show radius auth servers | 444 |
| 55.3.3 | show radius auth statistics | 444 |
| 55.3.4 | show radius acct statistics | 445 |
| 55.3.5 | show radius acct servers | 445 |
| 55.4 | clear | 446 |
| 55.4.1 | clear radius | 446 |
| 56 | Remote Monitoring (RMON) | 447 |
| 56.1 | rmon-alarm | 448 |
| 56.1.1 | rmon-alarm add | 448 |
| 56.1.2 | rmon-alarm enable | 448 |
| 56.1.3 | rmon-alarm disable | 449 |
| 56.1.4 | rmon-alarm delete | 449 |
| 56.1.5 | rmon-alarm modify | 449 |
| 56.2 | show | 451 |
| 56.2.1 | show rmon statistics | 451 |
| 56.2.2 | show rmon alarm | 451 |
| 57 | Script File | 453 |

| | | |
|-----------|--|------------|
| 57.1 | script | 454 |
| | 57.1.1 script apply | 454 |
| | 57.1.2 script validate | 454 |
| | 57.1.3 script list system | 454 |
| | 57.1.4 script list envm | 455 |
| | 57.1.5 script delete | 455 |
| 57.2 | copy | 456 |
| | 57.2.1 copy script envm | 456 |
| | 57.2.2 copy script remote | 456 |
| | 57.2.3 copy script nvm | 457 |
| | 57.2.4 copy script running-config nvm | 457 |
| | 57.2.5 copy script running-config envm | 457 |
| | 57.2.6 copy script running-config remote | 458 |
| 57.3 | show | 459 |
| | 57.3.1 show script envm | 459 |
| | 57.3.2 show script system | 459 |
| 58 | Selftest | 461 |
| 58.1 | selftest | 462 |
| | 58.1.1 selftest action | 462 |
| | 58.1.2 selftest ramtest | 462 |
| | 58.1.3 selftest system-monitor | 463 |
| | 58.1.4 selftest boot-default-on-error | 463 |
| 58.2 | show | 464 |
| | 58.2.1 show selftest action | 464 |
| | 58.2.2 show selftest settings | 464 |
| 59 | Small Form-factor Pluggable (SFP) | 465 |
| 59.1 | show | 466 |
| | 59.1.1 show sfp | 466 |
| 60 | Signal Contact | 467 |
| 60.1 | signal-contact | 468 |
| | 60.1.1 signal-contact mode | 468 |
| | 60.1.2 signal-contact monitor link-failure | 468 |
| | 60.1.3 signal-contact monitor envm-not-in-sync | 469 |
| | 60.1.4 signal-contact monitor envm-removal | 469 |
| | 60.1.5 signal-contact monitor temperature | 470 |
| | 60.1.6 signal-contact monitor ring-redundancy | 470 |
| | 60.1.7 signal-contact monitor power-supply | 470 |
| | 60.1.8 signal-contact state | 471 |
| | 60.1.9 signal-contact trap | 471 |
| 60.2 | signal-contact | 472 |
| | 60.2.1 signal-contact link-alarm | 472 |
| 60.3 | show | 473 |
| | 60.3.1 show signal-contact | 473 |
| 61 | Switched Monitoring (SMON) | 475 |
| 61.1 | monitor | 476 |
| | 61.1.1 monitor session | 476 |
| 61.2 | show | 478 |
| | 61.2.1 show monitor session | 478 |
| 61.3 | clear | 479 |
| | 61.3.1 clear monitor session | 479 |
| 62 | Simple Network Management Protocol (SNMP) | 481 |

| | | |
|-----------|--|------------|
| 62.1 | snmp | 482 |
| | 62.1.1 snmp access version v1 | 482 |
| | 62.1.2 snmp access version v2 | 482 |
| | 62.1.3 snmp access version v3 | 483 |
| | 62.1.4 snmp access port | 483 |
| | 62.1.5 snmp access snmp-over-802 | 483 |
| 62.2 | show | 484 |
| | 62.2.1 show snmp access | 484 |
| 63 | SNMP Community | 485 |
| 63.1 | snmp | 486 |
| | 63.1.1 snmp community ro | 486 |
| | 63.1.2 snmp community rw | 486 |
| 63.2 | show | 487 |
| | 63.2.1 show snmp community | 487 |
| 64 | SNMP Logging | 489 |
| 64.1 | logging | 490 |
| | 64.1.1 logging snmp-request get operation | 490 |
| | 64.1.2 logging snmp-request get severity | 490 |
| | 64.1.3 logging snmp-request set operation | 491 |
| | 64.1.4 logging snmp-request set severity | 492 |
| 64.2 | show | 493 |
| | 64.2.1 show logging snmp | 493 |
| 65 | Simple Network Time Protocol (SNTP) | 495 |
| 65.1 | sntp | 496 |
| | 65.1.1 sntp client operation | 496 |
| | 65.1.2 sntp client operating-mode | 496 |
| | 65.1.3 sntp client request-interval | 497 |
| | 65.1.4 sntp client broadcast-rcv-timeout | 497 |
| | 65.1.5 sntp client disable-after-sync | 497 |
| | 65.1.6 sntp client server add | 498 |
| | 65.1.7 sntp client server delete | 498 |
| | 65.1.8 sntp client server mode | 498 |
| | 65.1.9 sntp server operation | 499 |
| | 65.1.10 sntp server port | 499 |
| | 65.1.11 sntp server only-if-synchronized | 499 |
| | 65.1.12 sntp server broadcast operation | 500 |
| | 65.1.13 sntp server broadcast address | 500 |
| | 65.1.14 sntp server broadcast port | 500 |
| | 65.1.15 sntp server broadcast interval | 501 |
| | 65.1.16 sntp server broadcast vlan | 501 |
| 65.2 | show | 502 |
| | 65.2.1 show sntp global | 502 |
| | 65.2.2 show sntp client status | 502 |
| | 65.2.3 show sntp client server | 502 |
| | 65.2.4 show sntp server status | 503 |
| | 65.2.5 show sntp server broadcast | 503 |
| 66 | Spanning Tree | 505 |
| 66.1 | spanning-tree | 506 |
| | 66.1.1 spanning-tree operation | 506 |
| | 66.1.2 spanning-tree bpdu-filter | 506 |
| | 66.1.3 spanning-tree bpdu-guard | 507 |
| | 66.1.4 spanning-tree bpdu-migration-check | 507 |
| | 66.1.5 spanning-tree forceversion | 507 |
| | 66.1.6 spanning-tree forward-time | 508 |

| | | |
|-----------|---|------------|
| 66.1.7 | spanning-tree hello-time | 508 |
| 66.1.8 | spanning-tree hold-count | 508 |
| 66.1.9 | spanning-tree max-age | 508 |
| 66.1.10 | spanning-tree ring-only-mode operation | 509 |
| 66.1.11 | spanning-tree ring-only-mode first-port | 509 |
| 66.1.12 | spanning-tree ring-only-mode second-port | 509 |
| 66.1.13 | spanning-tree mst | 510 |
| 66.2 | spanning-tree | 511 |
| 66.2.1 | spanning-tree mode | 511 |
| 66.2.2 | spanning-tree bpdu-flood | 511 |
| 66.2.3 | spanning-tree edge-auto | 512 |
| 66.2.4 | spanning-tree edge-port | 512 |
| 66.2.5 | spanning-tree guard-loop | 512 |
| 66.2.6 | spanning-tree guard-root | 513 |
| 66.2.7 | spanning-tree guard-tcn | 513 |
| 66.2.8 | spanning-tree cost | 514 |
| 66.2.9 | spanning-tree priority | 514 |
| 66.3 | show | 515 |
| 66.3.1 | show spanning-tree global | 515 |
| 66.3.2 | show spanning-tree mst instance | 515 |
| 66.3.3 | show spanning-tree mst port | 515 |
| 66.3.4 | show spanning-tree port | 516 |
| 67 | Secure Shell (SSH) | 517 |
| 67.1 | ssh | 518 |
| 67.1.1 | ssh server | 518 |
| 67.1.2 | ssh timeout | 518 |
| 67.1.3 | ssh port | 519 |
| 67.1.4 | ssh max-sessions | 519 |
| 67.1.5 | ssh outbound max-sessions | 519 |
| 67.1.6 | ssh outbound timeout | 519 |
| 67.1.7 | ssh key rsa | 520 |
| 67.1.8 | ssh key dsa | 520 |
| 67.2 | copy | 521 |
| 67.2.1 | copy sshkey remote | 521 |
| 67.2.2 | copy sshkey envm | 521 |
| 67.3 | show | 522 |
| 67.3.1 | show ssh | 522 |
| 68 | Storm Control | 523 |
| 68.1 | storm-control | 524 |
| 68.1.1 | storm-control flow-control | 524 |
| 68.2 | traffic-shape | 525 |
| 68.2.1 | traffic-shape bw | 525 |
| 68.3 | mtu | 526 |
| 68.3.1 | mtu | 526 |
| 68.4 | mtu | 527 |
| 68.4.1 | mtu | 527 |
| 68.5 | mtu | 528 |
| 68.5.1 | mtu | 528 |
| 68.6 | storm-control | 529 |
| 68.6.1 | storm-control flow-control | 529 |
| 68.6.2 | storm-control ingress unit | 529 |
| 68.6.3 | storm-control ingress threshold | 530 |
| 68.6.4 | storm-control ingress unicast operation | 530 |
| 68.6.5 | storm-control ingress multicast operation | 530 |
| 68.6.6 | storm-control ingress broadcast operation | 531 |

| | | |
|-----------|---|------------|
| 68.7 | show | 532 |
| | 68.7.1show storm-control flow-control | 532 |
| | 68.7.2show storm-control ingress | 532 |
| | 68.7.3show traffic-shape | 532 |
| | 68.7.4show mtu | 533 |
| 69 | System | 535 |
| 69.1 | system | 536 |
| | 69.1.1system name | 536 |
| | 69.1.2system location | 536 |
| | 69.1.3system contact | 536 |
| | 69.1.4system pre-login-banner operation | 537 |
| | 69.1.5system pre-login-banner text | 537 |
| | 69.1.6system resources operation | 538 |
| 69.2 | temperature | 539 |
| | 69.2.1temperature upper-limit | 539 |
| | 69.2.2temperature lower-limit | 539 |
| 69.3 | show | 540 |
| | 69.3.1show eventlog | 540 |
| | 69.3.2show system info | 540 |
| | 69.3.3show system pre-login-banner | 540 |
| | 69.3.4show system flash-status | 541 |
| | 69.3.5show system temperature limits | 541 |
| | 69.3.6show system temperature extremes | 541 |
| | 69.3.7show system temperature histogram | 541 |
| | 69.3.8show system temperature counters | 542 |
| | 69.3.9show system resources | 542 |
| | 69.3.10show psu slot | 542 |
| | 69.3.11show psu unit | 542 |
| 70 | Telnet | 543 |
| 70.1 | telnet | 544 |
| | 70.1.1telnet server | 544 |
| | 70.1.2telnet timeout | 544 |
| | 70.1.3telnet port | 545 |
| | 70.1.4telnet max-sessions | 545 |
| 70.2 | telnet | 546 |
| | 70.2.1telnet | 546 |
| 70.3 | show | 547 |
| | 70.3.1show telnet | 547 |
| 71 | Traps | 549 |
| 71.1 | snmp | 550 |
| | 71.1.1snmp trap operation | 550 |
| | 71.1.2snmp trap mode | 550 |
| | 71.1.3snmp trap delete | 551 |
| | 71.1.4snmp trap add | 551 |
| 71.2 | show | 552 |
| | 71.2.1show snmp traps | 552 |
| 72 | User Management | 553 |
| 72.1 | show | 554 |
| | 72.1.1show custom-role global | 554 |
| | 72.1.2show custom-role commands | 554 |
| 73 | Users | 555 |

| | | |
|-----------|--|------------|
| 73.1 | users | 556 |
| | 73.1.1 users add | 556 |
| | 73.1.2 users delete | 556 |
| | 73.1.3 users enable | 556 |
| | 73.1.4 users disable | 557 |
| | 73.1.5 users password | 557 |
| | 73.1.6 users snmpv3 authentication | 557 |
| | 73.1.7 users snmpv3 encryption | 558 |
| | 73.1.8 users access-role | 558 |
| | 73.1.9 users lock-status | 558 |
| | 73.1.10 users password-policy-check | 559 |
| 73.2 | show | 560 |
| | 73.2.1 show users | 560 |
| 74 | Virtual LAN (VLAN) | 561 |
| 74.1 | name | 562 |
| | 74.1.1 name | 562 |
| 74.2 | vlan-unaware-mode | 563 |
| | 74.2.1 vlan-unaware-mode | 563 |
| 74.3 | vlan | 564 |
| | 74.3.1 vlan add | 564 |
| | 74.3.2 vlan delete | 564 |
| 74.4 | vlan | 565 |
| | 74.4.1 vlan acceptframe | 565 |
| | 74.4.2 vlan ingressfilter | 565 |
| | 74.4.3 vlan priority | 566 |
| | 74.4.4 vlan pvid | 566 |
| | 74.4.5 vlan tagging | 566 |
| | 74.4.6 vlan participation include | 567 |
| | 74.4.7 vlan participation exclude | 567 |
| | 74.4.8 vlan participation auto | 567 |
| 74.5 | show | 568 |
| | 74.5.1 show vlan id | 568 |
| | 74.5.2 show vlan brief | 568 |
| | 74.5.3 show vlan port | 568 |
| | 74.5.4 show vlan member current | 569 |
| | 74.5.5 show vlan member static | 569 |
| 74.6 | network | 570 |
| | 74.6.1 network management vlan | 570 |
| | 74.6.2 network management priority dot1p | 570 |
| | 74.6.3 network management priority ip-dscp | 570 |
| 75 | Voice VLAN | 571 |
| 75.1 | voice | 572 |
| | 75.1.1 voice vlan | 572 |
| 75.2 | voice | 573 |
| | 75.2.1 voice vlan vlan-id | 573 |
| | 75.2.2 voice vlan dot1p | 573 |
| | 75.2.3 voice vlan none | 574 |
| | 75.2.4 voice vlan untagged | 574 |
| | 75.2.5 voice vlan disable | 574 |
| | 75.2.6 voice vlan auth | 574 |
| | 75.2.7 voice vlan data priority | 575 |
| 75.3 | show | 576 |
| | 75.3.1 show voice vlan global | 576 |
| | 75.3.2 show voice vlan interface | 576 |

A Further Support

577

Safety instructions

WARNING

UNCONTROLLED MACHINE ACTIONS

To avoid uncontrolled machine actions caused by data loss, configure all the data transmission devices individually.

Before you start any machine which is controlled via data transmission, be sure to complete the configuration of all data transmission devices.

Failure to follow these instructions can result in death, serious injury, or equipment damage.

About this Manual

The “Command Line Interface” reference manual contains detailed information on using the Command Line Interface to operate the individual functions of the device.

The “GUI” reference manual contains detailed information on using the graphical interface to operate the individual functions of the device.

The “Installation” user manual contains a device description, safety instructions, a description of the display, and the other information that you need to install the device.

The “Basic Configuration” user manual contains the information you need to start operating the device. It takes you step by step from the first startup operation through to the basic settings for operation in your environment.

The “Redundancy Configuration” user manual document contains the information you require to select the suitable redundancy procedure and configure it.

The document “HiView User Manual” contains information about the GUI application HiView. This application offers you the possibility to use the graphical user interface without other applications such as a Web browser or an installed Java Runtime Environment (JRE).

The Industrial HiVision Network Management software provides you with additional options for smooth configuration and monitoring:

- ▶ ActiveX control for SCADA integration
- ▶ Auto-topology discovery
- ▶ Browser interface
- ▶ Client/server structure
- ▶ Event handling
- ▶ Event log
- ▶ Simultaneous configuration of multiple devices
- ▶ Graphical user interface with network layout
- ▶ SNMP/OPC gateway

1 Command reference

2 Address Conflict Detection (ACD)

2.1 address-conflict

Configure the address conflict settings.

2.1.1 address-conflict operation

Enable or disable the address conflict component.

- ▶ Mode: Global Config Mode
- ▶ Privilege Level: Operator
- ▶ Format: address-conflict operation

■ no address-conflict operation

Disable the option

- ▶ Mode: Global Config Mode
- ▶ Privilege Level: Operator
- ▶ Format: no address-conflict operation

2.1.2 address-conflict detection-mode

Configure the detection mode.

- ▶ Mode: Global Config Mode
- ▶ Privilege Level: Operator
- ▶ Format: address-conflict detection-mode <P-1>

| Parameter | Value | Meaning |
|-----------|--------------------|--|
| P-1 | active-and-passive | Configure active and passive detection. During the ip address configuration, if you set the detection to 'active', then the device sends ARP or NDP probes into the network, and if you set the detection to 'passive', then the device listens continuously on the network. |
| | active-only | Configure only active detection. During ip address configuration 'active' the device sends only one ARP or NDP probe into the network. |
| | passive-only | Configure passive detection. The device listens passively on the network to verify that another device does not have the same ip address assigned. |

2.1.3 address-conflict detection-ongoing

Enable or disable the ongoing detection. If enabled, the device sends periodic ARP or NDP probes.

- ▶ Mode: Global Config Mode
- ▶ Privilege Level: Operator
- ▶ Format: address-conflict detection-ongoing

■ no address-conflict detection-ongoing

Disable the option

- ▶ Mode: Global Config Mode
- ▶ Privilege Level: Operator
- ▶ Format: no address-conflict detection-ongoing

2.1.4 address-conflict delay

The maximum detection delay time in milliseconds. Time gap between ARP or NDP probes.

- ▶ Mode: Global Config Mode
- ▶ Privilege Level: Operator
- ▶ Format: address-conflict delay <P-1>

| Parameter | Value | Meaning |
|-----------|---------|---|
| P-1 | 20..500 | Time gap between consecutive ARP or NDP probes ([ms], default 200). |

2.1.5 address-conflict release-delay

Delay in seconds to the next ARP or NDP probe cycle after an ip address conflict was detected.

- ▶ Mode: Global Config Mode
- ▶ Privilege Level: Operator
- ▶ Format: address-conflict release-delay <P-1>

| Parameter | Value | Meaning |
|-----------|---------|---|
| P-1 | 3..3600 | Delay between consecutive probe cycles after a conflict was detected ([sec], default 15). |

2.1.6 address-conflict max-protection

Maximum number of frequent address protections.

- ▶ Mode: Global Config Mode
- ▶ Privilege Level: Operator
- ▶ Format: address-conflict max-protection <P-1>

| Parameter | Value | Meaning |
|-----------|--------|---|
| P-1 | 0..100 | Maximum number of frequent address protections (default 1). |

2.1.7 address-conflict protect-interval

Delay in milliseconds between two consecutive address protections.

- ▶ Mode: Global Config Mode
- ▶ Privilege Level: Operator
- ▶ Format: address-conflict protect-interval <P-1>

| Parameter | Value | Meaning |
|-----------|-----------|--|
| P-1 | 20..10000 | Delay between two consecutive protections ([ms], default 10000). |

2.1.8 address-conflict trap-status

If enabled, this trap reports an address conflict.

- ▶ Mode: Global Config Mode
- ▶ Privilege Level: Operator
- ▶ Format: address-conflict trap-status

■ no address-conflict trap-status

Disable the option

- ▶ Mode: Global Config Mode
- ▶ Privilege Level: Operator
- ▶ Format: no address-conflict trap-status

2.2 show

Display device options and settings.

2.2.1 show address-conflict global

Displays the component mode.

- ▶ **Mode:** Command is in all modes available.
- ▶ **Privilege Level:** Guest
- ▶ **Format:** show address-conflict global

2.2.2 show address-conflict detected

Displays the last detected address conflict.

- ▶ **Mode:** Command is in all modes available.
- ▶ **Privilege Level:** Guest
- ▶ **Format:** show address-conflict detected

2.2.3 show address-conflict fault-state

Displays the current conflict status.

- ▶ **Mode:** Command is in all modes available.
- ▶ **Privilege Level:** Guest
- ▶ **Format:** show address-conflict fault-state

2.2.4 show mac-address-conflict global

Displays the component mode.

- ▶ **Mode:** Command is in all modes available.
- ▶ **Privilege Level:** Guest
- ▶ **Format:** show mac-address-conflict global

3 Application Lists

3.1 appllists

Configure an application list.

3.1.1 appllists set-authlist

Set an authentication list reference that shall be used by given application.

- ▶ Mode: Global Config Mode
- ▶ Privilege Level: Administrator
- ▶ Format: `appllists set-authlist <P-1> <P-2>`

| Parameter | Value | Meaning |
|-----------|--------|---|
| P-1 | string | <application> Name of an application list. |
| P-2 | string | <authlist_name> Name of referenced authentication list. |

3.1.2 appllists enable

Activate a login application list.

- ▶ Mode: Global Config Mode
- ▶ Privilege Level: Administrator
- ▶ Format: `appllists enable <P-1>`

| Parameter | Value | Meaning |
|-----------|--------|--|
| P-1 | string | <application> Name of an application list. |

3.1.3 appllists disable

Deactivate a login application list.

- ▶ Mode: Global Config Mode
- ▶ Privilege Level: Administrator
- ▶ Format: `appllists disable <P-1>`

| Parameter | Value | Meaning |
|-----------|--------|--|
| P-1 | string | <application> Name of an application list. |

3.2 show

Display device options and settings.

3.2.1 show appllists

Display ordered methods for application lists.

- ▶ **Mode:** Command is in all modes available.
- ▶ **Privilege Level:** Administrator
- ▶ **Format:** show appllists

4 Authentication Lists

4.1 authlists

Configure an authentication list.

4.1.1 authlists add

Create a new login authentication list.

- ▶ Mode: Global Config Mode
- ▶ Privilege Level: Administrator
- ▶ Format: authlists add <P-1>

| Paramete Value | Meaning |
|----------------|---|
| P-1 string | <authlist_name> Name of an authentication list. |

4.1.2 authlists delete

Delete an existing login authentication list.

- ▶ Mode: Global Config Mode
- ▶ Privilege Level: Administrator
- ▶ Format: authlists delete <P-1>

| Paramete Value | Meaning |
|----------------|---|
| P-1 string | <authlist_name> Name of an authentication list. |

4.1.3 authlists set-policy

Set the policies of a login authentication list.

- ▶ Mode: Global Config Mode
- ▶ Privilege Level: Administrator
- ▶ Format: authlists set-policy <P-1> <P-2> [<P-3> [<P-4> [<P-5> [<P-6>]]]]

| Paramete Value | Meaning |
|----------------|---|
| P-1 string | <authlist_name> Name of an authentication list. |

| Parameter | Value | Meaning |
|-----------|--------|--|
| P-2 | reject | Authentication is rejected / not allowed |
| | local | Authentication by local user DB |
| | radius | Authentication by RADIUS server |
| | ias | Authentication by IAS server |
| | cam | Authentication by CAM server |
| | ldap | Authentication by remote server |
| P-3 | reject | Authentication is rejected / not allowed |
| | local | Authentication by local user DB |
| | radius | Authentication by RADIUS server |
| | ias | Authentication by IAS server |
| | cam | Authentication by CAM server |
| | ldap | Authentication by remote server |
| P-4 | reject | Authentication is rejected / not allowed |
| | local | Authentication by local user DB |
| | radius | Authentication by RADIUS server |
| | ias | Authentication by IAS server |
| | cam | Authentication by CAM server |
| | ldap | Authentication by remote server |
| P-5 | reject | Authentication is rejected / not allowed |
| | local | Authentication by local user DB |
| | radius | Authentication by RADIUS server |
| | ias | Authentication by IAS server |
| | cam | Authentication by CAM server |
| | ldap | Authentication by remote server |
| P-6 | reject | Authentication is rejected / not allowed |
| | local | Authentication by local user DB |
| | radius | Authentication by RADIUS server |
| | ias | Authentication by IAS server |
| | cam | Authentication by CAM server |
| | ldap | Authentication by remote server |

4.1.4 authlists enable

Activate a login authentication list.

- ▶ Mode: Global Config Mode
- ▶ Privilege Level: Administrator
- ▶ Format: authlists enable <P-1>

| Parameter | Value | Meaning |
|-----------|--------|---|
| P-1 | string | <authlist name> Name of an authentication list. |

4.1.5 authlists disable

Deactivate a login authentication list.

- ▶ Mode: Global Config Mode
- ▶ Privilege Level: Administrator
- ▶ Format: authlists disable <P-1>

| Parameter | Value | Meaning |
|-----------|--------|---|
| P-1 | string | <authlist name> Name of an authentication list. |

4.2 show

Display device options and settings.

4.2.1 show authlists

Display ordered methods for authentication lists.

- ▶ **Mode:** Command is in all modes available.
- ▶ **Privilege Level:** Administrator
- ▶ **Format:** show authlists

5 Auto Disable

5.1 auto-disable

Configure the Auto Disable condition settings.

5.1.1 auto-disable reason

Enables/disables port Recovery by reason on this device.

- ▶ Mode: Global Config Mode
- ▶ Privilege Level: Operator
- ▶ Format: auto-disable reason <P-1>

| Parameter | Value | Meaning |
|-----------|--------------------|---|
| P-1 | link-flap | Enable/disable link-flap. |
| | crc-error | Enable/disable crc-error. |
| | duplex-mismatch | Enable/disable duplex-mismatch. |
| | dhcp-snooping | Enable/disable dhcp-snooping. |
| | arp-rate | Enable/disable arp-rate. |
| | bpdu-rate | Enable/disable bpdu-rate. |
| | port-security | Enable/disable MAC based port security. |
| | overload-detection | Enable/disable overload-detection. |
| | speed-duplex | Enable/disable link speed and duplex monitor. |

■ no auto-disable reason

Disable the option

- ▶ Mode: Global Config Mode
- ▶ Privilege Level: Operator
- ▶ Format: no auto-disable reason <P-1>

5.2 auto-disable

Configure the Auto Disable condition settings.

5.2.1 auto-disable timer

Timer value in seconds after a deactivated port is activated again. Possible values are: 30-4294967295. A value of 0 disables the timer.

- ▶ Mode: Interface Range Mode
- ▶ Privilege Level: Operator
- ▶ Format: auto-disable timer <P-1>

| Parameter | Value | Meaning |
|-----------|--------------------|-------------------------|
| P-1 | xxx_30..4294967295 | Timer value in seconds. |

5.2.2 auto-disable reset

Reset the specific interface and reactivate the port.

- ▶ Mode: Interface Range Mode
- ▶ Privilege Level: Operator
- ▶ Format: auto-disable reset [<P-1>]

| Parameter | Value | Meaning |
|-----------|-------|-------------------------------------|
| P-1 | port | Press Enter to execute the command. |

■ no auto-disable reset

Disable the option

- ▶ Mode: Interface Range Mode
- ▶ Privilege Level: Operator
- ▶ Format: no auto-disable reset [<P-1>]

5.3 show

Display device options and settings.

5.3.1 show auto-disable brief

Display Auto Disable summary by interface.

- ▶ Mode: Command is in all modes available.
- ▶ Privilege Level: Guest
- ▶ Format: show auto-disable brief

5.3.2 show auto-disable reasons

Display summary of Auto Disable error reasons.

- ▶ Mode: Command is in all modes available.
- ▶ Privilege Level: Guest
- ▶ Format: show auto-disable reasons

6 Class Of Service

6.1 classofservice

Class of service configuration.

6.1.1 classofservice ip-dscp-mapping

ip-dscp-mapping configuration

- ▶ Mode: Global Config Mode
- ▶ Privilege Level: Operator
- ▶ Format: classofservice ip-dscp-mapping <P-1> <P-2> <P-3>

| Parameter | Value | Meaning |
|-----------|-------|---------|
| P-1 | af11 | |
| | af12 | |
| | af13 | |
| | af21 | |
| | af22 | |
| | af23 | |
| | af31 | |
| | af32 | |
| | af33 | |
| | af41 | |
| | af42 | |
| | af43 | |
| | be | |
| | cs0 | |
| | cs1 | |
| | cs2 | |
| | cs3 | |
| | cs4 | |
| | cs5 | |
| | cs6 | |
| | cs7 | |
| | ef | |
| | 0 | |
| | 1 | |
| | 2 | |
| | 3 | |
| | 4 | |
| | 5 | |
| | 6 | |
| | 7 | |
| | 8 | |
| | 9 | |
| | 10 | |
| | 11 | |
| 12 | | |
| 13 | | |
| 14 | | |
| 15 | | |
| 16 | | |
| 17 | | |
| 18 | | |
| 19 | | |
| 20 | | |
| 21 | | |
| 22 | | |
| 23 | | |
| 24 | | |
| 25 | | |
| 26 | | |
| 27 | | |
| 28 | | |
| 29 | | |
| 30 | | |
| 31 | | |
| 32 | | |
| 33 | | |
| 34 | | |

| Parameter | Value | Meaning |
|-----------|-------|--------------------------------|
| P-2 | 0..7 | Enter the Traffic Class value. |
| P-3 | 0..3 | Enter the Traffic Class value. |

6.1.2 classofservice dot1p-mapping

Enter a VLAN priority and the traffic class it should be mapped to.

- ▶ Mode: Global Config Mode
- ▶ Privilege Level: Operator
- ▶ Format: classofservice dot1p-mapping <P-1> <P-2> <P-3>

| Parameter | Value | Meaning |
|-----------|-------|------------------------------------|
| P-1 | 0..7 | Enter the 802.1p priority. |
| P-2 | 0..7 | Enter the Traffic Class value. |
| P-3 | 0..3 | Enter a number in the given range. |

6.2 classofservice

Interface classofservice configuration.

6.2.1 classofservice trust

trust configuration

- ▶ Mode: Interface Range Mode
- ▶ Privilege Level: Operator
- ▶ Format: classofservice trust <P-1>

| Parameter | Value | Meaning |
|-----------|-----------|---|
| P-1 | untrusted | Sets the class of service trust mode to untrusted |
| | dot1p | Sets the class of service trust mode to dot1p. |
| | ip-dscp | Sets the class of service trust mode to IP DSCP. |

6.3 cos-queue

COS queue configuration

6.3.1 cos-queue strict

strict priority scheduler (default)

- ▶ Mode: Global Config Mode
- ▶ Privilege Level: Operator
- ▶ Format: `cos-queue strict <P-1> <P-2>`

| Parameter | Value | Meaning |
|-----------|-------|------------------------------------|
| P-1 | 0..7 | Enter a Queue Id from 0 to 7. |
| P-2 | 0..3 | Enter a number in the given range. |

6.3.2 cos-queue weighted

weighted scheduler

- ▶ Mode: Global Config Mode
- ▶ Privilege Level: Operator
- ▶ Format: `cos-queue weighted <P-1> <P-2>`

| Parameter | Value | Meaning |
|-----------|-------|------------------------------------|
| P-1 | 0..7 | Enter a Queue Id from 0 to 7. |
| P-2 | 0..3 | Enter a number in the given range. |

6.3.3 cos-queue min-bandwidth

Minimum/guaranteed bandwidth for the queues when in weighted mode

- ▶ Mode: Global Config Mode
- ▶ Privilege Level: Operator
- ▶ Format: `cos-queue min-bandwidth <P-1> <P-2> <P-3>`

| Parameter | Value | Meaning |
|------------------|--------------|------------------------------------|
| P-1 | 0..3 | Enter a number in the given range. |
| P-2 | 0..7 | Enter a Queue Id from 0 to 7. |
| P-3 | 0..100 | Enter a number in the given range. |

6.4 show

Display device options and settings.

6.4.1 show classofservice ip-dscp-mapping

Show ip-dscp-mapping configuration.

- ▶ Mode: Command is in all modes available.
- ▶ Privilege Level: Guest
- ▶ Format: show classofservice ip-dscp-mapping

6.4.2 show classofservice dot1p-mapping

Display a table containing the vlan priority to traffic class mappings.

- ▶ Mode: Command is in all modes available.
- ▶ Privilege Level: Guest
- ▶ Format: show classofservice dot1p-mapping

6.4.3 show classofservice trust

Show a table containing the trust mode of all interfaces.

- ▶ Mode: Command is in all modes available.
- ▶ Privilege Level: Guest
- ▶ Format: show classofservice trust

6.4.4 show cos-queue

Show cosqueue parameters

- ▶ **Mode:** Command is in all modes available.
- ▶ **Privilege Level:** Guest
- ▶ **Format:** show cos-queue

7 Command Line Interface (CLI)

7.1 cli

Set the CLI preferences.

7.1.1 cli serial-timeout

Set login timeout for serial line connection to CLI. Setting to 0 will disable the timeout. The value is active after next login.

- ▶ Mode: Privileged Exec Mode
- ▶ Privilege Level: Operator
- ▶ Format: cli serial-timeout <P-1>

| Parameter | Value | Meaning |
|-----------|--------|---|
| P-1 | 0..160 | Enter a number in the given range. Setting to 0 will disable the timeout. |

7.1.2 cli prompt

Change the system prompt. Following wildcards are allowed: %d date, %t time, %i IP address, %m MAC address, %p product name

- ▶ Mode: Privileged Exec Mode
- ▶ Privilege Level: Operator
- ▶ Format: cli prompt <P-1>

| Parameter | Value | Meaning |
|-----------|--------|---|
| P-1 | string | Enter a user-defined text, max. 128 characters. Following wildcards are allowed: %d date, %t time, %i IP address, %m MAC address, %p product name |

7.1.3 cli numlines

Screen size for 'more' (23 = default). Enter a 0 will disable the feature. The value is only valid for the current session.

- ▶ Mode: Command is in all modes available.
- ▶ Privilege Level: Guest
- ▶ Format: cli numlines <P-1>

| Parameter | Value | Meaning |
|-----------|--------|---|
| P-1 | 0..250 | Screen size for 'more' (23 = default). Enter a 0 will disable the feature. The value is only valid for the current session. |

7.1.4 cli banner operation

Enable or disable the CLI login banner.

- ▶ Mode: Privileged Exec Mode
- ▶ Privilege Level: Administrator
- ▶ Format: cli banner operation

■ no cli banner operation

Disable the option

- ▶ Mode: Privileged Exec Mode
- ▶ Privilege Level: Administrator
- ▶ Format: no cli banner operation

7.1.5 cli banner text

Set the text for the CLI login banner (C printf format syntax allowed: \n \t).

- ▶ Mode: Privileged Exec Mode
- ▶ Privilege Level: Administrator
- ▶ Format: cli banner text <P-1>

| Parameter | Value | Meaning |
|-----------|--------|--|
| P-1 | string | Enter a user-defined text, max. 1024 characters (allowed characters are from ASCII 32 to 127). |

7.2 show

Display device options and settings.

7.2.1 show cli global

Display CLI preferences.

- ▶ Mode: Command is in all modes available.
- ▶ Privilege Level: Guest
- ▶ Format: show cli global

7.2.2 show cli command-tree

Show a list of all commands.

- ▶ Mode: Command is in all modes available.
- ▶ Privilege Level: Guest
- ▶ Format: show cli command-tree

7.3 logging

Logging configuration.

7.3.1 logging cli-command

Enable or disable the CLI command logging.

- ▶ **Mode:** Global Config Mode
- ▶ **Privilege Level:** Administrator
- ▶ **Format:** logging cli-command

■ **no logging cli-command**

Disable the option

- ▶ **Mode:** Global Config Mode
- ▶ **Privilege Level:** Administrator
- ▶ **Format:** no logging cli-command

7.4 show

Display device options and settings.

7.4.1 show logging cli-command

Show the CLI command logging preferences.

- ▶ **Mode:** Command is in all modes available.
- ▶ **Privilege Level:** Guest
- ▶ **Format:** show logging cli-command

8 Clock

8.1 clock

Configure local and DST clock settings.

8.1.1 clock set

Edit current local time.

- ▶ Mode: Global Config Mode
- ▶ Privilege Level: Administrator
- ▶ Format: clock set <P-1> <P-2>

| Parameter | Value | Meaning |
|-----------|------------|--|
| P-1 | YYYY-MM-DD | Local date (range: 2004-01-01 - 2037-12-31). |
| P-2 | HH:MM:SS | Local time. |

8.1.2 clock timezone offset

Local time offset (in minutes) with respect to UTC (positive values for locations east of Greenwich).

- ▶ Mode: Global Config Mode
- ▶ Privilege Level: Administrator
- ▶ Format: clock timezone offset <P-1>

| Parameter | Value | Meaning |
|-----------|-----------|--|
| P-1 | -780..840 | Edit the timezone offset (in minutes). |

8.1.3 clock timezone zone

Edit the timezone acronym (max. 4 characters).

- ▶ Mode: Global Config Mode
- ▶ Privilege Level: Administrator
- ▶ Format: clock timezone zone <P-1>

| Parameter | Value | Meaning |
|-----------|--------|---|
| P-1 | string | Edit the timezone acronym (max 4 characters). |

8.1.4 clock summer-time mode

Configure summer-time mode parameters.

- ▶ Mode: Global Config Mode
- ▶ Privilege Level: Administrator
- ▶ Format: clock summer-time mode <P-1>

| Parameter | Value | Meaning |
|-----------|-----------|--|
| P-1 | disable | Disable recurring summer-time mode. |
| | recurring | Enable recurring summer-time mode. |
| | eu | Enable recurring summer-time used in most parts of the European Union. |
| | usa | Enable recurring summer-time used in most parts of the USA. |

8.1.5 clock summer-time recurring start

Edit the starting date and time for daylight saving time.

- ▶ Mode: Global Config Mode
- ▶ Privilege Level: Administrator
- ▶ Format: clock summer-time recurring start <P-1> <P-2> <P-3> <P-4>

| Parameter | Value | Meaning |
|-----------|----------|---|
| P-1 | none | |
| | first | |
| | second | |
| | third | |
| | fourth | |
| | last | |
| P-2 | none | |
| | sun | Sunday |
| | mon | Monday |
| | tue | Tuesday |
| | wed | Wednesday |
| | thu | Thursday |
| | fri | Friday |
| sat | Saturday | |
| P-3 | none | |
| | jan | January |
| | feb | February |
| | mar | March |
| | apr | April |
| | may | May |
| | jun | June |
| | jul | July |
| | aug | August |
| | sep | September |
| | oct | October |
| | nov | November |
| dec | December | |
| P-4 | string | <hh:mm> Present time in hh:mm format (00:00-23:59). |

8.1.6 clock summer-time recurring end

Edit the ending date and time for daylight saving time.

- ▶ Mode: Global Config Mode
- ▶ Privilege Level: Administrator
- ▶ Format: clock summer-time recurring end <P-1> <P-2> <P-3> <P-4>

| Parameter | Value | Meaning |
|-----------|----------|---|
| P-1 | none | |
| | first | |
| | second | |
| | third | |
| | fourth | |
| | last | |
| | P-2 | none |
| sun | | Sunday |
| mon | | Monday |
| tue | | Tuesday |
| wed | | Wednesday |
| thu | | Thursday |
| fri | | Friday |
| sat | Saturday | |
| P-3 | none | |
| | jan | January |
| | feb | February |
| | mar | March |
| | apr | April |
| | may | May |
| | jun | June |
| | jul | July |
| | aug | August |
| | sep | September |
| | oct | October |
| | nov | November |
| dec | December | |
| P-4 | string | <hh:mm> Present time in hh:mm format (00:00-23:59). |

8.1.7 clock summer-time zone

Edit timezone acronym for summer-time (max. 4 characters).

- ▶ Mode: Global Config Mode
- ▶ Privilege Level: Administrator
- ▶ Format: clock summer-time zone <P-1>

| Parameter | Value | Meaning |
|-----------|--------|---|
| P-1 | string | Edit the timezone acronym (max 4 characters). |

8.2 show

Display device options and settings.

8.2.1 show clock

Display the current time information.

- ▶ **Mode:** Command is in all modes available.
- ▶ **Privilege Level:** Guest
- ▶ **Format:** show clock [summer-time]
[summer-time]: Display summer-time parameters.

9 Configuration

9.1 save

Save the configuration to the specified destination.

9.1.1 save profile

Save the configuration to the specific profile.

- ▶ Mode: All Privileged Modes
- ▶ Privilege Level: Operator
- ▶ Format: save profile <P-1>

| Parameter | Value | Meaning |
|-----------|--------|--|
| P-1 | string | Enter a user-defined text, max. 32 characters. |

9.2 config

Configure the configuration saving settings.

9.2.1 config watchdog admin-state

Enable or disable the configuration undo feature.

- ▶ Mode: Global Config Mode
- ▶ Privilege Level: Operator
- ▶ Format: config watchdog admin-state

■ no config watchdog admin-state

Disable the option

- ▶ Mode: Global Config Mode
- ▶ Privilege Level: Operator
- ▶ Format: no config watchdog admin-state

9.2.2 config watchdog timeout

Configure the configuration undo timeout (unit: seconds).

- ▶ Mode: Global Config Mode
- ▶ Privilege Level: Operator
- ▶ Format: config watchdog timeout <P-1>

| Parameter | Value | Meaning |
|-----------|---------|------------------------------------|
| P-1 | 30..600 | Enter a number in the given range. |

9.2.3 config encryption password set

Set the configuration file password.

- ▶ Mode: Global Config Mode
- ▶ Privilege Level: Administrator
- ▶ Format: config encryption password set [<P-1>] [<P-2>]

| Parameter | Value | Meaning |
|-----------|--------|--|
| P-1 | string | Enter a user-defined text, max. 64 characters. |
| P-2 | string | Enter a user-defined text, max. 64 characters. |

9.2.4 config encryption password clear

Clear the configuration file password.

- ▶ Mode: Global Config Mode
- ▶ Privilege Level: Administrator
- ▶ Format: config encryption password clear [<P-1>]

| Parameter | Value | Meaning |
|-----------|--------|--|
| P-1 | string | Enter a user-defined text, max. 64 characters. |

9.2.5 config envm auto-update

Allow automatic firmware updates with this memory device.

- ▶ Mode: Global Config Mode
- ▶ Privilege Level: Administrator
- ▶ Format: config envm auto-update <P-1>

| Parameter | Value | Meaning |
|-----------|-------|--------------------|
| P-1 | sd | SD-Card |
| | usb | USB Storage Device |

■ no config envm auto-update

Disable the option

- ▶ Mode: Global Config Mode
- ▶ Privilege Level: Administrator
- ▶ Format: no config envm auto-update <P-1>

9.2.6 config envm sshkey-auto-update

Allow automatic ssh key updates with this memory device.

- ▶ Mode: Global Config Mode
- ▶ Privilege Level: Administrator
- ▶ Format: config envm sshkey-auto-update <P-1>

| Parameter | Value | Meaning |
|-----------|-------|--------------------|
| P-1 | sd | SD-Card |
| | usb | USB Storage Device |

■ no config envm sshkey-auto-update

Disable the option

- ▶ Mode: Global Config Mode
- ▶ Privilege Level: Administrator
- ▶ Format: no config envm sshkey-auto-update <P-1>

9.2.7 config envm config-save

Allow the configuration to be saved to this memory device.

- ▶ Mode: Global Config Mode
- ▶ Privilege Level: Operator
- ▶ Format: config envm config-save <P-1>

| Parameter | Value | Meaning |
|-----------|-------|--------------------|
| P-1 | sd | SD-Card |
| | usb | USB Storage Device |

■ no config envm config-save

Disable the option

- ▶ Mode: Global Config Mode
- ▶ Privilege Level: Operator
- ▶ Format: no config envm config-save <P-1>

9.2.8 config envm load-priority

Configure the order of configuration load attempts from memory devices at boot time. If one load is successful, then the device discards further attempts.

- ▶ Mode: Global Config Mode
- ▶ Privilege Level: Operator
- ▶ Format: config envm load-priority <P-1> <P-2>

| Parameter | Value | Meaning |
|-----------|---------|--|
| P-1 | sd | SD-Card |
| | usb | USB Storage Device |
| P-2 | disable | Config will not be loaded at all |
| | first | Config will be loaded first. If successful, no other config will be tried. |
| | second | Config will be loaded if first one does not succeed. |

9.2.9 config envm usb-compatibility

Changes the USB compatibility mode. The changes take effect only after saving the settings and rebooting the device.

- ▶ Mode: Global Config Mode
- ▶ Privilege Level: Operator
- ▶ Format: config envm usb-compatibility <P-1>

| Parameter | Value | Meaning |
|-----------|---------------|--------------------|
| P-1 | normal | Normal Mode |
| | compatibility | Compatibility Mode |

■ no config envm usb-compatibility

Disable the option

- ▶ Mode: Global Config Mode
- ▶ Privilege Level: Operator
- ▶ Format: no config envm usb-compatibility <P-1>

9.2.10 config profile select

Select a configuration profile to be the active configuration.

- ▶ Mode: Global Config Mode
- ▶ Privilege Level: Administrator
- ▶ Format: config profile select <P-1> <P-2>

| Parameter | Value | Meaning |
|-----------|-------|---|
| P-1 | nvm | You can only select nvm for this command. |
| P-2 | 1..20 | Index of the profile entry. |

9.2.11 config profile delete

Delete a specific configuration profile.

- ▶ Mode: Global Config Mode
- ▶ Privilege Level: Administrator
- ▶ Format: `config profile delete <P-1> num <P-2> profile <P-3>`
 num: Select the index of a profile to delete.
 profile: Select the name of a profile to delete.

| Parameter | Value | Meaning |
|-----------|--------|--|
| P-1 | nvm | non-volatile memory |
| | envm | external non-volatile memory device |
| P-2 | 1..20 | Index of the profile entry. |
| P-3 | string | Enter a user-defined text, max. 32 characters. |

9.2.12 config fingerprint verify

Verify the fingerprint of the selected profile.

- ▶ Mode: Global Config Mode
- ▶ Privilege Level: Administrator
- ▶ Format: `config fingerprint verify <P-1> profile <P-2> <P-3> num <P-4> <P-5>`
 profile: Select the name of a profile to be verified.
 num: Select the index number of a profile to be verified.

| Parameter | Value | Meaning |
|-----------|--------|--|
| P-1 | nvm | non-volatile memory |
| | envm | external non-volatile memory device |
| P-2 | string | Enter a user-defined text, max. 32 characters. |
| P-3 | string | Enter hash as 40 hexa-decimal characters. |
| P-4 | 1..20 | Index of the profile entry. |
| P-5 | string | Enter hash as 40 hexa-decimal characters. |

9.3 copy

Copy different kinds of items.

9.3.1 copy sysinfo system envm

Copy the system information to external non-volatile memory.

▶ Mode: Privileged Exec Mode

▶ Privilege Level: Operator

▶ Format: copy sysinfo system envm [filename <P-1>]

[filename]: Enter the filename (format xyz.html) to be saved in external non-volatile memory.

| Parameter | Value | Meaning |
|-----------|--------|--|
| P-1 | string | Enter a user-defined text, max. 32 characters. |

9.3.2 copy sysinfoall system envm

Copy the system information and the event log from the device to external non-volatile memory.

▶ Mode: Privileged Exec Mode

▶ Privilege Level: Operator

▶ Format: copy sysinfoall system envm

9.3.3 copy firmware envm

Copy a firmware image to the device from external non-volatile memory.

▶ Mode: Privileged Exec Mode

▶ Privilege Level: Administrator

▶ Format: copy firmware envm <P-1> system

system: Copy a firmware image to the device from external non-volatile memory.

| Parameter | Value | Meaning |
|-----------|--------|-----------|
| P-1 | string | Filename. |

9.3.4 copy firmware remote

Copy a firmware image to the device from a server.

- ▶ Mode: Privileged Exec Mode
- ▶ Privilege Level: Administrator
- ▶ Format: copy firmware remote <P-1> system

system: Copy a firmware image to the device from a file server.

| Parameter | Value | Meaning |
|-----------|--------|---|
| P-1 | string | Enter a user-defined text, max. 128 characters. |

9.3.5 copy config running-config nvm

Copy the running-config to non-volatile memory.

- ▶ Mode: Privileged Exec Mode
- ▶ Privilege Level: Operator
- ▶ Format: copy config running-config nvm [profile <P-1>]
[profile]: Save the configuration as a specific profile name.

| Parameter | Value | Meaning |
|-----------|--------|--|
| P-1 | string | Enter a user-defined text, max. 32 characters. |

9.3.6 copy config running-config remote

Copy the running-config to a file server.

- ▶ Mode: Privileged Exec Mode
- ▶ Privilege Level: Administrator
- ▶ Format: copy config running-config remote <P-1>

| Parameter | Value | Meaning |
|-----------|--------|---|
| P-1 | string | Enter a user-defined text, max. 128 characters. |

9.3.7 copy config nvm

Load a configuration from non-volatile memory to the running-config.

▶ **Mode:** Privileged Exec Mode

▶ **Privilege Level:** Administrator

▶ **Format:** copy config nvm [profile <P-1>] running-config remote <P-2>

[profile]: Load a configuration from a specific profile name.

running-config: (Re)-load a configuration from non-volatile memory to the running-config.

remote: Copy a configuration from non-volatile memory to a server.

| Parameter | Value | Meaning |
|-----------|--------|---|
| P-1 | string | Filename. |
| P-2 | string | Enter a user-defined text, max. 128 characters. |

9.3.8 copy config envm

Copy a configuration from external non-volatile memory to non-volatile memory.

▶ **Mode:** Privileged Exec Mode

▶ **Privilege Level:** Administrator

▶ **Format:** copy config envm [profile <P-1>] nvm

[profile]: Copy a specific configuration profile from external non-volatile memory to non-volatile memory.

nvm: Copy a specific profile from external non-volatile memory to non-volatile memory.

| Parameter | Value | Meaning |
|-----------|--------|-----------|
| P-1 | string | Filename. |

9.3.9 copy config remote

Copy a configuration file to the device from a server.

▶ **Mode:** Privileged Exec Mode

▶ **Privilege Level:** Administrator

▶ **Format:** copy config remote <P-1> nvm [profile <P-2>] running-config

nvm: Copy a configuration file from a server to non-volatile memory.

[profile]: Copy a configuration from a server to a specific profile in non-volatile memory.

running-config: Copy a configuration file from a server to the running-config.

| Parameter | Value | Meaning |
|-----------|--------|---|
| P-1 | string | Enter a user-defined text, max. 128 characters. |
| P-2 | string | Enter a user-defined text, max. 32 characters. |

9.3.10 copy sfp-white-list remote

Copy the SFP WhiteList from server to the device.

- ▶ Mode: Privileged Exec Mode
- ▶ Privilege Level: Operator
- ▶ Format: copy sfp-white-list remote <P-1> nvm

nvm: Copy the SFP WhiteList from server to the device.

| Parameter | Value | Meaning |
|-----------|--------|---|
| P-1 | string | Enter a user-defined text, max. 128 characters. |

9.3.11 copy sfp-white-list envm

Copy the SFP WhiteList from external non-volatile memory.

- ▶ Mode: Privileged Exec Mode
- ▶ Privilege Level: Operator
- ▶ Format: copy sfp-white-list envm <P-1> nvm

nvm: Copy the SFP WhiteList from external non-volatile memory to the device.

| Parameter | Value | Meaning |
|-----------|--------|---|
| P-1 | string | Enter a user-defined text, max. 128 characters. |

9.4 clear

Clear several items.

9.4.1 clear config

Clear the running configuration.

- ▶ Mode: Privileged Exec Mode
- ▶ Privilege Level: Administrator
- ▶ Format: clear config

9.4.2 clear factory

Set the device back to the factory settings (use with care).

- ▶ Mode: Privileged Exec Mode
 - ▶ Privilege Level: Administrator
 - ▶ Format: clear factory [erase-all]
- [erase-all]: Set to factory settings and also erase file systems (use with extreme care).

9.4.3 clear sfp-white-list

Clear the SFP WhiteList.

- ▶ Mode: Privileged Exec Mode
- ▶ Privilege Level: Operator
- ▶ Format: clear sfp-white-list

9.5 show

Display device options and settings.

9.5.1 show running-config xml

Show the currently running configuration (XML file).

- ▶ **Mode:** Command is in all modes available.
- ▶ **Privilege Level:** Administrator
- ▶ **Format:** `show running-config xml`

9.5.2 show running-config script

Show the currently running configuration (CLI script).

- ▶ **Mode:** Command is in all modes available.
- ▶ **Privilege Level:** Administrator
- ▶ **Format:** `show running-config script [all]`
[all]: Show the currently running configuration (CLI script).

9.6 show

Display device options and settings.

9.6.1 show config envm settings

Show the settings of the external non-volatile memory.

- ▶ Mode: Command is in all modes available.
- ▶ Privilege Level: Guest
- ▶ Format: show config envm settings

9.6.2 show config envm properties

Show the properties of the external non-volatile memory.

- ▶ Mode: Command is in all modes available.
- ▶ Privilege Level: Guest
- ▶ Format: show config envm properties

9.6.3 show config envm usb-compatibility

Show the USB compatibility mode. The admin mode takes effect after saving the settings and rebooting the device.

- ▶ Mode: Command is in all modes available.
- ▶ Privilege Level: Guest
- ▶ Format: show config envm usb-compatibility

9.6.4 show config watchdog

Show the Auto Configuration Undo settings.

- ▶ Mode: Command is in all modes available.
- ▶ Privilege Level: Guest
- ▶ Format: show config watchdog

9.6.5 show config encryption

Show the settings for config encryption.

- ▶ Mode: Command is in all modes available.
- ▶ Privilege Level: Guest
- ▶ Format: show config encryption

9.6.6 show config profiles

Show the configuration profiles.

- ▶ Mode: Command is in all modes available.
- ▶ Privilege Level: Administrator
- ▶ Format: show config profiles <P-1> [<P-2>]

| Parameter | Value | Meaning |
|-----------|-------|-------------------------------------|
| P-1 | nvm | non-volatile memory |
| | envm | external non-volatile memory device |
| P-2 | 1..20 | Index of the profile entry. |

9.6.7 show config status

Show the sync status of the running-config with non-volatile memory and ACA.

- ▶ Mode: Command is in all modes available.
- ▶ Privilege Level: Guest
- ▶ Format: show config status

9.7 swap

Swap software images.

9.7.1 swap firmware system backup

Swap the main and backup images.

- ▶ Mode: Privileged Exec Mode
- ▶ Privilege Level: Administrator
- ▶ Format: swap firmware system backup

10 Debugging

10.1 debug

Different tools to assist in debugging the device.

10.1.1 debug tcpdump help

Display help file for the tcpdump tool.

- ▶ Mode: Privileged Exec Mode
- ▶ Privilege Level: Operator
- ▶ Format: debug tcpdump help

10.1.2 debug tcpdump start cpu

Start capture with default values.

- ▶ Mode: Privileged Exec Mode
 - ▶ Privilege Level: Operator
 - ▶ Format: debug tcpdump start cpu [filter <P-1>] [parms <P-2>]
- [filter]: Start capture with values from a filter file.
[parms]: Start capture with the tcpdump parameters (for details see tcpdump help).

| Parameter | Value | Meaning |
|-----------|--------|---|
| P-1 | string | <filename> Enter a valid filename. |
| P-2 | string | Enter a user-defined text, max. 255 characters. |

10.1.3 debug tcpdump stop

Abort capture of network traffic.

- ▶ Mode: Privileged Exec Mode
- ▶ Privilege Level: Operator
- ▶ Format: debug tcpdump stop

10.1.4 debug tcpdump filter show

Display a known filter file.

- ▶ Mode: Privileged Exec Mode
- ▶ Privilege Level: Operator
- ▶ Format: debug tcpdump filter show <P-1>

| Parameter | Value | Meaning |
|-----------|--------|------------------------------------|
| P-1 | string | <filename> Enter a valid filename. |

10.1.5 debug tcpdump filter list

Display all available filter files.

- ▶ Mode: Privileged Exec Mode
- ▶ Privilege Level: Operator
- ▶ Format: debug tcpdump filter list

10.1.6 debug tcpdump filter delete

Delete a known filter file.

- ▶ Mode: Privileged Exec Mode
- ▶ Privilege Level: Operator
- ▶ Format: debug tcpdump filter delete <P-1>

| Parameter | Value | Meaning |
|-----------|--------|------------------------------------|
| P-1 | string | <filename> Enter a valid filename. |

10.2 show

Display device options and settings.

10.2.1 show debug logic-modules

List logic module information

- ▶ Mode: Privileged Exec Mode
- ▶ Privilege Level: Administrator
- ▶ Format: show debug logic-modules

10.3 copy

Copy different kinds of items.

10.3.1 copy tcpdumpcap nvm envm

Copy the capture file from non-volatile memory to external non-volatile memory.

- ▶ Mode: Privileged Exec Mode
- ▶ Privilege Level: Operator
- ▶ Format: copy tcpdumpcap nvm envm [<P-1>]

| Parameter | Value | Meaning |
|-----------|--------|------------------------------------|
| P-1 | string | <filename> Enter a valid filename. |

10.3.2 copy tcpdumpcap nvm remote

Copy the capture file from the device to a server.

- ▶ Mode: Privileged Exec Mode
- ▶ Privilege Level: Operator
- ▶ Format: copy tcpdumpcap nvm remote <P-1>

| Parameter | Value | Meaning |
|-----------|--------|---|
| P-1 | string | Enter a user-defined text, max. 128 characters. |

10.3.3 copy tcpdumpfilter remote

Copy the filter file from a server to the specified destination.

- ▶ Mode: Privileged Exec Mode
 - ▶ Privilege Level: Operator
 - ▶ Format: copy tcpdumpfilter remote <P-1> nvm <P-2>
- nvm: Copy the filter file from a server to non-volatile memory.

| Parameter | Value | Meaning |
|-----------|--------|---|
| P-1 | string | Enter a user-defined text, max. 128 characters. |

| Parameter | Value | Meaning |
|-----------|--------|------------------------------------|
| P-2 | string | <filename> Enter a valid filename. |

10.3.4 copy tcpdumpfilter envm

Copy the capture filter from external non-volatile memory to the specified destination.

- ▶ Mode: Privileged Exec Mode
- ▶ Privilege Level: Operator
- ▶ Format: `copy tcpdumpfilter envm <P-1> nvm [<P-2>]`

nvm: Copy the capture filter from external non-volatile memory to non-volatile memory.

| Parameter | Value | Meaning |
|-----------|--------|------------------------------------|
| P-1 | string | <filename> Enter a valid filename. |
| P-2 | string | <filename> Enter a valid filename. |

10.3.5 copy tcpdumpfilter nvm

Copy the capture filter from non-volatile memory to the specified destination.

- ▶ Mode: Privileged Exec Mode
- ▶ Privilege Level: Operator
- ▶ Format: `copy tcpdumpfilter nvm <P-1> envm [<P-2>] remote <P-3>`

envm: Copy the capture filter from non-volatile memory to external non-volatile memory.

remote: Copy the capture file from non-volatile memory to a server.

| Parameter | Value | Meaning |
|-----------|--------|---|
| P-1 | string | Filename. |
| P-2 | string | <filename> Enter a valid filename. |
| P-3 | string | Enter a user-defined text, max. 128 characters. |

11 Device Monitoring

11.1 device-status

Configure various device conditions to be monitored.

11.1.1 device-status monitor link-failure

Enable or disable monitor state of network connection(s).

- ▶ Mode: Global Config Mode
- ▶ Privilege Level: Administrator
- ▶ Format: device-status monitor link-failure

■ no device-status monitor link-failure

Disable the option

- ▶ Mode: Global Config Mode
- ▶ Privilege Level: Administrator
- ▶ Format: no device-status monitor link-failure

11.1.2 device-status monitor temperature

Enable or disable monitoring of the device temperature.

- ▶ Mode: Global Config Mode
- ▶ Privilege Level: Administrator
- ▶ Format: device-status monitor temperature

■ no device-status monitor temperature

Disable the option

- ▶ Mode: Global Config Mode
- ▶ Privilege Level: Administrator
- ▶ Format: no device-status monitor temperature

11.1.3 device-status monitor envm-removal

Enable or disable monitoring the presence of the external non-volatile memory.

- ▶ Mode: Global Config Mode
- ▶ Privilege Level: Administrator
- ▶ Format: device-status monitor envm-removal

■ no device-status monitor envm-removal

Disable the option

- ▶ Mode: Global Config Mode
- ▶ Privilege Level: Administrator
- ▶ Format: no device-status monitor envm-removal

11.1.4 device-status monitor envm-not-in-sync

Enable or disable monitoring synchronization between the external non-volatile memory and the running configuration.

- ▶ Mode: Global Config Mode
- ▶ Privilege Level: Administrator
- ▶ Format: device-status monitor envm-not-in-sync

■ no device-status monitor envm-not-in-sync

Disable the option

- ▶ Mode: Global Config Mode
- ▶ Privilege Level: Administrator
- ▶ Format: no device-status monitor envm-not-in-sync

11.1.5 device-status monitor ring-redundancy

Enable or disable monitoring if ring-redundancy is present.

- ▶ Mode: Global Config Mode
- ▶ Privilege Level: Administrator
- ▶ Format: device-status monitor ring-redundancy

■ **no device-status monitor ring-redundancy**

Disable the option

- ▶ **Mode:** Global Config Mode
- ▶ **Privilege Level:** Administrator
- ▶ **Format:** no device-status monitor ring-redundancy

11.1.6 device-status monitor power-supply

Enable or disable monitoring the condition of the power supply(s).

- ▶ **Mode:** Global Config Mode
- ▶ **Privilege Level:** Administrator
- ▶ **Format:** device-status monitor power-supply <P-1>

| Parameter | Value | Meaning |
|-----------|-------|-------------------------|
| P-1 | 1..2 | Number of power supply. |

■ **no device-status monitor power-supply**

Disable the option

- ▶ **Mode:** Global Config Mode
- ▶ **Privilege Level:** Administrator
- ▶ **Format:** no device-status monitor power-supply <P-1>

11.1.7 device-status trap

Configure the device to send a trap when the device status changes.

- ▶ **Mode:** Global Config Mode
- ▶ **Privilege Level:** Administrator
- ▶ **Format:** device-status trap

■ **no device-status trap**

Disable the option

- ▶ **Mode:** Global Config Mode
- ▶ **Privilege Level:** Administrator
- ▶ **Format:** no device-status trap

11.2 device-status

Configure various device conditions to be monitored.

11.2.1 device-status link-alarm

Configure the monitor settings of the port link.

- ▶ **Mode:** Interface Range Mode
- ▶ **Privilege Level:** Administrator
- ▶ **Format:** device-status link-alarm

■ **no device-status link-alarm**

Disable the option

- ▶ **Mode:** Interface Range Mode
- ▶ **Privilege Level:** Administrator
- ▶ **Format:** no device-status link-alarm

11.3 show

Display device options and settings.

11.3.1 show device-status monitor

Display the device monitoring configurations.

- ▶ Mode: Command is in all modes available.
- ▶ Privilege Level: Guest
- ▶ Format: show device-status monitor

11.3.2 show device-status state

Display the current state of the device.

- ▶ Mode: Command is in all modes available.
- ▶ Privilege Level: Guest
- ▶ Format: show device-status state

11.3.3 show device-status trap

Display the device trap information and configurations.

- ▶ Mode: Command is in all modes available.
- ▶ Privilege Level: Guest
- ▶ Format: show device-status trap

11.3.4 show device-status events

Display occurred device status events.

- ▶ Mode: Command is in all modes available.
- ▶ Privilege Level: Guest
- ▶ Format: show device-status events

11.3.5 show device-status link-alarm

Display the monitor configurations of the network ports.

- ▶ Mode: Command is in all modes available.
- ▶ Privilege Level: Guest
- ▶ Format: show device-status link-alarm

11.3.6 show device-status all

Display the configurable device status settings.

- ▶ Mode: Command is in all modes available.
- ▶ Privilege Level: Guest
- ▶ Format: show device-status all

12 Device Security

12.1 security-status

Configure the security status settings.

12.1.1 security-status monitor pwd-change

Sets the monitoring of default password change for 'user' and 'admin'.

- ▶ Mode: Global Config Mode
- ▶ Privilege Level: Administrator
- ▶ Format: security-status monitor pwd-change

■ no security-status monitor pwd-change

Disable the option

- ▶ Mode: Global Config Mode
- ▶ Privilege Level: Administrator
- ▶ Format: no security-status monitor pwd-change

12.1.2 security-status monitor pwd-min-length

Sets the monitoring of minimum length of the password (smaller 8).

- ▶ Mode: Global Config Mode
- ▶ Privilege Level: Administrator
- ▶ Format: security-status monitor pwd-min-length

■ no security-status monitor pwd-min-length

Disable the option

- ▶ Mode: Global Config Mode
- ▶ Privilege Level: Administrator
- ▶ Format: no security-status monitor pwd-min-length

12.1.3 security-status monitor pwd-policy-config

Sets the monitoring whether the minimum password policy is configured. The device changes the security status to the value "error" if the value for at least one of the following password rules is 0:\n"minimum upper cases", "minimum lower cases", "minimum numbers", "minimum special characters".

- ▶ Mode: Global Config Mode
- ▶ Privilege Level: Administrator
- ▶ Format: security-status monitor pwd-policy-config

■ no security-status monitor pwd-policy-config

Disable the option

- ▶ Mode: Global Config Mode
- ▶ Privilege Level: Administrator
- ▶ Format: no security-status monitor pwd-policy-config

12.1.4 security-status monitor pwd-str-not-config

Sets the monitoring whether the password minimum\nstrength check is configured.

- ▶ Mode: Global Config Mode
- ▶ Privilege Level: Administrator
- ▶ Format: security-status monitor pwd-str-not-config

■ no security-status monitor pwd-str-not-config

Disable the option

- ▶ Mode: Global Config Mode
- ▶ Privilege Level: Administrator
- ▶ Format: no security-status monitor pwd-str-not-config

12.1.5 security-status monitor pwd-policy-inactive

Sets the monitoring whether at least one user is\nconfigured with inactive policy check.\nThe device changes the security status to the value "error" if the function "policy check" is inactive for at least 1 user account.

- ▶ Mode: Global Config Mode
- ▶ Privilege Level: Administrator
- ▶ Format: security-status monitor pwd-policy-inactive

■ **no security-status monitor pwd-policy-inactive**

Disable the option

- ▶ Mode: Global Config Mode
- ▶ Privilege Level: Administrator
- ▶ Format: no security-status monitor pwd-policy-inactive

12.1.6 security-status monitor bypass-pwd-strength

Sets the monitoring whether at least one user is configured to bypass strength check.

- ▶ Mode: Global Config Mode
- ▶ Privilege Level: Administrator
- ▶ Format: security-status monitor bypass-pwd-strength

■ **no security-status monitor bypass-pwd-strength**

Disable the option

- ▶ Mode: Global Config Mode
- ▶ Privilege Level: Administrator
- ▶ Format: no security-status monitor bypass-pwd-strength

12.1.7 security-status monitor telnet-enabled

Sets the monitoring of the activation of telnet on the switch.

- ▶ Mode: Global Config Mode
- ▶ Privilege Level: Administrator
- ▶ Format: security-status monitor telnet-enabled

■ **no security-status monitor telnet-enabled**

Disable the option

- ▶ Mode: Global Config Mode
- ▶ Privilege Level: Administrator
- ▶ Format: no security-status monitor telnet-enabled

12.1.8 security-status monitor http-enabled

Sets the monitoring of the activation of http on the switch.

- ▶ Mode: Global Config Mode
- ▶ Privilege Level: Administrator
- ▶ Format: security-status monitor http-enabled

■ no security-status monitor http-enabled

Disable the option

- ▶ Mode: Global Config Mode
- ▶ Privilege Level: Administrator
- ▶ Format: no security-status monitor http-enabled

12.1.9 security-status monitor snmp-unsecure

Sets the monitoring of SNMP security\n(SNMP v1/v2 is enabled or v3 encryption is disabled).

- ▶ Mode: Global Config Mode
- ▶ Privilege Level: Administrator
- ▶ Format: security-status monitor snmp-unsecure

■ no security-status monitor snmp-unsecure

Disable the option

- ▶ Mode: Global Config Mode
- ▶ Privilege Level: Administrator
- ▶ Format: no security-status monitor snmp-unsecure

12.1.10 security-status monitor sysmon-enabled

Sets the monitoring of the activation of System Monitor 1 on the switch.

- ▶ Mode: Global Config Mode
- ▶ Privilege Level: Administrator
- ▶ Format: security-status monitor sysmon-enabled

■ **no security-status monitor sysmon-enabled**

Disable the option

- ▶ Mode: Global Config Mode
- ▶ Privilege Level: Administrator
- ▶ Format: no security-status monitor sysmon-enabled

12.1.11 security-status monitor extnvm-upd-enabled

Sets the monitoring of activation of the configuration\n saving to external non volatile memory.

- ▶ Mode: Global Config Mode
- ▶ Privilege Level: Administrator
- ▶ Format: security-status monitor extnvm-upd-enabled

■ **no security-status monitor extnvm-upd-enabled**

Disable the option

- ▶ Mode: Global Config Mode
- ▶ Privilege Level: Administrator
- ▶ Format: no security-status monitor extnvm-upd-enabled

12.1.12 security-status monitor no-link-enabled

Sets the monitoring of no link detection.

- ▶ Mode: Global Config Mode
- ▶ Privilege Level: Administrator
- ▶ Format: security-status monitor no-link-enabled

■ **no security-status monitor no-link-enabled**

Disable the option

- ▶ Mode: Global Config Mode
- ▶ Privilege Level: Administrator
- ▶ Format: no security-status monitor no-link-enabled

12.1.13 security-status monitor hidisc-write-enabled

Sets the monitoring of HiDiscovery write enabled.

- ▶ Mode: Global Config Mode
- ▶ Privilege Level: Administrator
- ▶ Format: security-status monitor hidisc-write-enabled

■ no security-status monitor hidisc-write-enabled

Disable the option

- ▶ Mode: Global Config Mode
- ▶ Privilege Level: Administrator
- ▶ Format: no security-status monitor hidisc-write-enabled

12.1.14 security-status monitor extnvm-load-unsecure

Sets the monitoring of security of the configuration loading from extnvm.

- ▶ Mode: Global Config Mode
- ▶ Privilege Level: Administrator
- ▶ Format: security-status monitor extnvm-load-unsecure

■ no security-status monitor extnvm-load-unsecure

Disable the option

- ▶ Mode: Global Config Mode
- ▶ Privilege Level: Administrator
- ▶ Format: no security-status monitor extnvm-load-unsecure

12.1.15 security-status monitor iec61850-mms-enabled

Sets the monitoring of the activation of IEC 61850 MMS on the switch.

- ▶ Mode: Global Config Mode
- ▶ Privilege Level: Administrator
- ▶ Format: security-status monitor iec61850-mms-enabled

■ **no security-status monitor iec61850-mms-enabled**

Disable the option

- ▶ Mode: Global Config Mode
- ▶ Privilege Level: Administrator
- ▶ Format: no security-status monitor iec61850-mms-enabled

12.1.16 security-status monitor https-certificate

Sets the monitoring whether auto generated self-signed HTTPS certificate is in use.

- ▶ Mode: Global Config Mode
- ▶ Privilege Level: Administrator
- ▶ Format: security-status monitor https-certificate

■ **no security-status monitor https-certificate**

Disable the option

- ▶ Mode: Global Config Mode
- ▶ Privilege Level: Administrator
- ▶ Format: no security-status monitor https-certificate

12.1.17 security-status monitor modbus-tcp-enabled

Sets the monitoring of the activation of Modbus/TCP server on the switch.

- ▶ Mode: Global Config Mode
- ▶ Privilege Level: Administrator
- ▶ Format: security-status monitor modbus-tcp-enabled

■ **no security-status monitor modbus-tcp-enabled**

Disable the option

- ▶ Mode: Global Config Mode
- ▶ Privilege Level: Administrator
- ▶ Format: no security-status monitor modbus-tcp-enabled

12.1.18 security-status monitor ethernet-ip-enabled

Sets the monitoring of the activation of EtherNet/IP protocol on the switch.

- ▶ Mode: Global Config Mode
- ▶ Privilege Level: Administrator
- ▶ Format: security-status monitor ethernet-ip-enabled

■ no security-status monitor ethernet-ip-enabled

Disable the option

- ▶ Mode: Global Config Mode
- ▶ Privilege Level: Administrator
- ▶ Format: no security-status monitor ethernet-ip-enabled

12.1.19 security-status monitor profinet-io-enabled

Sets the monitoring of the activation of PROFINET protocol on the switch.

- ▶ Mode: Global Config Mode
- ▶ Privilege Level: Administrator
- ▶ Format: security-status monitor profinet-io-enabled

■ no security-status monitor profinet-io-enabled

Disable the option

- ▶ Mode: Global Config Mode
- ▶ Privilege Level: Administrator
- ▶ Format: no security-status monitor profinet-io-enabled

12.1.20 security-status trap

Configure if a trap is sent when the security status\nchanges.

- ▶ Mode: Global Config Mode
- ▶ Privilege Level: Administrator
- ▶ Format: security-status trap

■ **no security-status trap**

Disable the option

- ▶ **Mode:** Global Config Mode
- ▶ **Privilege Level:** Administrator
- ▶ **Format:** no security-status trap

12.2 security-status

Configure the security status interface settings.

12.2.1 security-status no-link

Configure the monitoring of the specific ports.

- ▶ Mode: Interface Range Mode
- ▶ Privilege Level: Administrator
- ▶ Format: security-status no-link

■ no security-status no-link

Disable the option

- ▶ Mode: Interface Range Mode
- ▶ Privilege Level: Administrator
- ▶ Format: no security-status no-link

12.3 show

Display device options and settings.

12.3.1 show security-status monitor

Display the security status monitoring settings.

- ▶ Mode: Command is in all modes available.
- ▶ Privilege Level: Guest
- ▶ Format: show security-status monitor

12.3.2 show security-status state

Display the current security status.

- ▶ Mode: Command is in all modes available.
- ▶ Privilege Level: Guest
- ▶ Format: show security-status state

12.3.3 show security-status no-link

Display the settings of the monitoring of the specific network ports.

- ▶ Mode: Command is in all modes available.
- ▶ Privilege Level: Guest
- ▶ Format: show security-status no-link

12.3.4 show security-status trap

Display the security status trap information and settings.

- ▶ Mode: Command is in all modes available.
- ▶ Privilege Level: Guest
- ▶ Format: show security-status trap

12.3.5 show security-status events

Display occurred security status events.

- ▶ Mode: Command is in all modes available.
- ▶ Privilege Level: Guest
- ▶ Format: show security-status events

12.3.6 show security-status all

Display all security status settings.

- ▶ Mode: Command is in all modes available.
- ▶ Privilege Level: Guest
- ▶ Format: show security-status all

13 Dynamic Host Configuration Protocol (DHCP)

13.1 dhcp-server

Modify DHCP Server parameters.

13.1.1 dhcp-server operation

Enable or disable the DHCP server on this port.

- ▶ Mode: Interface Range Mode
- ▶ Privilege Level: Operator
- ▶ Format: dhcp-server operation

■ no dhcp-server operation

Disable the option

- ▶ Mode: Interface Range Mode
- ▶ Privilege Level: Operator
- ▶ Format: no dhcp-server operation

13.2 dhcp-server

Modify DHCP Server parameters.

13.2.1 dhcp-server operation

Enable or disable the DHCP server globally.

- ▶ Mode: Global Config Mode
- ▶ Privilege Level: Operator
- ▶ Format: dhcp-server operation

■ no dhcp-server operation

Disable the option

- ▶ Mode: Global Config Mode
- ▶ Privilege Level: Operator
- ▶ Format: no dhcp-server operation

13.2.2 dhcp-server pool add

Add a pool

- ▶ Mode: Global Config Mode
- ▶ Privilege Level: Operator
- ▶ Format: dhcp-server pool add <P-1> dynamic <P-2> <P-3> static <P-4>

dynamic: Add a dynamic pool (one or more IPs).

static: Add a static pool (one IP).

| Parameter | Value | Meaning |
|-----------|---------|-------------|
| P-1 | 1..128 | Pool ID. |
| P-2 | A.B.C.D | IP address. |
| P-3 | A.B.C.D | IP address. |
| P-4 | A.B.C.D | IP address. |

13.2.3 dhcp-server pool modify

Modify the dynamic address pool

► **Mode:** Global Config Mode

► **Privilege Level:** Operator

► **Format:** dhcp-server pool modify <-1> mode interface <-2> mac <-3> clientid <-4> remoteid <-5> circuitid <-6> relay <-7> vlan <-8> leasetime <-9> option configpath <-10> gateway <-11> netmask <-12> wins <-13> dns <-14> hostname <-15> hhrschsancsashanh-device

mode: Pool mode settings.

interface: Interface mode.

mac: MAC mode.

clientid: Clientid mode.

remoteid: Remoteid mode.

circuitid: Circuitid mode.

relay: Relay mode.

vlan: VLAN mode.

leasetime: Enter the leasetime in seconds.

option: Configuration option.

configpath: Configpath in 'tftp://<servername>/<file>' format.

gateway: Default gateway.

netmask: Option netmask.

wins: Option wins.

dns: Option dns.

hostname: Option hostname.

hhrschsancsashanh-device: Set this pool to HHrschsancsashasnh devices only.

| Parameter | Value | Meaning |
|-----------|-------------------|--|
| P-1 | 1..128 | Pool ID. |
| P-2 | slot no./port no. | |
| P-3 | none | Remove MAC mode. |
| | aa:bb:cc:dd:ee:ff | MAC address. |
| P-4 | none | Remove ID mode. |
| | xx:xx:....:xx | Enter ID in hexadecimal format. |
| P-5 | none | Remove ID mode. |
| | xx:xx:....:xx | Enter ID in hexadecimal format. |
| P-6 | none | Remove ID mode. |
| | xx:xx:....:xx | Enter ID in hexadecimal format. |
| P-7 | none | Remove relay mode. |
| | ipaddr | Enter IP address of the relay. |
| P-8 | -1..4042 | VLAN ID. A value of -1 corresponds to management vlan (the default), any other value (1-4042) represents a specific VLAN |
| P-9 | infinite | Infinite leasetime. |
| | seconds | Leasetime in seconds. |
| P-10 | tftp://s | tftp://<servername>/<file> Configuration path; empty string ("") to clear value. |
| P-11 | A.B.C.D | IP address. |
| P-12 | a.b.c.d | IP subnet mask. |
| P-13 | A.B.C.D | IP address. |
| P-14 | A.B.C.D | IP address. |
| P-15 | string | Enter a user-defined text, max. 64 characters. |

■ **no dhcp-server pool modify**

Disable the option

- ▶ **Mode:** Global Config Mode
- ▶ **Privilege Level:** Operator
- ▶ **Format:** no dhcp-server pool modify mode interface mac clientid remoteid circuitid relay vlan leasetime option configpath gateway netmask wins dns hostname hrschsancsashanhh-device

13.2.4 dhcp-server pool mode

Pool enable.

- ▶ **Mode:** Global Config Mode
- ▶ **Privilege Level:** Operator
- ▶ **Format:** dhcp-server pool mode <P-1>

| Parameter | Value | Meaning |
|-----------|--------|----------|
| P-1 | 1..128 | Pool ID. |

■ **no dhcp-server pool mode**

Disable the option

- ▶ **Mode:** Global Config Mode
- ▶ **Privilege Level:** Operator
- ▶ **Format:** no dhcp-server pool mode <P-1>

13.2.5 dhcp-server pool delete

Pool delete.

- ▶ **Mode:** Global Config Mode
- ▶ **Privilege Level:** Operator
- ▶ **Format:** dhcp-server pool delete <P-1>

| Parameter | Value | Meaning |
|-----------|--------|----------|
| P-1 | 1..128 | Pool ID. |

13.3 show

Display device options and settings.

13.3.1 show dhcp-server operation

Display DHCP Server global information.

- ▶ Mode: Command is in all modes available.
- ▶ Privilege Level: Guest
- ▶ Format: show dhcp-server operation

13.3.2 show dhcp-server pool

Show DHCP Server pool entries.

- ▶ Mode: Command is in all modes available.
- ▶ Privilege Level: Guest
- ▶ Format: show dhcp-server pool [<P-1>]

| Parameter | Value | Meaning |
|-----------|--------|----------|
| P-1 | 1..128 | Pool ID. |

13.3.3 show dhcp-server interface

Show DHCP Server per interface.

- ▶ Mode: Command is in all modes available.
- ▶ Privilege Level: Guest
- ▶ Format: show dhcp-server interface [<P-1>]

| Parameter | Value | Meaning |
|-----------|-------------------|---------|
| P-1 | slot no./port no. | |

13.3.4 show dhcp-server lease

Show DHCP Server lease entries.

- ▶ **Mode:** Command is in all modes available.
- ▶ **Privilege Level:** Guest
- ▶ **Format:** show dhcp-server lease

14 DHCP Layer 2 Relay

14.1 clear

Clear several items.

14.1.1 clear dhcp-l2relay statistics

This command clears the DHCP Layer 2 Relay statistics.

- ▶ Mode: Privileged Exec Mode
- ▶ Privilege Level: Operator
- ▶ Format: `clear dhcp-l2relay statistics`

14.2 show

Display device options and settings.

14.2.1 show dhcp-l2relay global

This command displays the global DHCP Layer 2 Relay configuration.

- ▶ **Mode:** Command is in all modes available.
- ▶ **Privilege Level:** Guest
- ▶ **Format:** show dhcp-l2relay global

14.2.2 show dhcp-l2relay statistics

This command displays interface statistics specific to DHCP Layer 2 Relay.

- ▶ **Mode:** Command is in all modes available.
- ▶ **Privilege Level:** Guest
- ▶ **Format:** show dhcp-l2relay statistics

14.2.3 show dhcp-l2relay interfaces

This command displays the DHCP Layer 2 Relay status of all interfaces.

- ▶ **Mode:** Command is in all modes available.
- ▶ **Privilege Level:** Guest
- ▶ **Format:** show dhcp-l2relay interfaces

14.2.4 show dhcp-l2relay vlan

This command displays the VLAN based DHCP Layer 2 Relay status.

- ▶ **Mode:** Command is in all modes available.
- ▶ **Privilege Level:** Guest
- ▶ **Format:** show dhcp-l2relay vlan

15 DHCP Snooping

15.1 clear

Clear several items.

15.1.1 clear ip dhcp-snooping bindings

This command clears all dynamic DHCP Snooping (and IP Source Guard) bindings on all interfaces or on a specific interface.

- ▶ Mode: Privileged Exec Mode
- ▶ Privilege Level: Operator
- ▶ Format: clear ip dhcp-snooping bindings [<P-1>]

| Parameter | Value | Meaning |
|-----------|-------------------|---------|
| P-1 | slot no./port no. | |

15.1.2 clear ip dhcp-snooping statistics

This command clears the DHCP Snooping statistics.

- ▶ Mode: Privileged Exec Mode
- ▶ Privilege Level: Operator
- ▶ Format: clear ip dhcp-snooping statistics

15.2 show

Display device options and settings.

15.2.1 show ip dhcp-snooping global

This command displays the global DHCP Snooping configuration.

- ▶ **Mode:** Command is in all modes available.
- ▶ **Privilege Level:** Guest
- ▶ **Format:** show ip dhcp-snooping global

15.2.2 show ip dhcp-snooping statistics

This command displays statistics for DHCP Snooping security violations on untrusted ports.

- ▶ **Mode:** Command is in all modes available.
- ▶ **Privilege Level:** Guest
- ▶ **Format:** show ip dhcp-snooping statistics

15.2.3 show ip dhcp-snooping interfaces

This command shows the DHCP Snooping status of all interfaces.

- ▶ **Mode:** Command is in all modes available.
- ▶ **Privilege Level:** Guest
- ▶ **Format:** show ip dhcp-snooping interfaces

15.2.4 show ip dhcp-snooping vlan

This command displays the VLAN based DHCP Snooping status.

- ▶ **Mode:** Command is in all modes available.
- ▶ **Privilege Level:** Guest
- ▶ **Format:** show ip dhcp-snooping vlan

15.2.5 show ip dhcp-snooping bindings

This command displays the DHCP Snooping binding entries from the static and/or dynamic bindings table.

- ▶ **Mode:** Command is in all modes available.
- ▶ **Privilege Level:** Guest
- ▶ **Format:** show ip dhcp-snooping bindings [<P-1>] [interface <P-2>] [vlan <P-3>]
[interface]: Restrict the output based on a specific interface.
[vlan]: Restrict the output based on VLAN.

| Parameter | Value | Meaning |
|-----------|-------------------|--|
| P-1 | static | Restrict the output based on static bindings. |
| | dynamic | Restrict the output based on dynamic bindings. |
| P-2 | slot no./port no. | |
| P-3 | 1..4042 | Enter the VLAN ID. |

16 Device Level Ring (DLR)

16.1 dlr

Set the DLR parameters.

16.1.1 dlr operation

Enable or disable the Device Level Ring globally.

- ▶ **Mode:** Global Config Mode
- ▶ **Privilege Level:** Operator
- ▶ **Format:** dlr operation

■ no dlr operation

Disable the option

- ▶ **Mode:** Global Config Mode
- ▶ **Privilege Level:** Operator
- ▶ **Format:** no dlr operation

16.1.2 dlr ring add

Create a Device Level Ring. The DLR ring will consist of default parameters and its operation will be disabled.

- ▶ **Mode:** Global Config Mode
- ▶ **Privilege Level:** Operator
- ▶ **Format:** dlr ring add <P-1> [port-1 <P-2>] [port-2 <P-3>] [name <P-4>] [supervisor <P-5>] [precedence <P-6>] [vlan <P-7>] [beacon-interval <P-8>] [beacon-timeout <P-9>]

[port-1]: Configure the DLR ring port 1.

[port-2]: Configure the DLR ring port 2.

[name]: Configure the name of the DLR ring.

[supervisor]: Enable or disable the supervisor mode.

[precedence]: Configure the supervisor precedence.

[vlan]: Configure the VLAN identifier to use in the DLR protocol messages.

[beacon-interval]: Configure the beacon interval in microseconds (default: 400).

[beacon-timeout]: Configure the beacon timeout in microseconds (default: 1960).

| Parameter | Value | Meaning |
|-----------|-------------------|------------------|
| P-1 | 1..255 | The DLR ring ID. |
| P-2 | slot no./port no. | |

| Parameter | Value | Meaning |
|-----------|-------------------|--|
| P-3 | slot no./port no. | |
| P-4 | string | Enter a user-defined text, max. 255 characters. |
| P-5 | enable | Enable the option. |
| | disable | Disable the option. |
| P-6 | 0..255 | The DLR supervisor precedence (default: 0). |
| P-7 | 0..4042 | Enter the VLAN ID. Entering of ID 0 disables the feature. |
| P-8 | 400..100000 | The DLR beacon interval time in microseconds (default: 400). |
| P-9 | 1600..500000 | The DLR beacon timeout in microseconds (default: 1960). |

16.1.3 dlr ring delete

Delete the Device Level Ring.

- ▶ Mode: Global Config Mode
- ▶ Privilege Level: Operator
- ▶ Format: `dlr ring delete <P-1>`

| Parameter | Value | Meaning |
|-----------|--------|------------------|
| P-1 | 1..255 | The DLR ring ID. |

16.1.4 dlr ring modify

Modify the DLR ring settings.

- ▶ Mode: Global Config Mode
- ▶ Privilege Level: Operator
- ▶ Format: `dlr ring modify <P-1> operation <P-2> supervisor <P-3> precedence <P-4> name <P-5> port-1 <P-6> port-2 <P-7> beacon interval <P-8> timeout <P-9> vlan <P-10> service <P-11>`

operation: Enable or disable the Device Level Ring for the specified ring ID.

supervisor: Enable or disable the supervisor mode.

precedence: Configure the supervisor precedence.

name: Configure the name of the DLR ring.

port-1: Configure the DLR ring ports.

port-2: Configure the DLR ring ports.

beacon: Configure the beacon interval or the beacon timeout in microseconds.

interval: Configure the beacon interval in microseconds (default: 400).

timeout: Configure the beacon timeout in microseconds (default: 1960).

vlan: Configure the VLAN identifier to use in the DLR protocol messages.

service: Initiates a service on the supervisor node.

| Parameter | Value | Meaning |
|-----------|--------|------------------|
| P-1 | 1..255 | The DLR ring ID. |

Device Level Ring (DLR)

16.1 dlr

| Parameter | Value | Meaning |
|-----------|----------------------------|--|
| P-2 | enable | Enable the option. |
| | disable | Disable the option. |
| P-3 | enable | Enable the option. |
| | disable | Disable the option. |
| P-4 | 0..255 | The DLR supervisor precedence (default: 0). |
| P-5 | string | Enter a user-defined text, max. 255 characters. |
| P-6 | slot no./port no. | |
| P-7 | slot no./port no. | |
| P-8 | 400..100000 | The DLR beacon interval time in microseconds (default: 400). |
| P-9 | 1600..500000 | The DLR beacon timeout in microseconds (default: 1960). |
| P-10 | 0..4042 | Enter the VLAN ID. Entering of ID 0 disables the feature. |
| P-11 | fault-location | Verify the fault location. |
| | clear-rapid-fault | Clear rapid faults. |
| | restart-sign-on | Restart the Sign On process and refresh the participants list. |
| | clear-gateway-fault | Clear partial network fault condition in the gateway. The function is only available if the device is capable of being a gateway, and you enable the gateway for the specified ring. |

16.2 show

Display device options and settings.

16.2.1 show dlr global

Show the global configuration of the DLR feature.

- ▶ Mode: Command is in all modes available.
- ▶ Privilege Level: Guest
- ▶ Format: show dlr global

16.2.2 show dlr ring config

Show the configuration of the DLR ring.

- ▶ Mode: Command is in all modes available.
- ▶ Privilege Level: Guest
- ▶ Format: show dlr ring config [<P-1>]

| Parameter | Value | Meaning |
|-----------|--------|------------------|
| P-1 | 1..255 | The DLR ring ID. |

16.2.3 show dlr ring status

Show the status of the DLR ring.

- ▶ Mode: Command is in all modes available.
- ▶ Privilege Level: Guest
- ▶ Format: show dlr ring status [<P-1>]

| Parameter | Value | Meaning |
|-----------|--------|------------------|
| P-1 | 1..255 | The DLR ring ID. |

16.2.4 show dlr ring participants

Show the participants list of the DLR ring.

- ▶ **Mode:** Command is in all modes available.
- ▶ **Privilege Level:** Guest
- ▶ **Format:** show dlr ring participants [<P-1> [<P-2>]]

| Parameter | Value | Meaning |
|-----------|----------|------------------------------|
| P-1 | 1..255 | The DLR ring ID. |
| P-2 | 1..65535 | The DLR ring participant ID. |

16.2.5 show dlr gateway config

Show the configuration of the DLR gateway.

- ▶ **Mode:** Command is in all modes available.
- ▶ **Privilege Level:** Guest
- ▶ **Format:** show dlr gateway config [<P-1>] [<P-2>]

| Parameter | Value | Meaning |
|-----------|--------|---------------------|
| P-1 | 1..255 | The DLR ring ID. |
| P-2 | 1..255 | The DLR gateway ID. |

16.2.6 show dlr gateway status

Show the status of the DLR gateway.

- ▶ **Mode:** Command is in all modes available.
- ▶ **Privilege Level:** Guest
- ▶ **Format:** show dlr gateway status [<P-1>] [<P-2>]

| Parameter | Value | Meaning |
|-----------|--------|---------------------|
| P-1 | 1..255 | The DLR ring ID. |
| P-2 | 1..255 | The DLR gateway ID. |

17 DoS Mitigation

17.1 dos

Manage DoS Mitigation

17.1.1 dos tcp-null

Enables TCP Null scan protection - all TCP flags and TCP sequence number zero.

- ▶ Mode: Global Config Mode
- ▶ Privilege Level: Operator
- ▶ Format: dos tcp-null

■ no dos tcp-null

Disable the option

- ▶ Mode: Global Config Mode
- ▶ Privilege Level: Operator
- ▶ Format: no dos tcp-null

17.1.2 dos tcp-xmas

Enables TCP XMAS scan protection - TCP FIN, URG, PSH equal 1 and SEQ equals 0.

- ▶ Mode: Global Config Mode
- ▶ Privilege Level: Operator
- ▶ Format: dos tcp-xmas

■ no dos tcp-xmas

Disable the option

- ▶ Mode: Global Config Mode
- ▶ Privilege Level: Operator
- ▶ Format: no dos tcp-xmas

17.1.3 dos tcp-syn-fin

Enables TCP SYN/FIN scan protection - TCP with SYN and FIN flags set.

- ▶ Mode: Global Config Mode
- ▶ Privilege Level: Operator
- ▶ Format: dos tcp-syn-fin

■ no dos tcp-syn-fin

Disable the option

- ▶ Mode: Global Config Mode
- ▶ Privilege Level: Operator
- ▶ Format: no dos tcp-syn-fin

17.1.4 dos tcp-min-header

Enables TCP minimal header size check.

- ▶ Mode: Global Config Mode
- ▶ Privilege Level: Operator
- ▶ Format: dos tcp-min-header

■ no dos tcp-min-header

Disable the option

- ▶ Mode: Global Config Mode
- ▶ Privilege Level: Operator
- ▶ Format: no dos tcp-min-header

17.1.5 dos icmp-fragmented

Enables fragmented ICMP protection.

- ▶ Mode: Global Config Mode
- ▶ Privilege Level: Operator
- ▶ Format: dos icmp-fragmented

■ **no dos icmp-fragmented**

Disable the option

- ▶ Mode: Global Config Mode
- ▶ Privilege Level: Operator
- ▶ Format: no dos icmp-fragmented

17.1.6 dos icmp payload-check

Enables ICMP max payload size protection for IPv4 and IPv6.

- ▶ Mode: Global Config Mode
- ▶ Privilege Level: Operator
- ▶ Format: dos icmp payload-check

■ **no dos icmp payload-check**

Disable the option

- ▶ Mode: Global Config Mode
- ▶ Privilege Level: Operator
- ▶ Format: no dos icmp payload-check

17.1.7 dos icmp payload-size

Configures maximum ICMP payload size (default: 512).

- ▶ Mode: Global Config Mode
- ▶ Privilege Level: Operator
- ▶ Format: dos icmp payload-size <P-1>

| Parameter | Value | Meaning |
|-----------|---------|---------------------------------------|
| P-1 | 0..1472 | Max. ICMP payload size (default: 512) |

17.1.8 dos ip-land

Enables LAND attack protection - source IP equals destination IP.

- ▶ Mode: Global Config Mode
- ▶ Privilege Level: Operator
- ▶ Format: dos ip-land <P-1>

| Parameter | Value | Meaning |
|-----------|---------|---------------------|
| P-1 | enable | Enable the option. |
| | disable | Disable the option. |

17.1.9 dos tcp-offset

Enables TCP offset check - ingress TCP packets with fragment offset 1 are dropped.

- ▶ Mode: Global Config Mode
- ▶ Privilege Level: Operator
- ▶ Format: dos tcp-offset

■ no dos tcp-offset

Disable the option

- ▶ Mode: Global Config Mode
- ▶ Privilege Level: Operator
- ▶ Format: no dos tcp-offset

17.1.10 dos tcp-syn

Enables TCP source port smaller than 1024 protection.

- ▶ Mode: Global Config Mode
- ▶ Privilege Level: Operator
- ▶ Format: dos tcp-syn

■ no dos tcp-syn

Disable the option

- ▶ Mode: Global Config Mode
- ▶ Privilege Level: Operator
- ▶ Format: no dos tcp-syn

17.1.11 dos l4-port

Enables UDP or TCP source port equals destination port check.

- ▶ **Mode:** Global Config Mode
- ▶ **Privilege Level:** Operator
- ▶ **Format:** dos l4-port

■ **no dos l4-port**

Disable the option

- ▶ **Mode:** Global Config Mode
- ▶ **Privilege Level:** Operator
- ▶ **Format:** no dos l4-port

17.2 show

Display device options and settings.

17.2.1 show dos

Show DoS Mitigation parameters

- ▶ **Mode:** Command is in all modes available.
- ▶ **Privilege Level:** Guest
- ▶ **Format:** show dos

18 IEEE 802.1x (Dot1x)

18.1 dot1x

Configure 802.1X parameters.

18.1.1 dot1x dynamic-vlan

Creates VLANs dynamically when a RADIUS-assigned VLAN does not exist.

- ▶ Mode: Global Config Mode
- ▶ Privilege Level: Operator
- ▶ Format: dot1x dynamic-vlan

■ no dot1x dynamic-vlan

Disable the option

- ▶ Mode: Global Config Mode
- ▶ Privilege Level: Operator
- ▶ Format: no dot1x dynamic-vlan

18.1.2 dot1x system-auth-control

Enable or disable 802.1X authentication support on the switch.

- ▶ Mode: Global Config Mode
- ▶ Privilege Level: Operator
- ▶ Format: dot1x system-auth-control

■ no dot1x system-auth-control

Disable the option

- ▶ Mode: Global Config Mode
- ▶ Privilege Level: Operator
- ▶ Format: no dot1x system-auth-control

18.1.3 dot1x monitor

Enable or disable 802.1X monitor mode.

- ▶ Mode: Global Config Mode
- ▶ Privilege Level: Operator
- ▶ Format: dot1x monitor

■ no dot1x monitor

Disable the option

- ▶ Mode: Global Config Mode
- ▶ Privilege Level: Operator
- ▶ Format: no dot1x monitor

18.2 dot1x

Configure 802.1X interface parameters.

18.2.1 dot1x guest-vlan

Configure a VLAN as 802.1X guest VLAN.

- ▶ Mode: Interface Range Mode
- ▶ Privilege Level: Operator
- ▶ Format: dot1x guest-vlan <P-1>

| Parameter | Value | Meaning |
|-----------|---------|---|
| P-1 | 0..4042 | Enter the VLAN ID. Entering of ID 0 disables the feature. |

18.2.2 dot1x max-req

Configure the maximum number of requests to be sent.

- ▶ Mode: Interface Range Mode
- ▶ Privilege Level: Operator
- ▶ Format: dot1x max-req <P-1>

| Parameter | Value | Meaning |
|-----------|-------|--|
| P-1 | 1..10 | Maximum number of requests (default: 2). |

18.2.3 dot1x port-control

Set the authentication mode on the specified port.

- ▶ Mode: Interface Range Mode
- ▶ Privilege Level: Operator
- ▶ Format: dot1x port-control <P-1>

| Parameter | Value | Meaning |
|-----------|--------------------|---|
| P-1 | auto | Port is actually controlled by protocol. |
| | force-authorized | Port is authorized unconditionally (default). |
| | force-unauthorized | Port is unauthorized unconditionally. |
| | multi-client | If more than one client is attached to the port, then each client needs to authenticate separately. |

18.2.4 dot1x re-authentication

Enable or disable re-authentication for the given interface.

- ▶ Mode: Interface Range Mode
- ▶ Privilege Level: Operator
- ▶ Format: dot1x re-authentication

■ no dot1x re-authentication

Disable the option

- ▶ Mode: Interface Range Mode
- ▶ Privilege Level: Operator
- ▶ Format: no dot1x re-authentication

18.2.5 dot1x unauthenticated-vlan

Configure a VLAN as 802.1X unauthenticated VLAN.

- ▶ Mode: Interface Range Mode
- ▶ Privilege Level: Operator
- ▶ Format: dot1x unauthenticated-vlan <P-1>

| Parameter | Value | Meaning |
|-----------|---------|---|
| P-1 | 0..4042 | Enter the VLAN ID. Entering of ID 0 disables the feature. |

18.2.6 dot1x timeout guest-vlan-period

Configure the guest-vlan period value.

- ▶ Mode: Interface Range Mode
- ▶ Privilege Level: Operator
- ▶ Format: dot1x timeout guest-vlan-period <P-1>

| Paramete | Value | Meaning |
|----------|--------|--|
| P-1 | 1..300 | Guest-vlan timeout in seconds (default: 90). |

18.2.7 dot1x timeout reauth-period

Configure the re-authentication period.

- ▶ Mode: Interface Range Mode
- ▶ Privilege Level: Operator
- ▶ Format: dot1x timeout reauth-period <P-1>

| Paramete | Value | Meaning |
|----------|----------|---------------------|
| P-1 | 1..65535 | Timeout in seconds. |

18.2.8 dot1x timeout quiet-period

Configure the quiet period value.

- ▶ Mode: Interface Range Mode
- ▶ Privilege Level: Operator
- ▶ Format: dot1x timeout quiet-period <P-1>

| Paramete | Value | Meaning |
|----------|----------|--|
| P-1 | 0..65535 | Quiet period in seconds (default: 60). |

18.2.9 dot1x timeout tx-period

Configure the transmit timeout period.

- ▶ Mode: Interface Range Mode
- ▶ Privilege Level: Operator
- ▶ Format: dot1x timeout tx-period <P-1>

| Parameter | Value | Meaning |
|-----------|----------|---------------------|
| P-1 | 1..65535 | Timeout in seconds. |

18.2.10 dot1x timeout supp-timeout

Configure the supplicant timeout period.

- ▶ Mode: Interface Range Mode
- ▶ Privilege Level: Operator
- ▶ Format: dot1x timeout supp-timeout <P-1>

| Parameter | Value | Meaning |
|-----------|----------|---------------------|
| P-1 | 1..65535 | Timeout in seconds. |

18.2.11 dot1x timeout server-timeout

Configure the server timeout period.

- ▶ Mode: Interface Range Mode
- ▶ Privilege Level: Operator
- ▶ Format: dot1x timeout server-timeout <P-1>

| Parameter | Value | Meaning |
|-----------|----------|---------------------|
| P-1 | 1..65535 | Timeout in seconds. |

18.2.12 dot1x initialize

Begins the initialization sequence on the specified port (port-control mode must be 'auto').

- ▶ Mode: Interface Range Mode
- ▶ Privilege Level: Operator
- ▶ Format: dot1x initialize

■ **no dot1x initialize**

Disable the option

- ▶ Mode: Interface Range Mode
- ▶ Privilege Level: Operator
- ▶ Format: no dot1x initialize

18.2.13 dot1x re-authenticate

Begins the re-authentication sequence on the specified port (port-control mode must be 'auto').

- ▶ Mode: Interface Range Mode
- ▶ Privilege Level: Operator
- ▶ Format: dot1x re-authenticate

■ **no dot1x re-authenticate**

Disable the option

- ▶ Mode: Interface Range Mode
- ▶ Privilege Level: Operator
- ▶ Format: no dot1x re-authenticate

18.3 show

Display device options and settings.

18.3.1 show dot1x global

Display global 802.1X configuration.

- ▶ Mode: Command is in all modes available.
- ▶ Privilege Level: Guest
- ▶ Format: show dot1x global

18.3.2 show dot1x auth-history

Display 802.1X authentication events and information.

- ▶ Mode: Command is in all modes available.
- ▶ Privilege Level: Guest
- ▶ Format: show dot1x auth-history [<P-1> [<P-2>]]

| Parameter | Value | Meaning |
|-----------|-------------------|--|
| P-1 | slot no./port no. | |
| P-2 | 1..4294967294 | 802.1X history log entry index. This can be specified only if interface is provided. Parameter Usage: [<slot/port> [index]] |

18.3.3 show dot1x detail

Display the detailed 802.1X configuration for the specified port.

- ▶ Mode: Command is in all modes available.
- ▶ Privilege Level: Guest
- ▶ Format: show dot1x detail <P-1>

| Parameter | Value | Meaning |
|-----------|-------------------|---------|
| P-1 | slot no./port no. | |

18.3.4 show dot1x summary

Display summary information of the 802.1X configuration for a specified port or all ports.

- ▶ **Mode:** Command is in all modes available.
- ▶ **Privilege Level:** Guest
- ▶ **Format:** show dot1x summary [<P-1>]

| Paramete | Value | Meaning |
|----------|-------------------|---------|
| P-1 | slot no./port no. | |

18.3.5 show dot1x clients

Display 802.1X client information.

- ▶ **Mode:** Command is in all modes available.
- ▶ **Privilege Level:** Guest
- ▶ **Format:** show dot1x clients [<P-1>]

| Paramete | Value | Meaning |
|----------|-------------------|--------------|
| P-1 | aa:bb:cc:dd:ee:ff | MAC address. |

18.3.6 show dot1x statistics

Display the 802.1X statistics for the specified port.

- ▶ **Mode:** Command is in all modes available.
- ▶ **Privilege Level:** Guest
- ▶ **Format:** show dot1x statistics <P-1>

| Paramete | Value | Meaning |
|----------|-------------------|---------|
| P-1 | slot no./port no. | |

18.4 clear

Clear several items.

18.4.1 clear dot1x statistics port

Resets the 802.1X statistics for specified port.

- ▶ Mode: Privileged Exec Mode
- ▶ Privilege Level: Operator
- ▶ Format: `clear dot1x statistics port <P-1>`

| Parameter | Value | Meaning |
|-----------|-------------------|---------|
| P-1 | slot no./port no. | |

18.4.2 clear dot1x statistics all

Resets the 802.1X statistics for all ports.

- ▶ Mode: Privileged Exec Mode
- ▶ Privilege Level: Operator
- ▶ Format: `clear dot1x statistics all`

18.4.3 clear dot1x auth-history port

Clears the 802.1X authentication history for specified port.

- ▶ Mode: Privileged Exec Mode
- ▶ Privilege Level: Operator
- ▶ Format: `clear dot1x auth-history port <P-1>`

| Parameter | Value | Meaning |
|-----------|-------------------|---------|
| P-1 | slot no./port no. | |

18.4.4 clear dot1x auth-history all

Clears the 802.1X authentication history for all ports.

- ▶ Mode: Privileged Exec Mode
- ▶ Privilege Level: Operator
- ▶ Format: `clear dot1x auth-history all`

19 IEEE 802.3ad (Dot3ad)

19.1 link-aggregation

Configure 802.3ad link aggregation parameters to increase bandwidth and provide redundancy by combining connections.

19.1.1 link-aggregation add

Create a new Link Aggregation Group to increase bandwidth and provide link redundancy. If desired, enter a name up to 15 alphanumeric characters in length.

- ▶ Mode: Global Config Mode
- ▶ Privilege Level: Operator
- ▶ Format: link-aggregation add <P-1>

| Parameter | Value | Meaning |
|-----------|---------------|--|
| P-1 | lag/<lagport> | lag/<lagport> Enter a lag interface in lag/lagport format. |

19.1.2 link-aggregation modify

Modify the parameters for the specified Link Aggregation Group.

- ▶ Mode: Global Config Mode
- ▶ Privilege Level: Operator
- ▶ Format: link-aggregation modify <P-1> name <P-2> addport <P-3> deleteport <P-4> adminmode linktrap static hashmode <P-5> min-links <P-6>

name: Modify the name of the specified Link Aggregation Group.

addport: Add the specified port to the Link Aggregation Group.

deleteport: Delete the specified port from the Link Aggregation Group.

adminmode: Modify the administration mode of the specified Link Aggregation Group. To activate the group, enable the administration mode.

linktrap: Enable/Disable link trap notifications for the specified Link Aggregation Group

static: Enable or disable static capability for the specified Link Aggregation Group on a device. When enabled, LACP automatically helps prevent loops and allows non-link aggregation partners to support LACP.

hashmode: Set the hash mode to be used by the load balancing algorithm for specified Link Aggregation Group.

min-links: Set the minimum links for the specified Link Aggregation Group.

| Parameter | Value | Meaning |
|-----------|-------------------|--|
| P-1 | slot no./port no. | |
| P-2 | string | Enter a user-defined text, max. 15 characters. |
| P-3 | slot no./port no. | |

| Parameter | Value | Meaning |
|-----------|-------------------|--|
| P-4 | slot no./port no. | |
| P-5 | src-mac | Source MAC, VLAN, EtherType, and incoming port associated with the packet. |
| | dst-mac | Destination MAC, VLAN, EtherType, and incoming port associated with the packet. |
| | src-dst-mac | Source/Destination MAC, VLAN, EtherType, and incoming port associated with the packet. |
| | src-ip | Source IP and Source TCP/UDP fields of the packet. |
| | dst-ip | Destination IP and Destination TCP/UDP Port fields of the packet. |
| | src-dst-ip | Source/Destination IP and source/destination TCP/UDP Port fields of the packet. |
| P-6 | slot no./port no. | |

■ no link-aggregation modify

Disable the option

▶ **Mode:** Global Config Mode

▶ **Privilege Level:** Operator

▶ **Format:** no link-aggregation modify <P-1> name addport deleteport adminmode linktrap static hashmode min-links

19.1.3 link-aggregation delete

Delete the Link Aggregation Group to divide the group into individual connections.

▶ **Mode:** Global Config Mode

▶ **Privilege Level:** Operator

▶ **Format:** link-aggregation delete <P-1>

| Parameter | Value | Meaning |
|-----------|-------------------|---------|
| P-1 | slot no./port no. | |

19.2 lacp

Configure lacp parameters.

19.2.1 lacp admin-key

Configure the administrative value of the key on this LAG.

- ▶ Mode: Interface Range Mode
- ▶ Privilege Level: Operator
- ▶ Format: lacp admin-key <P-1>

| Parameter | Value | Meaning |
|-----------|----------|------------------------------------|
| P-1 | 0..65535 | Enter a number between 0 and 65535 |

19.2.2 lacp collector-max-delay

Configure the collector max delay on this LAG (default is 0).

- ▶ Mode: Interface Range Mode
- ▶ Privilege Level: Operator
- ▶ Format: lacp collector-max-delay <P-1>

| Parameter | Value | Meaning |
|-----------|----------|------------------------------------|
| P-1 | 0..65535 | Enter a number between 0 and 65535 |

19.2.3 lacp lacpmode

Activate/deactivate LACP on an interface.

- ▶ Mode: Interface Range Mode
- ▶ Privilege Level: Operator
- ▶ Format: lacp lacpmode

■ no lacp lacpmode

Disable the option

- ▶ Mode: Interface Range Mode
- ▶ Privilege Level: Operator
- ▶ Format: no lacp lacpmode

19.2.4 lacp actor admin key

Configure the value of the LACP actor admin key on this port(default 0).

- ▶ Mode: Interface Range Mode
- ▶ Privilege Level: Operator
- ▶ Format: lacp actor admin key <P-1>

| Parameter | Value | Meaning |
|-----------|----------|------------------------------------|
| P-1 | 0..65535 | Enter a number between 0 and 65535 |

19.2.5 lacp actor admin state lacp-activity

Enable/disable the LACP activity on the actor admin state.

- ▶ Mode: Interface Range Mode
- ▶ Privilege Level: Operator
- ▶ Format: lacp actor admin state lacp-activity

■ no lacp actor admin state lacp-activity

Disable the option

- ▶ Mode: Interface Range Mode
- ▶ Privilege Level: Operator
- ▶ Format: no lacp actor admin state lacp-activity

19.2.6 lacp actor admin state lacp-timeout

Enable/disable the LACP timeout on the actor admin state.

- ▶ Mode: Interface Range Mode
- ▶ Privilege Level: Operator
- ▶ Format: lacp actor admin state lacp-timeout

■ no lacp actor admin state lacp-timeout

Disable the option

- ▶ Mode: Interface Range Mode
- ▶ Privilege Level: Operator
- ▶ Format: no lacp actor admin state lacp-timeout

19.2.7 lacp actor admin state aggregation

Enable/disable the aggregation on the actor admin state.

- ▶ Mode: Interface Range Mode
- ▶ Privilege Level: Operator
- ▶ Format: lacp actor admin state aggregation

■ no lacp actor admin state aggregation

Disable the option

- ▶ Mode: Interface Range Mode
- ▶ Privilege Level: Operator
- ▶ Format: no lacp actor admin state aggregation

19.2.8 lacp actor admin port priority

Set LACP actor port priority value (default 128).

- ▶ Mode: Interface Range Mode
- ▶ Privilege Level: Operator
- ▶ Format: lacp actor admin port priority <P-1>

| Parameter | Value | Meaning |
|-----------|----------|------------------------------------|
| P-1 | 0..65535 | Enter a number between 0 and 65535 |

19.2.9 lacp partner admin key

Configure the administrative value of the LACP key for the protocol partner on this LAG (default 0).

- ▶ Mode: Interface Range Mode
- ▶ Privilege Level: Operator
- ▶ Format: lacp partner admin key <P-1>

| Parameter | Value | Meaning |
|-----------|----------|------------------------------------|
| P-1 | 0..65535 | Enter a number between 0 and 65535 |

19.2.10 lacp partner admin state lacp-activity

Enable/disable the LACP activity on the partner admin state.

- ▶ Mode: Interface Range Mode
- ▶ Privilege Level: Operator
- ▶ Format: lacp partner admin state lacp-activity

■ no lacp partner admin state lacp-activity

Disable the option

- ▶ Mode: Interface Range Mode
- ▶ Privilege Level: Operator
- ▶ Format: no lacp partner admin state lacp-activity

19.2.11 lacp partner admin state lacp-timeout

Enable/disable the LACP timeout on the partner admin state.

- ▶ Mode: Interface Range Mode
- ▶ Privilege Level: Operator
- ▶ Format: lacp partner admin state lacp-timeout

■ no lacp partner admin state lacp-timeout

Disable the option

- ▶ Mode: Interface Range Mode
- ▶ Privilege Level: Operator
- ▶ Format: no lacp partner admin state lacp-timeout

19.2.12 lacp partner admin state aggregation

Enable/disable the state aggregation on the partner admin state.

- ▶ Mode: Interface Range Mode
- ▶ Privilege Level: Operator
- ▶ Format: lacp partner admin state aggregation

■ no lacp partner admin state aggregation

Disable the option

- ▶ Mode: Interface Range Mode
- ▶ Privilege Level: Operator
- ▶ Format: no lacp partner admin state aggregation

19.2.13 lacp partner admin port priority

Set LACP partner port priority value (default 128).

- ▶ Mode: Interface Range Mode
- ▶ Privilege Level: Operator
- ▶ Format: lacp partner admin port priority <P-1>

| Parameter | Value | Meaning |
|-----------|----------|------------------------------------|
| P-1 | 0..65535 | Enter a number between 0 and 65535 |

19.2.14 lacp partner admin port id

Set LACP partner port value (default 0).

- ▶ Mode: Interface Range Mode
- ▶ Privilege Level: Operator
- ▶ Format: lacp partner admin port id <P-1>

| Parameter | Value | Meaning |
|-----------|----------|------------------------------------|
| P-1 | 0..65535 | Enter a number between 0 and 65535 |

19.2.15 lacp partner admin system-priority

Configure the partner system priority.

- ▶ Mode: Interface Range Mode
- ▶ Privilege Level: Operator
- ▶ Format: lacp partner admin system-priority <P-1>

| Parameter | Value | Meaning |
|-----------|----------|------------------------------------|
| P-1 | 0..65535 | Enter a number between 0 and 65535 |

19.2.16 lacp partner admin system-id

Configure the MAC address representing the administrative value of the LAG ports protocol partner system ID default (00:00:00:00:00:00).

- ▶ Mode: Interface Range Mode
- ▶ Privilege Level: Operator
- ▶ Format: lacp partner admin system-id <P-1>

| Parameter | Value | Meaning |
|-----------|-------------------|--------------|
| P-1 | aa:bb:cc:dd:ee:ff | MAC address. |

19.3 show

Display device options and settings.

19.3.1 show link-aggregation port

Show LAG configuration of a single port.

- ▶ **Mode:** Command is in all modes available.
- ▶ **Privilege Level:** Guest
- ▶ **Format:** show link-aggregation port [<P-1>]

| Parameter | Value | Meaning |
|-----------|-------------------|---------|
| P-1 | slot no./port no. | |

19.3.2 show link-aggregation statistics

Show ports LAG statistics.

- ▶ **Mode:** Command is in all modes available.
- ▶ **Privilege Level:** Guest
- ▶ **Format:** show link-aggregation statistics [<P-1>]

| Parameter | Value | Meaning |
|-----------|-------------------|---------|
| P-1 | slot no./port no. | |

19.3.3 show link-aggregation members

Show the member ports for specified LAG.

- ▶ **Mode:** Command is in all modes available.
- ▶ **Privilege Level:** Guest
- ▶ **Format:** show link-aggregation members <P-1>

| Parameter | Value | Meaning |
|-----------|-------------------|---------|
| P-1 | slot no./port no. | |

19.3.4 show lacp interface

Show LAG interfaces attributes.

- ▶ Mode: Command is in all modes available.
- ▶ Privilege Level: Guest
- ▶ Format: show lacp interface [<P-1>]

| Parameter | Value | Meaning |
|-----------|-------------------|---------|
| P-1 | slot no./port no. | |

19.3.5 show lacp mode

Show lacp mode.

- ▶ Mode: Command is in all modes available.
- ▶ Privilege Level: Guest
- ▶ Format: show lacp mode [<P-1>]

| Parameter | Value | Meaning |
|-----------|-------------------|---------|
| P-1 | slot no./port no. | |

19.3.6 show lacp actor

Show Link Aggregation Control protocol actor attributes.

- ▶ Mode: Command is in all modes available.
- ▶ Privilege Level: Guest
- ▶ Format: show lacp actor [<P-1>]

| Parameter | Value | Meaning |
|-----------|-------------------|---------|
| P-1 | slot no./port no. | |

19.3.7 show lacp partner operational

Show Operational partner attributes.

- ▶ Mode: Command is in all modes available.
- ▶ Privilege Level: Guest
- ▶ Format: show lacp partner operational [<P-1>]

| Parameter | Value | Meaning |
|-----------|-------------------|---------|
| P-1 | slot no./port no. | |

19.3.8 show lacp partner admin

Show administrative partner attributes.

- ▶ **Mode:** Command is in all modes available.
- ▶ **Privilege Level:** Guest
- ▶ **Format:** show lacp partner admin [<P-1>]

| Parameter | Value | Meaning |
|-----------|-------------------|---------|
| P-1 | slot no./port no. | |

20 Ethernet IP

20.1 ethernet-ip

Enable or disable the EtherNet/IP operation on this device. If disabled, the EtherNet/IP protocol is deactivated, but the EtherNet/IP MIBs can be accessed.

20.1.1 ethernet-ip operation

Enable or disable the EtherNet-IP(TM) operation on this device. If disabled, the EtherNet/IP protocol is deactivated, but the EtherNet/IP MIBs can be accessed.

- ▶ Mode: Global Config Mode
- ▶ Privilege Level: Operator
- ▶ Format: ethernet-ip operation

■ no ethernet-ip operation

Disable the option

- ▶ Mode: Global Config Mode
- ▶ Privilege Level: Operator
- ▶ Format: no ethernet-ip operation

20.1.2 ethernet-ip write-access

Enable or disable the write-access of the EtherNet/IP protocol. - Possible security risk, as EtherNet/IP communication is not authenticated - .

- ▶ Mode: Global Config Mode
- ▶ Privilege Level: Operator
- ▶ Format: ethernet-ip write-access

■ no ethernet-ip write-access

Disable the option

- ▶ Mode: Global Config Mode
- ▶ Privilege Level: Operator
- ▶ Format: no ethernet-ip write-access

20.2 show

Display device options and settings.

20.2.1 show ethernet-ip

Show the Ethernet-ip settings.

- ▶ **Mode:** Command is in all modes available.
- ▶ **Privilege Level:** Guest
- ▶ **Format:** show ethernet-ip

20.3 copy

Copy different kinds of items.

20.3.1 copy eds-ethernet-ip system remote

Copy the EDS file from the device to a file server

- ▶ Mode: Privileged Exec Mode
- ▶ Privilege Level: Operator
- ▶ Format: copy eds-ethernet-ip system remote <P-1>

| Parameter | Value | Meaning |
|-----------|--------|---|
| P-1 | string | Enter a user-defined text, max. 128 characters. |

20.3.2 copy eds-ethernet-ip system envm

Copy the EDS file from the device to external non-volatile memory.

- ▶ Mode: Privileged Exec Mode
- ▶ Privilege Level: Operator
- ▶ Format: copy eds-ethernet-ip system envm

21 Filtering Database (FDB)

21.1 mac-filter

21.1.1 mac-filter

Static MAC filter configuration.

- ▶ Mode: Global Config Mode
- ▶ Privilege Level: Operator
- ▶ Format: mac-filter <P-1> <P-2>

| Parameter | Value | Meaning |
|-----------|-------------------|--------------------|
| P-1 | aa:bb:cc:dd:ee:ff | MAC address. |
| P-2 | 1..4042 | Enter the VLAN ID. |

■ no mac-filter

Disable the option

- ▶ Mode: Global Config Mode
- ▶ Privilege Level: Operator
- ▶ Format: no mac-filter <P-1> <P-2>

21.2 bridge

Bridge configuration.

21.2.1 bridge aging-time

Aging time configuration.

- ▶ Mode: Global Config Mode
- ▶ Privilege Level: Operator
- ▶ Format: bridge aging-time <P-1>

| Parameter | Value | Meaning |
|-----------|------------|------------------------------------|
| P-1 | 10..500000 | Enter a number in the given range. |

21.3 show

Display device options and settings.

21.3.1 show mac-filter-table static

Displays the MAC address filter table.

- ▶ **Mode:** Command is in all modes available.
- ▶ **Privilege Level:** Guest
- ▶ **Format:** show mac-filter-table static

21.4 show

Display device options and settings.

21.4.1 show bridge aging-time

Address aging time.

- ▶ **Mode:** Command is in all modes available.
- ▶ **Privilege Level:** Guest
- ▶ **Format:** show bridge aging-time

21.5 show

Display device options and settings.

21.5.1 show mac-addr-table

Displays the MAC address table.

- ▶ **Mode:** Command is in all modes available.
- ▶ **Privilege Level:** Guest
- ▶ **Format:** show mac-addr-table [<P-1>]

| Parameter | Value | Meaning |
|-----------|-------------|----------------------|
| P-1 | a:b:c:d:e:f | Enter a MAC address. |
| | 1..4042 | Enter a VLAN ID. |

21.6 clear

Clear several items.

21.6.1 clear mac-addr-table

Clears the MAC address table.

- ▶ Mode: Privileged Exec Mode
- ▶ Privilege Level: Operator
- ▶ Format: clear mac-addr-table

22 HiDiscovery

22.1 network

Configure the inband and outband connectivity.

22.1.1 network hidiscovery operation

Enable/disable the HiDiscovery protocol on this device.

- ▶ Mode: Privileged Exec Mode
- ▶ Privilege Level: Operator
- ▶ Format: network hidiscovery operation <P-1>

| Parameter | Value | Meaning |
|-----------|---------|-----------------------------------|
| P-1 | enable | Enable the HiDiscovery protocol. |
| | disable | Disable the HiDiscovery protocol. |

■ no network hidiscovery operation

Disable the option

- ▶ Mode: Privileged Exec Mode
- ▶ Privilege Level: Operator
- ▶ Format: no network hidiscovery operation <P-1>

22.1.2 network hidiscovery mode

Set the access level for HiDiscovery.

- ▶ Mode: Privileged Exec Mode
- ▶ Privilege Level: Operator
- ▶ Format: network hidiscovery mode <P-1>

| Parameter | Value | Meaning |
|-----------|------------|---|
| P-1 | read-write | Allow detection and configuration. |
| | read-only | Allow only detection, no configuration. |

22.1.3 network hidiscovery blinking

Enable/disable the HiDiscovery blinking sequence on this device. This preference is not saved in configuration

- ▶ Mode: Privileged Exec Mode
- ▶ Privilege Level: Operator
- ▶ Format: network hidiscovery blinking

■ no network hidiscovery blinking

Disable the option

- ▶ Mode: Privileged Exec Mode
- ▶ Privilege Level: Operator
- ▶ Format: no network hidiscovery blinking

22.1.4 network hidiscovery relay

Enable/disable the HiDiscovery relay status.

- ▶ Mode: Privileged Exec Mode
- ▶ Privilege Level: Operator
- ▶ Format: network hidiscovery relay

■ no network hidiscovery relay

Disable the option

- ▶ Mode: Privileged Exec Mode
- ▶ Privilege Level: Operator
- ▶ Format: no network hidiscovery relay

22.2 show

Display device options and settings.

22.2.1 show network hidiscovery

Show the HiDiscovery settings.

- ▶ **Mode:** Command is in all modes available.
- ▶ **Privilege Level:** Guest
- ▶ **Format:** show network hidiscovery

23 High-availability Seamless Redundancy (HSR)

23.1 hsr

Configure High-availability Seamless Redundancy protocol (HSR) parameters.

23.1.1 hsr operation

Enable or disable the High-availability Seamless Redundancy protocol (HSR).

- ▶ Mode: Global Config Mode
- ▶ Privilege Level: Operator
- ▶ Format: hsr operation

■ no hsr operation

Disable the option

- ▶ Mode: Global Config Mode
- ▶ Privilege Level: Operator
- ▶ Format: no hsr operation

23.1.2 hsr instance

Configure HSR instances

- ▶ Mode: Global Config Mode
- ▶ Privilege Level: Operator
- ▶ Format: hsr instance <P-1> operation port-a port-b supervision evaluate send redbox-exclusively mode <P-2> switching-node-type <P-3> redbox-id <P-4>

operation: Enable or disable the HSR instance.

port-a: Enable or disable the first port of HSR line.

port-b: Enable or disable the second port of the HSR line.

supervision: Configure the HSR supervision tx and rx packet handling.

evaluate: Enable or disable evaluation of received supervision packets.

send: Enable or disable sending of supervision packets.

redbox-exclusively: Enable sending of supervision packets for this RedBox exclusively. Use the no form of the command to send supervision packets for each connected VDAN and this RedBox (if send is enabled).

mode: Modify HSR operating mode.

switching-node-type: Modify HSR switching end node type.

redbox-id: Modify RedBox identity.

| Parameter | Value | Meaning |
|-----------|---------------|---|
| P-1 | 1..1 | Enter HSR instance number (only 1 supported). |
| P-2 | modeh | HSR mode h - bridging of HSR traffic (default HSR mode). |
| | modeu | HSR mode u - like mode h, but unicast messages are not removed. |
| P-3 | hsrredboxsan | An HSR RedBox with regular Ethernet traffic on its interlink. |
| | hsrredboxprpa | An HSR RedBox with PRP traffic for LAN A on its interlink. |
| | hsrredboxprpb | An HSR RedBox with PRP traffic for LAN B on its interlink. |
| P-4 | id1a | Redbox pair 1 to LAN A. |
| | id1b | Redbox pair 1 to LAN B. |
| | id2a | Redbox pair 2 to LAN A. |
| | id2b | Redbox pair 2 to LAN B. |
| | id3a | Redbox pair 3 to LAN A. |
| | id3b | Redbox pair 3 to LAN B. |
| | id4a | Redbox pair 4 to LAN A. |
| | id4b | RedBox pair 4 to LAN B. |
| | id5a | Redbox pair 5 to LAN A. |
| | id5b | Redbox pair 5 to LAN B. |
| | id6a | Redbox pair 6 to LAN A. |
| | id6b | Redbox pair 6 to LAN B. |
| | id7a | Redbox pair 7 to LAN A. |
| | id7b | Redbox pair 7 to LAN B. |

■ no hsr instance

Disable the option

- ▶ **Mode:** Global Config Mode
- ▶ **Privilege Level:** Operator
- ▶ **Format:** no hsr instance <P-1> operation port-a port-b supervision evaluate send redbox-exclusively mode switching-node-type redbox-id

23.2 clear

Clear several items.

23.2.1 clear hsr proxy-node-table

Clear proxy-node-table.

- ▶ Mode: Privileged Exec Mode
- ▶ Privilege Level: Operator
- ▶ Format: clear hsr proxy-node-table [<P-1>]

| Paramete Value | Meaning |
|----------------|---|
| P-1 1..1 | Enter HSR instance number (only 1 supported). |

23.2.2 clear hsr node-table

Clear node-table (received supervision packets).

- ▶ Mode: Privileged Exec Mode
- ▶ Privilege Level: Operator
- ▶ Format: clear hsr node-table [<P-1>]

| Paramete Value | Meaning |
|----------------|---|
| P-1 1..1 | Enter HSR instance number (only 1 supported). |

23.2.3 clear hsr counters

Clear HSR counters.

- ▶ Mode: Privileged Exec Mode
- ▶ Privilege Level: Operator
- ▶ Format: clear hsr counters [<P-1>]

| Paramete Value | Meaning |
|----------------|---|
| P-1 1..1 | Enter HSR instance number (only 1 supported). |

23.3 show

Display device options and settings.

23.3.1 show hsr global

Show global preferences.

- ▶ Mode: Command is in all modes available.
- ▶ Privilege Level: Guest
- ▶ Format: show hsr global

23.3.2 show hsr instance

Show HSR instances.

- ▶ Mode: Command is in all modes available.
- ▶ Privilege Level: Guest
- ▶ Format: show hsr instance [<P-1>]

| Parameter | Value | Meaning |
|-----------|-------|---|
| P-1 | 1..1 | Enter HSR instance number (only 1 supported). |

23.3.3 show hsr node-table

Show node table (received supervision packets).

- ▶ Mode: Command is in all modes available.
- ▶ Privilege Level: Guest
- ▶ Format: show hsr node-table [<P-1>]

| Parameter | Value | Meaning |
|-----------|-------|---|
| P-1 | 1..1 | Enter HSR instance number (only 1 supported). |

23.3.4 show hsr proxy-node-table

Show proxy node table.

- ▶ **Mode:** Command is in all modes available.
- ▶ **Privilege Level:** Guest
- ▶ **Format:** show hsr proxy-node-table [<P-1>]

| Paramete | Value | Meaning |
|----------|-------|---|
| P-1 | 1..1 | Enter HSR instance number (only 1 supported). |

23.3.5 show hsr counters

Show HSR counters.

- ▶ **Mode:** Command is in all modes available.
- ▶ **Privilege Level:** Guest
- ▶ **Format:** show hsr counters [<P-1>]

| Paramete | Value | Meaning |
|----------|-------|---|
| P-1 | 1..1 | Enter HSR instance number (only 1 supported). |

24 Hypertext Transfer Protocol (HTTP)

24.1 http

Set HTTP parameters.

24.1.1 http port

Set the HTTP port number.

- ▶ Mode: Global Config Mode
- ▶ Privilege Level: Administrator
- ▶ Format: http port <P-1>

| Parameter | Value | Meaning |
|-----------|----------|---|
| P-1 | 1..65535 | Port number of the HTTP server (default: 80). |

24.1.2 http server

Enable or disable the HTTP server.

- ▶ Mode: Global Config Mode
- ▶ Privilege Level: Administrator
- ▶ Format: http server

■ no http server

Disable the option

- ▶ Mode: Global Config Mode
- ▶ Privilege Level: Administrator
- ▶ Format: no http server

24.2 show

Display device options and settings.

24.2.1 show http

Show HTTP server information.

- ▶ **Mode:** Command is in all modes available.
- ▶ **Privilege Level:** Guest
- ▶ **Format:** show http

25 HTTP Secure (HTTPS)

25.1 https

Set HTTPS parameters.

25.1.1 https server

Enable or disable the HTTPS server.

- ▶ Mode: Global Config Mode
- ▶ Privilege Level: Administrator
- ▶ Format: https server

■ no https server

Disable the option

- ▶ Mode: Global Config Mode
- ▶ Privilege Level: Administrator
- ▶ Format: no https server

25.1.2 https port

Set the HTTPS port number.

- ▶ Mode: Global Config Mode
- ▶ Privilege Level: Administrator
- ▶ Format: https port <P-1>

| Parameter | Value | Meaning |
|-----------|----------|---|
| P-1 | 1..65535 | Port number of the web server (default: 443). |

25.1.3 https certificate

Generate/Delete HTTPS X509/PEM certificate.

- ▶ Mode: Global Config Mode
- ▶ Privilege Level: Administrator
- ▶ Format: https certificate <P-1>

| Parameter | Value | Meaning |
|-----------|----------|--------------------|
| P-1 | generate | Generates the item |
| | delete | Deletes the item |

25.2 copy

Copy different kinds of items.

25.2.1 copy httpscert remote

Copy X509/PEM certificate from a server to the specified destination.

- ▶ Mode: Privileged Exec Mode
- ▶ Privilege Level: Administrator
- ▶ Format: copy httpscert remote <P-1> nvm

nvm: Copy HTTPS certificate (PEM) from a server to the device.

| Parameter | Value | Meaning |
|-----------|--------|---|
| P-1 | string | Enter a user-defined text, max. 128 characters. |

25.2.2 copy httpscert envm

Copy X509/PEM certificate from external non-volatile memory to the specified destination.

- ▶ Mode: Privileged Exec Mode
- ▶ Privilege Level: Administrator
- ▶ Format: copy httpscert envm <P-1> nvm

nvm: Copy X509/PEM certificate from external non-volatile memory to the device.

| Parameter | Value | Meaning |
|-----------|--------|---|
| P-1 | string | Enter a user-defined text, max. 128 characters. |

25.3 show

Display device options and settings.

25.3.1 show https

Show HTTPS server information.

- ▶ **Mode:** Command is in all modes available.
- ▶ **Privilege Level:** Guest
- ▶ **Format:** show https

26 Integrated Authentication Server (IAS)

26.1 ias-users

Manage IAS Users and User Accounts.

26.1.1 ias-users add

Add a new IAS user.

- ▶ Mode: Global Config Mode
- ▶ Privilege Level: Administrator
- ▶ Format: `ias-users add <P-1>`

| Paramete Value | Meaning |
|----------------|---|
| P-1 string | <user> User name (up to 32 characters). |

26.1.2 ias-users delete

Delete an existing IAS user.

- ▶ Mode: Global Config Mode
- ▶ Privilege Level: Administrator
- ▶ Format: `ias-users delete <P-1>`

| Paramete Value | Meaning |
|----------------|---|
| P-1 string | <user> User name (up to 32 characters). |

26.1.3 ias-users enable

Enable IAS user.

- ▶ Mode: Global Config Mode
- ▶ Privilege Level: Administrator
- ▶ Format: `ias-users enable <P-1>`

| Paramete Value | Meaning |
|----------------|---|
| P-1 string | <user> User name (up to 32 characters). |

26.1.4 ias-users disable

Disable IAS user.

- ▶ Mode: Global Config Mode
- ▶ Privilege Level: Administrator
- ▶ Format: ias-users disable <P-1>

| Parameter | Value | Meaning |
|-----------|--------|---|
| P-1 | string | <user> User name (up to 32 characters). |

26.1.5 ias-users password

Change IAS user password.

- ▶ Mode: Global Config Mode
- ▶ Privilege Level: Administrator
- ▶ Format: ias-users password <P-1> [<P-2>]

| Parameter | Value | Meaning |
|-----------|--------|--|
| P-1 | string | <user> User name (up to 32 characters). |
| P-2 | string | Enter a user-defined text, max. 64 characters. |

26.2 show

Display device options and settings.

26.2.1 show ias-users

Display IAS users and user accounts information.

- ▶ **Mode:** Command is in all modes available.
- ▶ **Privilege Level:** Administrator
- ▶ **Format:** show ias-users

27 IEC 61850 MMS Server

27.1 iec61850-mms

Configure the IEC61850 MMS Server settings.

27.1.1 iec61850-mms operation

Enable or disable the IEC61850 MMS Server. The MMS server facilitates real-time distribution of data and supervisory control functions for substations.

- ▶ Mode: Global Config Mode
- ▶ Privilege Level: Operator
- ▶ Format: iec61850-mms operation

■ no iec61850-mms operation

Disable the option

- ▶ Mode: Global Config Mode
- ▶ Privilege Level: Operator
- ▶ Format: no iec61850-mms operation

27.1.2 iec61850-mms write-access

Enable or disable the Write-Access on IEC61850 bridge objects via MMS. Write services allow the MMS client to access application content. - Possible security risk, as MMS communication is not authenticated -

- ▶ Mode: Global Config Mode
- ▶ Privilege Level: Operator
- ▶ Format: iec61850-mms write-access

■ no iec61850-mms write-access

Disable the option

- ▶ Mode: Global Config Mode
- ▶ Privilege Level: Operator
- ▶ Format: no iec61850-mms write-access

27.1.3 iec61850-mms port

Defines the port number of the IEC61850 MMS server (default: 102).

- ▶ Mode: Global Config Mode
- ▶ Privilege Level: Operator
- ▶ Format: iec61850-mms port <P-1>

| Parameter | Value | Meaning |
|-----------|----------|--|
| P-1 | 1..65535 | Port number of the IEC61850 MMS server (default: 102). |

27.1.4 iec61850-mms max-sessions

Defines the maximum number of concurrent IEC61850 MMS sessions (default: 5).

- ▶ Mode: Global Config Mode
- ▶ Privilege Level: Operator
- ▶ Format: iec61850-mms max-sessions <P-1>

| Parameter | Value | Meaning |
|-----------|-------|--|
| P-1 | 1..15 | Maximum number of concurrent IEC61850 MMS sessions (default: 5). |

27.1.5 iec61850-mms technical-key

Defines the IEC61850 MMS Technical Key (default: KEY).

- ▶ Mode: Global Config Mode
- ▶ Privilege Level: Operator
- ▶ Format: iec61850-mms technical-key <P-1>

| Parameter | Value | Meaning |
|-----------|--------|--|
| P-1 | string | Enter a IEC61850-7-2 Ed. VisibleString, max. 32 characters. The following characters are allowed: VisibleString (FROM ('A' 'a' 'B' 'b' 'C' 'c' 'D' 'd' 'E' 'e' 'F' 'f' 'G' 'g' 'H' 'h' 'I' 'i' 'J' 'j' 'K' 'k' 'L' 'l' 'M' 'm' 'N' 'n' 'O' 'o' 'P' 'p' 'Q' 'q' 'R' 'r' 'S' 's' 'T' 't' 'U' 'u' 'V' 'v' 'W' 'w' 'X' 'x' 'Y' 'y' 'Z' 'z' ' ' '0' '1' '2' '3' '4' '5' '6' '7' '8' '9') |

27.2 show

Display device options and settings.

27.2.1 show iec61850-mms

Show the IEC61850 MMS Server settings.

- ▶ **Mode:** Command is in all modes available.
- ▶ **Privilege Level:** Guest
- ▶ **Format:** show iec61850-mms

28 Internet Group Management Protocol (IGMP)

28.1 show

Display device options and settings.

28.1.1 show ip igmp global

Display IGMP global configuration.

- ▶ Mode: Command is in all modes available.
- ▶ Privilege Level: Operator
- ▶ Format: show ip igmp global

28.1.2 show ip igmp interface

Display IGMP interface information.

- ▶ Mode: Command is in all modes available.
- ▶ Privilege Level: Operator
- ▶ Format: show ip igmp interface [<P-1>]

| Parameter | Value | Meaning |
|-----------|-------------------|---------|
| P-1 | slot no./port no. | |

28.1.3 show ip igmp membership

Display interfaces subscribed to the multicast group.

- ▶ Mode: Command is in all modes available.
- ▶ Privilege Level: Operator
- ▶ Format: show ip igmp membership

28.1.4 show ip igmp groups

Display the subscribed multicast groups.

- ▶ **Mode:** Command is in all modes available.
- ▶ **Privilege Level:** Operator
- ▶ **Format:** show ip igmp groups

28.1.5 show ip igmp statistics

Display IGMP statistical information.

- ▶ **Mode:** Command is in all modes available.
- ▶ **Privilege Level:** Operator
- ▶ **Format:** show ip igmp statistics [<P-1>]

| Parameter | Value | Meaning |
|-----------|-------------------|---------|
| P-1 | slot no./port no. | |

29 IGMP Proxy

29.1 show

Display device options and settings.

29.1.1 show ip igmp-proxy global

Displays a summary of the host interface status parameters.

- ▶ Mode: Command is in all modes available.
- ▶ Privilege Level: Guest
- ▶ Format: show ip igmp-proxy global

29.1.2 show ip igmp-proxy groups

Displays informations about the subscribed multicast groups that IGMP Proxy reported.

- ▶ Mode: Command is in all modes available.
- ▶ Privilege Level: Guest
- ▶ Format: show ip igmp-proxy groups

29.1.3 show ip igmp-proxy source-list

Displays the source-list of each subscribed multicast group that IGMP Proxy reported.

- ▶ Mode: Command is in all modes available.
- ▶ Privilege Level: Guest
- ▶ Format: show ip igmp-proxy source-list

30 IGMP Snooping

30.1 igmp-snooping

Configure IGMP snooping.

30.1.1 igmp-snooping mode

Enable or disable IGMP snooping.

- ▶ Mode: Global Config Mode
- ▶ Privilege Level: Operator
- ▶ Format: igmp-snooping mode

■ no igmp-snooping mode

Disable the option

- ▶ Mode: Global Config Mode
- ▶ Privilege Level: Operator
- ▶ Format: no igmp-snooping mode

30.1.2 igmp-snooping querier mode

Enable or disable IGMP snooping querier on the system.

- ▶ Mode: Global Config Mode
- ▶ Privilege Level: Operator
- ▶ Format: igmp-snooping querier mode

■ no igmp-snooping querier mode

Disable the option

- ▶ Mode: Global Config Mode
- ▶ Privilege Level: Operator
- ▶ Format: no igmp-snooping querier mode

30.1.3 igmp-snooping querier query-interval

Sets the IGMP querier query interval time (1-1800) in seconds.

- ▶ Mode: Global Config Mode
- ▶ Privilege Level: Operator
- ▶ Format: igmp-snooping querier query-interval <P-1>

| Parameter | Value | Meaning |
|-----------|---------|------------------------------------|
| P-1 | 1..1800 | Enter a number in the given range. |

30.1.4 igmp-snooping querier timer-expiry

Sets the IGMP querier timer expiration period (60-300) in seconds.

- ▶ Mode: Global Config Mode
- ▶ Privilege Level: Operator
- ▶ Format: igmp-snooping querier timer-expiry <P-1>

| Parameter | Value | Meaning |
|-----------|---------|------------------------------------|
| P-1 | 60..300 | Enter a number in the given range. |

30.1.5 igmp-snooping querier version

Sets the IGMP version (1-3) of the query.

- ▶ Mode: Global Config Mode
- ▶ Privilege Level: Operator
- ▶ Format: igmp-snooping querier version <P-1>

| Parameter | Value | Meaning |
|-----------|-------|--|
| P-1 | 1..3 | IGMP snooping querier's protocol version(1 to 3,default: 2). |

30.1.6 igmp-snooping forward-unknown

Configure if and how unknown multicasts are forwarded. The setting can be discard, flood or query-ports. The default is flood.

- ▶ Mode: Global Config Mode
- ▶ Privilege Level: Operator
- ▶ Format: igmp-snooping forward-unknown <P-1>

| Parameter | Value | Meaning |
|-----------|-------------|---|
| P-1 | discard | Unknown multicast frames will be discarded. |
| | flood | Unknown multicast frames will be flooded. |
| | query-ports | Unknown multicast frames will be forwarded only to query ports. |

30.2 igmp-snooping

Configure IGMP snooping.

30.2.1 igmp-snooping vlan-id

Configure the VLAN parameters.

- ▶ **Mode:** VLAN Database Mode
- ▶ **Privilege Level:** Operator
- ▶ **Format:** `igmp-snooping vlan-id <P-1> mode fast-leave groupmembership-interval <P-2> maxresponse <P-3> mcrtreptime <P-4> querier mode address <P-5> forward-known <P-6> forward-all <P-7> static-query-port <P-8> automatic-mode <P-9>`

`mode:` Enable or disable IGMP snooping per VLAN.

`fast-leave:` Enable or disable IGMP snooping fast-leave per VLAN.

`groupmembership-interval:` Set IGMP group membership interval time (2-3600) in seconds per VLAN.

`maxresponse:` Set the igmp maximum response time (1-25) in seconds per VLAN.

`mcrtreptime:` Sets the multicast router present expiration time (0-3600) in seconds per VLAN.

`querier:` Set IGMP snooping querier on the system.

`mode:` Enable or disable IGMP snooping querier per VLAN.

`address:` Set IGMP snooping querier address on the system using a VLAN.

`forward-known:` Sets the mode how known multicast packets will be treated. The default value is `registered-ports-only(2)`.

`forward-all:` Enable or disable IGMP snooping forward-all.

`static-query-port:` Enable or disable IGMP snooping static-query-port.

`automatic-mode:` Enable or disable IGMP snooping automatic-mode.

| Parameter | Value | Meaning |
|-----------|----------------------------|---|
| P-1 | 1..4042 | Enter the VLAN ID. |
| P-2 | 2..3600 | Enter a number in the given range. |
| P-3 | 1..25 | Enter a number in the given range. |
| P-4 | 0..3600 | Enter a number in the given range. |
| P-5 | a.b.c.d | IP address. |
| P-6 | query-and-registered-ports | Addition of query ports to multicast filter portmasks. |
| | registered-ports-only | No addition of query ports to multicast filter portmasks. |
| P-7 | slot no./port no. | |
| P-8 | slot no./port no. | |
| P-9 | slot no./port no. | |

■ **no igmp-snooping vlan-id**

Disable the option

▶ **Mode:** VLAN Database Mode

▶ **Privilege Level:** Operator

▶ **Format:** no igmp-snooping vlan-id <P-1> mode fast-leave groupmembership-interval maxresponse mcrtrexpiretime querier mode address forward-known forward-all <P-7> static-query-port <P-8> automatic-mode <P-9>

30.3 igmp-snooping

Configure IGMP snooping.

30.3.1 igmp-snooping mode

Enable or disable IGMP snooping per interface.

- ▶ Mode: Interface Range Mode
- ▶ Privilege Level: Operator
- ▶ Format: igmp-snooping mode

■ no igmp-snooping mode

Disable the option

- ▶ Mode: Interface Range Mode
- ▶ Privilege Level: Operator
- ▶ Format: no igmp-snooping mode

30.3.2 igmp-snooping fast-leave

Enable or disable IGMP snooping fast-leave per interface.

- ▶ Mode: Interface Range Mode
- ▶ Privilege Level: Operator
- ▶ Format: igmp-snooping fast-leave

■ no igmp-snooping fast-leave

Disable the option

- ▶ Mode: Interface Range Mode
- ▶ Privilege Level: Operator
- ▶ Format: no igmp-snooping fast-leave

30.3.3 igmp-snooping groupmembership-interval

Set IGMP group membership interval time (2-3600) in seconds per interface.

- ▶ Mode: Interface Range Mode
- ▶ Privilege Level: Operator
- ▶ Format: igmp-snooping groupmembership-interval <P-1>

| Parameter | Value | Meaning |
|-----------|---------|------------------------------------|
| P-1 | 2..3600 | Enter a number in the given range. |

30.3.4 igmp-snooping maxresponse

Set the igmp maximum response time (1-25) in seconds per interface.

- ▶ Mode: Interface Range Mode
- ▶ Privilege Level: Operator
- ▶ Format: igmp-snooping maxresponse <P-1>

| Parameter | Value | Meaning |
|-----------|-------|------------------------------------|
| P-1 | 1..25 | Enter a number in the given range. |

30.3.5 igmp-snooping mcrtrexpiretime

Sets the multicast router present expiration time (0-3600) in seconds per interface.

- ▶ Mode: Interface Range Mode
- ▶ Privilege Level: Operator
- ▶ Format: igmp-snooping mcrtrexpiretime <P-1>

| Parameter | Value | Meaning |
|-----------|---------|------------------------------------|
| P-1 | 0..3600 | Enter a number in the given range. |

30.3.6 igmp-snooping static-query-port

Configures the interface as a static query interface in all VLANs.

- ▶ Mode: Interface Range Mode
- ▶ Privilege Level: Operator
- ▶ Format: igmp-snooping static-query-port

■ **no igmp-snooping static-query-port**

Disable the option

- ▶ **Mode:** Interface Range Mode
- ▶ **Privilege Level:** Operator
- ▶ **Format:** no igmp-snooping static-query-port

30.4 show

Display device options and settings.

30.4.1 show igmp-snooping global

Show IGMP snooping global information.

- ▶ Mode: Command is in all modes available.
- ▶ Privilege Level: Guest
- ▶ Format: show igmp-snooping global

30.4.2 show igmp-snooping interface

Show IGMP snooping interface information.

- ▶ Mode: Command is in all modes available.
- ▶ Privilege Level: Guest
- ▶ Format: show igmp-snooping interface [<P-1>]

| Parameter | Value | Meaning |
|-----------|-------------------|---------|
| P-1 | slot no./port no. | |

30.4.3 show igmp-snooping vlan

Show IGMP snooping VLAN information.

- ▶ Mode: Command is in all modes available.
- ▶ Privilege Level: Guest
- ▶ Format: show igmp-snooping vlan [<P-1>]

| Parameter | Value | Meaning |
|-----------|---------|--------------------|
| P-1 | 1..4042 | Enter the VLAN ID. |

30.4.4 show igmp-snooping querier global

Show IGMP snooping querier information per VLAN.

- ▶ Mode: Command is in all modes available.
- ▶ Privilege Level: Guest
- ▶ Format: show igmp-snooping querier global

30.4.5 show igmp-snooping querier vlan

Show IGMP snooping querier VLAN information.

- ▶ Mode: Command is in all modes available.
- ▶ Privilege Level: Guest
- ▶ Format: show igmp-snooping querier vlan [<P-1>]

| Parameter | Value | Meaning |
|-----------|---------|--------------------|
| P-1 | 1..4042 | Enter the VLAN ID. |

30.4.6 show igmp-snooping enhancements vlan

Show IGMP snooping VLAN information.

- ▶ Mode: Command is in all modes available.
- ▶ Privilege Level: Guest
- ▶ Format: show igmp-snooping enhancements vlan [<P-1>]

| Parameter | Value | Meaning |
|-----------|---------|--------------------|
| P-1 | 1..4042 | Enter the VLAN ID. |

30.4.7 show igmp-snooping enhancements unknown-filtering

Show unknown multicast filtering information.

- ▶ Mode: Command is in all modes available.
- ▶ Privilege Level: Guest
- ▶ Format: show igmp-snooping enhancements unknown-filtering

30.4.8 show igmp-snooping statistics global

Show number of control packets processed by CPU.

- ▶ Mode: Command is in all modes available.
- ▶ Privilege Level: Guest
- ▶ Format: show igmp-snooping statistics global

30.4.9 show igmp-snooping statistics interface

Show number of control packets processed by CPU per interface.

- ▶ Mode: Command is in all modes available.
- ▶ Privilege Level: Guest
- ▶ Format: show igmp-snooping statistics interface [<P-1>]

| Parameter | Value | Meaning |
|-----------|-------------------|---------|
| P-1 | slot no./port no. | |

30.5 show

Display device options and settings.

30.5.1 show mac-filter-table igmp-snooping

Display IGMP snooping entries in the MFDB table.

- ▶ **Mode:** Command is in all modes available.
- ▶ **Privilege Level:** Guest
- ▶ **Format:** show mac-filter-table igmp-snooping

30.6 clear

Clear several items.

30.6.1 clear igmp-snooping

Clear all IGMP snooping entries.

- ▶ Mode: Privileged Exec Mode
- ▶ Privilege Level: Operator
- ▶ Format: `clear igmp-snooping`

31 Interface

31.1 shutdown

31.1.1 shutdown

Enable or disable the interface.

- ▶ Mode: Interface Range Mode
- ▶ Privilege Level: Operator
- ▶ Format: shutdown

■ no shutdown

Disable the option

- ▶ Mode: Interface Range Mode
- ▶ Privilege Level: Operator
- ▶ Format: no shutdown

31.2 auto-negotiate

31.2.1 auto-negotiate

Enable or disable automatic negotiation on the interface. The cable crossing settings have no effect if auto-negotiation is enabled. In this case cable crossing is always set to auto. Cable crossing is set to the value chosen by the user if auto-negotiation is disabled.

- ▶ Mode: Interface Range Mode
- ▶ Privilege Level: Operator
- ▶ Format: auto-negotiate

■ no auto-negotiate

Disable the option

- ▶ Mode: Interface Range Mode
- ▶ Privilege Level: Operator
- ▶ Format: no auto-negotiate

31.3 auto-power-down

31.3.1 auto-power-down

Set the auto-power-down mode on the interface.

- ▶ Mode: Interface Range Mode
- ▶ Privilege Level: Operator
- ▶ Format: auto-power-down <P-1>

| Parameter | Value | Meaning |
|-----------|-----------------|--|
| P-1 | auto-power-save | The port goes in a low power mode. |
| | no-power-save | The port does not use the automatic power save mode. |

31.4 cable-crossing

31.4.1 cable-crossing

Cable crossing settings on the interface. The cable crossing settings have no effect if auto-negotiation is enabled. In this case cable crossing is always set to auto. Cable crossing is set to the value chosen by the user if auto-negotiation is disabled.

- ▶ Mode: Interface Range Mode
- ▶ Privilege Level: Operator
- ▶ Format: `cable-crossing <P-1>`

| Parameter | Value | Meaning |
|-----------|-----------|---|
| P-1 | mdi | The port does not use the crossover mode. |
| | mdix | The port uses the crossover mode. |
| | auto-mdix | The port uses the auto crossover mode. |

31.5 linktraps

31.5.1 linktraps

Enable/disable link up/down traps on the interface.

- ▶ Mode: Interface Range Mode
- ▶ Privilege Level: Operator
- ▶ Format: linktraps

■ no linktraps

Disable the option

- ▶ Mode: Interface Range Mode
- ▶ Privilege Level: Operator
- ▶ Format: no linktraps

31.6 link-loss-alert

Configure Link Loss Alert on the interface.

31.6.1 link-loss-alert operation

Enable or disable Link Loss Alert on the interface.

- ▶ **Mode:** Interface Range Mode
- ▶ **Privilege Level:** Operator
- ▶ **Format:** link-loss-alert operation

■ **no link-loss-alert operation**

Disable the option

- ▶ **Mode:** Interface Range Mode
- ▶ **Privilege Level:** Operator
- ▶ **Format:** no link-loss-alert operation

31.7 speed

31.7.1 speed

Sets the speed and duplex setting for the interface.

- ▶ Mode: Interface Range Mode
- ▶ Privilege Level: Operator
- ▶ Format: speed <P-1> [<P-2>]

| Parameter | Value | Meaning |
|-----------|-------|--------------|
| P-1 | 10 | 10 MBit/s. |
| | 100 | 100 MBit/s. |
| | 1000 | 1000 MBit/s. |
| P-2 | full | full duplex. |
| | half | half duplex. |

31.8 name

31.8.1 name

Set or remove a descriptive name for the interface.

- ▶ Mode: Interface Range Mode
- ▶ Privilege Level: Operator
- ▶ Format: name <P-1>

| Parameter | Value | Meaning |
|-----------|--------|--|
| P-1 | string | Enter a user-defined text, max. 64 characters. |

31.9 power-state

31.9.1 power-state

Enable or disable the power state on the interface. The interface power state settings have no effect if the interface admin state is enabled.

- ▶ Mode: Interface Range Mode
- ▶ Privilege Level: Operator
- ▶ Format: power-state

■ no power-state

Disable the option

- ▶ Mode: Interface Range Mode
- ▶ Privilege Level: Operator
- ▶ Format: no power-state

31.10 mac-filter

31.10.1 mac-filter

static mac filter configuration

- ▶ Mode: Interface Range Mode
- ▶ Privilege Level: Operator
- ▶ Format: mac-filter <P-1> <P-2>

| Parameter | Value | Meaning |
|-----------|-------------------|--------------------|
| P-1 | aa:bb:cc:dd:ee:ff | MAC address. |
| P-2 | 1..4042 | Enter the VLAN ID. |

■ no mac-filter

Disable the option

- ▶ Mode: Interface Range Mode
- ▶ Privilege Level: Operator
- ▶ Format: no mac-filter <P-1> <P-2>

31.11 led-signaling

Enable or disable Port LED signaling.

31.11.1 led-signaling operation

Enable or disable Port LED signaling.

- ▶ Mode: Interface Range Mode
- ▶ Privilege Level: Operator
- ▶ Format: led-signaling operation

■ no led-signaling operation

Disable the option

- ▶ Mode: Interface Range Mode
- ▶ Privilege Level: Operator
- ▶ Format: no led-signaling operation

31.12 show

Display device options and settings.

31.12.1 show port

Show interface parameters.

- ▶ **Mode:** Command is in all modes available.
- ▶ **Privilege Level:** Guest
- ▶ **Format:** show port [<P-1>]

| Parameter | Value | Meaning |
|-----------|-------------------|---------|
| P-1 | slot no./port no. | |

31.13 show

Display device options and settings.

31.13.1 show link-loss-alert

Show link-loss-alert parameters.

- ▶ **Mode:** Command is in all modes available.
- ▶ **Privilege Level:** Guest
- ▶ **Format:** show link-loss-alert [<P-1>]

| Parameter | Value | Meaning |
|-----------|-------------------|---------|
| P-1 | slot no./port no. | |

31.14 show

Display device options and settings.

31.14.1 show led-signaling operation

Show Port LED signaling operation.

- ▶ **Mode:** Command is in all modes available.
- ▶ **Privilege Level:** Guest
- ▶ **Format:** show led-signaling operation

32 Interface Statistics

32.1 utilization

Configure the interface utilization parameters.

32.1.1 utilization control-interval

Add interval time to monitor the bandwidth utilization of the interface.

- ▶ Mode: Interface Range Mode
- ▶ Privilege Level: Operator
- ▶ Format: utilization control-interval <P-1>

| Parameter | Value | Meaning |
|-----------|---------|---|
| P-1 | 1..3600 | Add interval time to monitor the bandwidth utilization. |

32.1.2 utilization alarm-threshold lower

Lower threshold value

- ▶ Mode: Interface Range Mode
- ▶ Privilege Level: Operator
- ▶ Format: utilization alarm-threshold lower <P-1>

| Parameter | Value | Meaning |
|-----------|----------|--|
| P-1 | 0..10000 | Add alarm threshold lower value for monitoring bandwidth utilization in hundredths of a percent. |

32.1.3 utilization alarm-threshold upper

Upper threshold value

- ▶ Mode: Interface Range Mode
- ▶ Privilege Level: Operator
- ▶ Format: utilization alarm-threshold upper <P-1>

| Parameter | Value | Meaning |
|-----------|----------|--|
| P-1 | 0..10000 | Add alarm threshold upper value for monitoring bandwidth utilization in hundredths of a percent. |

32.2 clear

Clear several items.

32.2.1 clear port-statistics

Clear all statistics counter.

- ▶ Mode: Privileged Exec Mode
- ▶ Privilege Level: Operator
- ▶ Format: clear port-statistics

32.3 show

Display device options and settings.

32.3.1 show interface counters

Show Table with interface counters.

- ▶ Mode: Command is in all modes available.
- ▶ Privilege Level: Guest
- ▶ Format: show interface counters

32.3.2 show interface layout

Show interface layout of the device.

- ▶ Mode: Command is in all modes available.
- ▶ Privilege Level: Guest
- ▶ Format: show interface layout

32.3.3 show interface utilization

Show interface utilization.

- ▶ Mode: Command is in all modes available.
- ▶ Privilege Level: Guest
- ▶ Format: show interface utilization [<P-1>]

| Parameter | Value | Meaning |
|-----------|-------------------|---------|
| P-1 | slot no./port no. | |

32.3.4 show interface statistics

Show summary interface statistics.

- ▶ Mode: Command is in all modes available.
- ▶ Privilege Level: Guest
- ▶ Format: show interface statistics [<P-1>]

| Paramete | Value | Meaning |
|----------|-------------------|---------|
| r | | |
| P-1 | slot no./port no. | |

32.3.5 show interface ether-stats

Show detailed interface statistics.

- ▶ Mode: Command is in all modes available.
- ▶ Privilege Level: Guest
- ▶ Format: show interface ether-stats [<P-1>]

| Paramete | Value | Meaning |
|----------|-------------------|---------|
| r | | |
| P-1 | slot no./port no. | |

33 Intern

33.1 help

Display help for various special keys.

- ▶ **Mode:** Command is in all modes available.
- ▶ **Privilege Level:** Guest
- ▶ **Format:** help

33.2 logout

Exit this session.

- ▶ **Mode:** Command is in all modes available.
- ▶ **Privilege Level:** any
- ▶ **Format:** logout

33.3 history

Show a list of previously run commands.

- ▶ **Mode:** Command is in all modes available.
- ▶ **Privilege Level:** Guest
- ▶ **Format:** history

33.4 vlan-mode

33.4.1 vlan-mode

Enter VLAN Configuration Mode.

- ▶ Mode: Global Config Mode
- ▶ Privilege Level: Operator
- ▶ Format: vlan-mode <P-1>

| Parameter | Value | Meaning |
|-----------|---------------|---|
| P-1 | all | Select all VLAN configured. |
| | vlan | Enter single VLAN. |
| | vlan range | Enter VLAN range separated by hyphen e.g 1-4. |
| | vlan list | Enter VLAN list separated by comma e.g 2,4,6,... . |
| | complex range | Enter VLAN range and several VLAN separated by comma for a list and hyphen for ranges e.g 2-4,6-9,11. |

33.5 exit

Exit from vlan mode.

- ▶ Mode: VLAN Mode
- ▶ Privilege Level: Operator
- ▶ Format: `exit`

33.6 end

Exit to exec mode.

- ▶ Mode: Interface Range Mode
- ▶ Privilege Level: Operator
- ▶ Format: end

33.7 serviceshell

Enter system mode.

33.7.1 serviceshell deactivate

Disable the service shell access permanently (Cannot be undone).

- ▶ **Mode:** Privileged Exec Mode
- ▶ **Privilege Level:** Administrator
- ▶ **Format:** serviceshell deactivate

33.8 serviceshell-f

Enter system mode.

33.8.1 serviceshell-f deactivate

Disable the service shell access permanently (Cannot be undone).

- ▶ Mode: Factory Mode
- ▶ Privilege Level: Administrator
- ▶ Format: `serviceshell-f deactivate`

33.9 traceroute

Trace route to a specified host.

33.9.1 traceroute maxttl

Set max TTL value.

► **Mode:** Privileged Exec Mode

► **Privilege Level:** Operator

► **Format:** traceroute <P-1> maxttl <P-2> [initttl <P-3>] [interval <P-4>] [count <P-5>] [maxFail <P-6>] [size <P-7>] [port <P-8>]

[initttl]: Initial TTL value.

[interval]: Timeout until probe failure.

[count]: Number of probes for each TTL.

[maxFail]: Maximum number of consecutive probes that can fail.

[size]: Size of payload in bytes.

[port]: UDP destination port.

| Parameter | Value | Meaning |
|-----------|----------|---------------------------------------|
| P-1 | string | Hostname or IP address. |
| P-2 | 1..255 | Enter a number in the given range. |
| P-3 | 0..255 | Enter a number in the given range. |
| P-4 | 1..60 | Enter a number in the given range. |
| P-5 | 1..10 | Enter a number in the given range. |
| P-6 | 0..255 | Enter a number in the given range. |
| P-7 | 0..65507 | Enter a number in the given range. |
| P-8 | 1..65535 | Enter port number between 1 and 65535 |

33.10 traceroute

Trace route to a specified host.

33.10.1 traceroute source

Source address for traceroute command.

- ▶ Mode: Privileged Exec Mode
- ▶ Privilege Level: Operator
- ▶ Format: traceroute <P-1> source <P-2>

| Parameter | Value | Meaning |
|-----------|---------|-------------------------|
| P-1 | string | Hostname or IP address. |
| P-2 | A.B.C.D | IP address. |

33.11 reboot

Reset the device (cold start).

33.11.1 reboot after

Schedule reboot after specified time.

- ▶ Mode: All Privileged Modes
- ▶ Privilege Level: any
- ▶ Format: reboot after <P-1>

| Parameter | Value | Meaning |
|-----------|------------|--|
| P-1 | 0..2147483 | Enter Seconds Between 0 to 2147483. Setting 0 will clear scheduled Reboot if configured. |

33.12 ping

33.12.1 ping

Send ICMP echo packets to a specified IP address.

- ▶ **Mode:** Command is in all modes available.
- ▶ **Privilege Level:** Guest
- ▶ **Format:** ping <P-1>

| Parameter | Value | Meaning |
|-----------|--------|-------------------------|
| P-1 | string | Hostname or IP address. |

33.13 ping

Send ICMP echo packets to a specified host or IP address.

33.13.1 ping source

Source address for ping command.

- ▶ **Mode:** Command is in all modes available.
- ▶ **Privilege Level:** Guest
- ▶ **Format:** ping <P-1> source <P-2>

| Parameter | Value | Meaning |
|-----------|---------|-------------------------|
| P-1 | string | Hostname or IP address. |
| P-2 | A.B.C.D | IP address. |

33.14 show

Display device options and settings.

33.14.1 show reboot

Display Configured reboot in seconds

- ▶ **Mode:** Command is in all modes available.
- ▶ **Privilege Level:** Guest
- ▶ **Format:** show reboot

33.14.2 show serviceshell

Display the service shell access.

- ▶ **Mode:** Command is in all modes available.
- ▶ **Privilege Level:** Guest
- ▶ **Format:** show serviceshell

34 Open Shortest Path First (OSPF)

34.1 show

Display device options and settings.

34.1.1 show ip ospf global

Display OSPF global configurations.

- ▶ **Mode:** Command is in all modes available.
- ▶ **Privilege Level:** Guest
- ▶ **Format:** show ip ospf global

34.1.2 show ip ospf area

Display OSPF area related information.

- ▶ **Mode:** Command is in all modes available.
- ▶ **Privilege Level:** Guest
- ▶ **Format:** show ip ospf area [<P-1>]

| Parameter | Value | Meaning |
|-----------|---------|-------------|
| P-1 | A.B.C.D | IP address. |

34.1.3 show ip ospf stub

Display OSPF stub area related information.

- ▶ **Mode:** Command is in all modes available.
- ▶ **Privilege Level:** Guest
- ▶ **Format:** show ip ospf stub

34.1.4 show ip ospf database internal

Display the internal LSA database information.

- ▶ Mode: Command is in all modes available.
- ▶ Privilege Level: Guest
- ▶ Format: show ip ospf database internal

34.1.5 show ip ospf database external

Display the external LSA database information.

- ▶ Mode: Command is in all modes available.
- ▶ Privilege Level: Guest
- ▶ Format: show ip ospf database external

34.1.6 show ip ospf range

Display OSPF area range information.

- ▶ Mode: Command is in all modes available.
- ▶ Privilege Level: Guest
- ▶ Format: show ip ospf range

34.1.7 show ip ospf interface

Display OSPF interface related information.

- ▶ Mode: Command is in all modes available.
- ▶ Privilege Level: Guest
- ▶ Format: show ip ospf interface [<P-1>]

| Parameter | Value | Meaning |
|-----------|-------------------|---------|
| P-1 | slot no./port no. | |

34.1.8 show ip ospf virtual-link

Display OSPF virtual-link related information.

- ▶ **Mode:** Command is in all modes available.
- ▶ **Privilege Level:** Guest
- ▶ **Format:** show ip ospf virtual-link <P-1> <P-2>

| Parameter | Value | Meaning |
|-----------|---------|-------------|
| P-1 | A.B.C.D | IP address. |
| P-2 | A.B.C.D | IP address. |

34.1.9 show ip ospf virtual-neighbor

Display OSPF Virtual-link neighbor information

- ▶ **Mode:** Command is in all modes available.
- ▶ **Privilege Level:** Guest
- ▶ **Format:** show ip ospf virtual-neighbor

34.1.10 show ip ospf neighbor

Display OSPF neighbor related information.

- ▶ **Mode:** Command is in all modes available.
- ▶ **Privilege Level:** Guest
- ▶ **Format:** show ip ospf neighbor [<P-1>]

| Parameter | Value | Meaning |
|-----------|-------------------|---------|
| P-1 | slot no./port no. | |

34.1.11 show ip ospf statistics

Display OSPF statistics.

- ▶ **Mode:** Command is in all modes available.
- ▶ **Privilege Level:** Guest
- ▶ **Format:** show ip ospf statistics

34.1.12 show ip ospf re-distribute

Display OSPF re-distribute related information

- ▶ Mode: Command is in all modes available.
- ▶ Privilege Level: Guest
- ▶ Format: show ip ospf re-distribute <P-1>

| Parameter | Value | Meaning |
|-----------|-----------|--|
| P-1 | connected | Select the source protocol as connected. |
| | static | Select the source protocol as static. |
| | rip | Select the source protocol as RIP. |

34.1.13 show ip ospf nssa

Display OSPF NSSA related information.

- ▶ Mode: Command is in all modes available.
- ▶ Privilege Level: Guest
- ▶ Format: show ip ospf nssa <P-1>

| Parameter | Value | Meaning |
|-----------|---------|-------------|
| P-1 | A.B.C.D | IP address. |

34.1.14 show ip ospf route

Display OSPF routes.

- ▶ Mode: Command is in all modes available.
- ▶ Privilege Level: Guest
- ▶ Format: show ip ospf route

35 Internet Protocol Version 4 (IPv4)

35.1 network

Configure the inband and outband connectivity.

35.1.1 network protocol

Select DHCP, BOOTP or none as the network configuration protocol.

- ▶ Mode: Privileged Exec Mode
- ▶ Privilege Level: Operator
- ▶ Format: network protocol <P-1>

| Parameter | Value | Meaning |
|-----------|-------|----------------------------|
| P-1 | none | No network config protocol |
| | bootp | BOOTP |
| | dhcp | DHCP |

35.1.2 network parms

Set network address, netmask and gateway

- ▶ Mode: Privileged Exec Mode
- ▶ Privilege Level: Operator
- ▶ Format: network parms <P-1> <P-2> [<P-3>]

| Parameter | Value | Meaning |
|-----------|---------|-------------|
| P-1 | A.B.C.D | IP address. |
| P-2 | A.B.C.D | IP address. |
| P-3 | A.B.C.D | IP address. |

35.2 clear

Clear several items.

35.2.1 clear arp-table-switch

Clear the agent's ARP table (cache).

- ▶ Mode: Privileged Exec Mode
- ▶ Privilege Level: Operator
- ▶ Format: clear arp-table-switch

35.3 show

Display device options and settings.

35.3.1 show network parms

Show network settings.

- ▶ **Mode:** Command is in all modes available.
- ▶ **Privilege Level:** Guest
- ▶ **Format:** show network parms

35.4 show

Display device options and settings.

35.4.1 show arp

Show ARP table.

- ▶ **Mode:** Command is in all modes available.
- ▶ **Privilege Level:** Guest
- ▶ **Format:** show arp

36 Link Backup

36.1 link-backup

Configure Link Backup parameters.

36.1.1 link-backup operation

Enable or disable Link Backup.

- ▶ Mode: Global Config Mode
- ▶ Privilege Level: Administrator
- ▶ Format: link-backup operation

■ no link-backup operation

Disable the option

- ▶ Mode: Global Config Mode
- ▶ Privilege Level: Administrator
- ▶ Format: no link-backup operation

36.2 link-backup

Configure Link Backup parameters.

36.2.1 link-backup add

Add a Link Backup interface pair.

- ▶ Mode: Interface Range Mode
- ▶ Privilege Level: Administrator
- ▶ Format: link-backup add <P-1> [failback-time <P-2>] [description <P-3>]
[failback-time]: FailBack time in seconds for the interface pair.
[description]: Description for the interface pair.

| Parameter | Value | Meaning |
|-----------|-------------------|---|
| P-1 | slot no./port no. | |
| P-2 | 0..3600 | FailBack time interval.(default: 30) |
| P-3 | string | Enter a user-defined text, max. 256 characters. |

36.2.2 link-backup delete

Delete the associated backup interface.

- ▶ Mode: Interface Range Mode
- ▶ Privilege Level: Administrator
- ▶ Format: link-backup delete <P-1>

| Parameter | Value | Meaning |
|-----------|-------------------|---------|
| P-1 | slot no./port no. | |

36.2.3 link-backup modify

Modify a Link Backup interface pair.

► **Mode:** Interface Range Mode

► **Privilege Level:** Administrator

► **Format:** link-backup modify <P-1> [failback-status <P-2>] [failback-time <P-3>] [description <P-4>] [status <P-5>]

[failback-status]: **Modify failback status.**(default: enabled)

[failback-time]: **Modify failback time.**(default: 30)

[description]: **Description for the interface pair.**

[status]: **Enable or disable a Link Backup interface pair entry.**

| Parameter | Value | Meaning |
|-----------|-------------------|---|
| P-1 | slot no./port no. | |
| P-2 | enable | Enable the option. |
| | disable | Disable the option. |
| P-3 | 0..3600 | FailBack time interval.(default: 30) |
| P-4 | string | Enter a user-defined text, max. 256 characters. |
| P-5 | enable | Enable the option. |
| | disable | Disable the option. |

36.3 show

Display device options and settings.

36.3.1 show link-backup operation

Display Link Backup global information.

- ▶ **Mode:** Command is in all modes available.
- ▶ **Privilege Level:** Guest
- ▶ **Format:** show link-backup operation

36.3.2 show link-backup pairs

Display Link Backup interface pairs.

- ▶ **Mode:** Command is in all modes available.
- ▶ **Privilege Level:** Guest
- ▶ **Format:** show link-backup pairs [<P-1>] [<P-2>]

| Parameter | Value | Meaning |
|-----------|-------------------|---------|
| P-1 | slot no./port no. | |
| P-2 | slot no./port no. | |

37 Link Layer Discovery Protocol (LLDP)

37.1 lldp

Configure of Link Layer Discovery Protocol.

37.1.1 lldp operation

Enable or disable the LLDP operational state.

- ▶ Mode: Global Config Mode
- ▶ Privilege Level: Operator
- ▶ Format: lldp operation

■ no lldp operation

Disable the option

- ▶ Mode: Global Config Mode
- ▶ Privilege Level: Operator
- ▶ Format: no lldp operation

37.1.2 lldp config chassis admin-state

Enable or disable the LLDP operational state.

- ▶ Mode: Global Config Mode
- ▶ Privilege Level: Operator
- ▶ Format: lldp config chassis admin-state <P-1>

| Parameter | Value | Meaning |
|-----------|---------|---------------------|
| P-1 | enable | Enable the option. |
| | disable | Disable the option. |

37.1.3 lldp config chassis notification-interval

Enter the LLDP notification interval in seconds.

- ▶ Mode: Global Config Mode
- ▶ Privilege Level: Operator
- ▶ Format: lldp config chassis notification-interval <P-1>

| Parameter | Value | Meaning |
|-----------|---------|------------------------------------|
| P-1 | 5..3600 | Enter a number in the given range. |

37.1.4 lldp config chassis re-init-delay

Enter the LLDP re-initialization delay in seconds.

- ▶ Mode: Global Config Mode
- ▶ Privilege Level: Operator
- ▶ Format: lldp config chassis re-init-delay <P-1>

| Parameter | Value | Meaning |
|-----------|-------|------------------------------------|
| P-1 | 1..10 | Enter a number in the given range. |

37.1.5 lldp config chassis tx-delay

Enter the LLDP transmit delay in seconds (tx-delay smaller than $(0.25 \times \text{tx-interval})$)

- ▶ Mode: Global Config Mode
- ▶ Privilege Level: Operator
- ▶ Format: lldp config chassis tx-delay <P-1>

| Parameter | Value | Meaning |
|-----------|---------|---|
| P-1 | 1..8192 | Enter a number in the given range (tx-delay smaller than $(0.25 \times \text{tx-interval})$) |

37.1.6 lldp config chassis tx-hold-multiplier

Enter the LLDP transmit hold multiplier.

- ▶ Mode: Global Config Mode
- ▶ Privilege Level: Operator
- ▶ Format: lldp config chassis tx-hold-multiplier <P-1>

| Parameter | Value | Meaning |
|-----------|-------|------------------------------------|
| P-1 | 2..10 | Enter a number in the given range. |

37.1.7 lldp config chassis tx-interval

Enter the LLDP transmit interval in seconds.

- ▶ Mode: Global Config Mode
- ▶ Privilege Level: Operator
- ▶ Format: lldp config chassis tx-interval <P-1>

| Parameter | Value | Meaning |
|-----------|----------|------------------------------------|
| P-1 | 5..32768 | Enter a number in the given range. |

37.2 show

Display device options and settings.

37.2.1 show lldp global

Display the LLDP global configurations.

- ▶ Mode: Command is in all modes available.
- ▶ Privilege Level: Guest
- ▶ Format: show lldp global

37.2.2 show lldp port

Display port specific LLDP configurations.

- ▶ Mode: Command is in all modes available.
- ▶ Privilege Level: Guest
- ▶ Format: show lldp port [<P-1>]

| Parameter | Value | Meaning |
|-----------|-------------------|---------|
| P-1 | slot no./port no. | |

37.2.3 show lldp remote-data

Remote information collected with LLDP.

- ▶ Mode: Command is in all modes available.
- ▶ Privilege Level: Guest
- ▶ Format: show lldp remote-data [<P-1>]

| Parameter | Value | Meaning |
|-----------|-------------------|---------|
| P-1 | slot no./port no. | |

37.3 lldp

Configure of Link Layer Discovery Protocol on a port.

37.3.1 lldp admin-state

Configure how the interface processes LLDP frames.

- ▶ Mode: Interface Range Mode
- ▶ Privilege Level: Operator
- ▶ Format: `lldp admin-state <P-1>`

| Parameter | Value | Meaning |
|-----------|-----------|---|
| P-1 | tx-only | Interface will only transmit LLDP frames. Received frames are not processed. |
| | rx-only | Interface will only receive LLDP frames. Frames are not transmitted. |
| | tx-and-rx | Interface will transmit and receive LLDP frames. This is the default setting. |
| | disable | Interface will neither transmit nor process received LLDP frames. |

37.3.2 lldp fdb-mode

Configure the LLDP FDB mode for this interface.

- ▶ Mode: Interface Range Mode
- ▶ Privilege Level: Operator
- ▶ Format: `lldp fdb-mode <P-1>`

| Parameter | Value | Meaning |
|-----------|-------------|--|
| P-1 | lldp-only | Collected remote data will be based on received LLDP frames only. |
| | mac-only | Collected remote data will be based on the switch's FDB entries only. |
| | both | Collected remote data will be based on received LLDP frames as well as on the switch's FDB entries. |
| | auto-detect | As long as no LLDP frames are received, the collected remote data will be based on the switch's FDB entries only. After the first LLDP frame is received, the remote data will be based on received LLDP frames only. This is the default setting. |

37.3.3 lldp max-neighbors

Enter the LLDP max neighbors for interface.

- ▶ Mode: Interface Range Mode
- ▶ Privilege Level: Operator
- ▶ Format: lldp max-neighbors <P-1>

| Parameter | Value | Meaning |
|-----------|-------|------------------------------------|
| P-1 | 1..50 | Enter a number in the given range. |

37.3.4 lldp notification

Enable or disable the LLDP notification operation for interface.

- ▶ Mode: Interface Range Mode
- ▶ Privilege Level: Operator
- ▶ Format: lldp notification

■ no lldp notification

Disable the option

- ▶ Mode: Interface Range Mode
- ▶ Privilege Level: Operator
- ▶ Format: no lldp notification

37.3.5 lldp tlv inline-power

Enable or disable inline-power TLV transmission.

- ▶ Mode: Interface Range Mode
- ▶ Privilege Level: Operator
- ▶ Format: lldp tlv inline-power <P-1>

| Parameter | Value | Meaning |
|-----------|-------|-----------------|
| P-1 | [cr] | Enable the Bit. |

■ no lldp tlv inline-power

Disable the option

- ▶ Mode: Interface Range Mode
- ▶ Privilege Level: Operator
- ▶ Format: no lldp tlv inline-power <P-1>

37.3.6 lldp tlv link-aggregation

Enable or disable link-aggregation TLV transmission.

- ▶ Mode: Interface Range Mode
- ▶ Privilege Level: Operator
- ▶ Format: lldp tlv link-aggregation <P-1>

| Parameter | Value | Meaning |
|-----------|-------|-----------------|
| P-1 | [cr] | Enable the Bit. |

■ no lldp tlv link-aggregation

Disable the option

- ▶ Mode: Interface Range Mode
- ▶ Privilege Level: Operator
- ▶ Format: no lldp tlv link-aggregation <P-1>

37.3.7 lldp tlv mac-phy-config-state

Enable or disable mac-phy-config-state TLV transmission.

- ▶ Mode: Interface Range Mode
- ▶ Privilege Level: Operator
- ▶ Format: lldp tlv mac-phy-config-state <P-1>

| Parameter | Value | Meaning |
|-----------|-------|-----------------|
| P-1 | [cr] | Enable the Bit. |

■ no lldp tlv mac-phy-config-state

Disable the option

- ▶ Mode: Interface Range Mode
- ▶ Privilege Level: Operator
- ▶ Format: no lldp tlv mac-phy-config-state <P-1>

37.3.8 lldp tlv max-frame-size

Enable or disable max-frame-size TLV transmission.

- ▶ Mode: Interface Range Mode
- ▶ Privilege Level: Operator
- ▶ Format: lldp tlv max-frame-size <P-1>

| Parameter | Value | Meaning |
|-----------|-------|-----------------|
| P-1 | [cr] | Enable the Bit. |

■ **no lldp tlv max-frame-size**

Disable the option

- ▶ Mode: Interface Range Mode
- ▶ Privilege Level: Operator
- ▶ Format: no lldp tlv max-frame-size <P-1>

37.3.9 lldp tlv mgmt-addr

Enable or disable mgmt-addr TLV transmission.

- ▶ Mode: Interface Range Mode
- ▶ Privilege Level: Operator
- ▶ Format: lldp tlv mgmt-addr

■ **no lldp tlv mgmt-addr**

Disable the option

- ▶ Mode: Interface Range Mode
- ▶ Privilege Level: Operator
- ▶ Format: no lldp tlv mgmt-addr

37.3.10 lldp tlv port-desc

Enable or disable port description TLV transmission.

- ▶ Mode: Interface Range Mode
- ▶ Privilege Level: Operator
- ▶ Format: lldp tlv port-desc <P-1>

| Parameter | Value | Meaning |
|-----------|-------|-----------------|
| P-1 | [cr] | Enable the Bit. |

■ **no lldp tlv port-desc**

Disable the option

- ▶ Mode: Interface Range Mode
- ▶ Privilege Level: Operator
- ▶ Format: no lldp tlv port-desc <P-1>

37.3.11 lldp tlv port-vlan

Enable or disable port-vlan TLV transmission.

- ▶ Mode: Interface Range Mode
- ▶ Privilege Level: Operator
- ▶ Format: lldp tlv port-vlan

■ **no lldp tlv port-vlan**

Disable the option

- ▶ Mode: Interface Range Mode
- ▶ Privilege Level: Operator
- ▶ Format: no lldp tlv port-vlan

37.3.12 lldp tlv protocol

Enable or disable protocol TLV transmission.

- ▶ Mode: Interface Range Mode
- ▶ Privilege Level: Operator
- ▶ Format: lldp tlv protocol

■ **no lldp tlv protocol**

Disable the option

- ▶ Mode: Interface Range Mode
- ▶ Privilege Level: Operator
- ▶ Format: no lldp tlv protocol

37.3.13 lldp tlv sys-cap

Enable or disable system capabilities TLV transmission.

- ▶ Mode: Interface Range Mode
- ▶ Privilege Level: Operator
- ▶ Format: lldp tlv sys-cap <P-1>

| Parameter | Value | Meaning |
|-----------|-------|-----------------|
| P-1 | [cr] | Enable the Bit. |

■ no lldp tlv sys-cap

Disable the option

- ▶ Mode: Interface Range Mode
- ▶ Privilege Level: Operator
- ▶ Format: no lldp tlv sys-cap <P-1>

37.3.14 lldp tlv sys-desc

Enable or disable system description TLV transmission.

- ▶ Mode: Interface Range Mode
- ▶ Privilege Level: Operator
- ▶ Format: lldp tlv sys-desc <P-1>

| Parameter | Value | Meaning |
|-----------|-------|-----------------|
| P-1 | [cr] | Enable the Bit. |

■ no lldp tlv sys-desc

Disable the option

- ▶ Mode: Interface Range Mode
- ▶ Privilege Level: Operator
- ▶ Format: no lldp tlv sys-desc <P-1>

37.3.15 lldp tlv sys-name

Enable or disable system name TLV transmission.

- ▶ Mode: Interface Range Mode
- ▶ Privilege Level: Operator
- ▶ Format: lldp tlv sys-name <P-1>

| Parameter | Value | Meaning |
|-----------|-------|-----------------|
| P-1 | [cr] | Enable the Bit. |

■ **no lldp tlv sys-name**

Disable the option

- ▶ Mode: Interface Range Mode
- ▶ Privilege Level: Operator
- ▶ Format: no lldp tlv sys-name <P-1>

37.3.16 lldp tlv vlan-name

Enable or disable vlan name TLV transmission.

- ▶ Mode: Interface Range Mode
- ▶ Privilege Level: Operator
- ▶ Format: lldp tlv vlan-name

■ **no lldp tlv vlan-name**

Disable the option

- ▶ Mode: Interface Range Mode
- ▶ Privilege Level: Operator
- ▶ Format: no lldp tlv vlan-name

37.3.17 lldp tlv protocol-based-vlan

Enable or disable protocol-based vlan TLV transmission.

- ▶ Mode: Interface Range Mode
- ▶ Privilege Level: Operator
- ▶ Format: lldp tlv protocol-based-vlan

■ **no lldp tlv protocol-based-vlan**

Disable the option

- ▶ Mode: Interface Range Mode
- ▶ Privilege Level: Operator
- ▶ Format: no lldp tlv protocol-based-vlan

37.3.18 lldp tlv igmp

Enable or disable igmp TLV transmission.

- ▶ Mode: Interface Range Mode
- ▶ Privilege Level: Operator
- ▶ Format: lldp tlv igmp

■ no lldp tlv igmp

Disable the option

- ▶ Mode: Interface Range Mode
- ▶ Privilege Level: Operator
- ▶ Format: no lldp tlv igmp

37.3.19 lldp tlv portsec

Enable or disable portsec TLV transmission.

- ▶ Mode: Interface Range Mode
- ▶ Privilege Level: Operator
- ▶ Format: lldp tlv portsec

■ no lldp tlv portsec

Disable the option

- ▶ Mode: Interface Range Mode
- ▶ Privilege Level: Operator
- ▶ Format: no lldp tlv portsec

37.3.20 lldp tlv ptp

Enable or disable PTP TLV transmission.

- ▶ Mode: Interface Range Mode
- ▶ Privilege Level: Operator
- ▶ Format: lldp tlv ptp

■ **no lldp tlv ptp**

Disable the option

- ▶ Mode: Interface Range Mode
- ▶ Privilege Level: Operator
- ▶ Format: no lldp tlv ptp

37.3.21 lldp tlv pnio

Enable or disable PROFINET TLV transmission.

- ▶ Mode: Interface Range Mode
- ▶ Privilege Level: Operator
- ▶ Format: lldp tlv pnio

■ **no lldp tlv pnio**

Disable the option

- ▶ Mode: Interface Range Mode
- ▶ Privilege Level: Operator
- ▶ Format: no lldp tlv pnio

37.3.22 lldp tlv pnio-alias

Enable or disable PROFINET alias TLV transmission.

- ▶ Mode: Interface Range Mode
- ▶ Privilege Level: Operator
- ▶ Format: lldp tlv pnio-alias

■ **no lldp tlv pnio-alias**

Disable the option

- ▶ Mode: Interface Range Mode
- ▶ Privilege Level: Operator
- ▶ Format: no lldp tlv pnio-alias

37.3.23 lldp tlv pnio-mrp

Enable or disable PROFINET MRP TLV transmission.

- ▶ **Mode:** Interface Range Mode
- ▶ **Privilege Level:** Operator
- ▶ **Format:** lldp tlv pnio-mrp

■ **no lldp tlv pnio-mrp**

Disable the option

- ▶ **Mode:** Interface Range Mode
- ▶ **Privilege Level:** Operator
- ▶ **Format:** no lldp tlv pnio-mrp

38 Media Endpoint Discovery LLDP-MED

38.1 lldp

Configure of Link Layer Discovery Protocol on a port.

38.1.1 lldp med confignotification

Enable or disable LLDP-MED notification send for this interface.

- ▶ Mode: Interface Range Mode
- ▶ Privilege Level: Operator
- ▶ Format: lldp med confignotification

■ no lldp med confignotification

Disable the option

- ▶ Mode: Interface Range Mode
- ▶ Privilege Level: Operator
- ▶ Format: no lldp med confignotification

38.1.2 lldp med transmit-tlv capabilities

Include/Exclude LLDP MED capabilities TLV.

- ▶ Mode: Interface Range Mode
- ▶ Privilege Level: Operator
- ▶ Format: lldp med transmit-tlv capabilities

■ no lldp med transmit-tlv capabilities

Disable the option

- ▶ Mode: Interface Range Mode
- ▶ Privilege Level: Operator
- ▶ Format: no lldp med transmit-tlv capabilities

38.1.3 lldp med transmit-tlv network-policy

Include/Exclude LLDP network policy TLV.

- ▶ **Mode:** Interface Range Mode
- ▶ **Privilege Level:** Operator
- ▶ **Format:** lldp med transmit-tlv network-policy

■ **no lldp med transmit-tlv network-policy**

Disable the option

- ▶ **Mode:** Interface Range Mode
- ▶ **Privilege Level:** Operator
- ▶ **Format:** no lldp med transmit-tlv network-policy

38.2 lldp

Configure of Link Layer Discovery Protocol.

38.2.1 lldp med faststartrepeatcount

Configure LLDP-MED fast start repeat count.

- ▶ Mode: Global Config Mode
- ▶ Privilege Level: Operator
- ▶ Format: `lldp med faststartrepeatcount <P-1>`

| Parameter | Value | Meaning |
|-----------|-------|--|
| P-1 | 1..10 | Enter a value representing the number of LLDP PDUs that will be transmitted. Default is 3. |

38.3 show

Display device options and settings.

38.3.1 show lldp med global

Display a summary of the current LLDP-MED configuration.

- ▶ Mode: Command is in all modes available.
- ▶ Privilege Level: Guest
- ▶ Format: show lldp med global

38.3.2 show lldp med interface

Display the current LLDP-MED configuration on a specific port.

- ▶ Mode: Command is in all modes available.
- ▶ Privilege Level: Guest
- ▶ Format: show lldp med interface [<P-1>]

| Parameter | Value | Meaning |
|-----------|-------------------|---------|
| P-1 | slot no./port no. | |

38.3.3 show lldp med local-device

Display detailed information about the LLDP-MED data

- ▶ Mode: Command is in all modes available.
- ▶ Privilege Level: Guest
- ▶ Format: show lldp med local-device <P-1>

| Parameter | Value | Meaning |
|-----------|-------------------|---------|
| P-1 | slot no./port no. | |

38.3.4 show lldp med remote-device detail

Display LLDP-MED detail configuration for a remote device.

- ▶ Mode: Command is in all modes available.
- ▶ Privilege Level: Guest
- ▶ Format: show lldp med remote-device detail <P-1>

| Paramete | Value | Meaning |
|----------|-------------------|---------|
| P-1 | slot no./port no. | |

38.3.5 show lldp med remote-device summary

Display LLDP-MED summary configuration for a remote device.

- ▶ Mode: Command is in all modes available.
- ▶ Privilege Level: Guest
- ▶ Format: show lldp med remote-device summary [<P-1>]

| Paramete | Value | Meaning |
|----------|-------------------|---------|
| P-1 | slot no./port no. | |

39 Logging

39.1 logging

Logging configuration.

39.1.1 logging audit-trail

Add a comment for the audit trail.

- ▶ Mode: Global Config Mode
- ▶ Privilege Level: Administrator
- ▶ Format: logging audit-trail <P-1>

| Parameter | Value | Meaning |
|-----------|--------|--|
| P-1 | string | Enter a user-defined text, max. 80 characters. |

39.1.2 logging buffered severity

Configure the minimum severity level to be logged to the high priority buffer.

- ▶ Mode: Global Config Mode
- ▶ Privilege Level: Administrator
- ▶ Format: logging buffered severity <P-1>

| Parameter | Value | Meaning |
|-----------|---------------|--|
| P-1 | emergency | System is unusable. System failure has occurred. |
| | alert | Action must be taken immediately. Unrecoverable failure of a component. System failure likely. |
| | critical | Recoverable failure of a component that may lead to system failure. |
| | error | Error conditions. Recoverable failure of a component. |
| | warning | Minor failure, e.g. misconfiguration of a component. |
| | notice | Normal but significant conditions. |
| | informational | Informational messages. |
| | debug | Debug-level messages. |
| | 0 | Same as emergency |
| | 1 | Same as alert |
| | 2 | Same as critical |

39.1.3 logging host add

Add a new logging host.

- ▶ Mode: Global Config Mode
 - ▶ Privilege Level: Administrator
 - ▶ Format: logging host add <P-1> addr <P-2> <P-3> [transport <P-4>] [port <P-5>] [severity <P-6>] [type <P-7>]
- addr: Enter the IP address of the server.
 [transport]: Configure the type of transport used for syslog server transmission.
 [port]: Enter the port used for syslog server transmission.
 [severity]: Configure the minimum severity level to be sent to this syslog server.
 [type]: Configure the type of log messages to be sent to the syslog server.

| Parameter | Value | Meaning |
|------------|-----------------------------|--|
| P-1 | 1..8 | Syslog server entry index |
| P-2 | string | Hostname or IP address. |
| P-3 | a.b.c.d | IP address. |
| P-4 | udp | The UDP-based transmission. |
| | tls | The TLS-based transmission. |
| P-5 | 1..65535 | Port number to be used |
| P-6 | emergency | System is unusable. System failure has occurred. |
| | alert | Action must be taken immediately. Unrecoverable failure of a component. System failure likely. |
| | critical | Recoverable failure of a component that may lead to system failure. |
| | error | Error conditions. Recoverable failure of a component. |
| | warning | Minor failure, e.g. misconfiguration of a component. |
| | notice | Normal but significant conditions. |
| | informational | Informational messages. |
| | debug | Debug-level messages. |
| | 0 | Same as emergency |
| | 1 | Same as alert |
| P-7 | 2 | Same as critical |
| | 3 | Same as error |
| | 4 | Same as warning |
| | 5 | Same as notice |
| | 6 | Same as informational |
| | 7 | Same as debug |
| | systemlog | the system event log entries |
| audittrail | the audit trail log entries | |

39.1.4 logging host delete

Delete a logging host.

- ▶ Mode: Global Config Mode
- ▶ Privilege Level: Administrator
- ▶ Format: logging host delete <P-1>

| Parameter | Value | Meaning |
|-----------|-------|---------------------------|
| P-1 | 1..8 | Syslog server entry index |

39.1.5 logging host enable

Enable a logging host.

- ▶ Mode: Global Config Mode
- ▶ Privilege Level: Administrator
- ▶ Format: logging host enable <P-1>

| Paramete | Value | Meaning |
|----------|-------|---------------------------|
| P-1 | 1..8 | Syslog server entry index |

39.1.6 logging host disable

Disable a logging host.

- ▶ Mode: Global Config Mode
- ▶ Privilege Level: Administrator
- ▶ Format: logging host disable <P-1>

| Paramete | Value | Meaning |
|----------|-------|---------------------------|
| P-1 | 1..8 | Syslog server entry index |

39.1.7 logging host modify

Modify an existing logging host.

- ▶ Mode: Global Config Mode
- ▶ Privilege Level: Administrator
- ▶ Format: logging host modify <P-1> [addr <P-2> <P-3>] [transport <P-4>] [port <P-5>] [severity <P-6>] [type <P-7>]

[addr]: Enter the IP address of the server.

[transport]: Configure the type of transport used for syslog server transmission.

[port]: Enter the port used for syslog server transmission.

[severity]: Configure the minimum severity level to be sent to this syslog server.

[type]: Configure the type of log messages to be sent to the syslog server.

| Paramete | Value | Meaning |
|----------|----------|-----------------------------|
| P-1 | 1..8 | Syslog server entry index |
| P-2 | string | Hostname or IP address. |
| P-3 | a.b.c.d | IP address. |
| P-4 | udp | The UDP-based transmission. |
| | tls | The TLS-based transmission. |
| P-5 | 1..65535 | Port number to be used |

| Parameter | Value | Meaning |
|-----------|-----------------------|--|
| P-6 | emergency | System is unusable. System failure has occurred. |
| | alert | Action must be taken immediately. Unrecoverable failure of a component. System failure likely. |
| | critical | Recoverable failure of a component that may lead to system failure. |
| | error | Error conditions. Recoverable failure of a component. |
| | warning | Minor failure, e.g. misconfiguration of a component. |
| | notice | Normal but significant conditions. |
| | informational | Informational messages. |
| | debug | Debug-level messages. |
| | 0 | Same as emergency |
| | 1 | Same as alert |
| | 2 | Same as critical |
| | 3 | Same as error |
| | 4 | Same as warning |
| | 5 | Same as notice |
| 6 | Same as informational | |
| 7 | Same as debug | |
| P-7 | systemlog | the system event log entries |
| | audittrail | the audit trail log entries |

39.1.8 logging syslog operation

Enable or disable the syslog client.

- ▶ Mode: Global Config Mode
- ▶ Privilege Level: Administrator
- ▶ Format: logging syslog operation

■ no logging syslog operation

Disable the option

- ▶ Mode: Global Config Mode
- ▶ Privilege Level: Administrator
- ▶ Format: no logging syslog operation

39.1.9 logging current-console operation

Enable or disable logging messages to the current remote console.

- ▶ Mode: Global Config Mode
- ▶ Privilege Level: Administrator
- ▶ Format: logging current-console operation

■ no logging current-console operation

Disable the option

- ▶ Mode: Global Config Mode
- ▶ Privilege Level: Administrator
- ▶ Format: no logging current-console operation

39.1.10 logging current-console severity

Configure the minimum severity level to be sent to the current remote console.

- ▶ Mode: Global Config Mode
- ▶ Privilege Level: Administrator
- ▶ Format: logging current-console severity <P-1>

| Parameter | Value | Meaning |
|-----------|---------------|--|
| P-1 | emergency | System is unusable. System failure has occurred. |
| | alert | Action must be taken immediately. Unrecoverable failure of a component. System failure likely. |
| | critical | Recoverable failure of a component that may lead to system failure. |
| | error | Error conditions. Recoverable failure of a component. |
| | warning | Minor failure, e.g. misconfiguration of a component. |
| | notice | Normal but significant conditions. |
| | informational | Informational messages. |
| | debug | Debug-level messages. |
| | 0 | Same as emergency |
| | 1 | Same as alert |
| | 2 | Same as critical |
| | 3 | Same as error |
| | 4 | Same as warning |
| | 5 | Same as notice |
| | 6 | Same as informational |
| 7 | Same as debug | |

39.1.11 logging console operation

Enable or disable logging to the local V.24 console.

- ▶ Mode: Global Config Mode
- ▶ Privilege Level: Administrator
- ▶ Format: logging console operation

■ no logging console operation

Disable the option

- ▶ Mode: Global Config Mode
- ▶ Privilege Level: Administrator
- ▶ Format: no logging console operation

39.1.12 logging console severity

Configure the minimum severity level to be logged to the V.24 console.

- ▶ Mode: Global Config Mode
- ▶ Privilege Level: Administrator
- ▶ Format: logging console severity <P-1>

| Parameter | Value | Meaning |
|-----------|---------------|--|
| P-1 | emergency | System is unusable. System failure has occurred. |
| | alert | Action must be taken immediately. Unrecoverable failure of a component. System failure likely. |
| | critical | Recoverable failure of a component that may lead to system failure. |
| | error | Error conditions. Recoverable failure of a component. |
| | warning | Minor failure, e.g. misconfiguration of a component. |
| | notice | Normal but significant conditions. |
| | informational | Informational messages. |
| | debug | Debug-level messages. |
| | 0 | Same as emergency |
| | 1 | Same as alert |
| | 2 | Same as critical |
| | 3 | Same as error |
| | 4 | Same as warning |
| | 5 | Same as notice |
| | 6 | Same as informational |
| 7 | Same as debug | |

39.1.13 logging persistent operation

Enable or disable persistent logging. This feature is only available when an ENVM is connected to the device. The logging information is saved on the selected ENVM.

- ▶ Mode: Global Config Mode
- ▶ Privilege Level: Administrator
- ▶ Format: logging persistent operation

■ no logging persistent operation

Disable the option

- ▶ Mode: Global Config Mode
- ▶ Privilege Level: Administrator
- ▶ Format: no logging persistent operation

39.1.14 logging persistent numfiles

Enter the maximum number of log files.

- ▶ Mode: Global Config Mode
- ▶ Privilege Level: Administrator
- ▶ Format: logging persistent numfiles <P-1>

| Paramete | Value | Meaning |
|----------|-------|--------------------|
| P-1 | 0..25 | number of logfiles |

39.1.15 logging persistent filesize

Enter the maximum size of a log file.

- ▶ Mode: Global Config Mode
- ▶ Privilege Level: Administrator
- ▶ Format: logging persistent filesize <P-1>

| Paramete | Value | Meaning |
|----------|---------|--|
| P-1 | 0..4096 | Maximum persistent logfile size on the non-volatile memory in kBytes |

39.1.16 logging persistent severity-level

Configure the minimum severity level to be logged into files.

- ▶ Mode: Global Config Mode
- ▶ Privilege Level: Administrator
- ▶ Format: logging persistent severity-level <P-1>

| Parameter | Value | Meaning |
|-----------|-----------------------|--|
| P-1 | emergency | System is unusable. System failure has occurred. |
| | alert | Action must be taken immediately. Unrecoverable failure of a component. System failure likely. |
| | critical | Recoverable failure of a component that may lead to system failure. |
| | error | Error conditions. Recoverable failure of a component. |
| | warning | Minor failure, e.g. misconfiguration of a component. |
| | notice | Normal but significant conditions. |
| | informational | Informational messages. |
| | debug | Debug-level messages. |
| | 0 | Same as emergency |
| | 1 | Same as alert |
| | 2 | Same as critical |
| | 3 | Same as error |
| | 4 | Same as warning |
| | 5 | Same as notice |
| 6 | Same as informational | |
| 7 | Same as debug | |

39.1.17 logging email operation

Enable or disable logging email-alert globally.

- ▶ Mode: Global Config Mode
- ▶ Privilege Level: Administrator
- ▶ Format: logging email operation

■ no logging email operation

Disable the option

- ▶ Mode: Global Config Mode
- ▶ Privilege Level: Administrator
- ▶ Format: no logging email operation

39.1.18 logging email from-addr

Configure mail address used by device to send email-alert.

- ▶ Mode: Global Config Mode
- ▶ Privilege Level: Administrator
- ▶ Format: logging email from-addr <P-1>

| Parameter | Value | Meaning |
|-----------|--------|-----------------------------|
| P-1 | string | Enter a valid email address |

39.1.19 logging email duration

Periodic timer (in minutes) to send an non-critical logs in mail.

- ▶ Mode: Global Config Mode
- ▶ Privilege Level: Administrator
- ▶ Format: logging email duration <P-1>

| Parameter | Value | Meaning |
|-----------|----------|--------------------------|
| P-1 | 30..1440 | Time duration in minutes |

39.1.20 logging email severity urgent

Urgent severity level

- ▶ Mode: Global Config Mode
- ▶ Privilege Level: Administrator
- ▶ Format: logging email severity urgent <P-1>

| Parameter | Value | Meaning |
|-----------|---------------|--|
| P-1 | emergency | System is unusable. System failure has occurred. |
| | alert | Action must be taken immediately. Unrecoverable failure of a component. System failure likely. |
| | critical | Recoverable failure of a component that may lead to system failure. |
| | error | Error conditions. Recoverable failure of a component. |
| | warning | Minor failure, e.g. misconfiguration of a component. |
| | notice | Normal but significant conditions. |
| | informational | Informational messages. |
| | debug | Debug-level messages. |
| | 0 | Same as emergency |
| | 1 | Same as alert |
| | 2 | Same as critical |
| | 3 | Same as error |
| | 4 | Same as warning |
| | 5 | Same as notice |
| | 6 | Same as informational |
| | 7 | Same as debug |

39.1.21 logging email severity non-urgent

Non-urgent severity level

- ▶ Mode: Global Config Mode
- ▶ Privilege Level: Administrator
- ▶ Format: logging email severity non-urgent <P-1>

| Parameter | Value | Meaning |
|-----------|-----------------------|--|
| P-1 | emergency | System is unusable. System failure has occurred. |
| | alert | Action must be taken immediately. Unrecoverable failure of a component. System failure likely. |
| | critical | Recoverable failure of a component that may lead to system failure. |
| | error | Error conditions. Recoverable failure of a component. |
| | warning | Minor failure, e.g. misconfiguration of a component. |
| | notice | Normal but significant conditions. |
| | informational | Informational messages. |
| | debug | Debug-level messages. |
| | 0 | Same as emergency |
| | 1 | Same as alert |
| | 2 | Same as critical |
| 3 | Same as error | |
| 4 | Same as warning | |
| 5 | Same as notice | |
| 6 | Same as informational | |
| 7 | Same as debug | |

39.1.22 logging email to-addr add

Create a destination address entry with default values

- ▶ Mode: Global Config Mode
- ▶ Privilege Level: Administrator
- ▶ Format: logging email to-addr add <P-1> [addr <P-2>] [msgtype <P-3>]

[addr]: Create an entry with specified address

[msgtype]: Create an entry with specified message type

| Parameter | Value | Meaning |
|-----------|------------|---------------------------------|
| P-1 | 1..10 | Destination address entry index |
| P-2 | string | Enter a valid email address |
| P-3 | urgent | Urgent message type |
| | non-urgent | Non-urgent message type |

39.1.23 logging email to-addr delete

Delete a destination address

- ▶ Mode: Global Config Mode
- ▶ Privilege Level: Administrator
- ▶ Format: logging email to-addr delete <P-1>

| Parameter | Value | Meaning |
|-----------|-------|---------------------------------|
| P-1 | 1..10 | Destination address entry index |

39.1.24 logging email to-addr modify

Modify a destination address

- ▶ Mode: Global Config Mode
 - ▶ Privilege Level: Administrator
 - ▶ Format: logging email to-addr modify <P-1> [addr <P-2>] [msgtype <P-3>]
- [addr]: Modify the destination address
[msgtype]: Modify the message type

| Parameter | Value | Meaning |
|-----------|------------|---------------------------------|
| P-1 | 1..10 | Destination address entry index |
| P-2 | string | Enter a valid email address |
| P-3 | urgent | Urgent message type |
| | non-urgent | Non-urgent message type |

39.1.25 logging email mail-server add

Add a server entry to SMTP address table

- ▶ Mode: Global Config Mode
 - ▶ Privilege Level: Administrator
 - ▶ Format: logging email mail-server add <P-1> [addr <P-2>] [security <P-3>] [username <P-4>] [password <P-5>] [port <P-6>] [timeout <P-7>] [description <P-8>]
- [addr]: SMTP server address
[security]: Security mode used in SMTP server.
[username]: Login ID to access SMTP server.
[password]: Password to access SMTP server.
[port]: SMTP server port number.
[timeout]: SMTP server connection timeout
[description]: SMTP server description

| Parameter | Value | Meaning |
|-----------|----------|--|
| P-1 | 1..5 | SMTP server index |
| P-2 | string | Hostname or IP address. |
| P-3 | none | Security mode none |
| | tlsv1 | Security mode TLSv1 |
| P-4 | string | Enter a user-defined text, max. 32 characters. |
| P-5 | string | Enter a user-defined text, max. 32 characters. |
| P-6 | 1..65535 | Port number to be used |
| P-7 | 1..15 | SMTP server timeout range |
| P-8 | string | Enter a user-defined text, max. 1024 characters (allowed characters are from ASCII 32 to 127). |

39.1.26 logging email mail-server delete

Delete a server entry from SMTP address table

- ▶ Mode: Global Config Mode
- ▶ Privilege Level: Administrator
- ▶ Format: logging email mail-server delete <P-1>

| Parameter | Value | Meaning |
|-----------|-------|-------------------|
| P-1 | 1..5 | SMTP server index |

39.1.27 logging email mail-server modify

Modify an SMTP server entry

- ▶ Mode: Global Config Mode
- ▶ Privilege Level: Administrator
- ▶ Format: logging email mail-server modify <P-1> [addr <P-2>] [security <P-3>] [username <P-4>] [password <P-5>] [port <P-6>] [timeout <P-7>] [description <P-8>]

[addr]: SMTP server address
 [security]: Security mode used in SMTP server.
 [username]: Login ID to access SMTP server.
 [password]: Password to access SMTP server.
 [port]: SMTP server port number.
 [timeout]: SMTP Timeout
 [description]: SMTP server description

| Parameter | Value | Meaning |
|-----------|--------|-------------------------|
| P-1 | 1..5 | SMTP server index |
| P-2 | string | Hostname or IP address. |

| Parameter | Value | Meaning |
|-----------|----------|--|
| P-3 | none | Security mode none |
| | tlsv1 | Security mode TLSv1 |
| P-4 | string | Enter a user-defined text, max. 32 characters. |
| P-5 | string | Enter a user-defined text, max. 32 characters. |
| P-6 | 1..65535 | Port number to be used |
| P-7 | 1..15 | SMTP server timeout range |
| P-8 | string | Enter a user-defined text, max. 1024 characters (allowed characters are from ASCII 32 to 127). |

39.1.28 logging email subject add

Create an email subject entry

- ▶ Mode: Global Config Mode
- ▶ Privilege Level: Administrator
- ▶ Format: logging email subject add <P-1> [<P-2>]

| Parameter | Value | Meaning |
|-----------|------------|---|
| P-1 | urgent | Urgent message type |
| | non-urgent | Non-urgent message type |
| P-2 | string | <string> Enter the email subject (Within double quotations if subject includes space) |

39.1.29 logging email subject delete

Delete an email subject entry

- ▶ Mode: Global Config Mode
- ▶ Privilege Level: Administrator
- ▶ Format: logging email subject delete <P-1>

| Parameter | Value | Meaning |
|-----------|------------|-------------------------|
| P-1 | urgent | Urgent message type |
| | non-urgent | Non-urgent message type |

39.1.30 logging email subject modify

Modify an email subject entry

- ▶ Mode: Global Config Mode
- ▶ Privilege Level: Administrator
- ▶ Format: logging email subject modify <P-1> <P-2>

| Parameter | Value | Meaning |
|-----------|------------|---|
| P-1 | urgent | Urgent message type |
| | non-urgent | Non-urgent message type |
| P-2 | string | <string> Enter the email subject (Within double quotations if subject includes space) |

39.1.31 logging email test msgtype

Configure the message type for test mail.

- ▶ Mode: Global Config Mode
- ▶ Privilege Level: Administrator
- ▶ Format: logging email test msgtype <P-1> <P-2>

| Parameter | Value | Meaning |
|-----------|------------|---|
| P-1 | urgent | Urgent message type |
| | non-urgent | Non-urgent message type |
| P-2 | string | Enter a user-defined text, max. 255 characters. |

39.2 show

Display device options and settings.

39.2.1 show logging buffered

Display buffered (in-memory) log entries.

- ▶ **Mode:** Command is in all modes available.
- ▶ **Privilege Level:** Guest
- ▶ **Format:** show logging buffered [<P-1>]

| Parameter | Value | Meaning |
|-----------|--------|---|
| P-1 | string | <filter> Enter a comma separated list of severity ranges, numbers or enum strings are allowed. Example: 0-1,informational-debug |

39.2.2 show logging traplogs

Display trap log entries.

- ▶ **Mode:** Command is in all modes available.
- ▶ **Privilege Level:** Guest
- ▶ **Format:** show logging traplogs

39.2.3 show logging console

Display console logging configurations.

- ▶ **Mode:** Command is in all modes available.
- ▶ **Privilege Level:** Guest
- ▶ **Format:** show logging console

39.2.4 show logging persistent

Display persistent logging configurations.

- ▶ Mode: Command is in all modes available.
- ▶ Privilege Level: Guest
- ▶ Format: show logging persistent [logfiles] [logfiles]: List the persistent log files.

39.2.5 show logging syslog

Display current syslog operational setting.

- ▶ Mode: Command is in all modes available.
- ▶ Privilege Level: Guest
- ▶ Format: show logging syslog

39.2.6 show logging host

Display a list of logging hosts currently configured.

- ▶ Mode: Command is in all modes available.
- ▶ Privilege Level: Guest
- ▶ Format: show logging host

39.2.7 show logging email statistics

Display the statistics of email logging.

- ▶ Mode: Command is in all modes available.
- ▶ Privilege Level: Guest
- ▶ Format: show logging email statistics

39.2.8 show logging email global

Display global settings of email logging feature.

- ▶ Mode: Command is in all modes available.
- ▶ Privilege Level: Guest
- ▶ Format: show logging email global

39.2.9 show logging email to-addr

Display list of destination addresses configured.

- ▶ Mode: Command is in all modes available.
- ▶ Privilege Level: Guest
- ▶ Format: show logging email to-addr [<P-1>]

| Parameter | Value | Meaning |
|-----------|-------|---------------------------------|
| P-1 | 1..10 | Destination address entry index |

39.2.10 show logging email subject

Display the subject entries configured.

- ▶ Mode: Command is in all modes available.
- ▶ Privilege Level: Guest
- ▶ Format: show logging email subject [<P-1>]

| Parameter | Value | Meaning |
|-----------|------------|-------------------------|
| P-1 | urgent | Urgent message type |
| | non-urgent | Non-urgent message type |

39.2.11 show logging email mail-server

Display SMTP server settings.

- ▶ Mode: Command is in all modes available.
- ▶ Privilege Level: Guest
- ▶ Format: show logging email mail-server [<P-1>]

| Parameter | Value | Meaning |
|-----------|-------|-------------------|
| P-1 | 1..5 | SMTP server index |

39.3 copy

Copy different kinds of items.

39.3.1 copy eventlog buffered envm

Copy a buffered log from the device to external non-volatile memory.

- ▶ Mode: Privileged Exec Mode
- ▶ Privilege Level: Operator
- ▶ Format: copy eventlog buffered envm <P-1>

| Parameter | Value | Meaning |
|-----------|--------|--|
| P-1 | string | Enter a user-defined text, max. 32 characters. |

39.3.2 copy eventlog buffered remote

Copy a buffered log from the device to a file server.

- ▶ Mode: Privileged Exec Mode
- ▶ Privilege Level: Operator
- ▶ Format: copy eventlog buffered remote <P-1>

| Parameter | Value | Meaning |
|-----------|--------|---|
| P-1 | string | Enter a user-defined text, max. 128 characters. |

39.3.3 copy eventlog persistent

Copy the persistent logs from the device to an envm or a file server.

- ▶ Mode: Privileged Exec Mode
- ▶ Privilege Level: Operator
- ▶ Format: copy eventlog persistent <P-1> envm <P-2> remote <P-3>

envm: Copy the persistent log from the device to external non-volatile memory.

remote: Copy the persistent logs from the device to a file server.

| Parameter | Value | Meaning |
|-----------|--------|---|
| P-1 | string | Enter a user-defined text, max. 32 characters. |
| P-2 | string | Enter a user-defined text, max. 32 characters. |
| P-3 | string | Enter a user-defined text, max. 128 characters. |

39.3.4 copy traplog system envm

Copy the traplog from the device to external non-volatile memory.

- ▶ Mode: Privileged Exec Mode
- ▶ Privilege Level: Operator
- ▶ Format: copy traplog system envm <P-1>

| Parameter | Value | Meaning |
|-----------|--------|--|
| P-1 | string | Enter a user-defined text, max. 32 characters. |

39.3.5 copy traplog system remote

Copy the traplog from the device to a file server

- ▶ Mode: Privileged Exec Mode
- ▶ Privilege Level: Operator
- ▶ Format: copy traplog system remote <P-1>

| Parameter | Value | Meaning |
|-----------|--------|---|
| P-1 | string | Enter a user-defined text, max. 128 characters. |

39.3.6 copy audittrail system envm

Copy the audit trail from the device to external non-volatile memory.

- ▶ Mode: Privileged Exec Mode
- ▶ Privilege Level: Operator, Auditor
- ▶ Format: copy audittrail system envm <P-1>

| Parameter | Value | Meaning |
|-----------|--------|--|
| P-1 | string | Enter a user-defined text, max. 32 characters. |

39.3.7 copy audittrail system remote

Copy the audit trail from the device to a file server.

- ▶ Mode: Privileged Exec Mode
- ▶ Privilege Level: Operator, Auditor
- ▶ Format: copy audittrail system remote <P-1>

| Parameter | Value | Meaning |
|-----------|--------|---|
| P-1 | string | Enter a user-defined text, max. 128 characters. |

39.3.8 copy mailcert remote

Copy CA certificate file (*.pem) from the remote AD server to the specified destination.

- ▶ Mode: Privileged Exec Mode
- ▶ Privilege Level: Administrator
- ▶ Format: copy mailcert remote <P-1> nvm [<P-2>]

nvm: Copy CA certificate file (*.pem) from the remote AD server to the device.

| Parameter | Value | Meaning |
|-----------|--------|---|
| P-1 | string | Enter a user-defined text, max. 128 characters. |
| P-2 | string | Enter a user-defined text, max. 100 characters. |

39.3.9 copy mailcert envm

Copy CA certificate file (*.pem) from external non-volatile memory to the specified destination.

- ▶ Mode: Privileged Exec Mode
- ▶ Privilege Level: Administrator
- ▶ Format: copy mailcert envm <P-1> nvm [<P-2>]

nvm: Copy CA certificate file (*.pem) from external non-volatile memory to the device.

| Parameter | Value | Meaning |
|-----------|--------|---|
| P-1 | string | Enter a user-defined text, max. 128 characters. |
| P-2 | string | Enter a user-defined text, max. 100 characters. |

39.3.10 copy syslogcacert remote

Copy CA certificate file (*.pem) from the remote AD server to the specified destination.

- ▶ Mode: Privileged Exec Mode
- ▶ Privilege Level: Administrator
- ▶ Format: copy syslogcacert remote <P-1> nvm [<P-2>]

nvm: Copy CA certificate file (*.pem) from the remote AD server to the device.

| Parameter | Value | Meaning |
|-----------|--------|---|
| P-1 | string | Enter a user-defined text, max. 128 characters. |
| P-2 | string | Enter a user-defined text, max. 100 characters. |

39.3.11 copy syslogcacert envm

Copy CA certificate file (*.pem) from external non-volatile memory to the specified destination.

- ▶ Mode: Privileged Exec Mode
- ▶ Privilege Level: Administrator
- ▶ Format: copy syslogcacert envm <P-1> nvm [<P-2>]

nvm: Copy CA certificate file (*.pem) from external non-volatile memory to the device.

| Parameter | Value | Meaning |
|-----------|--------|---|
| P-1 | string | Enter a user-defined text, max. 128 characters. |
| P-2 | string | Enter a user-defined text, max. 100 characters. |

39.4 clear

Clear several items.

39.4.1 clear logging buffered

Clear buffered log from memory.

- ▶ Mode: Privileged Exec Mode
- ▶ Privilege Level: Administrator
- ▶ Format: clear logging buffered

39.4.2 clear logging persistent

Clear persistent log from memory.

- ▶ Mode: Privileged Exec Mode
- ▶ Privilege Level: Administrator
- ▶ Format: clear logging persistent

39.4.3 clear logging email statistics

Clear email statistics

- ▶ Mode: Privileged Exec Mode
- ▶ Privilege Level: Administrator
- ▶ Format: clear logging email statistics

39.4.4 clear eventlog

Clear the event log entries from memory.

- ▶ Mode: Privileged Exec Mode
- ▶ Privilege Level: Administrator
- ▶ Format: clear eventlog

40 Parallel Redundancy Protocol (PRP)

40.1 prp

Configure parallel redundancy protocol (PRP) parameters and clear tables and counters.

40.1.1 prp operation

Enable or disable the parallel redundancy protocol (PRP).

- ▶ Mode: Global Config Mode
- ▶ Privilege Level: Operator
- ▶ Format: prp operation

■ no prp operation

Disable the option

- ▶ Mode: Global Config Mode
- ▶ Privilege Level: Operator
- ▶ Format: no prp operation

40.1.2 prp instance

Configure PRP instances

- ▶ Mode: Global Config Mode
- ▶ Privilege Level: Operator
- ▶ Format: prp instance <P-1> operation port-a port-b supervision evaluate send redbox-exclusively speed <P-2>

operation: Enable or disable the PRP instance.

port-a: Enable or disable the first port of the PRP line.

port-b: Enable or disable the second port of the PRP line.

supervision: Configure the PRP supervision tx and rx packet handling.

evaluate: Enable or disable evaluation of received supervision packets.

send: Enable or disable sending of supervision packets.

redbox-exclusively: Enable sending of supervision packets for this RedBox exclusively. Use the no form of the command to send supervision packets for each connected VDAN and this RedBox (if send is enabled).

speed: Configure the speed of LRE interfaces.

| Parameter | Value | Meaning |
|-----------|-------|---|
| P-1 | 1..1 | Enter PRP instance number (only 1 supported). |

| Parameter | Value | Meaning |
|-----------|-------|-------------|
| P-2 | 100 | 100 MBit/s |
| | 1000 | 1000 MBit/s |

■ **no prp instance**

Disable the option

- ▶ **Mode:** Global Config Mode
- ▶ **Privilege Level:** Operator
- ▶ **Format:** no prp instance <P-1> operation port-a port-b supervision evaluate send redbox-exclusively speed

40.2 show

Display device options and settings.

40.2.1 show prp global

Show global preferences.

- ▶ Mode: Command is in all modes available.
- ▶ Privilege Level: Guest
- ▶ Format: show prp global

40.2.2 show prp instance

Show PRP instances.

- ▶ Mode: Command is in all modes available.
- ▶ Privilege Level: Guest
- ▶ Format: show prp instance [<P-1>]

| Parameter | Value | Meaning |
|-----------|-------|---|
| P-1 | 1..1 | Enter PRP instance number (only 1 supported). |

40.2.3 show prp node-table

Show node table (received supervision packets).

- ▶ Mode: Command is in all modes available.
- ▶ Privilege Level: Guest
- ▶ Format: show prp node-table [<P-1>]

| Parameter | Value | Meaning |
|-----------|-------|---|
| P-1 | 1..1 | Enter PRP instance number (only 1 supported). |

40.2.4 show prp proxy-node-table

Show proxy node table.

- ▶ Mode: Command is in all modes available.
- ▶ Privilege Level: Guest
- ▶ Format: show prp proxy-node-table [<P-1>]

| Parameter | Value | Meaning |
|-----------|-------|---|
| P-1 | 1..1 | Enter PRP instance number (only 1 supported). |

40.2.5 show prp counters

Show PRP counters.

- ▶ Mode: Command is in all modes available.
- ▶ Privilege Level: Guest
- ▶ Format: show prp counters [<P-1>]

| Parameter | Value | Meaning |
|-----------|-------|---|
| P-1 | 1..1 | Enter PRP instance number (only 1 supported). |

40.3 clear

Clear several items.

40.3.1 clear prp proxy-node-table

Clear proxy-node-table.

- ▶ Mode: Privileged Exec Mode
- ▶ Privilege Level: Operator
- ▶ Format: clear prp proxy-node-table [<P-1>]

| Paramete Value | Meaning |
|----------------|---|
| P-1 1..1 | Enter PRP instance number (only 1 supported). |

40.3.2 clear prp node-table

Clear node-table (received supervision packets).

- ▶ Mode: Privileged Exec Mode
- ▶ Privilege Level: Operator
- ▶ Format: clear prp node-table [<P-1>]

| Paramete Value | Meaning |
|----------------|---|
| P-1 1..1 | Enter PRP instance number (only 1 supported). |

40.3.3 clear prp counters

Clear PRP counters.

- ▶ Mode: Privileged Exec Mode
- ▶ Privilege Level: Operator
- ▶ Format: clear prp counters [<P-1>]

| Paramete Value | Meaning |
|----------------|---|
| P-1 1..1 | Enter PRP instance number (only 1 supported). |

41 MAC Notification

41.1 mac

Set MAC parameters.

41.1.1 mac notification operation

Enable or disable MAC notification globally.

- ▶ Mode: Global Config Mode
- ▶ Privilege Level: Operator
- ▶ Format: mac notification operation

■ no mac notification operation

Disable the option

- ▶ Mode: Global Config Mode
- ▶ Privilege Level: Operator
- ▶ Format: no mac notification operation

41.1.2 mac notification interval

Set MAC notification interval in seconds.

- ▶ Mode: Global Config Mode
- ▶ Privilege Level: Operator
- ▶ Format: mac notification interval <P-1>

| Parameter | Value | Meaning |
|-----------|---------------|------------------------------------|
| P-1 | 0..2147483647 | Enter a number in the given range. |

41.2 mac

MAC interface commands.

41.2.1 mac notification operation

Enable or disable MAC notification on this interface.

- ▶ **Mode:** Interface Range Mode
- ▶ **Privilege Level:** Operator
- ▶ **Format:** mac notification operation

■ **no mac notification operation**

Disable the option

- ▶ **Mode:** Interface Range Mode
- ▶ **Privilege Level:** Operator
- ▶ **Format:** no mac notification operation

41.3 show

Display device options and settings.

41.3.1 show mac notification global

Displays MAC notification global information.

- ▶ **Mode:** Command is in all modes available.
- ▶ **Privilege Level:** Guest
- ▶ **Format:** show mac notification global

41.3.2 show mac notification interface

Displays MAC notification interface information.

- ▶ **Mode:** Command is in all modes available.
- ▶ **Privilege Level:** Guest
- ▶ **Format:** show mac notification interface

42 Management Access

42.1 network

Configure the inband and outband connectivity.

42.1.1 network management access web timeout

Set the web interface idle timeout.

- ▶ **Mode:** Privileged Exec Mode
- ▶ **Privilege Level:** Administrator
- ▶ **Format:** network management access web timeout <P-1>

| Parameter | Value | Meaning |
|-----------|--------|--|
| P-1 | 0..160 | Idle timeout of a session in minutes (default: 5). |

42.1.2 network management access add

Add a new entry with index.

- ▶ **Mode:** Privileged Exec Mode
- ▶ **Privilege Level:** Administrator
- ▶ **Format:** network management access add <P-1> [ip <P-2>] [mask <P-3>] [http <P-4>] [https <P-5>] [snmp <P-6>] [telnet <P-7>] [iec61850-mms <P-8>] [modbus-tcp <P-9>] [ssh <P-10>] [ethernet-ip <P-11>] [profinet-io <P-12>]

[ip]: Configure IP address which should have access to management.

[mask]: Configure network mask to allow a subnet for management access.

[http]: Configure if HTTP is allowed to have management access.

[https]: Configure if HTTPS is allowed to have management access.

[snmp]: Configure if SNMP is allowed to have management access.

[telnet]: Configure if TELNET is allowed to have management access.

[iec61850-mms]: Configure if IEC61850-MMS is allowed to have management access.

[modbus-tcp]: Configure if Modbus TCP/IP is allowed to have management access.

[ssh]: Configure if SSH is allowed to have management access.

[ethernet-ip]: Configure if EtherNet/IP is allowed to have management access.

[profinet-io]: Configure if PROFINET is allowed to have management access.

| Parameter | Value | Meaning |
|-----------|---------|------------------------|
| P-1 | 1..16 | Pool entry index. |
| P-2 | a.b.c.d | IP address. |
| P-3 | 0..32 | Prefix length netmask. |
| P-4 | enable | Enable the option. |
| | disable | Disable the option. |

| Parameter | Value | Meaning |
|-----------|---------|---------------------|
| P-5 | enable | Enable the option. |
| | disable | Disable the option. |
| P-6 | enable | Enable the option. |
| | disable | Disable the option. |
| P-7 | enable | Enable the option. |
| | disable | Disable the option. |
| P-8 | enable | Enable the option. |
| | disable | Disable the option. |
| P-9 | enable | Enable the option. |
| | disable | Disable the option. |
| P-10 | enable | Enable the option. |
| | disable | Disable the option. |
| P-11 | enable | Enable the option. |
| | disable | Disable the option. |
| P-12 | enable | Enable the option. |
| | disable | Disable the option. |

42.1.3 network management access delete

Delete an entry with index.

- ▶ Mode: Privileged Exec Mode
- ▶ Privilege Level: Administrator
- ▶ Format: network management access delete <P-1>

| Parameter | Value | Meaning |
|-----------|-------|-------------------|
| P-1 | 1..16 | Pool entry index. |

42.1.4 network management access modify

Modify an entry with index.

- ▶ Mode: Privileged Exec Mode
- ▶ Privilege Level: Administrator
- ▶ Format: network management access modify <P-1> ip <P-2> mask <P-3> http <P-4> https <P-5> snmp <P-6> telnet <P-7> iec61850-mms <P-8> modbus-tcp <P-9> ssh <P-10> ethernet-ip <P-11> profinet-io <P-12>

ip: Configure ip-address which should have access to management.

mask: Configure network mask to allow a subnet for management access.

http: Configure if HTTP is allowed to have management access.

https: Configure if HTTPS is allowed to have management access.

snmp: Configure if SNMP is allowed to have management access.

telnet: Configure if TELNET is allowed to have management access.

`iec61850-mms`: Configure if IEC61850-MMS is allowed to have management access.

`modbus-tcp`: Configure if Modbus TCP/IP is allowed to have management access.

`ssh`: Configure if SSH is allowed to have management access.

`ethernet-ip`: Configure if EtherNet/IP is allowed to have management access.

`profinet-io`: Configure if PROFINET is allowed to have management access.

| Parameter | Value | Meaning |
|-----------|---------|------------------------|
| P-1 | 1..16 | Pool entry index. |
| P-2 | a.b.c.d | IP address. |
| P-3 | 0..32 | Prefix length netmask. |
| P-4 | enable | Enable the option. |
| | disable | Disable the option. |
| P-5 | enable | Enable the option. |
| | disable | Disable the option. |
| P-6 | enable | Enable the option. |
| | disable | Disable the option. |
| P-7 | enable | Enable the option. |
| | disable | Disable the option. |
| P-8 | enable | Enable the option. |
| | disable | Disable the option. |
| P-9 | enable | Enable the option. |
| | disable | Disable the option. |
| P-10 | enable | Enable the option. |
| | disable | Disable the option. |
| P-11 | enable | Enable the option. |
| | disable | Disable the option. |
| P-12 | enable | Enable the option. |
| | disable | Disable the option. |

42.1.5 network management access operation

Enable/Disable operation for RMA.

- ▶ Mode: Privileged Exec Mode
- ▶ Privilege Level: Administrator
- ▶ Format: network management access operation

■ no network management access operation

Disable the option

- ▶ Mode: Privileged Exec Mode
- ▶ Privilege Level: Administrator
- ▶ Format: no network management access operation

42.1.6 network management access status

Activate/Deactivate an entry.

- ▶ Mode: Privileged Exec Mode
- ▶ Privilege Level: Administrator
- ▶ Format: network management access status <P-1>

| Parameter | Value | Meaning |
|-----------|-------|-------------------|
| P-1 | 1..16 | Pool entry index. |

■ no network management access status

Disable the option

- ▶ Mode: Privileged Exec Mode
- ▶ Privilege Level: Administrator
- ▶ Format: no network management access status <P-1>

42.2 show

Display device options and settings.

42.2.1 show network management access global

Show global restricted management access preferences.

- ▶ **Mode:** Command is in all modes available.
- ▶ **Privilege Level:** Guest
- ▶ **Format:** show network management access global

42.2.2 show network management access rules

Show restricted management access rules.

- ▶ **Mode:** Command is in all modes available.
- ▶ **Privilege Level:** Guest
- ▶ **Format:** show network management access rules [<P-1>]

| Parameter | Value | Meaning |
|-----------|-------|-------------------|
| P-1 | 1..16 | Pool entry index. |

43 Modbus

43.1 modbus-tcp

Configure Modbus TCP/IP server settings.

43.1.1 modbus-tcp operation

Enable or disable the Modbus TCP/IP server.

- ▶ Mode: Global Config Mode
- ▶ Privilege Level: Operator
- ▶ Format: modbus-tcp operation

■ no modbus-tcp operation

Disable the option

- ▶ Mode: Global Config Mode
- ▶ Privilege Level: Operator
- ▶ Format: no modbus-tcp operation

43.1.2 modbus-tcp write-access

Enable or disable the write-access on Modbus TCP/IP registers. - Possible security risk, as Modbus TCP/IP communication is not authenticated - .

- ▶ Mode: Global Config Mode
- ▶ Privilege Level: Operator
- ▶ Format: modbus-tcp write-access

■ no modbus-tcp write-access

Disable the option

- ▶ Mode: Global Config Mode
- ▶ Privilege Level: Operator
- ▶ Format: no modbus-tcp write-access

43.1.3 modbus-tcp port

Defines the port number of the Modbus TCP/IP server (default: 502).

- ▶ Mode: Global Config Mode
- ▶ Privilege Level: Operator
- ▶ Format: modbus-tcp port <P-1>

| Parameter | Value | Meaning |
|-----------|----------|---------------------------------------|
| P-1 | 1..65535 | Enter port number between 1 and 65535 |

43.1.4 modbus-tcp max-sessions

Defines the maximum number of concurrent Modbus TCP/IP sessions (default: 5).

- ▶ Mode: Global Config Mode
- ▶ Privilege Level: Operator
- ▶ Format: modbus-tcp max-sessions <P-1>

| Parameter | Value | Meaning |
|-----------|-------|--|
| P-1 | 1..5 | Maximum number of concurrent Modbus TCP/IP server sessions (default: 5). |

43.2 show

Display device options and settings.

43.2.1 show modbus-tcp

Show the Modbus TCP/IP server settings.

- ▶ **Mode:** Command is in all modes available.
- ▶ **Privilege Level:** Guest
- ▶ **Format:** show modbus-tcp

44 Media Redundancy Protocol (MRP)

44.1 mrp

Configure the MRP settings.

44.1.1 mrp domain modify advanced-mode

Configure the MRM Advanced Mode.

- ▶ Mode: Global Config Mode
- ▶ Privilege Level: Operator
- ▶ Format: mrp domain modify advanced-mode <P-1>

| Parameter | Value | Meaning |
|-----------|---------|---------------------|
| P-1 | enable | Enable the option. |
| | disable | Disable the option. |

44.1.2 mrp domain modify manager-priority

Configure the MRM priority.

- ▶ Mode: Global Config Mode
- ▶ Privilege Level: Operator
- ▶ Format: mrp domain modify manager-priority <P-1>

| Parameter | Value | Meaning |
|-----------|----------|--|
| P-1 | 0..65535 | Enter the MRM priority (default: 32768). |

44.1.3 mrp domain modify mode

Configure the role of the MRP device.

- ▶ Mode: Global Config Mode
- ▶ Privilege Level: Operator
- ▶ Format: mrp domain modify mode <P-1>

| Parameter | Value | Meaning |
|-----------|---------|---|
| P-1 | client | The device will be in the role of a ring client (MRC). |
| | manager | The device will be in the role of a ring manager (MRM). |

44.1.4 mrp domain modify name

Configure the logical name of the MRP domain.

- ▶ Mode: Global Config Mode
- ▶ Privilege Level: Operator
- ▶ Format: mrp domain modify name <P-1>

| Parameter | Value | Meaning |
|-----------|--------|---|
| P-1 | string | Enter a user-defined text, max. 255 characters. |

44.1.5 mrp domain modify operation

Enable or disable the MRP function.

- ▶ Mode: Global Config Mode
- ▶ Privilege Level: Operator
- ▶ Format: mrp domain modify operation <P-1>

| Parameter | Value | Meaning |
|-----------|---------|---------------------|
| P-1 | enable | Enable the option. |
| | disable | Disable the option. |

44.1.6 mrp domain modify port primary

Configure the primary ringport.

- ▶ Mode: Global Config Mode
- ▶ Privilege Level: Operator
- ▶ Format: mrp domain modify port primary <P-1>

| Parameter | Value | Meaning |
|-----------|-------------------|---------|
| P-1 | slot no./port no. | |

44.1.7 mrp domain modify port secondary

Configure the secondary ringport.

- ▶ Mode: Global Config Mode
- ▶ Privilege Level: Operator
- ▶ Format: `mrp domain modify port secondary <P-1> [fixed-backup <P-2>]`
[fixed-backup]: Enable or disable the secondary ringport of the manager to be the backup port permanently.

| Paramete r | Value | Meaning |
|---------------|-------------------|---------------------|
| P-1 | slot no./port no. | |
| P-2 | enable | Enable the option. |
| | disable | Disable the option. |

44.1.8 mrp domain modify recovery-delay

Configure the MRM Recovery Delay.

- ▶ Mode: Global Config Mode
- ▶ Privilege Level: Operator
- ▶ Format: `mrp domain modify recovery-delay <P-1>`

| Paramete r | Value | Meaning |
|---------------|-------|--|
| P-1 | 500ms | Maximum recovery delay of 500ms in the MRP domain. |
| | 200ms | Maximum recovery delay of 200ms in the MRP domain. |
| | 30ms | Maximum recovery delay of 30ms in the MRP domain. |
| | 10ms | Maximum recovery delay of 10ms in the MRP domain. |

44.1.9 mrp domain modify round-trip-delay

Configure the round-trip-delay counters.

- ▶ Mode: Global Config Mode
- ▶ Privilege Level: Operator
- ▶ Format: `mrp domain modify round-trip-delay <P-1>`

| Paramete r | Value | Meaning |
|---------------|-------|--------------------------------------|
| P-1 | reset | Reset the round-trip-delay counters. |

44.1.10 mrp domain modify vlan

Configure the VLAN identifier of the MRP domain.\n(VLAN ID 0 means that no VLAN is used).

- ▶ Mode: Global Config Mode
- ▶ Privilege Level: Operator
- ▶ Format: mrp domain modify vlan <P-1>

| Parameter | Value | Meaning |
|-----------|---------|---|
| P-1 | 0..4042 | VLAN identifier of the MRP domain.\n(VLAN ID 0 means that no VLAN is used). |

44.1.11 mrp domain add default-domain

Default MRP domain ID.

- ▶ Mode: Global Config Mode
- ▶ Privilege Level: Operator
- ▶ Format: mrp domain add default-domain

44.1.12 mrp domain add domain-id

MRP domain ID. Format: 16 bytes in decimal notation.\n(Example: 1.2.3.4.5.6.7.8.9.10.11.12.13.14.15.16).

- ▶ Mode: Global Config Mode
- ▶ Privilege Level: Operator
- ▶ Format: mrp domain add domain-id <P-1>

| Parameter | Value | Meaning |
|-----------|--------|--|
| P-1 | string | <domain id> MRP domain ID. Format: 16 bytes in decimal notation.\n(Example: 1.2.3.4.5.6.7.8.9.10.11.12.13.14.15.16). |

44.1.13 mrp domain delete

Delete the current MRP domain.

- ▶ Mode: Global Config Mode
- ▶ Privilege Level: Operator
- ▶ Format: mrp domain delete

44.1.14 mrp operation

Enable or disable MRP.

- ▶ **Mode:** Global Config Mode
- ▶ **Privilege Level:** Operator
- ▶ **Format:** mrp operation

■ **no mrp operation**

Disable the option

- ▶ **Mode:** Global Config Mode
- ▶ **Privilege Level:** Operator
- ▶ **Format:** no mrp operation

44.2 show

Display device options and settings.

44.2.1 show mrp

Show MRP settings.

- ▶ **Mode:** Command is in all modes available.
- ▶ **Privilege Level:** Guest
- ▶ **Format:** show mrp

45 MRP IEEE

45.1 mrp-ieee

Configure IEEE MRP parameters and protocols, MVRP for dynamic VLAN registration and MMRP for dynamic MAC registration on a port.

45.1.1 mrp-ieee global join-time

Set the IEEE multiple registration protocol join time-interval. The join timer controls the interval between join message transmissions sent to applicant state machines. An instance of this timer is required on a per-Port, per-MRP participant basis.

- ▶ Mode: Interface Range Mode
- ▶ Privilege Level: Operator
- ▶ Format: `mrp-ieee global join-time <P-1>`

| Parameter | Value | Meaning |
|-----------|---------|--------------------------------------|
| P-1 | 10..100 | Join time-interval in centi-seconds. |

45.1.2 mrp-ieee global leave-time

Set the IEEE multiple registration protocol leave time-interval. The leave timer controls the period of time that the registrar state machine waits in the leave state before transiting to the empty state. An instance of the timer is required for each state machine in the leave state.

- ▶ Mode: Interface Range Mode
- ▶ Privilege Level: Operator
- ▶ Format: `mrp-ieee global leave-time <P-1>`

| Parameter | Value | Meaning |
|-----------|---------|---------------------------------------|
| P-1 | 20..600 | Leave time-interval in centi-seconds. |

45.1.3 mrp-ieee global leave-all-time

Set the IEEE multiple registration protocol leave-all time-interval. The leave all timer controls the frequency with which the leaveall state machine generates leaveall PDUs. The timer is required on a per-Port, per-MRP Participant basis.

- ▶ Mode: Interface Range Mode
- ▶ Privilege Level: Operator
- ▶ Format: mrp-ieee global leave-all-time <P-1>

| Parameter | Value | Meaning |
|-----------|-----------|---|
| P-1 | 200..6000 | Leave-All time-interval in centi-seconds. |

45.2 show

Display device options and settings.

45.2.1 show mrp-ieee global interface

Show the global configuration of IEEE multiple registration protocol per interface.

- ▶ **Mode:** Command is in all modes available.
- ▶ **Privilege Level:** Guest
- ▶ **Format:** show mrp-ieee global interface [<P-1>]

| Parameter | Value | Meaning |
|-----------|-------------------|---------|
| P-1 | slot no./port no. | |

46 MRP IEEE MMRP

46.1 mrp-ieee

Configure IEEE MRP protocols.

46.1.1 mrp-ieee mmrp vlan-id

Configure the VLAN parameters.

- ▶ **Mode:** VLAN Database Mode
- ▶ **Privilege Level:** Operator
- ▶ **Format:** mrp-ieee mmrp vlan-id <P-1> forward-all <P-2> forbidden-servicereq <P-3>

forward-all: Enable or disable 'Forward All Groups' in a given Vlan for a given interface.

forbidden-servicereq: Enable or disable the mmrp feature 'Forbidden Service Requirement' in a given Vlan for a given interface.

| Parameter | Value | Meaning |
|-----------|-------------------|--------------------|
| P-1 | 1..4042 | Enter the VLAN ID. |
| P-2 | slot no./port no. | |
| P-3 | slot no./port no. | |

■ no mrp-ieee mmrp vlan-id

Disable the option

- ▶ **Mode:** VLAN Database Mode
- ▶ **Privilege Level:** Operator
- ▶ **Format:** no mrp-ieee mmrp vlan-id <P-1> forward-all <P-2> forbidden-servicereq <P-3>

46.2 show

Display device options and settings.

46.2.1 show mrp-ieee mmrp global

Display the IEEE MMRP global configuration.

- ▶ **Mode:** Command is in all modes available.
- ▶ **Privilege Level:** Guest
- ▶ **Format:** show mrp-ieee mmrp global

46.2.2 show mrp-ieee mmrp interface

Display the IEEE MMRP interface configuration.

- ▶ **Mode:** Command is in all modes available.
- ▶ **Privilege Level:** Guest
- ▶ **Format:** show mrp-ieee mmrp interface [<P-1>]

| Parameter | Value | Meaning |
|-----------|-------------------|---------|
| P-1 | slot no./port no. | |

46.2.3 show mrp-ieee mmrp statistics global

Display the IEEE MMRP global statistics.

- ▶ **Mode:** Command is in all modes available.
- ▶ **Privilege Level:** Guest
- ▶ **Format:** show mrp-ieee mmrp statistics global

46.2.4 show mrp-ieee mmrp statistics interface

Display the IEEE MMRP interface statistics.

- ▶ Mode: Command is in all modes available.
- ▶ Privilege Level: Guest
- ▶ Format: show mrp-ieee mmrp statistics interface [<P-1>]

| Parameter | Value | Meaning |
|-----------|-------------------|---------|
| P-1 | slot no./port no. | |

46.2.5 show mrp-ieee mmrp service-requirement forward-all vlan

Show Forward-All setting for port in given VLAN.

- ▶ Mode: Command is in all modes available.
- ▶ Privilege Level: Guest
- ▶ Format: show mrp-ieee mmrp service-requirement forward-all vlan [<P-1>]

| Parameter | Value | Meaning |
|-----------|---------|--------------------|
| P-1 | 1..4042 | Enter the VLAN ID. |

46.2.6 show mrp-ieee mmrp service-requirement forbidden vlan

Show Forward-All setting for port in given VLAN.

- ▶ Mode: Command is in all modes available.
- ▶ Privilege Level: Guest
- ▶ Format: show mrp-ieee mmrp service-requirement forbidden vlan [<P-1>]

| Parameter | Value | Meaning |
|-----------|---------|--------------------|
| P-1 | 1..4042 | Enter the VLAN ID. |

46.3 mrp-ieee

Configure IEEE MRP protocols, MVRP for dynamic VLAN registration and MMRP for dynamic MAC registration.

46.3.1 mrp-ieee mmrp operation

Enable or disable MMRP globally. Devices use MMRP information for dynamic registration of group membership and individual MAC addresses with end devices and switches that support extended filtering services, within the connected LAN.

- ▶ Mode: Global Config Mode
- ▶ Privilege Level: Operator
- ▶ Format: mrp-ieee mmrp operation

■ no mrp-ieee mmrp operation

Disable the option

- ▶ Mode: Global Config Mode
- ▶ Privilege Level: Operator
- ▶ Format: no mrp-ieee mmrp operation

46.3.2 mrp-ieee mmrp periodic-machine

Enable or disable MMRP periodic state machine globally. When enabled, the periodic state machine sends extra MMRP messages when the periodic timer expires.

- ▶ Mode: Global Config Mode
- ▶ Privilege Level: Operator
- ▶ Format: mrp-ieee mmrp periodic-machine

■ no mrp-ieee mmrp periodic-machine

Disable the option

- ▶ Mode: Global Config Mode
- ▶ Privilege Level: Operator
- ▶ Format: no mrp-ieee mmrp periodic-machine

46.4 clear

Clear several items.

46.4.1 clear mrp-ieee mmrp

Clear the IEEE MMRP global and port statistic tables.

- ▶ Mode: Privileged Exec Mode
- ▶ Privilege Level: Operator
- ▶ Format: `clear mrp-ieee mmrp`

46.5 mrp-ieee

Configure IEEE MRP parameters and protocols, MVRP for dynamic VLAN registration and MMRP for dynamic MAC registration on a port.

46.5.1 mrp-ieee mmrp operation

Enable or disable MMRP on the interface, with MMRP enabled globally and on this interface, the device sends and receives MMRP messages on this port.

- ▶ Mode: Interface Range Mode
- ▶ Privilege Level: Operator
- ▶ Format: mrp-ieee mmrp operation

■ no mrp-ieee mmrp operation

Disable the option

- ▶ Mode: Interface Range Mode
- ▶ Privilege Level: Operator
- ▶ Format: no mrp-ieee mmrp operation

46.5.2 mrp-ieee mmrp restrict-register

Enable or disable restriction of dynamic mac address registration using IEEE MMRP on the port. When enabled, the dynamic registration of mac address attributes is allowed only if the attribute has already been statically registered on the device.

- ▶ Mode: Interface Range Mode
- ▶ Privilege Level: Operator
- ▶ Format: mrp-ieee mmrp restrict-register

■ no mrp-ieee mmrp restrict-register

Disable the option

- ▶ Mode: Interface Range Mode
- ▶ Privilege Level: Operator
- ▶ Format: no mrp-ieee mmrp restrict-register

46.6 show

Display device options and settings.

46.6.1 show mac-filter-table mmrp

Display MMRP entries in the MFDB table.

- ▶ **Mode:** Command is in all modes available.
- ▶ **Privilege Level:** Guest
- ▶ **Format:** show mac-filter-table mmrp

47 MRP IEEE MVRP

47.1 mrp-ieee

Configure IEEE MRP protocols, MVRP for dynamic VLAN registration and MMRP for dynamic MAC registration.

47.1.1 mrp-ieee mvrp operation

Enable or disable IEEE MVRP globally. When enabled, the device distributes VLAN membership information on MVRP enable active ports. MVRP-aware devices use the information to dynamically create VLAN members and update the local VLAN member database.

- ▶ Mode: Global Config Mode
- ▶ Privilege Level: Operator
- ▶ Format: mrp-ieee mvrp operation

■ no mrp-ieee mvrp operation

Disable the option

- ▶ Mode: Global Config Mode
- ▶ Privilege Level: Operator
- ▶ Format: no mrp-ieee mvrp operation

47.1.2 mrp-ieee mvrp periodic-machine

Enable or disable IEEE MVRP periodic state machine globally. When enabled, the device sends MVRP messages to the connected MVRP-aware devices when the periodic timer expires.

- ▶ Mode: Global Config Mode
- ▶ Privilege Level: Operator
- ▶ Format: mrp-ieee mvrp periodic-machine

■ no mrp-ieee mvrp periodic-machine

Disable the option

- ▶ Mode: Global Config Mode
- ▶ Privilege Level: Operator
- ▶ Format: no mrp-ieee mvrp periodic-machine

47.2 mrp-ieee

Configure IEEE MRP parameters and protocols, MVRP for dynamic VLAN registration and MMRP for dynamic MAC registration on a port.

47.2.1 mrp-ieee mvrp operation

Enable or disable IEEE MVRP on the port. When enabled, globally and on this port, the device distributes VLAN membership information to MVRP aware devices connected to this port.

- ▶ Mode: Interface Range Mode
- ▶ Privilege Level: Operator
- ▶ Format: mrp-ieee mvrp operation

■ no mrp-ieee mvrp operation

Disable the option

- ▶ Mode: Interface Range Mode
- ▶ Privilege Level: Operator
- ▶ Format: no mrp-ieee mvrp operation

47.2.2 mrp-ieee mvrp restrict-register

Enable or disable restriction of dynamic VLAN registration using IEEE MVRP on the port. When enabled, the dynamic registration of VLAN attributes is allowed only if the attribute has already been statically registered on the device.

- ▶ Mode: Interface Range Mode
- ▶ Privilege Level: Operator
- ▶ Format: mrp-ieee mvrp restrict-register

■ no mrp-ieee mvrp restrict-register

Disable the option

- ▶ Mode: Interface Range Mode
- ▶ Privilege Level: Operator
- ▶ Format: no mrp-ieee mvrp restrict-register

47.3 show

Display device options and settings.

47.3.1 show mrp-ieee mvrp global

Display the IEEE MVRP global configuration.

- ▶ Mode: Command is in all modes available.
- ▶ Privilege Level: Guest
- ▶ Format: show mrp-ieee mvrp global

47.3.2 show mrp-ieee mvrp interface

Display the IEEE MVRP interface configuration.

- ▶ Mode: Command is in all modes available.
- ▶ Privilege Level: Guest
- ▶ Format: show mrp-ieee mvrp interface [<P-1>]

| Parameter | Value | Meaning |
|-----------|-------------------|---------|
| P-1 | slot no./port no. | |

47.3.3 show mrp-ieee mvrp statistics global

Display the IEEE MVRP global statistics.

- ▶ Mode: Command is in all modes available.
- ▶ Privilege Level: Guest
- ▶ Format: show mrp-ieee mvrp statistics global

47.3.4 show mrp-ieee mvrp statistics interface

Display the IEEE MVRP interface statistics.

- ▶ **Mode:** Command is in all modes available.
- ▶ **Privilege Level:** Guest
- ▶ **Format:** show mrp-ieee mvrp statistics interface [<P-1>]

| Parameter | Value | Meaning |
|-----------|-------------------|---------|
| P-1 | slot no./port no. | |

47.4 clear

Clear several items.

47.4.1 clear mrp-ieee mvrp

Clear the IEEE MVRP global and port statistic tables.

- ▶ Mode: Privileged Exec Mode
- ▶ Privilege Level: Operator
- ▶ Format: `clear mrp-ieee mvrp`

48 Out-of-band Management

48.1 network

Configure the inband and outband connectivity.

48.1.1 network out-of-band operation

Enable or disable the out-of-band management.

- ▶ Mode: Privileged Exec Mode
- ▶ Privilege Level: Operator
- ▶ Format: network out-of-band operation

■ no network out-of-band operation

Disable the option

- ▶ Mode: Privileged Exec Mode
- ▶ Privilege Level: Operator
- ▶ Format: no network out-of-band operation

48.1.2 network out-of-band protocol

Select DHCP or none as the out-of-band configuration protocol.

- ▶ Mode: Privileged Exec Mode
- ▶ Privilege Level: Operator
- ▶ Format: network out-of-band protocol <P-1>

| Parameter | Value | Meaning |
|-----------|-------|---------------------------------|
| P-1 | none | No out-of-band config protocol. |
| | dhcp | DHCP |

48.1.3 network out-of-band parms

Set out-of-band IP address, subnet mask and gateway.

- ▶ Mode: Privileged Exec Mode
- ▶ Privilege Level: Operator
- ▶ Format: network out-of-band parms <P-1> <P-2> [<P-3>]

| Parameter | Value | Meaning |
|-----------|---------|-------------|
| P-1 | A.B.C.D | IP address. |
| P-2 | A.B.C.D | IP address. |
| P-3 | A.B.C.D | IP address. |

48.2 show

Display device options and settings.

49 Protocol Based VLAN

49.1 vlan

Creation and configuration of VLANs.

49.1.1 vlan protocol group add

Add a new group or add protocols to an existing group.

▶ **Mode:** VLAN Database Mode

▶ **Privilege Level:** Operator

▶ **Format:** `vlan protocol group add <P-1> name <P-2> vlan-id <P-3> ethertype <P-4>`

`name`: Assign a group name .

`vlan-id`: Associate a VLAN ID to a group.

`ethertype`: Add protocols to an existing group. Before adding protocols to a group please create one.

| Parameter | Value | Meaning |
|-----------|---------|---|
| P-1 | 1..128 | Protocol based VLANs group index. |
| P-2 | string | Enter a user-defined text, max. 256 characters. |
| P-3 | 1..4042 | Enter the VLAN ID. |
| P-4 | string | <protocol-list> Enter a comma-separated list of mnemonics or values, max. 256 chars (eg.: 1536-65535, ip, arp, ipx). Hexadecimal values are entered with a leading '\0x\' , eg. 0x600-0xffff. |

■ no vlan protocol group add

Disable the option

▶ **Mode:** VLAN Database Mode

▶ **Privilege Level:** Operator

▶ **Format:** `no vlan protocol group add name vlan-id ethertype <P-4>`

49.1.2 vlan protocol group modify

Modify a protocol group.

▶ **Mode:** VLAN Database Mode

▶ **Privilege Level:** Operator

▶ **Format:** `vlan protocol group modify <P-1> [name <P-2>] [vlan-id <P-3>] [ethertype <P-4>]`

`[name]`: Modify the group name.

`[vlan-id]`: Modify the VLAN ID of a group.

[ethertype]: Modify ethertypes from a protocol group.

| Parameter | Value | Meaning |
|-----------|---------|---|
| P-1 | 1..128 | Protocol based VLANs group index. |
| P-2 | string | Enter a user-defined text, max. 256 characters. |
| P-3 | 1..4042 | Enter the VLAN ID. |
| P-4 | string | <protocol-list> Enter a comma-separated list of mnemonics or values, max. 256 chars (eg.: 1536-65535, ip, arp, ipx). Hexadecimal values are entered with a leading '\0x\'', eg. 0x600-0xffff. |

49.1.3 vlan protocol group delete

Delete a protocol group.

- ▶ Mode: VLAN Database Mode
- ▶ Privilege Level: Operator
- ▶ Format: vlan protocol group delete <P-1> [ethertype <P-2>]

[ethertype]: Remove ethertypes from a protocol group.

| Parameter | Value | Meaning |
|-----------|--------|---|
| P-1 | 1..128 | Protocol based VLANs group index. |
| P-2 | string | <protocol-list> Enter a comma-separated list of mnemonics or values, max. 256 chars (eg.: 1536-65535, ip, arp, ipx). Hexadecimal values are entered with a leading '\0x\'', eg. 0x600-0xffff. |

49.2 vlan

Configure 802.1Q port parameters for VLANs.

49.2.1 vlan protocol group add

Add this interface to a group.

- ▶ Mode: Interface Range Mode
- ▶ Privilege Level: Operator
- ▶ Format: vlan protocol group add <P-1>

| Parameter | Value | Meaning |
|-----------|--------|-----------------------------------|
| P-1 | 1..128 | Protocol based VLANs group index. |

49.2.2 vlan protocol group delete

Remove this interface from a group.

- ▶ Mode: Interface Range Mode
- ▶ Privilege Level: Operator
- ▶ Format: vlan protocol group delete <P-1>

| Parameter | Value | Meaning |
|-----------|--------|-----------------------------------|
| P-1 | 1..128 | Protocol based VLANs group index. |

49.3 show

Display device options and settings.

50 Port Monitor

50.1 port-monitor

Configure the Port Monitor condition settings.

50.1.1 port-monitor operation

Enable or disable the port monitor.

- ▶ Mode: Global Config Mode
- ▶ Privilege Level: Operator
- ▶ Format: port-monitor operation

■ no port-monitor operation

Disable the option

- ▶ Mode: Global Config Mode
- ▶ Privilege Level: Operator
- ▶ Format: no port-monitor operation

50.2 port-monitor

Configure the Port Monitor condition settings.

50.2.1 port-monitor condition crc-fragments interval

Configure the measure interval in seconds (5-180s) for CRC-Fragment detection. Default 10.

- ▶ Mode: Interface Range Mode
- ▶ Privilege Level: Operator
- ▶ Format: `port-monitor condition crc-fragments interval <P-1>`

| Parameter | Value | Meaning |
|-----------|--------|------------------------------------|
| P-1 | 5..180 | Enter a number in the given range. |

50.2.2 port-monitor condition crc-fragments count

Configure the CRC-Fragment counter in parts per million (1-1000000 [ppm]). Default 1000 [ppm].

- ▶ Mode: Interface Range Mode
- ▶ Privilege Level: Operator
- ▶ Format: `port-monitor condition crc-fragments count <P-1>`

| Parameter | Value | Meaning |
|-----------|------------|------------------------------------|
| P-1 | 1..1000000 | Enter a number in the given range. |

50.2.3 port-monitor condition crc-fragments mode

Enable or disable CRC-Fragments condition to trigger an action.

- ▶ Mode: Interface Range Mode
- ▶ Privilege Level: Operator
- ▶ Format: `port-monitor condition crc-fragments mode`

■ no port-monitor condition crc-fragments mode

Disable the option

- ▶ Mode: Interface Range Mode
- ▶ Privilege Level: Operator
- ▶ Format: no port-monitor condition crc-fragments mode

50.2.4 port-monitor condition link-flap interval

Configure the measure interval in seconds (1-180s) for Link Flap detection. Default 10.

- ▶ Mode: Interface Range Mode
- ▶ Privilege Level: Operator
- ▶ Format: port-monitor condition link-flap interval <P-1>

| Paramete Value | Meaning | |
|----------------|---------|------------------------------------|
| P-1 | 1..180 | Enter a number in the given range. |

50.2.5 port-monitor condition link-flap count

Configure the Link Flap counter (1-100). Default 5.

- ▶ Mode: Interface Range Mode
- ▶ Privilege Level: Operator
- ▶ Format: port-monitor condition link-flap count <P-1>

| Paramete Value | Meaning | |
|----------------|---------|------------------------------------|
| P-1 | 1..100 | Enter a number in the given range. |

50.2.6 port-monitor condition link-flap mode

Enable or disable link-flap condition to trigger an action.

- ▶ Mode: Interface Range Mode
- ▶ Privilege Level: Operator
- ▶ Format: port-monitor condition link-flap mode

■ no port-monitor condition link-flap mode

Disable the option

- ▶ Mode: Interface Range Mode
- ▶ Privilege Level: Operator
- ▶ Format: no port-monitor condition link-flap mode

50.2.7 port-monitor condition duplex-mismatch mode

Enable or disable duplex mismatch detection condition to trigger an action.

- ▶ Mode: Interface Range Mode
- ▶ Privilege Level: Operator
- ▶ Format: port-monitor condition duplex-mismatch mode

■ no port-monitor condition duplex-mismatch mode

Disable the option

- ▶ Mode: Interface Range Mode
- ▶ Privilege Level: Operator
- ▶ Format: no port-monitor condition duplex-mismatch mode

50.2.8 port-monitor condition overload-detection traffic-type

Configure Overload detection condition traffic type.

- ▶ Mode: Interface Range Mode
- ▶ Privilege Level: Operator
- ▶ Format: port-monitor condition overload-detection traffic-type <P-1>

| Parameter | Value | Meaning |
|-----------|-------|----------------------------------|
| P-1 | all | All packets. |
| | bc | Broadcast packets. |
| | bc-mc | Broadcast and multicast packets. |

50.2.9 port-monitor condition overload-detection unit

Configure Overload detection condition threshold type.

- ▶ Mode: Interface Range Mode
- ▶ Privilege Level: Operator
- ▶ Format: port-monitor condition overload-detection unit <P-1>

| Parameter | Value | Meaning |
|-----------|-------|----------------------|
| P-1 | pps | Packets per second. |
| | kbps | Kilobits per second. |

50.2.10 port-monitor condition overload-detection upper-threshold

Configure Overload detection condition threshold type upper-threshold.

- ▶ Mode: Interface Range Mode
- ▶ Privilege Level: Operator
- ▶ Format: port-monitor condition overload-detection upper-threshold <P-1>

| Parameter | Value | Meaning |
|-----------|-------------|------------------------------------|
| P-1 | 0..10000000 | Enter a number in the given range. |

50.2.11 port-monitor condition overload-detection lower-threshold

Configure Overload detection condition threshold type lower-threshold.

- ▶ Mode: Interface Range Mode
- ▶ Privilege Level: Operator
- ▶ Format: port-monitor condition overload-detection lower-threshold <P-1>

| Parameter | Value | Meaning |
|-----------|-------------|------------------------------------|
| P-1 | 0..10000000 | Enter a number in the given range. |

50.2.12 port-monitor condition overload-detection polling-interval

Configure Overload detection condition detection interval.

- ▶ Mode: Interface Range Mode
- ▶ Privilege Level: Operator
- ▶ Format: port-monitor condition overload-detection polling-interval <P-1>

| Parameter | Value | Meaning |
|-----------|-------|------------------------------------|
| P-1 | 1..20 | Enter a number in the given range. |

50.2.13 port-monitor condition overload-detection mode

Enable or disable Overload-Detection condition to trigger an action.

- ▶ Mode: Interface Range Mode
- ▶ Privilege Level: Operator
- ▶ Format: port-monitor condition overload-detection mode

■ no port-monitor condition overload-detection mode

Disable the option

- ▶ Mode: Interface Range Mode
- ▶ Privilege Level: Operator
- ▶ Format: no port-monitor condition overload-detection mode

50.2.14 port-monitor condition speed-duplex mode

Enable or disable link speed and duplex condition to trigger an action.

- ▶ Mode: Interface Range Mode
- ▶ Privilege Level: Operator
- ▶ Format: port-monitor condition speed-duplex mode

■ no port-monitor condition speed-duplex mode

Disable the option

- ▶ Mode: Interface Range Mode
- ▶ Privilege Level: Operator
- ▶ Format: no port-monitor condition speed-duplex mode

50.2.15 port-monitor condition speed-duplex speed

Set speed-duplex combination.

- ▶ Mode: Interface Range Mode
- ▶ Privilege Level: Operator
- ▶ Format: port-monitor condition speed-duplex speed [<P-1>] [<P-2>] [<P-3>] [<P-4>] [<P-5>] [<P-6>] [<P-7>]

| Parameter | Value | Meaning |
|-----------|------------|---------------------------|
| P-1 | [hdx10] | 10 Mbit/s - half duplex |
| P-2 | [fdx10] | 10 Mbit/s - full duplex |
| P-3 | [hdx100] | 100 Mbit/s - half duplex |
| P-4 | [fdx100] | 100 Mbit/s - full duplex |
| P-5 | [hdx-1000] | 1000 Mbit/s - half duplex |
| P-6 | [fdx-1000] | 1000 Mbit/s - full duplex |
| P-7 | [fdx-2500] | 2500 Mbit/s - full duplex |

50.2.16 port-monitor condition speed-duplex clear

Clear the allowed speed-duplex combination list.

- ▶ Mode: Interface Range Mode
- ▶ Privilege Level: Operator
- ▶ Format: port-monitor condition speed-duplex clear

50.2.17 port-monitor action

Enable or disable interface on port condition.

- ▶ Mode: Interface Range Mode
- ▶ Privilege Level: Operator
- ▶ Format: port-monitor action <P-1>

| Parameter | Value | Meaning |
|-----------|--------------|---|
| P-1 | port-disable | Disable interface on port condition. |
| | trap-only | Send only a trap. |
| | auto-disable | Enable or disable interface on port condition by AUTODIS. |

50.2.18 port-monitor reset

Reset the port monitor.

- ▶ **Mode:** Interface Range Mode
- ▶ **Privilege Level:** Operator
- ▶ **Format:** port-monitor reset [<P-1>]

| Parameter | Value | Meaning |
|-----------|-------|-------------------------------------|
| P-1 | port | Press Enter to execute the command. |

■ no port-monitor reset

Disable the option

- ▶ **Mode:** Interface Range Mode
- ▶ **Privilege Level:** Operator
- ▶ **Format:** no port-monitor reset [<P-1>]

50.3 show

Display device options and settings.

50.3.1 show port-monitor operation

Display the Port Monitor operation.

- ▶ **Mode:** Command is in all modes available.
- ▶ **Privilege Level:** Guest
- ▶ **Format:** show port-monitor operation

50.3.2 show port-monitor brief

Display the Port Monitor summary.

- ▶ **Mode:** Command is in all modes available.
- ▶ **Privilege Level:** Guest
- ▶ **Format:** show port-monitor brief

50.3.3 show port-monitor overload-detection counters

Display the overload-detection counters of last interval.

- ▶ **Mode:** Command is in all modes available.
- ▶ **Privilege Level:** Guest
- ▶ **Format:** show port-monitor overload-detection counters

50.3.4 show port-monitor overload-detection port

Display the Port Monitor overload detection interface details.

- ▶ Mode: Command is in all modes available.
- ▶ Privilege Level: Guest
- ▶ Format: show port-monitor overload-detection port [<P-1>]

| Parameter | Value | Meaning |
|-----------|-------------------|---------|
| P-1 | slot no./port no. | |

50.3.5 show port-monitor speed-duplex

Display the Port Monitor link speed and duplex interface settings.

- ▶ Mode: Command is in all modes available.
- ▶ Privilege Level: Guest
- ▶ Format: show port-monitor speed-duplex [<P-1>]

| Parameter | Value | Meaning |
|-----------|-------------------|---------|
| P-1 | slot no./port no. | |

50.3.6 show port-monitor port

Display the Port Monitor interface details.

- ▶ Mode: Command is in all modes available.
- ▶ Privilege Level: Guest
- ▶ Format: show port-monitor port <P-1>

| Parameter | Value | Meaning |
|-----------|-------------------|---------|
| P-1 | slot no./port no. | |

50.3.7 show port-monitor link-flap

Display the link-flaps counts for a specific interface.

- ▶ Mode: Command is in all modes available.
- ▶ Privilege Level: Guest
- ▶ Format: show port-monitor link-flap <P-1>

| Paramete | Value | Meaning |
|----------|-------------------|---------|
| r | | |
| P-1 | slot no./port no. | |

50.3.8 show port-monitor crc-fragments

Display CRC-Fragments counts for a specific interface.

- ▶ **Mode:** Command is in all modes available.
- ▶ **Privilege Level:** Guest
- ▶ **Format:** show port-monitor crc-fragments <P-1>

| Paramete | Value | Meaning |
|----------|-------------------|---------|
| r | | |
| P-1 | slot no./port no. | |

51 Port Security

51.1 port-security

Port MAC locking/security

51.1.1 port-security operation

Enable/Disable Port MAC locking/security

- ▶ Mode: Global Config Mode
- ▶ Privilege Level: Operator
- ▶ Format: port-security operation

■ no port-security operation

Disable the option

- ▶ Mode: Global Config Mode
- ▶ Privilege Level: Operator
- ▶ Format: no port-security operation

51.2 port-security

Port MAC locking/security

51.2.1 port-security operation

Enable/Disable Port MAC locking/security for the interface.

- ▶ Mode: Interface Range Mode
- ▶ Privilege Level: Operator
- ▶ Format: port-security operation

■ no port-security operation

Disable the option

- ▶ Mode: Interface Range Mode
- ▶ Privilege Level: Operator
- ▶ Format: no port-security operation

51.2.2 port-security max-dynamic

Set dynamic limit for the interface.

- ▶ Mode: Interface Range Mode
- ▶ Privilege Level: Operator
- ▶ Format: port-security max-dynamic <P-1>

| Parameter | Value | Meaning |
|-----------|--------|--|
| P-1 | 0..600 | maximum number of dynamically locked MAC addresses allowed |

51.2.3 port-security max-static

Set Static Limit for the interface.

- ▶ Mode: Interface Range Mode
- ▶ Privilege Level: Operator
- ▶ Format: port-security max-static <P-1>

| Parameter | Value | Meaning |
|-----------|-------|---|
| P-1 | 0..64 | maximum number of statically locked MAC addresses allowed |

51.2.4 port-security mac-address add

Add Static MAC address to the interface.

- ▶ Mode: Interface Range Mode
- ▶ Privilege Level: Operator
- ▶ Format: port-security mac-address add <P-1> <P-2>

| Parameter | Value | Meaning |
|-----------|-------------------|--------------|
| P-1 | aa:bb:cc:dd:ee:ff | MAC address. |
| P-2 | 1..4042 | VLAN ID |

51.2.5 port-security mac-address move

Make dynamic MAC addresses static for the interface.

- ▶ Mode: Interface Range Mode
- ▶ Privilege Level: Operator
- ▶ Format: port-security mac-address move

51.2.6 port-security mac-address delete

Remove Static MAC address from the interface.

- ▶ Mode: Interface Range Mode
- ▶ Privilege Level: Operator
- ▶ Format: port-security mac-address delete <P-1> <P-2>

| Parameter | Value | Meaning |
|-----------|-------------------|--------------|
| P-1 | aa:bb:cc:dd:ee:ff | MAC address. |
| P-2 | 1..4042 | VLAN ID |

51.2.7 port-security violation-traps

SNMP violation traps for the interface.

- ▶ **Mode:** Interface Range Mode
- ▶ **Privilege Level:** Operator
- ▶ **Format:** port-security violation-traps operation [frequency <P-1>]
operation: Enable/Disable SNMP violation traps for the interface.
[frequency]: The minimum seconds between two successive violation traps on this port.

| Parameter | Value | Meaning |
|-----------|---------|-----------------|
| P-1 | 0..3600 | time in seconds |

■ no port-security violation-traps

Disable the option

- ▶ **Mode:** Interface Range Mode
- ▶ **Privilege Level:** Operator
- ▶ **Format:** no port-security violation-traps operation [frequency]

51.3 show

Display device options and settings.

51.3.1 show port-security global

Port Security global status

- ▶ Mode: Command is in all modes available.
- ▶ Privilege Level: Guest
- ▶ Format: show port-security global

51.3.2 show port-security interface

Display port-security (port MAC locking) information for system.

- ▶ Mode: Command is in all modes available.
- ▶ Privilege Level: Guest
- ▶ Format: show port-security interface [<P-1>]

| Parameter | Value | Meaning |
|-----------|-------------------|---------|
| P-1 | slot no./port no. | |

51.3.3 show port-security dynamic

Display dynamically learned MAC addresses

- ▶ Mode: Command is in all modes available.
- ▶ Privilege Level: Guest
- ▶ Format: show port-security dynamic <P-1>

| Parameter | Value | Meaning |
|-----------|-------------------|---------|
| P-1 | slot no./port no. | |

51.3.4 show port-security static

Display statically locked MAC addresses

- ▶ Mode: Command is in all modes available.
- ▶ Privilege Level: Guest
- ▶ Format: show port-security static <P-1>

| Parameter | Value | Meaning |
|-----------|-------------------|---------|
| P-1 | slot no./port no. | |

51.3.5 show port-security violation

Display port security violation information.

- ▶ Mode: Command is in all modes available.
- ▶ Privilege Level: Guest
- ▶ Format: show port-security violation <P-1>

| Parameter | Value | Meaning |
|-----------|-------------------|---------|
| P-1 | slot no./port no. | |

52 Profinet IO

52.1 profinet

Configures the PROFINET functionality on this device.

52.1.1 profinet operation

Enables or disables the PROFINET functionality on this device.

- ▶ Mode: Global Config Mode
- ▶ Privilege Level: Operator
- ▶ Format: profinet operation

■ no profinet operation

Disable the option

- ▶ Mode: Global Config Mode
- ▶ Privilege Level: Operator
- ▶ Format: no profinet operation

52.1.2 profinet name-of-station

Sets the name of the station.

- ▶ Mode: Global Config Mode
- ▶ Privilege Level: Operator
- ▶ Format: profinet name-of-station <P-1>

| Parameter | Value | Meaning |
|-----------|--------|--|
| P-1 | string | Enter the name of the station, alphanumeric ascii string, max. 240 characters. |

52.2 profinet

Configures the PROFINET functionality on this device.

52.2.1 profinet dcp-mode

Sets the PROFINET DCP mode on an interface.

- ▶ Mode: Interface Range Mode
- ▶ Privilege Level: Operator
- ▶ Format: `profinet dcp-mode <P-1>`

| Parameter | Value | Meaning |
|-----------|---------|--|
| P-1 | none | Sets the PROFINET DCP mode on an interface to none (neither ingress or egress). The agent does not respond to frames received on this interface. The interface does not forward frames received on other interfaces. |
| | ingress | Sets the PROFINET DCP mode on an interface to ingress only. The agent responds to frames received on this interface. The interface does not forward frames received on other interfaces. |
| | egress | Sets the PROFINET DCP mode on an interface to egress only. The agent does not respond to frames received on this interface. The interface forwards frames received on other interfaces. |
| | both | Sets the PROFINET DCP mode on an interface to both (ingress and egress). The agent responds to frames received on this interface. The interface forwards frames received on other interfaces. |

52.3 copy

Copy different kinds of items.

52.3.1 copy gsdml-profinet system remote

Copy the GSDML file from the device to the file server

- ▶ Mode: Privileged Exec Mode
- ▶ Privilege Level: Operator
- ▶ Format: copy gsdml-profinet system remote <P-1>

| Parameter | Value | Meaning |
|-----------|--------|---|
| P-1 | string | Enter a user-defined text, max. 128 characters. |

52.3.2 copy gsdml-profinet system envm

Copy the GSDML file from the device to external non-volatile memory.

- ▶ Mode: Privileged Exec Mode
- ▶ Privilege Level: Operator
- ▶ Format: copy gsdml-profinet system envm

52.4 show

Display device options and settings.

52.4.1 show profinet global

Show the PROFINET global settings.

- ▶ Mode: Command is in all modes available.
- ▶ Privilege Level: Guest
- ▶ Format: show profinet global

52.4.2 show profinet port

Show the port-related PROFINET settings.

- ▶ Mode: Command is in all modes available.
- ▶ Privilege Level: Guest
- ▶ Format: show profinet port

53 Precision Time Protocol (PTP)

53.1 ptp

Enable or disable the Precision Time Protocol (IEEE 1588-2008).

53.1.1 ptp operation

Enable or disable the Precision Time Protocol (IEEE 1588-2008).

- ▶ Mode: Global Config Mode
- ▶ Privilege Level: Administrator
- ▶ Format: ptp operation

■ no ptp operation

Disable the option

- ▶ Mode: Global Config Mode
- ▶ Privilege Level: Administrator
- ▶ Format: no ptp operation

53.1.2 ptp clock-mode

Configure PTPv2 (IEEE1588-2008) clock mode. \nIf the clock mode is changed, PTP will be initialized.

- ▶ Mode: Global Config Mode
- ▶ Privilege Level: Administrator
- ▶ Format: ptp clock-mode <P-1>

| Parameter | Value | Meaning |
|-----------|----------------------|---------|
| P-1 | v2-boundary-clock | |
| | v2-transparent-clock | |

53.1.3 ptp sync-lower-bound

Configure the lower bound for the PTP clock synchronization status (unit: nanoseconds). If the absolute value of the offset to the master clock is smaller than the lower bound, the clock's status is set to synchronized (true).

- ▶ Mode: Global Config Mode
- ▶ Privilege Level: Administrator
- ▶ Format: ptp sync-lower-bound <P-1>

| Parameter | Value | Meaning |
|-----------|--------------|---------|
| P-1 | 1..999999999 | |

53.1.4 ptp sync-upper-bound

Configure the upper bound for the PTP clock synchronization status (unit: nanoseconds). If the absolute value of the offset to the master clock is bigger than the upper bound, the clock's status is set to unsynchronized (false).

- ▶ Mode: Global Config Mode
- ▶ Privilege Level: Administrator
- ▶ Format: ptp sync-upper-bound <P-1>

| Parameter | Value | Meaning |
|-----------|----------------|---------|
| P-1 | 31..1000000000 | |

53.1.5 ptp management

Enable or disable PTP management via PTP management messages.

- ▶ Mode: Global Config Mode
- ▶ Privilege Level: Administrator
- ▶ Format: ptp management

■ no ptp management

Disable the option

- ▶ Mode: Global Config Mode
- ▶ Privilege Level: Administrator
- ▶ Format: no ptp management

53.1.6 ptp v2-transparent-clock syntonization

Enable or disable the syntonization (frequency synchronization) of the transparent-clock.

- ▶ Mode: Global Config Mode
- ▶ Privilege Level: Administrator
- ▶ Format: ptp v2-transparent-clock syntonization

■ no ptp v2-transparent-clock syntonization

Disable the option

- ▶ Mode: Global Config Mode
- ▶ Privilege Level: Administrator
- ▶ Format: no ptp v2-transparent-clock syntonization

53.1.7 ptp v2-transparent-clock network-protocol

Configure the network-protocol of the transparent-clock.

- ▶ Mode: Global Config Mode
- ▶ Privilege Level: Administrator
- ▶ Format: ptp v2-transparent-clock network-protocol <P-1>

| Parameter | Value | Meaning |
|-----------|-----------------------|---------|
| P-1 | ieee802.3 udp-ipv4 | |

53.1.8 ptp v2-transparent-clock multi-domain

Enable or disable the transparent-clock to process only the primary-domain or all domain numbers.

- ▶ Mode: Global Config Mode
- ▶ Privilege Level: Administrator
- ▶ Format: ptp v2-transparent-clock multi-domain

■ no ptp v2-transparent-clock multi-domain

Disable the option

- ▶ Mode: Global Config Mode
- ▶ Privilege Level: Administrator
- ▶ Format: no ptp v2-transparent-clock multi-domain

53.1.9 ptp v2-transparent-clock sync-local-clock

Enable or disable synchronization of the local clock (also enables syntonization).

- ▶ Mode: Global Config Mode
- ▶ Privilege Level: Administrator
- ▶ Format: ptp v2-transparent-clock sync-local-clock

■ no ptp v2-transparent-clock sync-local-clock

Disable the option

- ▶ Mode: Global Config Mode
- ▶ Privilege Level: Administrator
- ▶ Format: no ptp v2-transparent-clock sync-local-clock

53.1.10 ptp v2-transparent-clock delay-mechanism

Configure the delay mechanism of the transparent-clock.

- ▶ Mode: Global Config Mode
- ▶ Privilege Level: Administrator
- ▶ Format: ptp v2-transparent-clock delay-mechanism <P-1>

| Parameter | Value | Meaning |
|-----------|---------------|---------|
| P-1 | e2e | |
| | p2p | |
| | e2e-optimized | |
| | disable | |

53.1.11 ptp v2-transparent-clock primary-domain

Configure the primary-domain (for syntonization) of the transparent-clock.

- ▶ Mode: Global Config Mode
- ▶ Privilege Level: Administrator
- ▶ Format: ptp v2-transparent-clock primary-domain <P-1>

| Parameter | Value | Meaning |
|-----------|--------|------------------------------------|
| P-1 | 0..255 | Enter a number in the given range. |

53.1.12 ptp v2-transparent-clock vlan

VLAN in which PTP packets are send. With a value of none all packets are send untagged.

- ▶ Mode: Global Config Mode
- ▶ Privilege Level: Administrator
- ▶ Format: ptp v2-transparent-clock vlan <P-1>

| Parameter | Value | Meaning |
|-----------|--------|--|
| P-1 | vlanId | Send ptp to vlanId Use 0 for priority only tagged frames |
| | none | Send all ptp packets untagged |

53.1.13 ptp v2-transparent-clock vlan-priority

VLAN priority of tagged ptp packets.

- ▶ Mode: Global Config Mode
- ▶ Privilege Level: Administrator
- ▶ Format: ptp v2-transparent-clock vlan-priority <P-1>

| Parameter | Value | Meaning |
|-----------|-------|---------|
| P-1 | 0..7 | |

53.1.14 ptp v2-boundary-clock domain

Configure the PTP domain number (0..255)

- ▶ Mode: Global Config Mode
- ▶ Privilege Level: Administrator
- ▶ Format: ptp v2-boundary-clock domain <P-1>

| Parameter | Value | Meaning |
|-----------|--------|------------------------------------|
| P-1 | 0..255 | Enter a number in the given range. |

53.1.15 ptp v2-boundary-clock priority1

Configure the priority1 value (0..255) for the BMCA

- ▶ Mode: Global Config Mode
- ▶ Privilege Level: Administrator
- ▶ Format: ptp v2-boundary-clock priority1 <P-1>

| Parameter | Value | Meaning |
|-----------|--------|------------------------------------|
| P-1 | 0..255 | Enter a number in the given range. |

53.1.16 ptp v2-boundary-clock priority2

Configure the priority2 value (0..255) for the BMCA

- ▶ Mode: Global Config Mode
- ▶ Privilege Level: Administrator
- ▶ Format: ptp v2-boundary-clock priority2 <P-1>

| Parameter | Value | Meaning |
|-----------|--------|------------------------------------|
| P-1 | 0..255 | Enter a number in the given range. |

53.1.17 ptp v2-boundary-clock utc-offset

Configure the current UTC offset (TAI - UTC) in seconds.

- ▶ Mode: Global Config Mode
- ▶ Privilege Level: Administrator
- ▶ Format: ptp v2-boundary-clock utc-offset <P-1>

| Parameter | Value | Meaning |
|-----------|---------------|---------|
| P-1 | -32768..32767 | |

53.1.18 ptp v2-boundary-clock utc-offset-valid

Configure the UTC offset valid flag

- ▶ Mode: Global Config Mode
- ▶ Privilege Level: Administrator
- ▶ Format: ptp v2-boundary-clock utc-offset-valid <P-1>

| Parameter | Value | Meaning |
|-----------|-------|---------|
| P-1 | true | True |
| | false | False |

■ **no ptp v2-boundary-clock utc-offset-valid**

Disable the option

- ▶ Mode: Global Config Mode
- ▶ Privilege Level: Administrator
- ▶ Format: no ptp v2-boundary-clock utc-offset-valid <P-1>

53.2 ptp

Enable or disable the Precision Time Protocol (IEEE 1588-2008) on a port.

53.2.1 ptp v2-transparent-clock operation

Enable or disable the sending and receiving / processing of PTP synchronization messages.

- ▶ Mode: Interface Range Mode
- ▶ Privilege Level: Administrator
- ▶ Format: ptp v2-transparent-clock operation

■ no ptp v2-transparent-clock operation

Disable the option

- ▶ Mode: Interface Range Mode
- ▶ Privilege Level: Administrator
- ▶ Format: no ptp v2-transparent-clock operation

53.2.2 ptp v2-transparent-clock asymmetry

Set the asymmetry of the link connected to this interface

- ▶ Mode: Interface Range Mode
- ▶ Privilege Level: Administrator
- ▶ Format: ptp v2-transparent-clock asymmetry <P-1>

| Parameter | Value | Meaning |
|-----------|-----------------------------------|---------|
| P-1 | - 2000000000..2000000000 00 | |

53.2.3 ptp v2-transparent-clock pdelay-interval

Configure the Peer Delay Interval in seconds {1|2|4|8|16|32}. \nThis interval is used if delay-mechanism is set to p2p

- ▶ Mode: Interface Range Mode
- ▶ Privilege Level: Administrator
- ▶ Format: ptp v2-transparent-clock pdelay-interval <P-1>

| Parameter | Value | Meaning |
|-----------|-------|---------|
| P-1 | 1 | |
| | 2 | |
| | 4 | |
| | 8 | |
| | 16 | |
| | 32 | |

53.2.4 ptp v2-boundary-clock operation

Enable or disable the sending and receiving/processing of PTP synchronization messages.

- ▶ Mode: Interface Range Mode
- ▶ Privilege Level: Administrator
- ▶ Format: ptp v2-boundary-clock operation

■ no ptp v2-boundary-clock operation

Disable the option

- ▶ Mode: Interface Range Mode
- ▶ Privilege Level: Administrator
- ▶ Format: no ptp v2-boundary-clock operation

53.2.5 ptp v2-boundary-clock pdelay-interval

Configure the Peer Delay Interval in seconds {1|2|4|8|16|32}. \nThis interval is used if delay-mechanism is set to p2p

- ▶ Mode: Interface Range Mode
- ▶ Privilege Level: Administrator
- ▶ Format: ptp v2-boundary-clock pdelay-interval <P-1>

| Parameter | Value | Meaning |
|-----------|-------|---------|
| P-1 | 1 | |
| | 2 | |
| | 4 | |
| | 8 | |
| | 16 | |
| | 32 | |

53.2.6 ptp v2-boundary-clock announce-interval

Configure the Announce Interval in seconds {1|2|4|8|16}.

- ▶ Mode: Interface Range Mode
- ▶ Privilege Level: Administrator
- ▶ Format: ptp v2-boundary-clock announce-interval <P-1>

| Parameter | Value | Meaning |
|-----------|-------|---------|
| P-1 | 1 | |
| | 2 | |
| | 4 | |
| | 8 | |
| | 16 | |

53.2.7 ptp v2-boundary-clock sync-interval

Configure the Sync Interval in seconds {0.25|0.5|1|2}.

- ▶ Mode: Interface Range Mode
- ▶ Privilege Level: Administrator
- ▶ Format: ptp v2-boundary-clock sync-interval <P-1>

| Parameter | Value | Meaning |
|-----------|-------|---------|
| P-1 | 0.25 | |
| | 0.5 | |
| | 1 | |
| | 2 | |

53.2.8 ptp v2-boundary-clock announce-timeout

Configure the Announce Receipt Timeout (2..10).

- ▶ Mode: Interface Range Mode
- ▶ Privilege Level: Administrator
- ▶ Format: ptp v2-boundary-clock announce-timeout <P-1>

| Parameter | Value | Meaning |
|-----------|-------|---------|
| P-1 | 2..10 | |

53.2.9 ptp v2-boundary-clock asymmetry

Set the asymmetry of the link connected to this interface

- ▶ Mode: Interface Range Mode
- ▶ Privilege Level: Administrator
- ▶ Format: ptp v2-boundary-clock asymmetry <P-1>

| Parameter | Value | Meaning |
|-----------|---------------------------------|---------|
| P-1 | - 2000000000..20000000 00 | |

53.2.10 ptp v2-boundary-clock v1-compatibility-mode

Set the PTPv1 Hardware compatibility mode {auto|on|off}.

- ▶ Mode: Interface Range Mode
- ▶ Privilege Level: Administrator
- ▶ Format: ptp v2-boundary-clock v1-compatibility-mode <P-1>

| Parameter | Value | Meaning |
|-----------|-------|---------|
| P-1 | on | |
| | off | |
| | auto | |

53.2.11 ptp v2-boundary-clock delay-mechanism

Configure the delay mechanism of the boundary-clock.

- ▶ Mode: Interface Range Mode
- ▶ Privilege Level: Administrator
- ▶ Format: ptp v2-boundary-clock delay-mechanism <P-1>

| Parameter | Value | Meaning |
|-----------|---------|---------|
| P-1 | e2e | |
| | p2p | |
| | disable | |

53.2.12 ptp v2-boundary-clock network-protocol

Configure the network-protocol

- ▶ Mode: Interface Range Mode
- ▶ Privilege Level: Administrator
- ▶ Format: ptp v2-boundary-clock network-protocol <P-1>

| Parameter | Value | Meaning |
|-----------|-----------|---------|
| P-1 | ieee802.3 | |
| | udp-ipv4 | |

53.2.13 ptp v2-boundary-clock vlan-priority

VLAN priority of tagged ptp packets.

- ▶ Mode: Interface Range Mode
- ▶ Privilege Level: Administrator
- ▶ Format: ptp v2-boundary-clock vlan-priority <P-1>

| Parameter | Value | Meaning |
|-----------|-------|---------|
| P-1 | 0..7 | |

53.2.14 ptp v2-boundary-clock vlan

VLAN in which PTP packets are send. With a value of none all packets are send untagged.

- ▶ Mode: Interface Range Mode
- ▶ Privilege Level: Administrator
- ▶ Format: ptp v2-boundary-clock vlan <P-1>

| Parameter | Value | Meaning |
|-----------|--------|--|
| P-1 | vlanId | Send ptp to vlanId Use 0 for priority only tagged frames |
| | none | Send all ptp packets untagged |

53.3 show

Display device options and settings.

53.3.1 show ptp

Show PTP parameters and status

- ▶ **Mode:** Command is in all modes available.
- ▶ **Privilege Level:** Guest
- ▶ **Format:** show ptp [global] [v2-boundary-clock] [v2-transparent-clock] [port] [v2-transparent-clock] [v2-boundary-clock]
[global]: Show PTP global status
[v2-boundary-clock]: Show PTP Boundary Clock status
[v2-transparent-clock]: Show PTP Transparent Clock status
[port]: Show PTP port values
[v2-transparent-clock]: Show the PTP Transparent Clock port values
[v2-boundary-clock]: Show the PTP Boundary Clock port values.

54 Password Management

54.1 passwords

Manage password policies and options.

54.1.1 passwords min-length

Set minimum password length for user passwords.

- ▶ Mode: Global Config Mode
- ▶ Privilege Level: Administrator
- ▶ Format: passwords min-length <P-1>

| Parameter | Value | Meaning |
|-----------|-------|------------------------------------|
| P-1 | 1..64 | Enter a number in the given range. |

54.1.2 passwords max-login-attempts

Set maximum login attempts for the users.

- ▶ Mode: Global Config Mode
- ▶ Privilege Level: Administrator
- ▶ Format: passwords max-login-attempts <P-1>

| Parameter | Value | Meaning |
|-----------|-------|------------------------------------|
| P-1 | 0..5 | Enter a number in the given range. |

54.1.3 passwords min-uppercase-chars

Set minimum upper case characters for user passwords.

- ▶ Mode: Global Config Mode
- ▶ Privilege Level: Administrator
- ▶ Format: passwords min-uppercase-chars <P-1>

| Parameter | Value | Meaning |
|-----------|-------|------------------------------------|
| P-1 | 0..16 | Enter a number in the given range. |

54.1.4 passwords min-lowercase-chars

Set minimum lower case characters for user passwords.

- ▶ Mode: Global Config Mode
- ▶ Privilege Level: Administrator
- ▶ Format: passwords min-lowercase-chars <P-1>

| Parameter | Value | Meaning |
|-----------|-------|------------------------------------|
| P-1 | 0..16 | Enter a number in the given range. |

54.1.5 passwords min-numeric-chars

Set minimum numeric characters for user passwords.

- ▶ Mode: Global Config Mode
- ▶ Privilege Level: Administrator
- ▶ Format: passwords min-numeric-chars <P-1>

| Parameter | Value | Meaning |
|-----------|-------|------------------------------------|
| P-1 | 0..16 | Enter a number in the given range. |

54.1.6 passwords min-special-chars

Set minimum special characters for user passwords.

- ▶ Mode: Global Config Mode
- ▶ Privilege Level: Administrator
- ▶ Format: passwords min-special-chars <P-1>

| Parameter | Value | Meaning |
|-----------|-------|------------------------------------|
| P-1 | 0..16 | Enter a number in the given range. |

54.2 show

Display device options and settings.

54.2.1 show passwords

Display password policies and options.

- ▶ **Mode:** Command is in all modes available.
- ▶ **Privilege Level:** Administrator
- ▶ **Format:** show passwords

55 Radius

55.1 authorization

Configure authorization parameters.

55.1.1 authorization network radius

Enable or disable the switch to accept VLAN assignment by the RADIUS server.

- ▶ Mode: Global Config Mode
- ▶ Privilege Level: Administrator
- ▶ Format: authorization network radius

■ no authorization network radius

Disable the option

- ▶ Mode: Global Config Mode
- ▶ Privilege Level: Administrator
- ▶ Format: no authorization network radius

55.2 radius

Configure RADIUS parameters.

55.2.1 radius accounting mode

Enable or disable RADIUS accounting function.

- ▶ Mode: Global Config Mode
- ▶ Privilege Level: Administrator
- ▶ Format: radius accounting mode

■ no radius accounting mode

Disable the option

- ▶ Mode: Global Config Mode
- ▶ Privilege Level: Administrator
- ▶ Format: no radius accounting mode

55.2.2 radius server attribute 4

Specifies the RADIUS client to use the NAS-IP Address attribute in the RADIUS requests.

- ▶ Mode: Global Config Mode
- ▶ Privilege Level: Administrator
- ▶ Format: radius server attribute 4 <P-1>

| Parameter | Value | Meaning |
|-----------|---------|-------------|
| P-1 | A.B.C.D | IP address. |

55.2.3 radius server acct add

Add a RADIUS accounting server.

► Mode: Global Config Mode

► Privilege Level: Administrator

► Format: radius server acct add <P-1> ip <P-2> [name <P-3>] [port <P-4>]

ip: RADIUS accounting server IP address.

[name]: RADIUS accounting server name.

[port]: RADIUS accounting server port (default: 1813).

| Parameter | Value | Meaning |
|-----------|----------|---|
| P-1 | 1..8 | Next RADIUS server valid index (it can be seen with '#show radius global' command). |
| P-2 | string | Hostname or IP address. |
| P-3 | string | Enter a user-defined text, max. 32 characters. |
| P-4 | 1..65535 | Enter port number between 1 and 65535 |

55.2.4 radius server acct delete

Delete a RADIUS accounting server.

► Mode: Global Config Mode

► Privilege Level: Administrator

► Format: radius server acct delete <P-1>

| Parameter | Value | Meaning |
|-----------|-------|----------------------|
| P-1 | 1..8 | RADIUS server index. |

55.2.5 radius server acct modify

Change a RADIUS accounting server parameters.

► Mode: Global Config Mode

► Privilege Level: Administrator

► Format: radius server acct modify <P-1> [name <P-2>] [port <P-3>] [status <P-4>] [secret [<P-5>]] [encrypted <P-6>]

[name]: RADIUS accounting server name.

[port]: RADIUS accounting server port (default: 1813).

[status]: Enable or disable a RADIUS accounting server entry.

[secret]: Configure the shared secret for the RADIUS accounting server.

[encrypted]: Configure the encrypted shared secret.

| Parameter | Value | Meaning |
|-----------|--------|--|
| P-1 | 1..8 | RADIUS server index. |
| P-2 | string | Enter a user-defined text, max. 32 characters. |

| Parameter | Value | Meaning |
|-----------|----------|---|
| P-3 | 1..65535 | Enter port number between 1 and 65535 |
| P-4 | enable | Enable the option. |
| | disable | Disable the option. |
| P-5 | string | Enter a user-defined text, max. 128 characters. |
| P-6 | string | Enter a user-defined text, max. 128 characters. |

55.2.6 radius server auth add

Add a RADIUS authentication server.

- ▶ Mode: Global Config Mode
 - ▶ Privilege Level: Administrator
 - ▶ Format: radius server auth add <P-1> ip <P-2> [name <P-3>] [port <P-4>]
- ip: RADIUS authentication server IP address.
 [name]: RADIUS authentication server name.
 [port]: RADIUS authentication server port (default: 1812).

| Parameter | Value | Meaning |
|-----------|----------|---|
| P-1 | 1..8 | Next RADIUS server valid index (it can be seen with '#show radius global' command). |
| P-2 | string | Hostname or IP address. |
| P-3 | string | Enter a user-defined text, max. 32 characters. |
| P-4 | 1..65535 | Enter port number between 1 and 65535 |

55.2.7 radius server auth delete

Delete a RADIUS authentication server.

- ▶ Mode: Global Config Mode
- ▶ Privilege Level: Administrator
- ▶ Format: radius server auth delete <P-1>

| Parameter | Value | Meaning |
|-----------|-------|----------------------|
| P-1 | 1..8 | RADIUS server index. |

55.2.8 radius server auth modify

Change a RADIUS authentication server parameters.

- ▶ **Mode:** Global Config Mode
- ▶ **Privilege Level:** Administrator
- ▶ **Format:** radius server auth modify <P-1> [name <P-2>] [port <P-3>] [msgauth <P-4>] [primary <P-5>] [status <P-6>] [secret [<P-7>]] [encrypted <P-8>]
[name]: RADIUS authentication server name.
[port]: RADIUS authentication server port (default: 1812).
[msgauth]: Enable or disable the message authenticator attribute for this server.
[primary]: Configure the primary RADIUS server.
[status]: Enable or disable a RADIUS authentication server entry.
[secret]: Configure the shared secret for the RADIUS authentication server.
[encrypted]: Configure the encrypted shared secret.

| Parameter | Value | Meaning |
|-----------|----------|---|
| P-1 | 1..8 | RADIUS server index. |
| P-2 | string | Enter a user-defined text, max. 32 characters. |
| P-3 | 1..65535 | Enter port number between 1 and 65535 |
| P-4 | enable | Enable the option. |
| | disable | Disable the option. |
| P-5 | enable | Enable the option. |
| | disable | Disable the option. |
| P-6 | enable | Enable the option. |
| | disable | Disable the option. |
| P-7 | string | Enter a user-defined text, max. 128 characters. |
| P-8 | string | Enter a user-defined text, max. 128 characters. |

55.2.9 radius server retransmit

Configure the retransmit value for the RADIUS server.

- ▶ **Mode:** Global Config Mode
- ▶ **Privilege Level:** Administrator
- ▶ **Format:** radius server retransmit <P-1>

| Parameter | Value | Meaning |
|-----------|-------|---|
| P-1 | 1..15 | Maximum number of retransmissions (default: 4). |

55.2.10 radius server timeout

Configure the RADIUS server timeout value.

- ▶ Mode: Global Config Mode
- ▶ Privilege Level: Administrator
- ▶ Format: radius server timeout <P-1>

| Parameter | Value | Meaning |
|-----------|-------|----------------------------------|
| P-1 | 1..30 | Timeout in seconds (default: 5). |

55.3 show

Display device options and settings.

55.3.1 show radius global

Display global RADIUS configuration.

- ▶ Mode: Command is in all modes available.
- ▶ Privilege Level: Guest
- ▶ Format: show radius global

55.3.2 show radius auth servers

Display all configured RADIUS authentication servers.

- ▶ Mode: Command is in all modes available.
- ▶ Privilege Level: Guest
- ▶ Format: show radius auth servers [<P-1>]

| Paramete | Value | Meaning |
|----------|-------|----------------------|
| P-1 | 1..8 | RADIUS server index. |

55.3.3 show radius auth statistics

Display RADIUS authentication server statistics.

- ▶ Mode: Command is in all modes available.
- ▶ Privilege Level: Guest
- ▶ Format: show radius auth statistics <P-1>

| Paramete | Value | Meaning |
|----------|-------|----------------------|
| P-1 | 1..8 | RADIUS server index. |

55.3.4 show radius acct statistics

Display RADIUS accounting server statistics.

- ▶ Mode: Command is in all modes available.
- ▶ Privilege Level: Guest
- ▶ Format: show radius acct statistics <P-1>

| Parameter | Value | Meaning |
|-----------|-------|----------------------|
| P-1 | 1..8 | RADIUS server index. |

55.3.5 show radius acct servers

Display all configured RADIUS accounting servers.

- ▶ Mode: Command is in all modes available.
- ▶ Privilege Level: Guest
- ▶ Format: show radius acct servers [<P-1>]

| Parameter | Value | Meaning |
|-----------|-------|----------------------|
| P-1 | 1..8 | RADIUS server index. |

55.4 clear

Clear several items.

55.4.1 clear radius

Clear the RADIUS statistics.

- ▶ Mode: Privileged Exec Mode
- ▶ Privilege Level: Administrator
- ▶ Format: clear radius <P-1>

| Parameter | Value | Meaning |
|-----------|------------|------------------------------|
| P-1 | statistics | Clear the RADIUS statistics. |

56 Remote Monitoring (RMON)

56.1 rmon-alarm

Create a RMON alarm action.

56.1.1 rmon-alarm add

Add RMON alarm.

- ▶ **Mode:** Global Config Mode
- ▶ **Privilege Level:** Operator
- ▶ **Format:** rmon-alarm add <P-1> [mib-variable <P-2>] [rising-threshold <P-3>] [falling-threshold <P-4>]
[mib-variable]: MIB variable
[rising-threshold]: Rising threshold
[falling-threshold]: Falling threshold

| Parameter | Value | Meaning |
|-----------|---------------|--|
| P-1 | 1..150 | Enter an index that uniquely identifies an entry in the alarm table. |
| P-2 | string | Enter an object identifier of the particular variable to be sampled, max. 32 characters. |
| P-3 | 1..2147483647 | Enter the rising threshold for the sampled statistic. |
| P-4 | 1..2147483647 | Enter the falling threshold for the sampled statistic. |

56.1.2 rmon-alarm enable

Enable RMON alarm.

- ▶ **Mode:** Global Config Mode
- ▶ **Privilege Level:** Operator
- ▶ **Format:** rmon-alarm enable <P-1>

| Parameter | Value | Meaning |
|-----------|--------|--|
| P-1 | 1..150 | Enter an index that uniquely identifies an entry in the alarm table. |

56.1.3 rmon-alarm disable

Disable RMON alarm.

- ▶ Mode: Global Config Mode
- ▶ Privilege Level: Operator
- ▶ Format: rmon-alarm disable <P-1>

| Parameter | Value | Meaning |
|-----------|--------|--|
| P-1 | 1..150 | Enter an index that uniquely identifies an entry in the alarm table. |

56.1.4 rmon-alarm delete

Delete RMON alarm.

- ▶ Mode: Global Config Mode
- ▶ Privilege Level: Operator
- ▶ Format: rmon-alarm delete <P-1>

| Parameter | Value | Meaning |
|-----------|--------|--|
| P-1 | 1..150 | Enter an index that uniquely identifies an entry in the alarm table. |

56.1.5 rmon-alarm modify

Modify RMON alarm parameters.

- ▶ Mode: Global Config Mode
 - ▶ Privilege Level: Operator
 - ▶ Format: rmon-alarm modify <P-1> [mib-variable <P-2>] [rising-threshold <P-3>] [falling-threshold <P-4>] [interval <P-5>] [sample-type <P-6>] [startup-alarm <P-7>] [rising-event <P-8>] [falling-event <P-9>]
- [mib-variable]: Enter the alarm mib variable.
- [rising-threshold]: Enter the alarm rising threshold.
- [falling-threshold]: Enter the alarm falling-threshold.
- [interval]: Enter the alarm interval in seconds over which the data is sampled.
- [sample-type]: Enter the alarm method of sampling the selected variable.
- [startup-alarm]: Enter the alarm type.
- [rising-event]: Enter the alarm rising-event index.
- [falling-event]: Enter the alarm falling-event index.

| Parameter | Value | Meaning |
|-----------|--------|--|
| P-1 | 1..150 | Enter an index that uniquely identifies an entry in the alarm table. |

| Parameter | Value | Meaning |
|-----------|----------------------|---|
| P-2 | string | Enter an object identifier of the particular variable to be sampled, max. 32 characters. |
| P-3 | 1..2147483647 | Enter the rising threshold for the sampled statistic. |
| P-4 | 1..2147483647 | Enter the falling threshold for the sampled statistic. |
| P-5 | 1..2147483647 | Enter the interval in seconds over which the data is sampled and compared with the rising and falling thresholds. |
| P-6 | absoluteValue | Variable is compared directly with the thresholds. |
| | deltaValue | Variable is subtracted from the current value and the difference compared with the thresholds. |
| P-7 | risingAlarm | Single rising alarm generated when the sample is greater than or equal to the rising threshold. |
| | fallingAlarm | Single falling alarm generated when the sample is less than or equal to the falling threshold. |
| | risingOrFallingAlarm | Single Rising alarm generated when the sample is greater than or equal to risingThreshold and single falling alarm generated when the sample is less than or equal to fallingThreshold. |
| P-8 | 1..65535 | Enter the index of the eventEntry that is used when a rising threshold is crossed. |
| P-9 | 1..65535 | Enter the index of the eventEntry that is used when a falling threshold is crossed. |

56.2 show

Display device options and settings.

56.2.1 show rmon statistics

Show RMON statistics configuration.

- ▶ Mode: Command is in all modes available.
- ▶ Privilege Level: Guest
- ▶ Format: show rmon statistics [<P-1>]

| Parameter | Value | Meaning |
|-----------|-------------------|---------|
| P-1 | slot no./port no. | |

56.2.2 show rmon alarm

Display configuration on RMON alarms.

- ▶ Mode: Command is in all modes available.
- ▶ Privilege Level: Guest
- ▶ Format: show rmon alarm

57 Script File

57.1 script

CLI Script File.

57.1.1 script apply

Executes the CLI script file available in the device.

- ▶ Mode: Privileged Exec Mode
- ▶ Privilege Level: Administrator
- ▶ Format: script apply <P-1>

| Parameter | Value | Meaning |
|-----------|--------|-----------|
| P-1 | string | Filename. |

57.1.2 script validate

Only validates the CLI script file available in the device.

- ▶ Mode: Privileged Exec Mode
- ▶ Privilege Level: Administrator
- ▶ Format: script validate <P-1>

| Parameter | Value | Meaning |
|-----------|--------|-----------|
| P-1 | string | Filename. |

57.1.3 script list system

List all the script files available in the device memory.

- ▶ Mode: Privileged Exec Mode
- ▶ Privilege Level: Administrator
- ▶ Format: script list system

57.1.4 script list envm

List all the script files available in external non-volatile memory.

- ▶ Mode: Privileged Exec Mode
- ▶ Privilege Level: Administrator
- ▶ Format: script list envm

57.1.5 script delete

Delete the CLI script files.

- ▶ Mode: Privileged Exec Mode
- ▶ Privilege Level: Administrator
- ▶ Format: script delete [<P-1>]

| Parameter | Value | Meaning |
|-----------|--------|-----------|
| P-1 | string | Filename. |

57.2 copy

Copy different kinds of items.

57.2.1 copy script envm

Copy script file from external non-volatile memory to specified destination.

▶ Mode: Privileged Exec Mode

▶ Privilege Level: Administrator

▶ Format: copy script envm <P-1> running-config nvm <P-2>

running-config: Copy script file from external non-volatile memory to the running-config.

nvm: Copy script file from external non-volatile memory to the non-volatile memory.

| Parameter | Value | Meaning |
|-----------|--------|--|
| P-1 | string | Filename. |
| P-2 | string | Enter a user-defined text, max. 32 characters. |

57.2.2 copy script remote

Copy script file from server to specified destination.

▶ Mode: Privileged Exec Mode

▶ Privilege Level: Administrator

▶ Format: copy script remote <P-1> running-config nvm <P-2>

running-config: Copy script file from file server to running-config.

nvm: Copy script file to non-volatile memory.

| Parameter | Value | Meaning |
|-----------|--------|---|
| P-1 | string | Enter a user-defined text, max. 128 characters. |
| P-2 | string | Enter a user-defined text, max. 32 characters. |

57.2.3 copy script nvm

Copy Script file from non-volatile memory to the specified destination.

- ▶ Mode: Privileged Exec Mode
- ▶ Privilege Level: Administrator
- ▶ Format: `copy script nvm <P-1> running-config envm <P-2> remote <P-3>`
`running-config`: Copy Script file from non-volatile system memory to running-config.
`envm`: Copy Script file to external non-volatile memory device.
`remote`: Copy Script file to file server.

| Parameter | Value | Meaning |
|-----------|--------|---|
| P-1 | string | Filename. |
| P-2 | string | Enter a user-defined text, max. 32 characters. |
| P-3 | string | Enter a user-defined text, max. 128 characters. |

57.2.4 copy script running-config nvm

Copy running configuration to non-volatile memory.

- ▶ Mode: Privileged Exec Mode
- ▶ Privilege Level: Administrator
- ▶ Format: `copy script running-config nvm <P-1> [all]`
`[all]`: Copy all running configuration to non-volatile memory.

| Parameter | Value | Meaning |
|-----------|--------|--|
| P-1 | string | Enter a user-defined text, max. 32 characters. |

57.2.5 copy script running-config envm

Copy running configuration to external non-volatile memory device.

- ▶ Mode: Privileged Exec Mode
- ▶ Privilege Level: Administrator
- ▶ Format: `copy script running-config envm <P-1> [all]`
`[all]`: Copy all running configuration to external non-volatile memory.

| Parameter | Value | Meaning |
|-----------|--------|--|
| P-1 | string | Enter a user-defined text, max. 32 characters. |

57.2.6 copy script running-config remote

Copy running configuration to a file server.

- ▶ Mode: Privileged Exec Mode
- ▶ Privilege Level: Administrator
- ▶ Format: copy script running-config remote <P-1> [all]
[all]: Copy all running configuration to file server.

| Parameter | Value | Meaning |
|-----------|--------|---|
| P-1 | string | Enter a user-defined text, max. 128 characters. |

57.3 show

Display device options and settings.

57.3.1 show script envm

Displays the content of the CLI script file present in the envm.

- ▶ Mode: Command is in all modes available.
- ▶ Privilege Level: Administrator
- ▶ Format: show script envm <P-1>

| Parameter | Value | Meaning |
|-----------|--------|-----------|
| P-1 | string | Filename. |

57.3.2 show script system

Displays the content of the CLI script file present in the device.

- ▶ Mode: Command is in all modes available.
- ▶ Privilege Level: Administrator
- ▶ Format: show script system <P-1>

| Parameter | Value | Meaning |
|-----------|--------|-----------|
| P-1 | string | Filename. |

58 Selftest

58.1 selftest

Configure the selftest settings.

58.1.1 selftest action

Configure the action that a selftest component should take.

- ▶ Mode: Global Config Mode
- ▶ Privilege Level: Administrator
- ▶ Format: selftest action <P-1> <P-2>

| Parameter | Value | Meaning |
|-----------|-----------|---|
| P-1 | task | Configure the action for task errors. |
| | resource | Configure the action for lack of resources. |
| | software | Configure the action for broken software integrity. |
| | hardware | Configure the action for detected hardware errors. |
| P-2 | log-only | Write a message to the logging file. |
| | send-trap | Send a trap to the management station. |
| | reboot | Reboot the device. |

58.1.2 selftest ramtest

Enable or disable the RAM selftest on cold start of the device. When disabled the device booting time is reduced.

- ▶ Mode: Global Config Mode
- ▶ Privilege Level: Administrator
- ▶ Format: selftest ramtest

■ no selftest ramtest

Disable the option

- ▶ Mode: Global Config Mode
- ▶ Privilege Level: Administrator
- ▶ Format: no selftest ramtest

58.1.3 selftest system-monitor

Enable or disable the System Monitor 1 access during the boot phase. Please note: If the System Monitor is disabled it is possible to loose access to the device permanently in case of loosing administrator password or mis-configuration.

- ▶ Mode: Global Config Mode
- ▶ Privilege Level: Administrator
- ▶ Format: selftest system-monitor

■ no selftest system-monitor

Disable the option

- ▶ Mode: Global Config Mode
- ▶ Privilege Level: Administrator
- ▶ Format: no selftest system-monitor

58.1.4 selftest boot-default-on-error

Enable or disable loading of the default configuration in case there is any error loading the configuration during boot phase. If disabled the system will be halted.

- ▶ Mode: Global Config Mode
- ▶ Privilege Level: Administrator
- ▶ Format: selftest boot-default-on-error

■ no selftest boot-default-on-error

Disable the option

- ▶ Mode: Global Config Mode
- ▶ Privilege Level: Administrator
- ▶ Format: no selftest boot-default-on-error

58.2 show

Display device options and settings.

58.2.1 show selftest action

Displays the actions of the device takes if an error occurs.

- ▶ Mode: Command is in all modes available.
- ▶ Privilege Level: Guest
- ▶ Format: show selftest action

58.2.2 show selftest settings

Displays the selftest settings.

- ▶ Mode: Command is in all modes available.
- ▶ Privilege Level: Guest
- ▶ Format: show selftest settings

59 Small Form-factor Pluggable (SFP)

59.1 show

Display device options and settings.

59.1.1 show sfp

Show info about plugged in SFP modules

- ▶ **Mode:** Command is in all modes available.
- ▶ **Privilege Level:** Guest
- ▶ **Format:** show sfp [<P-1>]

| Parameter | Value | Meaning |
|-----------|-------------------|---------|
| P-1 | slot no./port no. | |

60 Signal Contact

60.1 signal-contact

Configure the signal contact settings.

60.1.1 signal-contact mode

Configure the Signal Contact mode setting.

- ▶ Mode: Global Config Mode
- ▶ Privilege Level: Administrator
- ▶ Format: signal-contact <P-1> mode <P-2>

| Parameter | Value | Meaning |
|-----------|--------------------|---|
| P-1 | signal contact no. | |
| P-2 | manual | The signal contact's status is determined by the\nassociated manual setting (subcommand 'state'). |
| | monitor | The signal contact's status is determined by the\nassociated monitor settings. |
| | device-status | The signal contact's status is determined by the\ndevice status. |
| | security-status | The signal contact's status is determined by the\nsecurity status. |
| | dev-sec-status | The signal contact's status is determined by the\ndevice status and security status. |

60.1.2 signal-contact monitor link-failure

Sets the monitoring of the network connection(s).

- ▶ Mode: Global Config Mode
- ▶ Privilege Level: Administrator
- ▶ Format: signal-contact <P-1> monitor link-failure

| Parameter | Value | Meaning |
|-----------|--------------------|---------|
| P-1 | signal contact no. | |

■ no signal-contact monitor link-failure

Disable the option

- ▶ Mode: Global Config Mode
- ▶ Privilege Level: Administrator
- ▶ Format: no signal-contact <P-1> monitor link-failure

60.1.3 signal-contact monitor envm-not-in-sync

Sets the monitoring whether the external non-volatile memory device is in sync with the running configuration.

- ▶ Mode: Global Config Mode
- ▶ Privilege Level: Administrator
- ▶ Format: signal-contact <P-1> monitor envm-not-in-sync

| Parameter | Value | Meaning |
|-----------|--------------------|---------|
| P-1 | signal contact no. | |

■ no signal-contact monitor envm-not-in-sync

Disable the option

- ▶ Mode: Global Config Mode
- ▶ Privilege Level: Administrator
- ▶ Format: no signal-contact <P-1> monitor envm-not-in-sync

60.1.4 signal-contact monitor envm-removal

Sets the monitoring of the external non-volatile memory device removal.

- ▶ Mode: Global Config Mode
- ▶ Privilege Level: Administrator
- ▶ Format: signal-contact <P-1> monitor envm-removal

| Parameter | Value | Meaning |
|-----------|--------------------|---------|
| P-1 | signal contact no. | |

■ no signal-contact monitor envm-removal

Disable the option

- ▶ Mode: Global Config Mode
- ▶ Privilege Level: Administrator
- ▶ Format: no signal-contact <P-1> monitor envm-removal

60.1.5 signal-contact monitor temperature

Sets the monitoring of the device temperature.

- ▶ Mode: Global Config Mode
- ▶ Privilege Level: Administrator
- ▶ Format: signal-contact <P-1> monitor temperature

| Parameter | Value | Meaning |
|-----------|--------------------|---------|
| P-1 | signal contact no. | |

■ no signal-contact monitor temperature

Disable the option

- ▶ Mode: Global Config Mode
- ▶ Privilege Level: Administrator
- ▶ Format: no signal-contact <P-1> monitor temperature

60.1.6 signal-contact monitor ring-redundancy

Sets the monitoring of the ring-redundancy.

- ▶ Mode: Global Config Mode
- ▶ Privilege Level: Administrator
- ▶ Format: signal-contact <P-1> monitor ring-redundancy

| Parameter | Value | Meaning |
|-----------|--------------------|---------|
| P-1 | signal contact no. | |

■ no signal-contact monitor ring-redundancy

Disable the option

- ▶ Mode: Global Config Mode
- ▶ Privilege Level: Administrator
- ▶ Format: no signal-contact <P-1> monitor ring-redundancy

60.1.7 signal-contact monitor power-supply

Sets the monitoring of the power supply(s).

- ▶ Mode: Global Config Mode
- ▶ Privilege Level: Administrator
- ▶ Format: signal-contact <P-1> monitor power-supply <P-2>

| Parameter | Value | Meaning |
|-----------|--------------------|-------------------------|
| P-1 | signal contact no. | |
| P-2 | 1..2 | Number of power supply. |

■ no signal-contact monitor power-supply

Disable the option

- ▶ Mode: Global Config Mode
- ▶ Privilege Level: Administrator
- ▶ Format: no signal-contact <P-1> monitor power-supply <P-2>

60.1.8 signal-contact state

Configure the Signal Contact manual state (only takes immediate effect in manual mode).

- ▶ Mode: Global Config Mode
- ▶ Privilege Level: Administrator
- ▶ Format: signal-contact <P-1> state <P-2>

| Parameter | Value | Meaning |
|-----------|--------------------|--|
| P-1 | signal contact no. | |
| P-2 | open | Open the signal contact (only takes effect in the manual mode). |
| | close | Close the signal contact (only takes effect in the manual mode). |

60.1.9 signal-contact trap

Configure if a trap is sent when the Signal Contact changes state (in monitor mode).

- ▶ Mode: Global Config Mode
- ▶ Privilege Level: Administrator
- ▶ Format: signal-contact <P-1> trap

| Parameter | Value | Meaning |
|-----------|--------------------|---------|
| P-1 | signal contact no. | |

■ no signal-contact trap

Disable the option

- ▶ Mode: Global Config Mode
- ▶ Privilege Level: Administrator
- ▶ Format: no signal-contact <P-1> trap

60.2 signal-contact

Configure the signal contact interface settings.

60.2.1 signal-contact link-alarm

Configure the monitoring of the specific network ports.

- ▶ Mode: Interface Range Mode
- ▶ Privilege Level: Administrator
- ▶ Format: signal-contact <P-1> link-alarm

| Parameter | Value | Meaning |
|-----------|--------------------|---------|
| P-1 | signal contact no. | |

■ no signal-contact link-alarm

Disable the option

- ▶ Mode: Interface Range Mode
- ▶ Privilege Level: Administrator
- ▶ Format: no signal-contact <P-1> link-alarm

60.3 show

Display device options and settings.

60.3.1 show signal-contact

Display signal contact settings.

► **Mode:** Command is in all modes available.

► **Privilege Level:** Guest

► **Format:** show signal-contact <P-1> mode monitor state trap link-alarm module events all

mode: Display the signal contact mode.

monitor: Display the signal contact monitor settings.

state: Display the signal contact state (open/close).\nNote: This covers the signal contact's administrative\nsetting as well as its actual state.

trap: Display the signal contact trap information and settings.

link-alarm: Display the settings of the monitoring of the specific\nnetwork ports.

module: Display the settings of the monitoring of the specific\nmodules.

events: Display occurred device status events.

all: Display all signal contact settings for the specified\nsignal contact.

| Parameter | Value | Meaning |
|-----------|--------------------|---------|
| P-1 | signal contact no. | |

61 Switched Monitoring (SMON)

61.1 monitor

Configure port mirroring.

61.1.1 monitor session

Configure port mirroring.

▶ **Mode:** Global Config Mode

▶ **Privilege Level:** Operator

▶ **Format:** monitor session <P-1> destination interface <P-2> remote vlan <P-3>
source interface <P-4> direction <P-5> operation vlan <P-6> remote vlan <P-7> mode

destination: Configure the probe interface.

interface: Configure interface.

remote: Destination RSPAN configuration.

vlan: Set the destination RSPAN VLAN used to tag the mirrored frames.

source: Configure the source interface.

interface: Configure interface

direction: Select interface.

operation: Enable/disable mirroring on an interface.

vlan: Set the VLAN to mirror.

remote: Source RSPAN configuration.

vlan: Set the source RSPAN VLAN on which mirrored frames are expected.

mode: Enable/Disable port mirroring session. Note: does not affect the source or destination interfaces.

| Parameter | Value | Meaning |
|-----------|-------------------|--|
| P-1 | 1 | Monitor session index. |
| P-2 | slot no./port no. | |
| P-3 | integer | VLAN Mirror Remote VLAN ID List. |
| P-4 | slot no./port no. | |
| P-5 | none | None. |
| | tx | Packets that are transmitted on the source interfaces are copied to the destination interface. |
| | rx | Packets that are received on the source interfaces are copied to the destination interface. |
| | txrx | Packets that are transmitted or received on the source interfaces are copied to the destination interface. |
| P-6 | 0..4042 | Enter the VLAN ID. Entering of ID 0 disables the feature. |
| P-7 | integer | VLAN Mirror Remote VLAN ID List. |

■ **no monitor session**

Disable the option

▶ **Mode:** Global Config Mode

▶ **Privilege Level:** Operator

▶ **Format:** no monitor session <P-1> destination interface remote vlan source
interface <P-4> direction operation vlan remote vlan mode

61.2 show

Display device options and settings.

61.2.1 show monitor session

Display port monitor session settings.

- ▶ **Mode:** Command is in all modes available.
- ▶ **Privilege Level:** Guest
- ▶ **Format:** show monitor session <P-1>

| Parameter | Value | Meaning |
|-----------|-------|------------------------|
| P-1 | 1 | Monitor session index. |

61.3 clear

Clear several items.

61.3.1 clear monitor session

Delete configuration for this session.

- ▶ Mode: Privileged Exec Mode
- ▶ Privilege Level: Operator
- ▶ Format: clear monitor session <P-1>

| Parameter | Value | Meaning |
|-----------|-------|------------------------|
| P-1 | 1 | Monitor session index. |

62 Simple Network Management Protocol (SNMP)

62.1 snmp

Configure of SNMP versions and traps.

62.1.1 snmp access version v1

Enable or disable SNMP version V1.

- ▶ Mode: Global Config Mode
- ▶ Privilege Level: Administrator
- ▶ Format: snmp access version v1

■ no snmp access version v1

Disable the option

- ▶ Mode: Global Config Mode
- ▶ Privilege Level: Administrator
- ▶ Format: no snmp access version v1

62.1.2 snmp access version v2

Enable or disable SNMP version V2.

- ▶ Mode: Global Config Mode
- ▶ Privilege Level: Administrator
- ▶ Format: snmp access version v2

■ no snmp access version v2

Disable the option

- ▶ Mode: Global Config Mode
- ▶ Privilege Level: Administrator
- ▶ Format: no snmp access version v2

62.1.3 snmp access version v3

Enable or disable SNMP version V3.

- ▶ Mode: Global Config Mode
- ▶ Privilege Level: Administrator
- ▶ Format: snmp access version v3

■ no snmp access version v3

Disable the option

- ▶ Mode: Global Config Mode
- ▶ Privilege Level: Administrator
- ▶ Format: no snmp access version v3

62.1.4 snmp access port

Configure the SNMP access port.

- ▶ Mode: Global Config Mode
- ▶ Privilege Level: Administrator
- ▶ Format: snmp access port <P-1>

| Parameter | Value | Meaning |
|-----------|----------|--|
| P-1 | 1..65535 | Port number of the SNMP server (default: 161). |

62.1.5 snmp access snmp-over-802

Configure SNMPover802.

- ▶ Mode: Global Config Mode
- ▶ Privilege Level: Administrator
- ▶ Format: snmp access snmp-over-802

■ no snmp access snmp-over-802

Disable the option

- ▶ Mode: Global Config Mode
- ▶ Privilege Level: Administrator
- ▶ Format: no snmp access snmp-over-802

62.2 show

Display device options and settings.

62.2.1 show snmp access

Show SNMP access configuration settings.

- ▶ **Mode:** Command is in all modes available.
- ▶ **Privilege Level:** Guest
- ▶ **Format:** show snmp access

63 SNMP Community

63.1 snmp

Configure of SNMP versions and traps.

63.1.1 snmp community ro

SNMP v1/v2 read-only community.

- ▶ Mode: Global Config Mode
- ▶ Privilege Level: Administrator
- ▶ Format: snmp community ro

63.1.2 snmp community rw

SNMP v1/v2 read-write community.

- ▶ Mode: Global Config Mode
- ▶ Privilege Level: Administrator
- ▶ Format: snmp community rw

63.2 show

Display device options and settings.

63.2.1 show snmp community

Display SNMP v1/2 community.

- ▶ **Mode:** Command is in all modes available.
- ▶ **Privilege Level:** Administrator
- ▶ **Format:** show snmp community

64 SNMP Logging

64.1 logging

Logging configuration.

64.1.1 logging snmp-request get operation

Enable or disable logging of SNMP GET or SET requests.

- ▶ Mode: Global Config Mode
- ▶ Privilege Level: Administrator
- ▶ Format: logging snmp-request get operation <P-1>

| Parameter | Value | Meaning |
|-----------|---------|--|
| P-1 | enable | Enable logging of SNMP GET or SET requests. |
| | disable | Disable logging of SNMP GET or SET requests. |

■ no logging snmp-request get operation

Disable the option

- ▶ Mode: Global Config Mode
- ▶ Privilege Level: Administrator
- ▶ Format: no logging snmp-request get operation <P-1>

64.1.2 logging snmp-request get severity

Define severity level.

- ▶ Mode: Global Config Mode
- ▶ Privilege Level: Administrator
- ▶ Format: logging snmp-request get severity <P-1>

| Parameter | Value | Meaning |
|-----------|-----------------------|--|
| P-1 | emergency | System is unusable. System failure has occurred. |
| | alert | Action must be taken immediately. Unrecoverable failure of a component. System failure likely. |
| | critical | Recoverable failure of a component that may lead to system failure. |
| | error | Error conditions. Recoverable failure of a component. |
| | warning | Minor failure, e.g. misconfiguration of a component. |
| | notice | Normal but significant conditions. |
| | informational | Informational messages. |
| | debug | Debug-level messages. |
| | 0 | Same as emergency |
| | 1 | Same as alert |
| | 2 | Same as critical |
| | 3 | Same as error |
| | 4 | Same as warning |
| | 5 | Same as notice |
| 6 | Same as informational | |
| 7 | Same as debug | |

64.1.3 logging snmp-request set operation

Enable or disable logging of SNMP GET or SET requests.

- ▶ Mode: Global Config Mode
- ▶ Privilege Level: Administrator
- ▶ Format: logging snmp-request set operation <P-1>

| Parameter | Value | Meaning |
|-----------|---------|--|
| P-1 | enable | Enable logging of SNMP GET or SET requests. |
| | disable | Disable logging of SNMP GET or SET requests. |

■ no logging snmp-request set operation

Disable the option

- ▶ Mode: Global Config Mode
- ▶ Privilege Level: Administrator
- ▶ Format: no logging snmp-request set operation <P-1>

64.1.4 logging snmp-request set severity

Define severity level.

- ▶ Mode: Global Config Mode
- ▶ Privilege Level: Administrator
- ▶ Format: logging snmp-request set severity <P-1>

| Parameter | Value | Meaning |
|-----------|---------------|--|
| P-1 | emergency | System is unusable. System failure has occurred. |
| | alert | Action must be taken immediately. Unrecoverable failure of a component. System failure likely. |
| | critical | Recoverable failure of a component that may lead to system failure. |
| | error | Error conditions. Recoverable failure of a component. |
| | warning | Minor failure, e.g. misconfiguration of a component. |
| | notice | Normal but significant conditions. |
| | informational | Informational messages. |
| | debug | Debug-level messages. |
| | 0 | Same as emergency |
| | 1 | Same as alert |
| | 2 | Same as critical |
| | 3 | Same as error |
| | 4 | Same as warning |
| | 5 | Same as notice |
| | 6 | Same as informational |
| | 7 | Same as debug |

64.2 show

Display device options and settings.

64.2.1 show logging snmp

Show the SNMP logging settings.

- ▶ **Mode:** Command is in all modes available.
- ▶ **Privilege Level:** Guest
- ▶ **Format:** show logging snmp

65 Simple Network Time Protocol (SNTP)

65.1 sntp

Configure SNTP settings.

65.1.1 sntp client operation

Enable or disable the SNTP client

- ▶ Mode: Global Config Mode
- ▶ Privilege Level: Administrator
- ▶ Format: sntp client operation

■ no sntp client operation

Disable the option

- ▶ Mode: Global Config Mode
- ▶ Privilege Level: Administrator
- ▶ Format: no sntp client operation

65.1.2 sntp client operating-mode

Set the operating mode of the SNTP client. \n\n unicast-mode, the client sends a request to the SNTP Server. \n\n broadcast-mode, the client waits for a broadcast message from the SNTP Server.

- ▶ Mode: Global Config Mode
- ▶ Privilege Level: Administrator
- ▶ Format: sntp client operating-mode <P-1>

| Parameter | Value | Meaning |
|-----------|-----------|--------------------------------------|
| P-1 | unicast | Set the operating mode to unicast. |
| | broadcast | Set the operating mode to broadcast. |

65.1.3 sntp client request-interval

Set the SNTP client request interval in seconds. \n\nThe request-interval is only used in the operating-mode unicast.

- ▶ Mode: Global Config Mode
- ▶ Privilege Level: Administrator
- ▶ Format: sntp client request-interval <P-1>

| Parameter | Value | Meaning |
|-----------|---------|------------------------------------|
| P-1 | 5..3600 | Enter a number in the given range. |

65.1.4 sntp client broadcast-rcv-timeout

Set the SNTP client broadcast receive timeout in seconds. \n\nThe broadcast receive timeout is only used in the operating-mode broadcast.

- ▶ Mode: Global Config Mode
- ▶ Privilege Level: Administrator
- ▶ Format: sntp client broadcast-rcv-timeout <P-1>

| Parameter | Value | Meaning |
|-----------|-----------|------------------------------------|
| P-1 | 128..2048 | Enter a number in the given range. |

65.1.5 sntp client disable-after-sync

If this option is activated, the SNTP client disables itself \n\nonce it is synchronized to a SNTP server.

- ▶ Mode: Global Config Mode
- ▶ Privilege Level: Administrator
- ▶ Format: sntp client disable-after-sync

■ no sntp client disable-after-sync

Disable the option

- ▶ Mode: Global Config Mode
- ▶ Privilege Level: Administrator
- ▶ Format: no sntp client disable-after-sync

65.1.6 sntp client server add

Add a SNTP client server connection

- ▶ Mode: Global Config Mode
- ▶ Privilege Level: Administrator
- ▶ Format: sntp client server add <P-1> <P-2> [port <P-3>] [description <P-4>]
[port]: Set the port number of the external time server.
[description]: Description of the external time server

| Paramete | Value | Meaning |
|----------|----------|--|
| P-1 | 1..4 | Enter a number in the given range. |
| P-2 | string | Hostname or IP address. |
| P-3 | 1..65535 | Port number of SNTP Server (default 123). |
| P-4 | string | Enter a user-defined text, max. 32 characters. |

65.1.7 sntp client server delete

delete a SNTP client server connection

- ▶ Mode: Global Config Mode
- ▶ Privilege Level: Administrator
- ▶ Format: sntp client server delete <P-1>

| Paramete | Value | Meaning |
|----------|-------|------------------------------------|
| P-1 | 1..4 | Enter a number in the given range. |

65.1.8 sntp client server mode

Enable or disable a SNTP client server connection

- ▶ Mode: Global Config Mode
- ▶ Privilege Level: Administrator
- ▶ Format: sntp client server mode <P-1>

| Paramete | Value | Meaning |
|----------|-------|------------------------------------|
| P-1 | 1..4 | Enter a number in the given range. |

■ no sntp client server mode

Disable the option

- ▶ Mode: Global Config Mode
- ▶ Privilege Level: Administrator
- ▶ Format: no sntp client server mode <P-1>

65.1.9 sntp server operation

Enable or disable the SNTP server

- ▶ Mode: Global Config Mode
- ▶ Privilege Level: Administrator
- ▶ Format: sntp server operation

■ no sntp server operation

Disable the option

- ▶ Mode: Global Config Mode
- ▶ Privilege Level: Administrator
- ▶ Format: no sntp server operation

65.1.10 sntp server port

Set the local socket port number used to listen for client requests.

- ▶ Mode: Global Config Mode
- ▶ Privilege Level: Administrator
- ▶ Format: sntp server port <P-1>

| Parameter | Value | Meaning |
|-----------|----------|---|
| P-1 | 1..65535 | Port number of SNTP Server (default 123). |

65.1.11 sntp server only-if-synchronized

Set the disabling of the SNTP server function, \nif it is not synchronized to another external time reference

- ▶ Mode: Global Config Mode
- ▶ Privilege Level: Administrator
- ▶ Format: sntp server only-if-synchronized

■ no sntp server only-if-synchronized

Disable the option

- ▶ Mode: Global Config Mode
- ▶ Privilege Level: Administrator
- ▶ Format: no sntp server only-if-synchronized

65.1.12 sntp server broadcast operation

Enable or disable the SNTP server broadcast mode

- ▶ Mode: Global Config Mode
- ▶ Privilege Level: Administrator
- ▶ Format: sntp server broadcast operation

■ no sntp server broadcast operation

Disable the option

- ▶ Mode: Global Config Mode
- ▶ Privilege Level: Administrator
- ▶ Format: no sntp server broadcast operation

65.1.13 sntp server broadcast address

Set the SNTP server's broadcast or multicast IP address\n(default: 0.0.0.0 (none)).

- ▶ Mode: Global Config Mode
- ▶ Privilege Level: Administrator
- ▶ Format: sntp server broadcast address <P-1>

| Parameter | Value | Meaning |
|-----------|---------|-------------|
| P-1 | a.b.c.d | IP address. |

65.1.14 sntp server broadcast port

Set the destination socket port number used to send\nbroadcast or multicast messages to the client.

- ▶ Mode: Global Config Mode
- ▶ Privilege Level: Administrator
- ▶ Format: sntp server broadcast port <P-1>

| Parameter | Value | Meaning |
|-----------|----------|---|
| P-1 | 1..65535 | Port number of SNTP Server (default 123). |

65.1.15 sntp server broadcast interval

Set the SNTP server's interval in seconds for sending broadcast or multicast messages.

- ▶ Mode: Global Config Mode
- ▶ Privilege Level: Administrator
- ▶ Format: sntp server broadcast interval <P-1>

| Parameter | Value | Meaning |
|-----------|----------|------------------------------------|
| P-1 | 64..1024 | Enter a number in the given range. |

65.1.16 sntp server broadcast vlan

Set the SNTP server's broadcast VLAN ID used for sending broadcast or multicast messages.

- ▶ Mode: Global Config Mode
- ▶ Privilege Level: Administrator
- ▶ Format: sntp server broadcast vlan <P-1>

| Parameter | Value | Meaning |
|-----------|---------|--|
| P-1 | 0..4042 | Enter the VLAN ID. Entering of ID 0 uses the management VLAN ID. |

65.2 show

Display device options and settings.

65.2.1 show sntp global

Show SNTP configuration parameters and information.

- ▶ Mode: Command is in all modes available.
- ▶ Privilege Level: Guest
- ▶ Format: show sntp global

65.2.2 show sntp client status

Show SNTP client status.

- ▶ Mode: Command is in all modes available.
- ▶ Privilege Level: Guest
- ▶ Format: show sntp client status

65.2.3 show sntp client server

Show SNTP client server connections.

- ▶ Mode: Command is in all modes available.
- ▶ Privilege Level: Guest
- ▶ Format: show sntp client server [<P-1>]

| Parameter | Value | Meaning |
|-----------|-------|------------------------------------|
| P-1 | 1..4 | Enter a number in the given range. |

65.2.4 show sntp server status

Show SNTP server configuration parameters and information.

- ▶ **Mode:** Command is in all modes available.
- ▶ **Privilege Level:** Guest
- ▶ **Format:** show sntp server status

65.2.5 show sntp server broadcast

Show SNTP server broadcast configuration parameters.

- ▶ **Mode:** Command is in all modes available.
- ▶ **Privilege Level:** Guest
- ▶ **Format:** show sntp server broadcast

66 Spanning Tree

66.1 spanning-tree

Enable or disable the Spanning Tree protocol.

66.1.1 spanning-tree operation

Enable or disable the function.

- ▶ Mode: Global Config Mode
- ▶ Privilege Level: Operator
- ▶ Format: spanning-tree operation

■ no spanning-tree operation

Disable the option

- ▶ Mode: Global Config Mode
- ▶ Privilege Level: Operator
- ▶ Format: no spanning-tree operation

66.1.2 spanning-tree bpdu-filter

Enable or disable the BPDU filter on the edge ports.

- ▶ Mode: Global Config Mode
- ▶ Privilege Level: Operator
- ▶ Format: spanning-tree bpdu-filter

■ no spanning-tree bpdu-filter

Disable the option

- ▶ Mode: Global Config Mode
- ▶ Privilege Level: Operator
- ▶ Format: no spanning-tree bpdu-filter

66.1.3 spanning-tree bpdu-guard

Enable or disable the BPDU guard on the edge ports.

- ▶ Mode: Global Config Mode
- ▶ Privilege Level: Operator
- ▶ Format: spanning-tree bpdu-guard

■ no spanning-tree bpdu-guard

Disable the option

- ▶ Mode: Global Config Mode
- ▶ Privilege Level: Operator
- ▶ Format: no spanning-tree bpdu-guard

66.1.4 spanning-tree bpdu-migration-check

Force the specified port to transmit RST or MST BPDUs.

- ▶ Mode: Global Config Mode
- ▶ Privilege Level: Operator
- ▶ Format: spanning-tree bpdu-migration-check <P-1>

| Parameter | Value | Meaning |
|-----------|-------------------|---------|
| P-1 | slot no./port no. | |

66.1.5 spanning-tree forceversion

Set the force protocol version parameter.

- ▶ Mode: Global Config Mode
- ▶ Privilege Level: Operator
- ▶ Format: spanning-tree forceversion <P-1>

| Parameter | Value | Meaning |
|-----------|-------|--------------------------------------|
| P-1 | stp | Spanning Tree Protocol (STP). |
| | rstp | Rapid Spanning Tree Protocol (RSTP). |

66.1.6 spanning-tree forward-time

Set the Bridge Forward Delay parameter [s].

- ▶ Mode: Global Config Mode
- ▶ Privilege Level: Operator
- ▶ Format: spanning-tree forward-time <P-1>

| Paramete Value | Meaning |
|----------------|---|
| P-1 4..30 | Enter the bridge forward delay as an integer. |

66.1.7 spanning-tree hello-time

Set the Hello Time parameter [s].

- ▶ Mode: Global Config Mode
- ▶ Privilege Level: Operator
- ▶ Format: spanning-tree hello-time <P-1>

| Paramete Value | Meaning |
|----------------|---|
| P-1 1..2 | Set the Hello Time parameter (unit: seconds). |

66.1.8 spanning-tree hold-count

Set the bridge hold count parameter.

- ▶ Mode: Global Config Mode
- ▶ Privilege Level: Operator
- ▶ Format: spanning-tree hold-count <P-1>

| Paramete Value | Meaning |
|----------------|----------------------------------|
| P-1 1..40 | Set bridge hold count parameter. |

66.1.9 spanning-tree max-age

Set the bridge Max Age parameter.

- ▶ Mode: Global Config Mode
- ▶ Privilege Level: Operator
- ▶ Format: spanning-tree max-age <P-1>

| Parameter | Value | Meaning |
|-----------|-------|-----------------------------------|
| P-1 | 6..40 | Set the bridge Max Age parameter. |

66.1.10 spanning-tree ring-only-mode operation

Enable or disable the RSTP Ring Only Mode.

- ▶ Mode: Global Config Mode
- ▶ Privilege Level: Operator
- ▶ Format: spanning-tree ring-only-mode operation

■ no spanning-tree ring-only-mode operation

Disable the option

- ▶ Mode: Global Config Mode
- ▶ Privilege Level: Operator
- ▶ Format: no spanning-tree ring-only-mode operation

66.1.11 spanning-tree ring-only-mode first-port

Configure the first ring port.

- ▶ Mode: Global Config Mode
- ▶ Privilege Level: Operator
- ▶ Format: spanning-tree ring-only-mode first-port <P-1>

| Parameter | Value | Meaning |
|-----------|-------------------|---------|
| P-1 | slot no./port no. | |

66.1.12 spanning-tree ring-only-mode second-port

Configure the second ring port.

- ▶ Mode: Global Config Mode
- ▶ Privilege Level: Operator
- ▶ Format: spanning-tree ring-only-mode second-port <P-1>

| Parameter | Value | Meaning |
|-----------|-------------------|---------|
| P-1 | slot no./port no. | |

66.1.13 spanning-tree mst

MST instance related configuration.

- ▶ Mode: Global Config Mode
- ▶ Privilege Level: Operator
- ▶ Format: spanning-tree mst

66.2 spanning-tree

Enable or disable the Spanning Tree protocol on a port.

66.2.1 spanning-tree mode

Enable or disable the function.

- ▶ Mode: Interface Range Mode
- ▶ Privilege Level: Operator
- ▶ Format: spanning-tree mode

■ no spanning-tree mode

Disable the option

- ▶ Mode: Interface Range Mode
- ▶ Privilege Level: Operator
- ▶ Format: no spanning-tree mode

66.2.2 spanning-tree bpdu-flood

Enable or disable BPDU flooding on a port.

- ▶ Mode: Interface Range Mode
- ▶ Privilege Level: Operator
- ▶ Format: spanning-tree bpdu-flood

■ no spanning-tree bpdu-flood

Disable the option

- ▶ Mode: Interface Range Mode
- ▶ Privilege Level: Operator
- ▶ Format: no spanning-tree bpdu-flood

66.2.3 spanning-tree edge-auto

Enable or disable auto edge detection on a port.

- ▶ Mode: Interface Range Mode
- ▶ Privilege Level: Operator
- ▶ Format: spanning-tree edge-auto

■ no spanning-tree edge-auto

Disable the option

- ▶ Mode: Interface Range Mode
- ▶ Privilege Level: Operator
- ▶ Format: no spanning-tree edge-auto

66.2.4 spanning-tree edge-port

Enable or disable edge port usage on a port.

- ▶ Mode: Interface Range Mode
- ▶ Privilege Level: Operator
- ▶ Format: spanning-tree edge-port

■ no spanning-tree edge-port

Disable the option

- ▶ Mode: Interface Range Mode
- ▶ Privilege Level: Operator
- ▶ Format: no spanning-tree edge-port

66.2.5 spanning-tree guard-loop

Enable or disable the loop guard on a port.

- ▶ Mode: Interface Range Mode
- ▶ Privilege Level: Operator
- ▶ Format: spanning-tree guard-loop

■ **no spanning-tree guard-loop**

Disable the option

- ▶ Mode: Interface Range Mode
- ▶ Privilege Level: Operator
- ▶ Format: no spanning-tree guard-loop

66.2.6 spanning-tree guard-root

Enable or disable the root guard on a port.

- ▶ Mode: Interface Range Mode
- ▶ Privilege Level: Operator
- ▶ Format: spanning-tree guard-root

■ **no spanning-tree guard-root**

Disable the option

- ▶ Mode: Interface Range Mode
- ▶ Privilege Level: Operator
- ▶ Format: no spanning-tree guard-root

66.2.7 spanning-tree guard-tcn

Enable or disable the TCN guard on a port.

- ▶ Mode: Interface Range Mode
- ▶ Privilege Level: Operator
- ▶ Format: spanning-tree guard-tcn

■ **no spanning-tree guard-tcn**

Disable the option

- ▶ Mode: Interface Range Mode
- ▶ Privilege Level: Operator
- ▶ Format: no spanning-tree guard-tcn

66.2.8 spanning-tree cost

Specify the port path cost for STP, RSTP and CIST.

- ▶ Mode: Interface Range Mode
- ▶ Privilege Level: Operator
- ▶ Format: spanning-tree cost <P-1>

| Parameter | Value | Meaning |
|-----------|-------------|-----------------------------|
| P-1 | 0..20000000 | Specify the port path cost. |

66.2.9 spanning-tree priority

Specify the port priority for STP, RSTP and CIST.

- ▶ Mode: Interface Range Mode
- ▶ Privilege Level: Operator
- ▶ Format: spanning-tree priority <P-1>

| Parameter | Value | Meaning |
|-----------|--------|----------------------------|
| P-1 | 0..240 | Specify the port priority. |

66.3 show

Display device options and settings.

66.3.1 show spanning-tree global

Display the Common and Internal Spanning Tree information and settings.

- ▶ Mode: Command is in all modes available.
- ▶ Privilege Level: Guest
- ▶ Format: show spanning-tree global

66.3.2 show spanning-tree mst instance

Display summarized information and settings for all ports in an MST instance.

- ▶ Mode: Command is in all modes available.
- ▶ Privilege Level: Guest
- ▶ Format: show spanning-tree mst instance

66.3.3 show spanning-tree mst port

Display summarized information and settings for all ports in an MST instance.

- ▶ Mode: Command is in all modes available.
- ▶ Privilege Level: Guest
- ▶ Format: show spanning-tree mst port [<P-1>]

| Parameter | Value | Meaning |
|-----------|-------------------|---------|
| P-1 | slot no./port no. | |

66.3.4 show spanning-tree port

Spanning Tree information and settings for an interface.

- ▶ **Mode:** Command is in all modes available.
- ▶ **Privilege Level:** Guest
- ▶ **Format:** show spanning-tree port <P-1>

| Parameter | Value | Meaning |
|-----------|-------------------|---------|
| P-1 | slot no./port no. | |

67 Secure Shell (SSH)

67.1 ssh

Set SSH parameters.

67.1.1 ssh server

Enable or disable the SSH server.

- ▶ Mode: Global Config Mode
- ▶ Privilege Level: Administrator
- ▶ Format: ssh server

■ no ssh server

Disable the option

- ▶ Mode: Global Config Mode
- ▶ Privilege Level: Administrator
- ▶ Format: no ssh server

67.1.2 ssh timeout

Set the SSH connection idle timeout in minutes (default: 5).

- ▶ Mode: Global Config Mode
- ▶ Privilege Level: Administrator
- ▶ Format: ssh timeout <P-1>

| Parameter | Value | Meaning |
|-----------|--------|--|
| P-1 | 0..160 | Idle timeout of a session in minutes (default: 5). |

67.1.3 ssh port

Set the SSH server port number (default: 22).

- ▶ Mode: Global Config Mode
- ▶ Privilege Level: Administrator
- ▶ Format: ssh port <P-1>

| Parameter | Value | Meaning |
|-----------|----------|--|
| P-1 | 1..65535 | Port number of the SSH server (default: 22). |

67.1.4 ssh max-sessions

Set the maximum number of concurrent SSH sessions (default: 5).

- ▶ Mode: Global Config Mode
- ▶ Privilege Level: Administrator
- ▶ Format: ssh max-sessions <P-1>

| Parameter | Value | Meaning |
|-----------|-------|--|
| P-1 | 1..5 | Maximum number of concurrent SSH sessions. |

67.1.5 ssh outbound max-sessions

Set the maximum number of concurrent outbound SSH sessions (default: 5).

- ▶ Mode: Global Config Mode
- ▶ Privilege Level: Administrator
- ▶ Format: ssh outbound max-sessions <P-1>

| Parameter | Value | Meaning |
|-----------|-------|--|
| P-1 | 1..5 | Maximum number of concurrent SSH sessions. |

67.1.6 ssh outbound timeout

Set the SSH connection idle timeout in minutes (default: 5).

- ▶ Mode: Global Config Mode
- ▶ Privilege Level: Administrator
- ▶ Format: ssh outbound timeout <P-1>

| Paramete Value | Meaning |
|----------------|--|
| P-1 0..160 | Idle timeout of a session in minutes (default: 5). |

67.1.7 ssh key rsa

Generate or delete RSA key

- ▶ Mode: Global Config Mode
- ▶ Privilege Level: Administrator
- ▶ Format: ssh key rsa <P-1>

| Paramete Value | Meaning |
|----------------|--------------------|
| P-1 generate | Generates the item |
| delete | Deletes the item |

67.1.8 ssh key dsa

Generate or delete DSA key

- ▶ Mode: Global Config Mode
- ▶ Privilege Level: Administrator
- ▶ Format: ssh key dsa <P-1>

| Paramete Value | Meaning |
|----------------|--------------------|
| P-1 generate | Generates the item |
| delete | Deletes the item |

67.2 copy

Copy different kinds of items.

67.2.1 copy sshkey remote

Copy the SSH key from a server to the specified destination.

- ▶ Mode: Privileged Exec Mode
- ▶ Privilege Level: Administrator
- ▶ Format: copy sshkey remote <P-1> nvm

nvm: Copy the SSH key from a server to non-volatile memory.

| Parameter | Value | Meaning |
|-----------|--------|---|
| P-1 | string | Enter a user-defined text, max. 128 characters. |

67.2.2 copy sshkey envm

Copy the SSH key from external non-volatile memory to the specified destination.

- ▶ Mode: Privileged Exec Mode
- ▶ Privilege Level: Administrator
- ▶ Format: copy sshkey envm <P-1> nvm

nvm: Copy the SSH key from external non-volatile memory to non-volatile memory.

| Parameter | Value | Meaning |
|-----------|--------|---|
| P-1 | string | Enter a user-defined text, max. 128 characters. |

67.3 show

Display device options and settings.

67.3.1 show ssh

Show SSH server and client information.

- ▶ **Mode:** Command is in all modes available.
- ▶ **Privilege Level:** Guest
- ▶ **Format:** show ssh

68 Storm Control

68.1 storm-control

Configure the global storm-control settings.

68.1.1 storm-control flow-control

Enable or disable flow control globally.

- ▶ Mode: Global Config Mode
- ▶ Privilege Level: Operator
- ▶ Format: storm-control flow-control

■ no storm-control flow-control

Disable the option

- ▶ Mode: Global Config Mode
- ▶ Privilege Level: Operator
- ▶ Format: no storm-control flow-control

68.2 traffic-shape

Traffic shape commands.

68.2.1 traffic-shape bw

Set threshold value

- ▶ Mode: Interface Range Mode
- ▶ Privilege Level: Operator
- ▶ Format: traffic-shape bw <P-1>

| Parameter | Value | Meaning |
|-----------|--------|------------------------------------|
| P-1 | 0..100 | Enter a number in the given range. |

68.3 mtu

68.3.1 mtu

Set the MTU size (without VLAN tag size, because the VLAN tag is ignored for size calculation).

- ▶ Mode: Interface Range Mode
- ▶ Privilege Level: Operator
- ▶ Format: mtu <P-1>

| Parameter | Value | Meaning |
|-----------|-------------|------------------------------------|
| P-1 | 1518..12288 | Enter a number in the given range. |

68.4 mtu

68.4.1 mtu

Set the MTU size (without VLAN tag size, because the VLAN tag is ignored for size calculation).

- ▶ Mode: Interface Range Mode
- ▶ Privilege Level: Operator
- ▶ Format: mtu <P-1>

| Parameter | Value | Meaning |
|-----------|------------|------------------------------------|
| P-1 | 1518..1530 | Enter a number in the given range. |

68.5 mtu

68.5.1 mtu

Set the MTU size (without VLAN tag size, because the VLAN tag is ignored for size calculation).

- ▶ Mode: Interface Range Mode
- ▶ Privilege Level: Operator
- ▶ Format: mtu <P-1>

| Parameter | Value | Meaning |
|-----------|-------------|------------------------------------|
| P-1 | 1518..12288 | Enter a number in the given range. |

68.6 storm-control

Storm control commands

68.6.1 storm-control flow-control

Enable or disable flow control (802.3x) for this port.

- ▶ Mode: Interface Range Mode
- ▶ Privilege Level: Operator
- ▶ Format: storm-control flow-control

■ no storm-control flow-control

Disable the option

- ▶ Mode: Interface Range Mode
- ▶ Privilege Level: Operator
- ▶ Format: no storm-control flow-control

68.6.2 storm-control ingress unit

Set unit.

- ▶ Mode: Interface Range Mode
- ▶ Privilege Level: Operator
- ▶ Format: storm-control ingress unit <P-1>

| Parameter | Value | Meaning |
|-----------|---------|---|
| P-1 | percent | Metering unit expressed in percentage of bandwidth. |
| | pps | Metering unit expressed in packets per second. |

68.6.3 storm-control ingress threshold

Set threshold value. The rate limiter function calculates the threshold based on data packets sized 512 bytes. When the unit is set to pps, the maximum value is 24414 for 100Mb/s and 244140 for 1000Mb/s.

- ▶ Mode: Interface Range Mode
- ▶ Privilege Level: Operator
- ▶ Format: storm-control ingress threshold <P-1>

| Parameter | Value | Meaning |
|-----------|-------------|--|
| P-1 | 0..14880000 | Enter a number in the given range. If the configured unit is percent enter a number in (0..100) range. |

68.6.4 storm-control ingress unicast operation

Enable/disable ingress unicast storm control.

- ▶ Mode: Interface Range Mode
- ▶ Privilege Level: Operator
- ▶ Format: storm-control ingress unicast operation

■ no storm-control ingress unicast operation

Disable the option

- ▶ Mode: Interface Range Mode
- ▶ Privilege Level: Operator
- ▶ Format: no storm-control ingress unicast operation

68.6.5 storm-control ingress multicast operation

enable/disable ingress multicast storm control.

- ▶ Mode: Interface Range Mode
- ▶ Privilege Level: Operator
- ▶ Format: storm-control ingress multicast operation

■ no storm-control ingress multicast operation

Disable the option

- ▶ Mode: Interface Range Mode
- ▶ Privilege Level: Operator
- ▶ Format: no storm-control ingress multicast operation

68.6.6 storm-control ingress broadcast operation

Enable/disable ingress broadcast storm control.

- ▶ **Mode:** Interface Range Mode
- ▶ **Privilege Level:** Operator
- ▶ **Format:** storm-control ingress broadcast operation

■ no storm-control ingress broadcast operation

Disable the option

- ▶ **Mode:** Interface Range Mode
- ▶ **Privilege Level:** Operator
- ▶ **Format:** no storm-control ingress broadcast operation

68.7 show

Display device options and settings.

68.7.1 show storm-control flow-control

Global flow control status.

- ▶ Mode: Command is in all modes available.
- ▶ Privilege Level: Guest
- ▶ Format: show storm-control flow-control

68.7.2 show storm-control ingress

Show storm control ingress parameters.

- ▶ Mode: Command is in all modes available.
- ▶ Privilege Level: Guest
- ▶ Format: show storm-control ingress [<P-1>]

| Paramete | Value | Meaning |
|----------|-------------------|---------|
| P-1 | slot no./port no. | |

68.7.3 show traffic-shape

Show Traffic Shape Parameters.

- ▶ Mode: Command is in all modes available.
- ▶ Privilege Level: Guest
- ▶ Format: show traffic-shape

68.7.4 show mtu

Show mtu Parameters.

- ▶ **Mode:** Command is in all modes available.
- ▶ **Privilege Level:** Guest
- ▶ **Format:** show mtu

69 System

69.1 system

Set system related values e.g. name of the device, location of the device, contact data for the person responsible for the device, and pre-login banner text.

69.1.1 system name

Edit the name of the device. The system name consists of an alphanumeric ASCII character string with 0..255 characters.

- ▶ Mode: Global Config Mode
- ▶ Privilege Level: Operator
- ▶ Format: system name <P-1>

| Paramete Value | Meaning |
|----------------|---|
| P-1 | string |
| | Enter a user-defined text, max. 255 characters. |

69.1.2 system location

Edit the location of the device. The system location consists of an alphanumeric ASCII character string with 0..255 characters.

- ▶ Mode: Global Config Mode
- ▶ Privilege Level: Operator
- ▶ Format: system location <P-1>

| Paramete Value | Meaning |
|----------------|---|
| P-1 | string |
| | Enter a user-defined text, max. 255 characters. |

69.1.3 system contact

Edit the contact information for the person responsible for the device. The contact data consists of an alphanumeric ASCII character string with 0..255 characters.

- ▶ Mode: Global Config Mode
- ▶ Privilege Level: Operator
- ▶ Format: system contact <P-1>

| Parameter | Value | Meaning |
|-----------|--------|---|
| P-1 | string | Enter a user-defined text, max. 255 characters. |

69.1.4 system pre-login-banner operation

Enable or disable the pre-login banner. You use the pre-login banner to display a greeting or information to users before they login to the device.

- ▶ Mode: Global Config Mode
- ▶ Privilege Level: Administrator
- ▶ Format: system pre-login-banner operation

■ no system pre-login-banner operation

Disable the option

- ▶ Mode: Global Config Mode
- ▶ Privilege Level: Administrator
- ▶ Format: no system pre-login-banner operation

69.1.5 system pre-login-banner text

Edit the text for the pre-login banner (C printf format syntax allowed: \n\t) The device allows you to edit an alphanumeric ASCII character string with up to 512 characters.

- ▶ Mode: Global Config Mode
- ▶ Privilege Level: Administrator
- ▶ Format: system pre-login-banner text <P-1>

| Parameter | Value | Meaning |
|-----------|--------|---|
| P-1 | string | Enter a user-defined text, max. 512 characters (allowed characters are from ASCII 32 to 127). |

69.1.6 system resources operation

Enable or disable the measurement operation.

- ▶ Mode: Global Config Mode
- ▶ Privilege Level: Administrator
- ▶ Format: system resources operation

■ no system resources operation

Disable the option

- ▶ Mode: Global Config Mode
- ▶ Privilege Level: Administrator
- ▶ Format: no system resources operation

69.2 temperature

Configure the upper and lower temperature limits of the device. The device allows you to set the threshold as an integer from -99 through 99. You configure the temperatures in degrees Celsius.

69.2.1 temperature upper-limit

Configure the upper temperature limit.

- ▶ Mode: Global Config Mode
- ▶ Privilege Level: Administrator
- ▶ Format: temperature upper-limit <P-1>

| Parameter | Value | Meaning |
|-----------|---------|--|
| P-1 | -99..99 | Upper temperature threshold ([C], default 70). |

69.2.2 temperature lower-limit

Configure the lower temperature limit.

- ▶ Mode: Global Config Mode
- ▶ Privilege Level: Administrator
- ▶ Format: temperature lower-limit <P-1>

| Parameter | Value | Meaning |
|-----------|---------|---|
| P-1 | -99..99 | Lower temperature threshold ([C], default 0). |

69.3 show

Display device options and settings.

69.3.1 show eventlog

Show event log notice and warning entries with time stamp.

- ▶ Mode: Command is in all modes available.
- ▶ Privilege Level: Guest
- ▶ Format: show eventlog

69.3.2 show system info

Show system related information.

- ▶ Mode: Command is in all modes available.
- ▶ Privilege Level: Guest
- ▶ Format: show system info

69.3.3 show system pre-login-banner

Show pre-login banner status and text.

- ▶ Mode: Command is in all modes available.
- ▶ Privilege Level: Guest
- ▶ Format: show system pre-login-banner

69.3.4 show system flash-status

Show the flash memory statistics of the device.

- ▶ Mode: Command is in all modes available.
- ▶ Privilege Level: Guest
- ▶ Format: show system flash-status

69.3.5 show system temperature limits

Show temperature limits.

- ▶ Mode: Command is in all modes available.
- ▶ Privilege Level: Guest
- ▶ Format: show system temperature limits

69.3.6 show system temperature extremes

Show minimum and maximum recorded temperature.

- ▶ Mode: Command is in all modes available.
- ▶ Privilege Level: Guest
- ▶ Format: show system temperature extremes

69.3.7 show system temperature histogram

Show the temperature histogram of the device.

- ▶ Mode: Command is in all modes available.
- ▶ Privilege Level: Guest
- ▶ Format: show system temperature histogram

69.3.8 show system temperature counters

Display number of 20 centigrade C variations in maximum one hour period.

- ▶ Mode: Command is in all modes available.
- ▶ Privilege Level: Guest
- ▶ Format: show system temperature counters

69.3.9 show system resources

Display the system resources information (cpu utilization, memory and network cpu utilization).

- ▶ Mode: Command is in all modes available.
- ▶ Privilege Level: Guest
- ▶ Format: show system resources

69.3.10 show psu slot

Display power supply slots

- ▶ Mode: Command is in all modes available.
- ▶ Privilege Level: Guest
- ▶ Format: show psu slot

69.3.11 show psu unit

Display information for power supply units.

- ▶ Mode: Command is in all modes available.
- ▶ Privilege Level: Guest
- ▶ Format: show psu unit

70 Telnet

70.1 telnet

Set Telnet parameters.

70.1.1 telnet server

Enable or disable the telnet server.

- ▶ Mode: Global Config Mode
- ▶ Privilege Level: Administrator
- ▶ Format: telnet server

■ no telnet server

Disable the option

- ▶ Mode: Global Config Mode
- ▶ Privilege Level: Administrator
- ▶ Format: no telnet server

70.1.2 telnet timeout

Set the idle timeout for a telnet connection in minutes.

- ▶ Mode: Global Config Mode
- ▶ Privilege Level: Administrator
- ▶ Format: telnet timeout <P-1>

| Parameter | Value | Meaning |
|-----------|--------|--|
| P-1 | 0..160 | Idle timeout of a session in minutes (default: 5). |

70.1.3 telnet port

Set the listening port for the telnet server.

- ▶ Mode: Global Config Mode
- ▶ Privilege Level: Administrator
- ▶ Format: telnet port <P-1>

| Parameter | Value | Meaning |
|-----------|----------|---|
| P-1 | 1..65535 | Set the listening port for the telnet server. |

70.1.4 telnet max-sessions

Set the maximum number of sessions for the telnet server.

- ▶ Mode: Global Config Mode
- ▶ Privilege Level: Administrator
- ▶ Format: telnet max-sessions <P-1>

| Parameter | Value | Meaning |
|-----------|-------|--|
| P-1 | 1..5 | Set the maximum number of connections for the telnet server. |

70.2 telnet

70.2.1 telnet

Establish a telnet connection to a remote host.

- ▶ Mode: "User Mode" and "Privileged Exec Mode"
- ▶ Privilege Level: Guest
- ▶ Format: telnet <P-1> [<P-2>] [<P-3>] [<P-4>] [<P-5>]

| Parameter | Value | Meaning |
|-----------|----------|---|
| P-1 | string | Hostname or IP address. |
| P-2 | 1..65535 | Enter port number between 1 and 65535 |
| P-3 | debug | Display the current Telnet options. |
| P-4 | line | Set the outbound Telnet operational mode as linemode (only takes effect for the serial connection). |
| P-5 | echo | Enable local echo (only takes effect for the serial connection). |

70.3 show

Display device options and settings.

70.3.1 show telnet

Show telnet server information.

- ▶ **Mode:** Command is in all modes available.
- ▶ **Privilege Level:** Guest
- ▶ **Format:** show telnet

71 Traps

71.1 snmp

Configure of SNMP versions and traps.

71.1.1 snmp trap operation

Global enable/disable SNMP trap.

- ▶ Mode: Global Config Mode
- ▶ Privilege Level: Administrator
- ▶ Format: snmp trap operation

■ no snmp trap operation

Disable the option

- ▶ Mode: Global Config Mode
- ▶ Privilege Level: Administrator
- ▶ Format: no snmp trap operation

71.1.2 snmp trap mode

Enable/disable SNMP trap entry.

- ▶ Mode: Global Config Mode
- ▶ Privilege Level: Administrator
- ▶ Format: snmp trap mode <P-1>

| Parameter | Value | Meaning |
|-----------|--------|---------------------------------------|
| P-1 | string | <name> Trap name (1 to 32 characters) |

■ no snmp trap mode

Disable the option

- ▶ Mode: Global Config Mode
- ▶ Privilege Level: Administrator
- ▶ Format: no snmp trap mode <P-1>

71.1.3 snmp trap delete

Delete SNMP trap entry.

- ▶ Mode: Global Config Mode
- ▶ Privilege Level: Administrator
- ▶ Format: snmp trap delete <P-1>

| Parameter | Value | Meaning |
|-----------|--------|---------------------------------------|
| P-1 | string | <name> Trap name (1 to 32 characters) |

71.1.4 snmp trap add

Add SNMP trap entry.

- ▶ Mode: Global Config Mode
- ▶ Privilege Level: Administrator
- ▶ Format: snmp trap add <P-1> <P-2>

| Parameter | Value | Meaning |
|-----------|-----------|---------------------------------------|
| P-1 | string | <name> Trap name (1 to 32 characters) |
| P-2 | <a.b.c.d> | a.b.c.d Single IP address. |
| | a.b.c.d:n | a.b.c.d:n Address with port. |

71.2 show

Display device options and settings.

71.2.1 show snmp traps

Display SNMP traps.

- ▶ **Mode:** Command is in all modes available.
- ▶ **Privilege Level:** Guest
- ▶ **Format:** show snmp traps

72 User Management

72.1 show

Display device options and settings.

72.1.1 show custom-role global

Display the common information of custom role.

- ▶ **Mode:** Command is in all modes available.
- ▶ **Privilege Level:** Guest
- ▶ **Format:** show custom-role global [<P-1>]

| Paramete Value | Meaning |
|----------------|-------------------|
| r | |
| P-1 | slot no./port no. |

72.1.2 show custom-role commands

Display the included and excluded commands.

- ▶ **Mode:** Command is in all modes available.
- ▶ **Privilege Level:** Guest
- ▶ **Format:** show custom-role commands [<P-1>]

| Paramete Value | Meaning |
|----------------|-------------------|
| r | |
| P-1 | slot no./port no. |

73 Users

73.1 users

Manage Users and User Accounts.

73.1.1 users add

Add a new user.

- ▶ Mode: Global Config Mode
- ▶ Privilege Level: Administrator
- ▶ Format: users add <P-1>

| Paramete Value | Meaning |
|----------------|---|
| P-1 string | <user> User name (up to 32 characters). |

73.1.2 users delete

Delete an existing user.

- ▶ Mode: Global Config Mode
- ▶ Privilege Level: Administrator
- ▶ Format: users delete <P-1>

| Paramete Value | Meaning |
|----------------|---|
| P-1 string | <user> User name (up to 32 characters). |

73.1.3 users enable

Enable user.

- ▶ Mode: Global Config Mode
- ▶ Privilege Level: Administrator
- ▶ Format: users enable <P-1>

| Paramete Value | Meaning |
|----------------|---|
| P-1 string | <user> User name (up to 32 characters). |

73.1.4 users disable

Disable user.

- ▶ Mode: Global Config Mode
- ▶ Privilege Level: Administrator
- ▶ Format: users disable <P-1>

| Parameter | Value | Meaning |
|-----------|--------|---|
| P-1 | string | <user> User name (up to 32 characters). |

73.1.5 users password

Change user password.

- ▶ Mode: Global Config Mode
- ▶ Privilege Level: Administrator
- ▶ Format: users password <P-1> [<P-2>]

| Parameter | Value | Meaning |
|-----------|--------|--|
| P-1 | string | <user> User name (up to 32 characters). |
| P-2 | string | Enter a user-defined text, max. 64 characters. |

73.1.6 users snmpv3 authentication

Specify authentication setting for a user.

- ▶ Mode: Global Config Mode
- ▶ Privilege Level: Administrator
- ▶ Format: users snmpv3 authentication <P-1> <P-2>

| Parameter | Value | Meaning |
|-----------|--------|--|
| P-1 | string | <user> User name (up to 32 characters). |
| P-2 | md5 | MD5 as SNMPv3 user authentication mode. |
| | sha1 | SHA1 as SNMPv3 user authentication mode. |

73.1.7 users snmpv3 encryption

Specify encryption settings for a user.

- ▶ Mode: Global Config Mode
- ▶ Privilege Level: Administrator
- ▶ Format: users snmpv3 encryption <P-1> <P-2>

| Parameter | Value | Meaning |
|-----------|--------|---|
| P-1 | string | <user> User name (up to 32 characters). |
| P-2 | none | SNMPv3 encryption method is none. |
| | des | DES as SNMPv3 encryption method. |
| | aes128 | AES-128 as SNMPv3 encryption method. |

73.1.8 users access-role

Specify snmpv3 access role for a user.

- ▶ Mode: Global Config Mode
- ▶ Privilege Level: Administrator
- ▶ Format: users access-role <P-1> <P-2>

| Parameter | Value | Meaning |
|-----------|-------------------|---|
| P-1 | string | <user> User name (up to 32 characters). |
| P-2 | slot no./port no. | |

73.1.9 users lock-status

Set the lockout status of a specified user.

- ▶ Mode: Global Config Mode
- ▶ Privilege Level: Administrator
- ▶ Format: users lock-status <P-1> <P-2>

| Parameter | Value | Meaning |
|-----------|--------|---|
| P-1 | string | <user> User name (up to 32 characters). |
| P-2 | unlock | Unlock specific user. User can login again. |

73.1.10 users password-policy-check

Set password policy check option. The device checks the "minimum password length", regardless of the setting for this option.

- ▶ Mode: Global Config Mode
- ▶ Privilege Level: Administrator
- ▶ Format: users password-policy-check <P-1> <P-2>

| Parameter | Value | Meaning |
|-----------|---------|---|
| P-1 | string | <user> User name (up to 32 characters). |
| P-2 | enable | Enable the option. |
| | disable | Disable the option. |

73.2 show

Display device options and settings.

73.2.1 show users

Display users and user accounts information.

- ▶ **Mode:** Command is in all modes available.
- ▶ **Privilege Level:** Administrator
- ▶ **Format:** show users

74 Virtual LAN (VLAN)

74.1 name

74.1.1 name

Assign a name to a VLAN

- ▶ Mode: VLAN Database Mode
- ▶ Privilege Level: Operator
- ▶ Format: name <P-1> <P-2>

| Parameter | Value | Meaning |
|-----------|---------|--|
| P-1 | 1..4042 | Enter the VLAN ID. |
| P-2 | string | Enter a user-defined text, max. 32 characters. |

74.2 vlan-unaware-mode

74.2.1 vlan-unaware-mode

Enable or disable VLAN unaware mode.

- ▶ **Mode:** VLAN Database Mode
- ▶ **Privilege Level:** Operator
- ▶ **Format:** vlan-unaware-mode

■ **no vlan-unaware-mode**

Disable the option

- ▶ **Mode:** VLAN Database Mode
- ▶ **Privilege Level:** Operator
- ▶ **Format:** no vlan-unaware-mode

74.3 vlan

Creation and configuration of VLANS.

74.3.1 vlan add

Create a VLAN

- ▶ Mode: VLAN Database Mode
- ▶ Privilege Level: Operator
- ▶ Format: vlan add <P-1>

| Paramete | Value | Meaning |
|----------|---------|--------------------|
| P-1 | 1..4042 | Enter the VLAN ID. |

74.3.2 vlan delete

Delete a VLAN

- ▶ Mode: VLAN Database Mode
- ▶ Privilege Level: Operator
- ▶ Format: vlan delete <P-1>

| Paramete | Value | Meaning |
|----------|---------|--|
| P-1 | 2..4042 | Enter VLAN ID. VLAN ID 1 can not be deleted or created |

74.4 vlan

Configure 802.1Q port parameters for VLANs.

74.4.1 vlan acceptframe

Configure how to handle tagged/untagged frames received.

- ▶ Mode: Interface Range Mode
- ▶ Privilege Level: Operator
- ▶ Format: vlan acceptframe <P-1>

| Parameter | Value | Meaning |
|-----------|----------|--|
| P-1 | all | Untagged frames or priority frames received on this interface are accepted and \n assigned the value of the interface VLAN ID for this port. |
| | vlanonly | Only frames received with a VLAN tag will be forwarded. All other frames will be dropped. |

74.4.2 vlan ingressfilter

Enable/Disable application of Ingress Filtering Rules.

- ▶ Mode: Interface Range Mode
- ▶ Privilege Level: Operator
- ▶ Format: vlan ingressfilter

■ no vlan ingressfilter

Disable the option

- ▶ Mode: Interface Range Mode
- ▶ Privilege Level: Operator
- ▶ Format: no vlan ingressfilter

74.4.3 vlan priority

Configure the priority for untagged frames.

- ▶ Mode: Interface Range Mode
- ▶ Privilege Level: Operator
- ▶ Format: vlan priority <P-1>

| Parameter | Value | Meaning |
|-----------|-------|------------------------------------|
| P-1 | 0..7 | Enter a number in the given range. |

74.4.4 vlan pvid

Configure the VLAN id for a specific port.

- ▶ Mode: Interface Range Mode
- ▶ Privilege Level: Operator
- ▶ Format: vlan pvid <P-1>

| Parameter | Value | Meaning |
|-----------|---------|--------------------|
| P-1 | 1..4042 | Enter the VLAN ID. |

74.4.5 vlan tagging

Enable or disable tagging for a specific VLAN port.

- ▶ Mode: Interface Range Mode
- ▶ Privilege Level: Operator
- ▶ Format: vlan tagging <P-1>

| Parameter | Value | Meaning |
|-----------|---------|--------------------|
| P-1 | 1..4042 | Enter the VLAN ID. |

■ no vlan tagging

Disable the option

- ▶ Mode: Interface Range Mode
- ▶ Privilege Level: Operator
- ▶ Format: no vlan tagging <P-1>

74.4.6 vlan participation include

vlan participation to include

- ▶ Mode: Interface Range Mode
- ▶ Privilege Level: Operator
- ▶ Format: vlan participation include <P-1>

| Parameter | Value | Meaning |
|-----------|---------|--------------------|
| P-1 | 1..4042 | Enter the VLAN ID. |

74.4.7 vlan participation exclude

vlan participation to exclude

- ▶ Mode: Interface Range Mode
- ▶ Privilege Level: Operator
- ▶ Format: vlan participation exclude <P-1>

| Parameter | Value | Meaning |
|-----------|---------|--------------------|
| P-1 | 1..4042 | Enter the VLAN ID. |

74.4.8 vlan participation auto

vlan participation to auto

- ▶ Mode: Interface Range Mode
- ▶ Privilege Level: Operator
- ▶ Format: vlan participation auto <P-1>

| Parameter | Value | Meaning |
|-----------|---------|--------------------|
| P-1 | 1..4042 | Enter the VLAN ID. |

74.5 show

Display device options and settings.

74.5.1 show vlan id

Display configuration of a single specified VLAN.

- ▶ Mode: Command is in all modes available.
- ▶ Privilege Level: Guest
- ▶ Format: show vlan id <P-1>

| Parameter | Value | Meaning |
|-----------|---------|--------------------|
| P-1 | 1..4042 | Enter the VLAN ID. |

74.5.2 show vlan brief

Show general VLAN parameters.

- ▶ Mode: Command is in all modes available.
- ▶ Privilege Level: Guest
- ▶ Format: show vlan brief

74.5.3 show vlan port

Show VLAN configuration of a single port.

- ▶ Mode: Command is in all modes available.
- ▶ Privilege Level: Guest
- ▶ Format: show vlan port [<P-1>]

| Parameter | Value | Meaning |
|-----------|-------------------|---------|
| P-1 | slot no./port no. | |

74.5.4 show vlan member current

Show membership of ports in static VLAN or dynamically created.

- ▶ **Mode:** Command is in all modes available.
- ▶ **Privilege Level:** Guest
- ▶ **Format:** show vlan member current

74.5.5 show vlan member static

Show membership of ports in static VLAN.

- ▶ **Mode:** Command is in all modes available.
- ▶ **Privilege Level:** Guest
- ▶ **Format:** show vlan member static

74.6 network

Configure the inband and outband connectivity.

74.6.1 network management vlan

Configure the management VLAN ID of the switch.

- ▶ Mode: Privileged Exec Mode
- ▶ Privilege Level: Operator
- ▶ Format: network management vlan <P-1>

| Parameter | Value | Meaning |
|-----------|---------|--------------------|
| P-1 | 1..4042 | Enter the VLAN ID. |

74.6.2 network management priority dot1p

Configure the management VLAN priority of the switch.

- ▶ Mode: Privileged Exec Mode
- ▶ Privilege Level: Operator
- ▶ Format: network management priority dot1p <P-1>

| Parameter | Value | Meaning |
|-----------|-------|------------------------------------|
| P-1 | 0..7 | Enter a number in the given range. |

74.6.3 network management priority ip-dscp

Configure the management VLAN ip-dscp priority of the switch.

- ▶ Mode: Privileged Exec Mode
- ▶ Privilege Level: Operator
- ▶ Format: network management priority ip-dscp <P-1>

| Parameter | Value | Meaning |
|-----------|-------|------------------------------------|
| P-1 | 0..63 | Enter a number in the given range. |

75 Voice VLAN

75.1 voice

Configure voice VLAN.

75.1.1 voice vlan

Enable or disable the voice VLAN feature.

- ▶ Mode: Global Config Mode
- ▶ Privilege Level: Operator
- ▶ Format: voice vlan

■ no voice vlan

Disable the option

- ▶ Mode: Global Config Mode
- ▶ Privilege Level: Operator
- ▶ Format: no voice vlan

75.2 voice

Configure voice VLAN.

75.2.1 voice vlan vlan-id

Set and configure the vlan-id interface mode.

- ▶ Mode: Interface Range Mode
- ▶ Privilege Level: Operator
- ▶ Format: `voice vlan vlan-id <P-1> [dot1p <P-2>]`
[dot1p]: Set and configure the vlan id and dot1p interface mode.

| Parameter | Value | Meaning |
|-----------|---------|---|
| P-1 | 0..4042 | Enter the VLAN ID. Entering of ID 0 disables the feature. |
| P-2 | 0 | priority 0 |
| | 1 | priority 1 |
| | 2 | priority 2 |
| | 3 | priority 3 |
| | 4 | priority 4 |
| | 5 | priority 5 |
| | 6 | priority 6 |
| | 7 | priority 7 |
| | 255 | default |

75.2.2 voice vlan dot1p

Set and configure the dot1p voice vlan interface mode.

- ▶ Mode: Interface Range Mode
- ▶ Privilege Level: Operator
- ▶ Format: `voice vlan dot1p <P-1>`

| Parameter | Value | Meaning |
|-----------|-------|------------|
| P-1 | 0 | priority 0 |
| | 1 | priority 1 |
| | 2 | priority 2 |
| | 3 | priority 3 |
| | 4 | priority 4 |
| | 5 | priority 5 |
| | 6 | priority 6 |
| | 7 | priority 7 |
| | 255 | default |

75.2.3 voice vlan none

Configure the none voice VLAN interface mode.

- ▶ Mode: Interface Range Mode
- ▶ Privilege Level: Operator
- ▶ Format: voice vlan none

75.2.4 voice vlan untagged

Configure the untagged voice VLAN interface mode.

- ▶ Mode: Interface Range Mode
- ▶ Privilege Level: Operator
- ▶ Format: voice vlan untagged

75.2.5 voice vlan disable

Disable voice VLAN on the interface.

- ▶ Mode: Interface Range Mode
- ▶ Privilege Level: Operator
- ▶ Format: voice vlan disable

75.2.6 voice vlan auth

Set voice VLAN Authentication Mode on the interface.

- ▶ Mode: Interface Range Mode
- ▶ Privilege Level: Operator
- ▶ Format: voice vlan auth

■ no voice vlan auth

Disable the option

- ▶ Mode: Interface Range Mode
- ▶ Privilege Level: Operator
- ▶ Format: no voice vlan auth

75.2.7 voice vlan data priority

Trust/Untrust data traffic on the interface.

- ▶ Mode: Interface Range Mode
- ▶ Privilege Level: Operator
- ▶ Format: voice vlan data priority <P-1>

| Parameter | Value | Meaning |
|-----------|---------|---------------------------------------|
| P-1 | trust | Trust data traffic on an interface. |
| | untrust | Untrust data traffic on an interface. |

75.3 show

Display device options and settings.

75.3.1 show voice vlan global

Display the current global Voice VLAN admin mode.

- ▶ **Mode:** Command is in all modes available.
- ▶ **Privilege Level:** Guest
- ▶ **Format:** show voice vlan global

75.3.2 show voice vlan interface

Display a summary of the current Voice VLAN configuration for a specific port or for all ports.

- ▶ **Mode:** Command is in all modes available.
- ▶ **Privilege Level:** Guest
- ▶ **Format:** show voice vlan interface [<P-1>]

| Parameter | Value | Meaning |
|-----------|-------------------|---------|
| P-1 | slot no./port no. | |

A Further Support

■ Technical Questions

For technical questions, please contact any Hirschmann dealer in your area or Hirschmann directly.

You will find the addresses of our partners on the Internet at

<http://www.hirschmann.com>

Contact our support at

<https://hirschmann-support.belden.eu.com>

You can contact us

in the EMEA region at

- ▶ Tel.: +49 (0)1805 14-1538
- ▶ E-mail: hac.support@belden.com

in the America region at

- ▶ Tel.: +1 (717) 217-2270
- ▶ E-mail: inet-support.us@belden.com

in the Asia-Pacific region at

- ▶ Tel.: +65 6854 9860
- ▶ E-mail: inet-ap@belden.com

■ Hirschmann Competence Center

The Hirschmann Competence Center is ahead of its competitors:

- ▶ Consulting incorporates comprehensive technical advice, from system evaluation through network planning to project planning.
- ▶ Training offers you an introduction to the basics, product briefing and user training with certification.

The current technology and product training courses can be found at <http://www.hicomcenter.com>

- ▶ Support ranges from the first installation through the standby service to maintenance concepts.

With the Hirschmann Competence Center, you have decided against making any compromises. Our client-customized package leaves you free to choose the service components you want to use.

Internet:

<http://www.hicomcenter.com>



HIRSCHMANN

A **BELDEN** BRAND



HIRSCHMANN

A **BELDEN** BRAND

User Manual

Configuration HiOS-2S RED (Redundancy Switch)

The naming of copyrighted trademarks in this manual, even when not specially indicated, should not be taken to mean that these names may be considered as free in the sense of the trademark and tradename protection law and hence that they may be freely used by anyone.

© 2017 Hirschmann Automation and Control GmbH

Manuals and software are protected by copyright. All rights reserved. The copying, reproduction, translation, conversion into any electronic medium or machine scannable form is not permitted, either in whole or in part. An exception is the preparation of a backup copy of the software for your own use.

The performance features described here are binding only if they have been expressly agreed when the contract was made. This document was produced by Hirschmann Automation and Control GmbH according to the best of the company's knowledge. Hirschmann reserves the right to change the contents of this document without prior notice. Hirschmann can give no guarantee in respect of the correctness or accuracy of the information in this document.

Hirschmann can accept no responsibility for damages, resulting from the use of the network components or the associated operating software. In addition, we refer to the conditions of use specified in the license contract.

You can get the latest version of this manual on the Internet at the Hirschmann product site (www.hirschmann.com).

Hirschmann Automation and Control GmbH
Stuttgarter Str. 45-51
72654 Neckartenzlingen
Germany

Contents

| | |
|---|-----------|
| Safety instructions | 9 |
| About this Manual | 11 |
| Key | 13 |
| Introduction | 15 |
| 1 User interfaces | 17 |
| 1.1 Graphical user interface | 18 |
| 1.2 Command line interface | 19 |
| 1.2.1 Preparing the data connection | 19 |
| 1.2.2 CLI access using Telnet | 19 |
| 1.2.3 CLI using SSH (Secure Shell) | 22 |
| 1.2.4 CLI using the V.24 port | 24 |
| 1.3 System monitor | 26 |
| 1.3.1 Functional scope | 26 |
| 1.3.2 Starting the System Monitor | 26 |
| 2 Specifying the IP parameters | 29 |
| 2.1 IP parameter basics | 30 |
| 2.1.1 IP address (version 4) | 30 |
| 2.1.2 Netmask | 31 |
| 2.1.3 Classless Inter-Domain Routing | 33 |
| 2.2 Specifying the IP parameters using the CLI | 34 |
| 2.3 Specifying the IP parameters using HiDiscovery | 36 |
| 2.4 Specifying the IP parameters using the graphical user interface | 38 |
| 2.5 Specifying the IP parameters using BOOTP | 39 |
| 2.6 Specifying the IP parameters using DHCP | 40 |
| 2.7 Management address conflict detection | 42 |
| 2.7.1 Active and passive detection | 42 |
| 3 Access to the device | 43 |
| 3.1 Authentication lists | 44 |
| 3.1.1 Applications | 44 |
| 3.1.2 Policies | 44 |
| 3.1.3 Managing authentication lists | 45 |
| 3.1.4 Adjust the settings | 45 |
| 3.2 User management | 47 |
| 3.2.1 Access roles | 47 |
| 3.2.2 Managing user accounts | 48 |
| 3.2.3 Default setting | 48 |
| 3.2.4 Changing default passwords | 49 |
| 3.2.5 Setting up a new user account | 49 |
| 3.2.6 Deactivating the user account | 51 |
| 3.2.7 Adjusting policies for passwords | 51 |
| 3.3 SNMP access | 53 |
| 3.3.1 SNMPv1/v2 access | 53 |
| 3.3.2 SNMPv3 access | 53 |
| 3.4 Service Shell | 55 |

| | | |
|----------|--|-----------|
| 4 | Managing configuration profiles | 57 |
| 4.1 | Detecting changed settings | 58 |
| 4.2 | Saving the settings | 59 |
| 4.2.1 | Saving the configuration profile in the device | 59 |
| 4.2.2 | Backup the configuration profile on a remote server | 60 |
| 4.2.3 | Saving the configuration profile in external memory | 61 |
| 4.2.4 | Exporting a configuration profile | 62 |
| 4.3 | Loading settings | 63 |
| 4.3.1 | Activating a configuration profile | 63 |
| 4.3.2 | Loading the configuration profile from the external memory | 64 |
| 4.3.3 | Importing a configuration profile | 65 |
| 4.4 | Reset the device to the factory defaults | 67 |
| 4.4.1 | Using the graphical user interface or CLI | 67 |
| 4.4.2 | Using the System Monitor | 67 |
| 5 | Loading software updates | 69 |
| 5.1 | Software update from the PC | 70 |
| 5.2 | Software update from a server | 71 |
| 5.3 | Software update from the external memory | 72 |
| 5.3.1 | Manually—initiated by the administrator | 72 |
| 5.3.2 | Automatically—initiated by the device | 72 |
| 5.4 | Loading an older software | 74 |
| 6 | Configuring the ports | 75 |
| 6.1 | Enabling/disabling the port | 76 |
| 6.2 | Selecting the operating mode | 77 |
| 7 | Assistance in the protection from unauthorized access | 79 |
| 7.1 | Changing the SNMPv1/v2 community | 80 |
| 7.2 | Disabling SNMPv1/v2 | 81 |
| 7.3 | Disabling HTTP | 82 |
| 7.4 | Disabling Telnet | 83 |
| 7.5 | Disabling the HiDiscovery access | 84 |
| 7.6 | Activating the IP access restriction | 85 |
| 7.7 | Adjusting the session timeouts | 87 |
| 8 | Controlling the data traffic | 89 |
| 8.1 | Helping protect against unauthorized access | 90 |
| 9 | Synchronizing the system time in the network | 91 |
| 9.1 | Basic settings | 92 |
| 9.1.1 | Setting the time | 92 |
| 9.1.2 | Automatic daylight saving time changeover | 93 |
| 9.2 | SNTP | 94 |
| 9.2.1 | Preparation | 95 |
| 9.2.2 | Defining settings of the SNTP client | 96 |
| 9.2.3 | Specifying SNTP server settings | 96 |
| 9.3 | PTP | 98 |
| 9.3.1 | Types of clocks | 98 |
| 9.3.2 | Best Master Clock algorithm | 99 |

| | | |
|-----------|---|------------|
| 9.3.3 | Delay measurement | 100 |
| 9.3.4 | PTP domains | 100 |
| 9.3.5 | Using PTP | 101 |
| 10 | Network load control | 103 |
| 10.1 | Direct packet distribution | 104 |
| 10.1.1 | Learning MAC addresses | 105 |
| 10.1.2 | Aging of learned MAC addresses | 105 |
| 10.1.3 | Static address entries | 105 |
| 10.2 | Multicasts | 107 |
| 10.2.1 | Example of a Multicast application | 107 |
| 10.2.2 | IGMP snooping | 107 |
| 10.3 | Rate limiter | 112 |
| 10.4 | QoS/Priority | 113 |
| 10.4.1 | Description of prioritization | 113 |
| 10.4.2 | Handling of received priority information | 114 |
| 10.4.3 | VLAN tagging | 115 |
| 10.4.4 | IP ToS (Type of Service) | 116 |
| 10.4.5 | Handling of traffic classes | 116 |
| 10.4.6 | Queue management | 117 |
| 10.4.7 | Management prioritization | 118 |
| 10.4.8 | Setting prioritization | 118 |
| 10.5 | Flow control | 122 |
| 10.5.1 | Halfduplex or fullduplex link | 123 |
| 10.5.2 | Setting up the Flow Control | 123 |
| 11 | VLANs | 125 |
| 11.1 | Examples of VLANs | 126 |
| 11.1.1 | Example 1 | 126 |
| 11.1.2 | Example 2 | 129 |
| 11.2 | Guest / Unauthenticated VLAN | 133 |
| 11.3 | RADIUS VLAN assignment | 135 |
| 11.4 | Creating a Voice VLAN | 136 |
| 11.5 | VLAN unaware mode | 137 |
| 12 | Redundancy | 139 |
| 12.1 | Network Topology vs. Redundancy Protocols | 140 |
| 12.1.1 | Network topologies | 141 |
| 12.1.2 | Redundancy Protocols | 142 |
| 12.1.3 | Combinations of Redundancies | 142 |
| 12.2 | Media Redundancy Protocol (MRP) | 144 |
| 12.2.1 | Network Structure | 144 |
| 12.2.2 | Reconfiguration time | 145 |
| 12.2.3 | Advanced mode | 145 |
| 12.2.4 | Prerequisites for MRP | 145 |
| 12.2.5 | Example Configuration | 146 |
| 12.3 | Device Level Ring (DLR) | 150 |
| 12.3.1 | Device Roles | 150 |
| 12.3.2 | Error Detection | 152 |
| 12.3.3 | Neighbor Check process | 154 |
| 12.3.4 | Sign On Process | 154 |
| 12.3.5 | Example Configuration | 155 |
| 12.4 | Parallel Redundancy Protocol (PRP) | 157 |
| 12.4.1 | Implementation | 157 |
| 12.4.2 | LRE functionality | 158 |
| 12.4.3 | PRP Network Structure | 159 |

| | | |
|-----------|--|------------|
| 12.4.4 | Connecting RedBoxes and DANPs to a PRP network | 159 |
| 12.4.5 | Example Configuration | 160 |
| 12.5 | High-availability Seamless Redundancy (HSR) | 162 |
| 12.5.1 | Implementation | 162 |
| 12.5.2 | HSR Network Structure | 163 |
| 12.6 | Spanning Tree | 169 |
| 12.6.1 | Basics | 170 |
| 12.6.2 | Rules for Creating the Tree Structure | 173 |
| 12.6.3 | Examples | 175 |
| 12.6.4 | The Rapid Spanning Tree Protocol | 178 |
| 12.6.5 | Configuring the device | 181 |
| 12.6.6 | Guards | 183 |
| 12.6.7 | Ring only mode | 186 |
| 12.6.8 | RSTP over HSR | 186 |
| 12.7 | Link Aggregation | 188 |
| 12.7.1 | Methods of Operation | 188 |
| 12.7.2 | Link Aggregation Example | 189 |
| 12.8 | Link Backup | 190 |
| 12.8.1 | Fail Back Description | 190 |
| 12.8.2 | Example Configuration | 191 |
| 13 | Operation diagnosis | 193 |
| 13.1 | Sending SNMP traps | 194 |
| 13.1.1 | List of SNMP traps | 195 |
| 13.1.2 | SNMP traps for configuration activity | 195 |
| 13.1.3 | SNMP trap setting | 196 |
| 13.1.4 | ICMP messaging | 196 |
| 13.2 | Monitoring the Device Status | 197 |
| 13.2.1 | Events which can be monitored | 197 |
| 13.2.2 | Configuring the Device Status | 198 |
| 13.2.3 | Displaying the Device Status | 199 |
| 13.3 | Security Status | 200 |
| 13.3.1 | Events which can be monitored | 200 |
| 13.3.2 | Configuring the Security Status | 201 |
| 13.3.3 | Displaying the Security Status | 202 |
| 13.4 | Out-of-Band signaling | 203 |
| 13.4.1 | Controlling the Signal contact | 203 |
| 13.4.2 | Monitoring the Device and Security Statuses | 204 |
| 13.5 | Port status indication | 206 |
| 13.6 | Port event counter | 207 |
| 13.6.1 | Detecting non-matching duplex modes | 207 |
| 13.7 | Auto-Disable | 209 |
| 13.8 | Displaying the SFP status | 211 |
| 13.9 | Topology discovery | 212 |
| 13.9.1 | Displaying the Topology discovery results | 212 |
| 13.9.2 | LLDP-Med | 213 |
| 13.10 | Detecting loops | 214 |
| 13.11 | Reports | 215 |
| 13.11.1 | Global settings | 215 |
| 13.11.2 | Syslog | 217 |
| 13.11.3 | System Log | 218 |
| 13.11.4 | Audit Trail | 218 |
| 13.12 | Network analysis with TCPdump | 220 |
| 13.13 | Monitoring the data traffic | 221 |
| 13.13.1 | Port Mirroring | 221 |

| | |
|---|------------|
| 13.14 Self-test | 223 |
| 14 Advanced functions of the device | 225 |
| 14.1 Using the device as a DHCP server | 226 |
| 14.1.1 IP Addresses assigned per port or per VLAN | 226 |
| 14.1.2 DHCP server static IP address example | 227 |
| 14.1.3 DHCP server dynamic IP address range example | 227 |
| 14.2 MRP-IEEE | 229 |
| 14.2.1 MRP operation | 229 |
| 14.2.2 MRP timers | 230 |
| 14.2.3 MMRP | 230 |
| 14.2.4 MVRP | 232 |
| 14.3 CLI client | 234 |
| 15 Industry Protocols | 235 |
| 15.1 IEC 61850/MMS | 236 |
| 15.1.1 Switch model for IEC 61850 | 236 |
| 15.1.2 Integration into a Control System | 237 |
| 15.2 Modbus TCP | 239 |
| 15.2.1 Client/Server Modbus TCP/IP Mode | 239 |
| 15.2.2 Supported Functions and Memory Mapping | 240 |
| 15.2.3 Example Configuration | 242 |
| 15.3 EtherNet/IP | 244 |
| 15.3.1 Integration into a Control System | 244 |
| 15.3.2 EtherNet/IP Entity Parameters | 246 |
| 15.4 PROFINET | 256 |
| 15.4.1 Integration into a Control System | 258 |
| 15.4.2 PROFINET Parameter | 264 |
| A Setting up the configuration environment | 269 |
| A.1 Setting up a DHCP/BOOTP server | 270 |
| A.2 Setting up a DHCP server with Option 82 | 274 |
| A.3 Preparing access via SSH | 277 |
| A.3.1 Generating a key on the device | 277 |
| A.3.2 Loading your own key onto the device | 277 |
| A.3.3 Preparing the SSH client program | 279 |
| A.4 HTTPS certificate | 281 |
| A.4.1 HTTPS certificate management | 281 |
| A.4.2 Access through HTTPS | 282 |
| B Appendix | 283 |
| B.1 Literature references | 284 |
| B.2 Maintenance | 285 |
| B.3 Management Information Base (MIB) | 286 |
| B.4 List of RFCs | 288 |
| B.5 Underlying IEEE Standards | 290 |
| B.6 Underlying IEC Norms | 291 |
| B.7 Underlying ANSI Norms | 292 |
| B.8 Technical Data | 293 |

| | | |
|----------|----------------------------------|------------|
| B.9 | Copyright of integrated Software | 294 |
| B.10 | Abbreviations used | 295 |
| C | Index | 297 |
| D | Further support | 301 |
| E | Readers' Comments | 302 |

Safety instructions

 **WARNING**

UNCONTROLLED MACHINE ACTIONS

To avoid uncontrolled machine actions caused by data loss, configure all the data transmission devices individually.

Before you start any machine which is controlled via data transmission, be sure to complete the configuration of all data transmission devices.

Failure to follow these instructions can result in death, serious injury, or equipment damage.

About this Manual

The “Configuration” user manual contains the information you need to start operating the device. It takes you step by step from the first startup operation through to the basic settings for operation in your environment.

The “Installation” user manual contains a device description, safety instructions, a description of the display, and the other information that you need to install the device.

The “Graphical User Interface” reference manual contains detailed information on using the graphical user interface to operate the individual functions of the device.

The “Command Line Interface” reference manual contains detailed information on using the Command Line Interface to operate the individual functions of the device.

The Industrial HiVision Network Management software provides you with additional options for smooth configuration and monitoring:

- ▶ Auto-topology discovery
- ▶ Browser interface
- ▶ Client/server structure
- ▶ Event handling
- ▶ Event log
- ▶ Simultaneous configuration of multiple devices
- ▶ Graphical user interface with network layout
- ▶ SNMP/OPC gateway

Key

The designations used in this manual have the following meanings:

| | |
|----------------------|--|
| ▶ | List |
| □ | Work step |
| ■ | Subheading |
| Link | Cross-reference with link |
| Note: | A note emphasizes an important fact or draws your attention to a dependency. |
| <code>Courier</code> | ASCII representation in the graphical user interface |

 Execution in the Graphical User Interface

 Execution in the Command Line Interface

Introduction

The device has been developed for use in a harsh industrial environment. Accordingly, the installation process has been kept simple. Thanks to the selected default settings, you only have to enter a few settings before starting to operate the device.

1 User interfaces

The device allows you to specify the settings of the device using the following user interfaces.

| User interface | Can be reached through ... | Prerequisite |
|--------------------------------|--|-----------------------------|
| Graphical User Interface (GUI) | Ethernet (In-Band) | Web browser |
| Command Line Interface (CLI) | Ethernet (In-Band) V.24 (Out-of-Band) | Terminal emulation software |
| System monitor | V.24 (Out-of-Band) | Terminal emulation software |

Table 1: User interfaces for accessing the management of the device

1.1 Graphical user interface

■ System requirements

To open the graphical user interface, you need the desktop version of a Web browser with HTML5 and JavaScript support.

Note: Third-party software such as Web browsers validate certificates based on criteria such as their expiration date and current cryptographic parameter recommendations. Old certificates can cause errors, for example, when they expire or cryptographic recommendations change. Upload your own, up-to-date certificate or regenerate the certificate with the latest firmware to solve validation conflicts with third-party software.

■ Starting the graphical user interface

The prerequisite for starting the graphical user interface is that the IP parameters are configured in the device. See [“Specifying the IP parameters” on page 29](#).

- Start your Web browser.
- Write the IP address of the device in the address field of the Web browser.
Use the following form: `https://xxx.xxx.xxx.xxx`
The Web browser sets up the connection to the device and displays the Login page.
- If you want to change the language of the graphical user interface, click the appropriate link in the top right corner of the Login page.
- Enter the user name.
- Enter the password.
- Click the *Login* button.
The Web browser displays the graphical user interface.

1.2 Command line interface

The Command Line Interface enables you to use the functions of the device through a local or remote connection.

The Command Line Interface provides IT specialists with a familiar environment for configuring IT devices. As an experienced user or administrator, you have knowledge about the basics and about using Hirschmann devices.

1.2.1 Preparing the data connection

Information for assembling and starting up your device can be found in the “Installation” user manual.

- Connect the device with the network. The network parameters must be set correctly for the data connection to be successful.

You can access the user interface of the Command Line Interface for example, with the freeware program *PuTTY*.

This program is provided on the product CD.

- Install the *PuTTY* program on your computer.

1.2.2 CLI access using Telnet

■ Telnet connection using Windows

Note: Telnet is only installed as standard in Windows versions before Windows Vista.

- Start the *Command Prompt* program on your computer.
- Enter the command `telnet <IP_address>`.

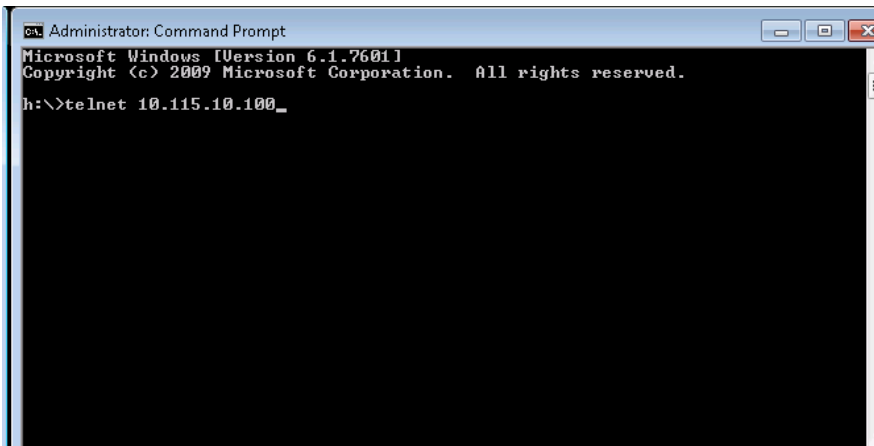

Figure 1: *Command Prompt*: Setting up the Telnet connection to the device

■ Telnet connection using PuTTY

- Start the *PuTTY* program on your computer.

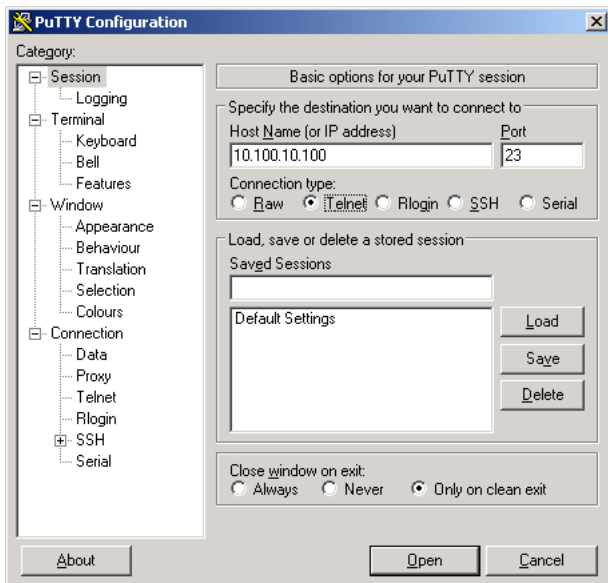

Figure 2: *PuTTY* input screen

- In the *Host Name (or IP address)* field you enter the IP address of your device. The IP address (a.b.c.d) consists of 4 decimal numbers with values from 0 to 255. The 4 decimal numbers are separated by points.
- To select the connection type, select the *Telnet* radio button in the *Connection type* range.
- Click the *Open* button to set up the data connection to your device.

CLI appears on the screen with a window for entering the user name. The device enables up to 5 users to have access to the Command Line Interface at the same time.

```
User: admin
Password:*****
```

Figure 3: *Login screen in CLI*

Note: Change the password during the first startup procedure.

- Enter the user name. The default user name is `admin`. Press the <Enter> key.
- Enter the password. The default password is `private`. Press the <Enter> key. The device offers the possibility to change the user name and the password later in the Command Line Interface. These entries are case-sensitive.

The device displays the CLI start screen with the command prompt:

(RED) >

```
Copyright (c) 2011-2017 Hirschmann Automation and Control GmbH
All rights reserved
HiOS-2S Release 7.0.11.1.0
(Build date Jun 25 2017)

System Name   : HiOS-2S-1000000000
Management IP : 10.115.46.205
Subnet Mask   : 255.255.224.0
Base MAC      : 90-80-10-10-10-10
System Time   : 2017-07-21 09:57:14

NOTE: Enter '?' for Command Help. Command help displays all options
that are valid for the particular mode.
For the syntax of a particular command form, please
consult the documentation.

* (RED) >
```

Figure 4: Start screen of CLI

1.2.3 CLI using SSH (Secure Shell)

- Start the *PuTTY* program on your computer.

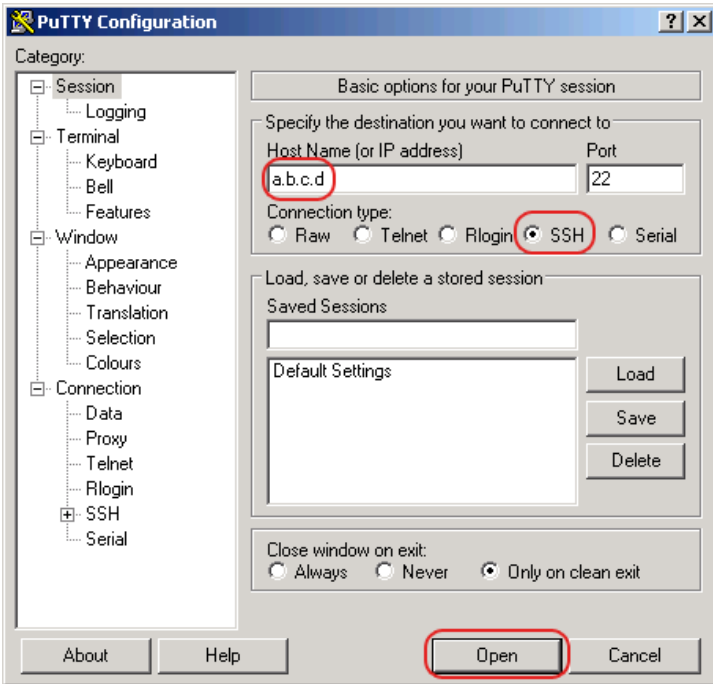

Figure 5: *PuTTY* input screen

- In the *Host Name (or IP address)* field you enter the IP address of your device. The IP address (a.b.c.d) consists of 4 decimal numbers with values from 0 to 255. The 4 decimal numbers are separated by points.
- To specify the connection type, select the *SSH* radio button in the *Connection type* range.
- After selecting and setting the required parameters, the device enables you to set up the data connection using SSH. Click the *Open* button to set up the data connection to your device. Depending on the device and the time at which SSH was configured, setting up the connection takes up to a minute.

When you first login to your device, towards the end of the connection setup, the *PuTTY* program displays a security alert message and gives you the option of checking the fingerprint of the key.



Figure 6: Security alert prompt for the fingerprint

- Check the fingerprint. This helps protect yourself from unwelcome guests.
- If the fingerprint matches that of the device key, click the *Yes* button.

The device allows you to display the finger prints of the device keys with the CLI command `show ssh` or in the *Device Security > Management Access > Server* dialog, *SSH* tab.

Note: For experienced network administrators, another way of accessing your device through an SSH is by using the OpenSSH Suite. To set up the data connection, enter the following command:

```
ssh admin@10.149.112.53
```

`admin` is the user name.

`10.149.112.53` is the IP address of your device.

CLI appears on the screen with a window for entering the user name. The device enables up to 5 users to have access to the Command Line Interface at the same time.

```
login as: adminadmin@a.b.c.d's password:
```

`a.b.c.d` is the IP address of your device.

- Enter the user name. The default user name is `admin`. Press the <Enter> key.
- Enter the password. The default password is `private`. Press the <Enter> key. The device offers the possibility to change the user name and the password later in the Command Line Interface. These entries are case-sensitive.

The device displays the CLI start screen.

Note: This device is a security-relevant product. Change the password during the first startup procedure.

```
login as: admin
admin@10.115.46.205's password:

Copyright (c) 2011-2012 Hirschmann Automation and Control GmbH
All rights reserved

HMIOS Release 201209-01.1.00
(Build date Jun 25 2013)

System Name      : HMIOS-2S-RED-2012
Management IP    : 10.115.46.205
Subnet Mask      : 255.255.224.0
Base MAC         : 90:80:70:00:00:00
System Time      : 2013-07-31 10:23:47

NOTE: Enter '?' for Command Help.  Command help displays all options
      that are valid for the particular mode.
      For the syntax of a particular command form, please
      consult the documentation.

* (HMIOS) >
```

Figure 7: Start screen of CLI

1.2.4 CLI using the V.24 port

The V.24 interface is a serial interface for the local connection of an external network management station (VT100 terminal or PC with terminal emulation). The interface allows you to set up a data connection to the Command Line Interface (CLI) and to the system monitor.

| VT 100 terminal settings | |
|--------------------------|------------|
| Speed | 9600 bit/s |
| Data | 8 bit |
| Stopbit | 1 bit |
| Handshake | off |
| Parity | none |

- Connect the device to a terminal using V.24. Alternatively connect the device to a COM port of your PC using terminal emulation based on VT100 and press any key.
- Alternatively you set up the serial data connection to the device using V.24 with the *PuTTY* program. Press the <Enter> key.

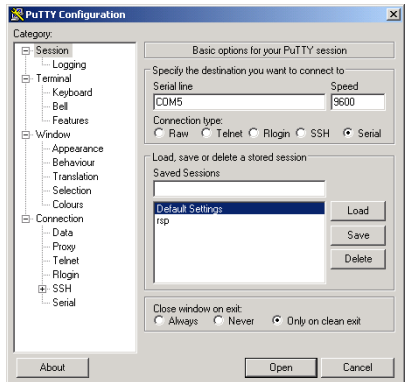

Figure 8: Serial data connection using V.24 with the PuTTY program

After the data connection has been set up successfully, the device displays a window for entering the user name.

Note: You can configure the V.24 interface as a terminal/CLI interface.

Press any key on your terminal keyboard a number of times until the login screen indicates the CLI mode.

- Enter the user name. The default user name is `admin`. Press the <Enter> key.
- Enter the password. The default password is `private`. Press the <Enter> key. The device offers the possibility to change the user name and the password later in the Command Line Interface. These entries are case-sensitive.

```
Copyright (c) 2012-2014 Hirschmann Automation and Control GmbH
All rights reserved
HMP Release: 2012-04-26 12:30:00
(Build date: 2012-04-26 12:30)

System Name : HMP-825510742000
Management IP : 10.0.1.32
Subnet Mask : 255.255.255.0
Base MAC : 80:00:00:00:00:00
System Time : 2012-07-25 10:10:00

User:admin
Password:*****
```

Figure 9: Logging in to the Command Line Interface program

```
NOTE: Enter '?' for Command Help. Command help displays all opt
that are valid for the particular mode.
For the syntax of a particular command form, please
consult the documentation.

! ( )>
```

Figure 10: CLI screen after login

1.3 System monitor

The System Monitor allows you to set basic operating parameters before starting the operating system.

1.3.1 Functional scope

In the System Monitor, you carry out the following tasks, for example:

- ▶ Managing the operating system and verifying the software image
- ▶ Updating the operating system
- ▶ Starting the operating system
- ▶ Deleting configuration profiles, resetting the device to the factory defaults
- ▶ Checking boot code information

1.3.2 Starting the System Monitor

Prerequisite:

- ▶ Terminal cable for connecting the device to your PC (available as an optional accessory).
- ▶ PC with VT100 terminal emulation (such as the *PuTTY* program) or serial terminal

Perform the following steps:

- Use the terminal cable to connect the V.24 interface of the device with the COM port of the PC.
- Start the VT100 terminal emulation on the PC.
- Specify the following transmission parameters:

| VT 100 terminal settings | |
|--------------------------|------------|
| Speed | 9600 bit/s |
| Data | 8 bit |
| Stopbit | 1 bit |
| Handshake | off |
| Parity | none |

- Set up a connection to the device.
- Switch on the device. If the device is already on, reboot it.
The screen displays the following message after rebooting:
Press <1> to enter System Monitor 1.
- Press the <1> key within 3 seconds.
The device starts the System Monitor. The screen displays the following view:

```
System Monitor 1
(Selected OS: ...-7.0 (2017-11-20 19:17))

1  Manage operating system
2  Update operating system
3  Start selected operating system
4  Manage configurations
5  Show boot code information
q  End (reset and reboot)
```

```
sysMon1>
```

Figure 11: System Monitor 1 screen display

- Select a menu item by entering the number.
- To leave a submenu and return to the main menu of System Monitor 1, press the <ESC> key.

2 Specifying the IP parameters

When you install the device for the first time enter the IP parameters.

The device provides the following options for entering the IP parameters during the first installation:

- ▶ **Entry using the Command Line Interface.**
You choose this “Out-of-Band” method if you preconfigure your device outside its operating environment, or if you restore the network access (“In-Band”) to the device.
- ▶ **Entry using the HiDiscovery protocol.**
You choose this “In-Band” method on a previously installed network device or if you have another Ethernet connection between your PC and the device
- ▶ **Configuration using the external memory.**
You choose this method if you are replacing a device with a device of the same type and have already saved the configuration in the external memory.
- ▶ **Using BOOTP.**
You choose this “In-Band” method to configure the installed device using BOOTP. You need a BOOTP server for this method. The BOOTP server assigns the configuration data to the device using its MAC address. The DHCP mode is the default mode for the configuration data reference.
- ▶ **Configuration using DHCP.**
You choose this “In-Band” method to configure the installed device using DHCP. You need a DHCP server for this method. The DHCP server assigns the configuration data to the device using its MAC address or its system name.
- ▶ **Configuration using the graphical user interface.**
If the device already has an IP address and is reachable using the network, then the graphical user interface provides you with another option for configuring the IP parameters.

2.1 IP parameter basics

2.1.1 IP address (version 4)

The IP addresses consist of 4 bytes. Write these 4 bytes in decimal notation, separated by a decimal point.

RFC 1340 written in 1992, defines 5 IP Address classes.

| Class | Network address | Host address | Address range |
|-------|-----------------|--------------|------------------------------|
| A | 1 Byte | 3 Bytes | 0.0.0.0 to 127.255.255.255 |
| B | 2 Bytes | 2 Bytes | 128.0.0.0 to 191.255.255.255 |
| C | 3 Bytes | 1 Byte | 192.0.0.0 to 223.255.255.255 |
| D | | | 224.0.0.0 to 239.255.255.255 |
| E | | | 240.0.0.0 to 255.255.255.255 |

Table 2: IP address classes

The first byte of an IP address is the network address. The worldwide leading regulatory board for assigning network addresses is the IANA ("Internet Assigned Numbers Authority"). If you require an IP address block, contact your Internet Service Provider (ISP). Your ISP contacts their local higher-level organization to reserve an IP address block:

- ▶ APNIC (Asia Pacific Network Information Center)
Asia/Pacific Region
- ▶ ARIN (American Registry for Internet Numbers)
Americas and Sub-Saharan Africa
- ▶ LACNIC (Regional Latin-American and Caribbean IP Address Registry)
Latin America and some Caribbean Islands
- ▶ RIPE NCC (Réseaux IP Européens)
Europe and Surrounding Regions

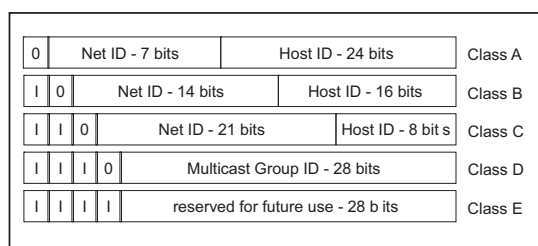

Figure 12: Bit representation of the IP address

The IP addresses belong to class A when their first bit is a zero, for example, the first octet is less than 128.

The IP address belongs to class B if the first bit is a one and the second bit is a zero, for example, the first octet is between 128 and 191.

The IP address belongs to class C when the first 2 bits are a one, for example, the first octet is higher than 191.

Assigning the host address (host ID) is the responsibility of the network operator. The network operator alone is responsible for the uniqueness of the assigned IP addresses.

2.1.2 Netmask

Routers and Gateways subdivide large networks into subnetworks. The netmask assigns the IP addresses of the individual devices to a particular subnetwork.

You perform subnetwork division using the netmask in much the same way as the division of the network addresses (net id) into classes A to C.

Set the bits of the host address (host id) that represent the mask to one. Set the remaining host address bits to zero (see the following examples).

Example of a subnet mask:

Decimal notation
255.255.192.0

Binary notation
11111111.11111111.11000000.00000000

Example of IP addresses with subnetwork assignment when applying the subnet mask:

Decimal notation
129.218.65.17

Binary notation
10000001.11011010.01000001.00010001

Decimal notation
129.218.129.17

Binary notation
10000001.11011010.10000001.00010001

■ Example of how the netmask is used

In a large network it is possible that Gateways and routers separate the management agent from its network management station. How does addressing work in such a case?

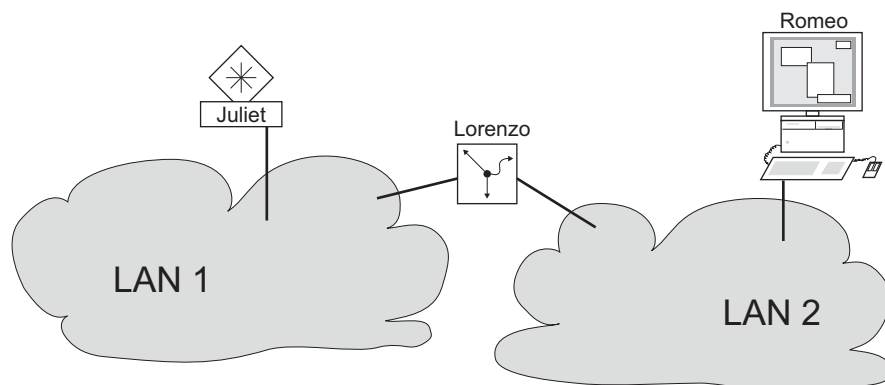

Figure 13: The management agent is separated from its network management station by a router

The network management station “Romeo” wants to send data to the management agent “Juliet”. Romeo knows Juliet’s IP address and also knows that the router “Lorenzo” knows the way to Juliet.

Romeo therefore puts his message in an envelope and writes Juliet’s IP address as the destination address; for the source address he writes his own IP address on the envelope.

Romeo then places this envelope in a second one with Lorenzo’s MAC address as the destination and his own MAC address as the source. This process is comparable to going from Layer 3 to Layer 2 of the ISO/OSI base reference model.

Finally, Romeo puts the entire data packet into the mailbox which is comparable to going from Layer 2 to Layer 1, that means to sending the data packet over the Ethernet.

Lorenzo receives the letter, removes the outer envelope and recognizes from the inner envelope that the letter is meant for Juliet. He places the inner envelope in a new outer envelope and searches his address list (the ARP table) for Juliet’s MAC address; he writes her MAC address on the outer envelope as the destination address and his own MAC address as the source address. He then places the entire data packet in the mail box.

Juliet receives the letter and removes the outer envelope. She finds the inner envelope with Romeo’s IP address. Opening the inner envelope and reading its contents corresponds to transferring the message to the higher protocol layers of the ISO/OSI layer model.

Juliet would now like to send a reply to Romeo. She places her reply in an envelope with Romeo’s IP address as destination and her own IP address as source. But where is she to send the answer? For she did not receive Romeo’s MAC address. It was lost when Lorenzo replaced the outer envelope.

In the MIB, Juliet finds Lorenzo listed under the variable `hmNetGatewayIPAddr` as a means of communicating with Romeo. She therefore puts the envelope with the IP addresses in a further envelope with Lorenzo’s MAC destination address.

The letter now travels back to Romeo via Lorenzo, the same way the first letter traveled from Romeo to Juliet.

2.1.3 Classless Inter-Domain Routing

Class C with a maximum of 254 addresses was too small, and class B with a maximum of 65534 addresses was too large for most users. Resulting in an ineffective usage of the available class B addresses.

Class D contains reserved Multicast addresses. Class E is for experimental purposes. A non-participating Gateway ignores experimental datagrams with these destination addresses.

Since 1993, RFC 1519 has been using Classless Inter-Domain Routing (CIDR) to provide a solution. CIDR overcomes these class boundaries and supports classless address ranges.

With CIDR, you enter the number of bits that designate the IP address range. You represent the IP address range in binary form and count the mask bits that designate the netmask. The mask bits equal the number of bits used for the subnet in a given IP address range.

Example:

| IP address, decimal | Network mask, decimal | IP address, binary |
|---------------------------------|-----------------------|-------------------------------------|
| 149.218.112.1 | 255.255.255.128 | 10010101 11011010 01110000 00000001 |
| 149.218.112.127 | | 10010101 11011010 01110000 01111111 |
| | | ———— 25 mask bits ——— |
| CIDR notation: 149.218.112.0/25 | | |
| | ———— Mask bits | |

The term “supernetting” refers to combing a number of class C address ranges. Supernetting enables you to subdivide class B address ranges to a fine degree.

2.2 Specifying the IP parameters using the CLI

There are several methods you enter the system configuration, either using BOOTP/DHCP, the HiDiscovery protocol, the external memory. You have the option of performing the configuration using the V.24 interface using the CLI.

The device allows you to specify the IP parameters using the HiDiscovery protocol or using the CLI over the V.24 interface.

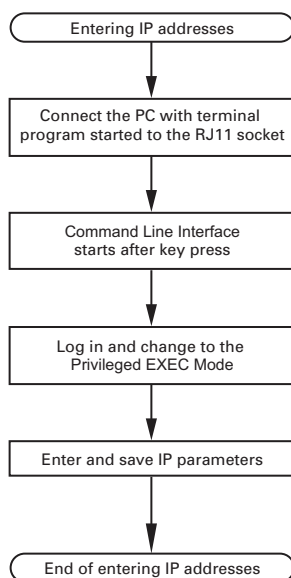

Figure 14: Flow chart for entering IP addresses

Note: If a terminal or PC with terminal emulation is unavailable in the vicinity of the installation location, you can configure the device at your own workstation, then take it to its final installation location.

- Set up a connection to the device.
The start screen appears.

```
NOTE: Enter '?' for Command Help. Command help displays all opt
that are valid for the particular mode.
For the syntax of a particular command form, please
consult the documentation.

! (###) >
```

- Deactivate DHCP.
- Enter the IP parameters.
 - ▶ Local IP address
In the default setting, the local IP address is 0.0.0.0.
 - ▶ Netmask
If you divided your network into subnetworks, and if these are identified with a netmask, then enter the netmask here. In the default setting, the local netmask is 0.0.0.0.
 - ▶ IP address of the Gateway.
This entry is only required if the device and the network management station or TFTP server are located in different subnetworks (see on page 32 “Example of how the netmask is used”). Specify the IP address of the Gateway between the subnetwork with the device and the path to the network management station.
In the default setting, the IP address is 0.0.0.0.

- Save the configuration specified using `copy config running-config nvm`.

| | |
|--|--|
| <pre>enable</pre> | Change to the Privileged EXEC mode. |
| <pre>network protocol none</pre> | Deactivating DHCP. |
| <pre>network parms 10.0.1.23 255.255.255.0</pre> | Assign the device the IP address 10.0.1.23 and the netmask 255.255.255.0. You have the option of also assigning a Gateway address. |
| <pre>copy config running-config nvm</pre> | Save the current settings in the non-volatile memory (nvm) in the “selected” configuration profile. |

After entering the IP parameters, you easily configure the device using the graphical user interface.

2.3 Specifying the IP parameters using HiDiscovery

The HiDiscovery protocol enables you to assign IP parameters to the device using the Ethernet. You easily configure other parameters using the graphical user interface.

Install the HiDiscovery software on your PC. The software is on the product DVD supplied with the device.

- To install it, you start the installation program on the DVD.
- Start the HiDiscovery program.

| ID | MAC Address | Writable | IP Address | Net Mask | Default Gateway | Product | Name |
|----|-------------------|-------------------------------------|----------------|---------------|-----------------|---------|------|
| 1 | 00:80:63:A4:CC:00 | <input checked="" type="checkbox"/> | 10.115.0.76 | 255.255.224.0 | 10.115.0.3 | | |
| 2 | 00:80:63:C0:50:00 | <input type="checkbox"/> | 10.115.0.33 | 255.255.224.0 | 10.115.0.3 | | |
| 3 | 00:80:63:A3:40:00 | <input type="checkbox"/> | 10.115.0.70 | 255.255.224.0 | 10.115.0.3 | | |
| 4 | 00:80:63:9B:14:00 | <input type="checkbox"/> | 10.115.0.17 | 255.255.224.0 | 10.115.0.3 | | |
| 5 | 00:80:63:96:E4:00 | <input type="checkbox"/> | 0.0.0.0 | 0.0.0.0 | 0.0.0.0 | | |
| 6 | 00:80:63:46:00:06 | <input checked="" type="checkbox"/> | 192.168.2.181 | 255.255.255.0 | 192.168.2.1 | | |
| 7 | 00:80:63:A3:40:40 | <input type="checkbox"/> | 10.115.0.59 | 255.255.224.0 | 10.115.0.3 | | |
| 8 | 00:80:63:A4:CC:40 | <input type="checkbox"/> | 10.115.0.81 | 255.255.224.0 | 10.115.0.3 | | |
| 9 | 00:80:63:6E:38:4E | <input checked="" type="checkbox"/> | 192.168.2.174 | 255.255.255.0 | 192.168.2.1 | | |
| 10 | 00:80:63:1B:2A:61 | <input checked="" type="checkbox"/> | 192.168.2.170 | 255.255.255.0 | 192.168.2.1 | | |
| 11 | 00:80:63:A3:40:80 | <input type="checkbox"/> | 10.115.0.66 | 255.255.224.0 | 10.115.0.3 | | |
| 12 | 00:80:63:A4:CC:80 | <input type="checkbox"/> | 10.115.0.80 | 255.255.224.0 | 10.115.0.3 | | |
| 13 | 00:80:63:61:AC:81 | <input checked="" type="checkbox"/> | 192.168.2.176 | 255.255.255.0 | 192.168.2.1 | | |
| 14 | 00:80:63:9B:10:95 | <input type="checkbox"/> | 10.115.0.22 | 255.255.224.0 | 10.115.0.3 | | |
| 15 | 00:80:63:61:AC:AB | <input checked="" type="checkbox"/> | 192.168.2.40 | 255.255.255.0 | 192.168.2.1 | | |
| 16 | 00:80:63:3B:5C:BD | <input checked="" type="checkbox"/> | 192.168.2.178 | 255.255.255.0 | 192.168.2.1 | | |
| 17 | 00:80:63:A3:40:C0 | <input type="checkbox"/> | 10.115.0.72 | 255.255.224.0 | 10.115.0.3 | | |
| 18 | 00:80:63:0F:2C:BE | <input type="checkbox"/> | 10.115.0.40 | 255.255.224.0 | 10.115.0.3 | | |
| 19 | 00:80:63:88:38:EC | <input checked="" type="checkbox"/> | 192.168.110.92 | 255.255.255.0 | 0.0.0.0 | | |
| 20 | 00:80:63:9B:11:00 | <input type="checkbox"/> | 10.115.0.35 | 255.255.224.0 | 10.115.0.3 | | |
| 21 | 00:80:63:A4:CD:00 | <input type="checkbox"/> | 10.115.0.77 | 255.255.224.0 | 10.115.0.3 | | |
| 22 | 00:80:63:99:41:08 | <input type="checkbox"/> | 10.115.0.13 | 255.255.224.0 | 10.115.0.3 | | |
| 23 | 00:80:63:17:35:0B | <input checked="" type="checkbox"/> | 192.168.2.164 | 255.255.255.0 | 192.168.2.1 | | |
| 24 | 00:80:63:44:19:2E | <input checked="" type="checkbox"/> | 10.115.5.130 | 255.255.224.0 | 10.115.0.3 | | |

Figure 15: HiDiscovery

When HiDiscovery is started, HiDiscovery automatically searches the network for those devices which support the HiDiscovery protocol.

HiDiscovery uses the first network interface found for the PC. If your computer has several network cards, you can select the one you desire in the HiDiscovery toolbar.

HiDiscovery displays a line for every device that responds to a HiDiscovery protocol inquiry.

HiDiscovery enables you to identify the devices displayed.

- Select a device line.
- To set the LEDs to flashing for the selected device, click the *Signal* button on the tool bar. To stop the flashing, click the *Signal* button again.
- By double-clicking a line, you open a window in which you specify the device name and the IP parameter.

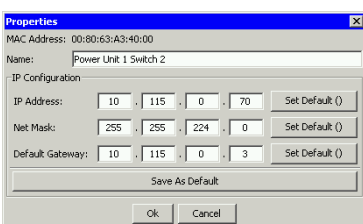

Figure 16: HiDiscovery – assigning IP parameters

Note: For security reasons, disable the HiDiscovery function for the device in the graphical user interface, after you have assigned the IP parameters to the device.

Note: Save the settings so that you will still have the entries after a restart.

2.4 Specifying the IP parameters using the graphical user interface

Perform the following steps:

- Open the *Basic Settings > Network* dialog.

In this dialog you first specify the source from which the device gets its IP parameters after starting. You also define the VLAN in which the device management can be accessed, configure the HiDiscovery access and allocate manual IP parameters.

- In the *Management interface* frame you first specify where the device gets its IP parameters from:
 - ▶ In the *BOOTP* mode, the configuration is using a BOOTP or DHCP server on the basis of the MAC address of the device.
 - ▶ In the *DHCP* mode, the configuration is using a DHCP server on the basis of the MAC address or the name of the device.
 - ▶ In the *Local* mode, the device uses the network parameters from the internal device memory.

Note: When you change the allocation mode of the IP address, the device activates the new mode immediately after you click the button.

- In the *VLAN ID* column you specify the VLAN in which the device management can be accessed over the network.
- Note here that you can only access the device management using ports that are members of the relevant VLAN.

The *MAC address* field displays the MAC address of the device with which you access the device over the network.

- In the *HiDiscovery protocol v1/v2* frame you specify the settings for accessing the device using the HiDiscovery software.
- The HiDiscovery protocol allows you to allocate an IP address to the device on the basis of its MAC address . Activate the HiDiscovery protocol if you want to allocate an IP address to the device from your PC with the HiDiscovery software.
- If required, you enter the IP address, the netmask and the Gateway in the *IP parameter* frame.
- To save the changes temporarily, click the button.

2.5 Specifying the IP parameters using BOOTP

With the `BOOTP` function activated the device sends a boot request message to the BOOTP server. The boot request message contains the Client ID configured in the *Basic Settings > Network* dialog. The BOOTP server enters the Client ID into a database and assigns an IP address. The server answers with a boot reply message. The boot reply message contains the assigned IP address.

2.6 Specifying the IP parameters using DHCP

The DHCP (Dynamic Host Configuration Protocol) is a further development of BOOTP, which it has replaced. The DHCP additionally allows the configuration of a DHCP client using a name instead of using the MAC address.

For the DHCP, this name is known as the “Client Identifier” in accordance with RFC 2131.

The device uses the name entered under sysName in the system group of the MIB II as the Client Identifier. You can change the system name using the graphic user interface (see dialog *Basic Settings > System*), the Command Line Interface or SNMP.

The device sends its system name to the DHCP server. The DHCP server then uses the system name to allocate an IP address as an alternative to the MAC address.

In addition to the IP address, the DHCP server sends

- ▶ the netmask
- ▶ the default Gateway (if available)
- ▶ the TFTP URL of the configuration file (if available).

The device applies the configuration data to the appropriate parameters. When the DHCP Server assigns the IP address, the device permanently saves the configuration data in non-volatile memory..

| Options | Meaning |
|---------|-------------------|
| 1 | Subnet Mask |
| 2 | Time Offset |
| 3 | Router |
| 4 | Time server |
| 12 | Host Name |
| 42 | NTP server |
| 61 | Client Identifier |
| 66 | TFTP Server Name |
| 67 | Bootfile Name |

Table 3: DHCP options which the device requests

The advantage of using DHCP instead of BOOTP is that the DHCP server can restrict the validity of the configuration parameters (“Lease”) to a specific time period (known as dynamic address allocation). Before this period (“Lease Duration”) elapses, the DHCP client can attempt to renew this lease. Alternatively, the client can negotiate a new lease. The DHCP server then allocates a random free address.

To help avoid this, DHCP servers provide the explicit configuration option of assigning a specific client the same IP address based on a unique hardware ID (known as static address allocation).

In the default setting, DHCP is activated. As long as DHCP is activated, the device attempts to obtain an IP address. If it cannot find a DHCP server after restarting, it will not have an IP address. The *Basic Settings > Network* dialog offers you the opportunity to activate or to deactivate DHCP.

Note: When using Industrial HiVision network management, ensure that DHCP always allocates the original IP address to each device.

The appendix contains an example configuration of the BOOTP/DHCP-server.

Example of a DHCP-configuration file:

```
# /etc/dhcpd.conf for DHCP Daemon
#
subnet 10.1.112.0 netmask 255.255.240.0 {
option subnet-mask 255.255.240.0;
```

```
option routers 10.1.112.96;
}
#
# Host berta requests IP configuration
# with her MAC address
#
host berta {
hardware ethernet 00:80:63:08:65:42;
fixed-address 10.1.112.82;
}
#
# Host hugo requests IP configuration
# with his client identifier.
#
host hugo {
#
option dhcp-client-identifier "hugo";
option dhcp-client-identifier 00:68:75:67:6f;
fixed-address 10.1.112.83;
server-name "10.1.112.11";
filename "/agent/config.dat";
}
```

Lines beginning with the # character, contain comments.

The lines preceding the individually listed devices refer to settings that apply to the following device.

The fixed-address line assigns a permanent IP address to the device.

For further information, please refer to the DHCP server manual.

2.7 Management address conflict detection

You assign an IP address to the device using several different methods. This function helps the device detect IP address conflicts on a network after boot up and the device also checks periodically during operation. This function is described in RFC 5227.

When enabled, the device sends an SNMP trap informing you that it detected an IP address conflict.

The following list contains the default settings for this function:

- *Operation*: On
- *Detection mode*: active and passive
- *Send periodic ARP probes*: marked
- *Detection delay [ms]*: 200
- *Release delay [s]*: 15
- *Address protections*: 3
- *Protection interval [ms]*: 200
- *Send trap*: marked

2.7.1 Active and passive detection

Actively checking the network helps prevent the device from connecting to the network with a duplicate IP address. After connecting the device to a network or after configuring the IP address, the device immediately checks whether its IP address exists within the network. To check the network for address conflicts, the device sends 4 ARP probes with the detection delay of 200 ms into the network. If the IP address exists, the device returns to the previous configuration, if possible, and makes another check after the configured release delay time.

When you disable active detection, the device sends 2 gratuitous APR announcements in 2 s intervals. Using the ARP announcements with passive detection enabled, the device polls the network to determine whether there is an address conflict. After resolving an address conflict or after expired release delay time, the device reconnects to the network. Following 10 detected conflicts, if the configured release delay interval is less than 60 s, then the device sets the release delay interval to 60 s.

After the device performs active detection or you disable the active detection function, with passive detection enabled the device listens on the network for other devices using the same IP address. If the device detects a duplicate IP address, it initially defends its address by employing the ACD mechanism in the passive detection mode and sends out gratuitous ARPs. The number of protections that the device sends and the protection interval are configurable. To resolve conflicts, if the remote device remains connected to the network, the network interface of the local device disconnects from the network.

When a DHCP server assigns an IP address to the device, the device returns a DHCP decline message when an address conflict occurs.

The device uses the ARP probe method. This has the following advantages:

- ▶ ARP caches on other devices remain unchanged
- ▶ the method is robust through multiple ARP probe transmissions

3 Access to the device

3.1 Authentication lists

An authentication list contains the policies that the device applies for authentication when a user accesses the device using a specific connection.

The prerequisite for a user's access to the device management is that at least one policy is assigned to the authentication list of the application through which access is performed.

3.1.1 Applications

The device provides an application for each type of connection through which someone accesses the device:

- ▶ Access using CLI via a serial connection: `Console (V.24)`
- ▶ Access using CLI via SSH: `SSH`
- ▶ Access using CLI via Telnet: `Telnet`
- ▶ Access using the graphical user interface: `WebInterface`

The device also provides an application to control the access to the network from connected end devices using port-based access control: `8021x`

3.1.2 Policies

The device allows users to access its management exclusively when they log in with valid login data. The device authenticates the users using the following policies:

- ▶ User management of the device
- ▶ RADIUS

With the port-based access control according to IEEE 802.1X, the device allows connected end devices to access the network if they log in with valid login data. The device authenticates the end devices using the following policies:

- ▶ RADIUS
- ▶ IAS (Integrated Authentication Server)

The device gives you the option of a fall-back solution. For this, you specify more than one policy in the authentication list. If authentication is unsuccessful using the current policy, the device applies the next specified policy.

3.1.3 Managing authentication lists

You manage the authentication lists in the graphical user interface or in the Command Line Interface.

Perform the following steps:

- Open the *Device Security > Authentication List* dialog.
The dialog displays the authentication lists that are set up.

`show authlists` Displays the authentication lists that are set up.

- Deactivate the authentication list for those applications by means of which no access to the device is performed, for example 8021x.

- In the *Active* column of the authentication list `defaultDot1x8021AuthList`, unmark the checkbox.

- To save the changes temporarily, click the button.

`authlists disable defaultDot1x8021AuthList` Deactivates the authentication list `defaultDot1x8021AuthList`.

3.1.4 Adjust the settings

Example:

Set up a separate authentication list for the application `WebInterface` which is by default included in the authentication list `defaultLoginAuthList`. The device forwards authentication requests to a RADIUS server in the network. As a fall-back solution, the device authenticates users using the local user management.

Perform the following steps:

- Create an authentication list `loginGUI`.

- Open the *Device Security > Authentication List* dialog.
- Click the  button.
The dialog displays the *Create* window.
- Enter a meaningful name in the *Name* field.
In this example, enter the name `loginGUI`.
- Click the *Ok* button.
The device adds a new table entry.

```
enable
configure
authlists add loginGUI
```

Change to the Privileged EXEC mode.
Change to the Configuration mode.
Creates the authentication list loginGUI.



Select the policies for the authentication list loginGUI.

- In the **Policy 1** column, select the value radius.
- In the **Policy 2** column, select the value local.
- In the **Policy 3** to **Policy 5** columns, select the value reject to prevent further fall-back.
- In the **Active** column, mark the checkbox.
- To save the changes temporarily, click the button.

```
authlists set-policy loginGUI radius
local reject reject reject
show authlists
authlists enable loginGUI
```

Assigns the policies radius, local and reject to the authentication list loginGUI.
Displays the authentication lists that are set up.
Activates the authentication list loginGUI.

Assign an application to the authentication list loginGUI.

- In the **Device Security > Authentication List** dialog, highlight the authentication list loginGUI.
- Click the  button and then the **Allocate applications** item.
The dialog displays the **Allocate applications** window.
- In the left column, highlight the application WebInterface.
- Click the  button.
The right column now displays the application WebInterface.
- Click the **Ok** button.
The dialog displays the updated settings:
 - The **Dedicated applications** column of authentication list loginGUI displays the application WebInterface.
 - The **Dedicated applications** column of authentication list defaultLoginAuthList does not display the application WebInterface anymore.
- To save the changes temporarily, click the button.

```
show appllists
appllists set-authlist WebInterface
loginGUI
```

Displays the applications and the allocated lists.
Assigns the loginGUI application to the authentication list WebInterface.

3.2 User management

The device allows users to access its management functions when they log in with valid login data. The device authenticates the users either using the local user management or with a RADIUS server in the network. To get the device to use the user management, assign the `local` policy to an authentication list, see the *Device Security > Authentication List* dialog.

In the local user management, you manage the user accounts. One user account is usually allocated to each user.

3.2.1 Access roles

The device allows you to use a role-based authorization model to specifically control the access to the management functions. Users to whom a specific authorization profile is allocated are allowed to use commands and functions from the same authorization profile or a lower one.

The device uses the authorization profiles on all applications with which the management functions can be accessed.

Every user account is linked to an access role that regulates the access to the individual functions of the device. Depending on the planned activity for the respective user, you assign a pre-defined access role to the user. The device differentiates between the following access roles.

| Role | Description | Authorized for the following activities |
|---------------|--|--|
| Administrator | The user is authorized to monitor and administer the device. | All activities with read/write access, including the following activities reserved for an administrator: <ul style="list-style-type: none"> ▶ Add, modify or delete user accounts ▶ Activate, deactivate or unlock user accounts ▶ Change all passwords ▶ Configure password management ▶ Set or change system time ▶ Load files to the device, for example device configurations, certificates or software images ▶ Reset settings and security-related settings to the state on delivery ▶ Configure RADIUS server and authentication lists ▶ Apply CLI scripts ▶ Enable/disable CLI logging and SNMP logging ▶ External memory activation and deactivation ▶ System monitor activation and deactivation ▶ Enable/disable the services for the management access (for example SNMP). ▶ Configure access restrictions to the user interfaces or the CLI based on the IP addresses |
| Operator | The user is authorized to monitor and configure the device - with the exception of security-related settings. | All activities with read/write access, with the exception of the above-named activities, which are reserved for an administrator: |
| Auditor | The user is authorized to monitor the device and to save the log file in the <i>Diagnostics > Report > Audit Trail</i> dialog. | Monitoring activities with read access. |

Table 4: Access roles for user accounts

| Role | Description | Authorized for the following activities |
|--------------|--|---|
| Guest | The user is authorized to monitor the device - with the exception of security-related settings. | Monitoring activities with read access. |
| Unauthorized | No access to the device possible. <ul style="list-style-type: none">▶ As an administrator you assign this access role to temporarily lock a user account.▶ The device assigns this access role to a user account if an error occurs when assigning a different access role. | No activities allowed. |

Table 4: Access roles for user accounts (cont.)

3.2.2 Managing user accounts

You manage the user accounts in the graphical user interface (GUI) or in the CLI.

Perform the following steps:

- Open the *Device Security > User Management* dialog.
The dialog displays the user accounts that are set up.

`show users` Displays the user accounts that are set up.

3.2.3 Default setting

In the state on delivery, the user accounts `admin` and `user` are set up on the device.

| Parameter | Default setting | |
|----------------------|----------------------------|-----------------------|
| User name | <code>admin</code> | <code>user</code> |
| Password | <code>private</code> | <code>public</code> |
| Role | <code>administrator</code> | <code>guest</code> |
| User locked | <code>unmarked</code> | <code>unmarked</code> |
| Policy check | <code>unmarked</code> | <code>unmarked</code> |
| SNMP auth type | <code>hmacmd5</code> | <code>hmacmd5</code> |
| SNMP encryption type | <code>des</code> | <code>des</code> |

Table 5: Default settings for the factory setting user accounts

Change the password for the `admin` user account before making the device available in the network.

3.2.4 Changing default passwords

To prevent undesired access, change the password of the default user accounts.

Perform the following steps:

- Change the passwords for the `admin` and `user` user accounts.
 - Open the *Device Security > User Management* dialog. The dialog displays the user accounts that are set up.
 - To obtain a higher level of complexity for the password, mark the checkbox in the *Policy check* column. Before saving it, the device checks the password according to the policy specified in the *Password policy* frame.

Note: The password check may lead to a message in the *Security status* frame in the *Basic Settings > System* dialog. You specify the settings that cause this message in the *Basic Settings > System* dialog.
 - Click the row of the relevant user account in the *Password* field. Enter a password of at least 6 characters.
 - Up to 64 alphanumeric characters are allowed.
 - ▶ The device differentiates between upper and lower case.
 - ▶ The minimum length of the password is specified in the *Configuration* frame. The device always checks the minimum length of the password.
 - To save the changes temporarily, click the button.

```
enable
configure
users password-policy-check <user>
enable
```

Change to the Privileged EXEC mode.

Change to the Configuration mode.

Activates the checking of the password for the `<user>` user account based on the specified policy. In this way, you obtain a higher level of complexity for the password.

Note: The password check may lead to a message when you display the security status (`show security-status all`). You specify the settings that cause this message with the command `security-status monitor pwd-policy-inactive`.

```
users password <user> SECRET
```

Specifies the password `<user>` for the `SECRET` user account. Enter at least 6 characters.

```
save
```

Save the settings in the non-volatile memory (nvm) in the "selected" configuration profile.



3.2.5 Setting up a new user account

Allocate a separate user account to each user that accesses the device management. In this way you can specifically control the authorizations for the access.

In the following example, we will set up the user account for a `USER` user with the role `operator`. Users with the `operator` role are authorized to monitor and configure the device - with the exception of security-related settings.

Perform the following steps:

- Create a new user account.

- Open the *Device Security > User Management* dialog.
- Click the  button.
The dialog displays the *Create* window.
- Enter the name in the *User name* field.
In this example, we give the user account the name `USER`.
- Click the *Ok* button.
- To obtain a higher level of complexity for the password, mark the checkbox in the *Policy check* column.
Before saving it, the device checks the password according to the policy specified in the *Password policy* frame.
- In the *Password* field, enter a password of at least 6 characters.
Up to 64 alphanumeric characters are allowed.
 - ▶ The device differentiates between upper and lower case.
 - ▶ The minimum length of the password is specified in the *Configuration* frame. The device always checks the minimum length of the password.
- In the *Role* column, select the user role.
In this example, we select the value `operator`.
- To activate the user account, mark the checkbox in the *Active* column.
- To save the changes temporarily, click the  button.
The dialog displays the user accounts that are set up.

| | |
|--|---|
| <code>enable</code> | Change to the Privileged EXEC mode. |
| <code>configure</code> | Change to the Configuration mode. |
| <code>users add USER</code> | Creates the <code>USER</code> user account. |
| <code>users password-policy-check USER enable</code> | Activates the checking of the password for the <code>USER</code> user account based on the specified policy. In this way, you obtain a higher level of complexity for the password. |
| <code>users password USER SECRET</code> | Specifies the password <code>USER</code> for the <code>SECRET</code> user account. Enter at least 6 characters. |
| <code>users access-role USER operator</code> | Assign the user role <code>operator</code> to the user account <code>USER</code> . |
| <code>users enable USER</code> | Activates the <code>USER</code> user account. |
| <code>show users</code> | Displays the user accounts that are set up. |
| <code>save</code> | Save the settings in the non-volatile memory (<code>nvm</code>) in the “selected” configuration profile. |

Note: Remember to allocate the password when you are setting up a new user account in the CLI.

3.2.6 Deactivating the user account

After a user account is deactivated, the device denies the related user access to the management functions. In contrast to completely deleting it, deactivating a user account allows you to keep the settings and reuse them in the future.

Perform the following steps:

- To keep the user account settings and reuse them in the future, you temporarily deactivate the user account.

- Open the *Device Security > User Management* dialog.
The dialog displays the user accounts that are set up.

- In the row for the relevant user account, unmark the checkbox in the *Active* column.

- To save the changes temporarily, click the button.

```
enable
configure
users disable <user>
show users
save
```

Change to the Privileged EXEC mode.

Change to the Configuration mode.

To disable user account.

Displays the user accounts that are set up.

Save the settings in the non-volatile memory (NVM) in the "selected" configuration profile.

- To permanently deactivate the user account settings, you delete the user account.

- Highlight the row for the relevant user account.

- Click the  button.

```
users delete <user>
show users
save
```

Deletes the <user> user account.

Displays the user accounts that are set up.

Save the settings in the non-volatile memory (NVM) in the "selected" configuration profile.

3.2.7 Adjusting policies for passwords

The device allows you to check whether the passwords for the user accounts adhere to the specified policy. You obtain a higher level of complexity for the passwords when they adhere to the policy.

The user management of the device allows you to activate or deactivate the check separately in each user account. When the check is activated, the device accepts a changed password only if it fulfills the requirements of the policy.

In the default settings, practical values for the policy are set up on the device. You have the option of adjusting the policy to meet your requirements.

Perform the following steps:

- Adjust the policy for passwords to meet your requirements.

- Open the *Device Security > User Management* dialog.

In the *Configuration* frame you specify the number user login attempts before the device locks out the user. You also specify the minimum number of characters that defines a password.

- Specify the values to meet your requirements.
 - ▶ You specify the number of times that a user attempts to log on to the device in the *Login attempts* field. The field allows you to define this value in the range 0..5. In the above example, the value 0 deactivates the function.
 - ▶ The *Min. password length* field allows values in the range 1..64.

The dialog displays the policy set up in the *Password policy* frame.

- Adjust the values to meet your requirements.
 - ▶ Values in the range 1 through 16 are allowed. The value 0 deactivates the relevant policy.

To apply the entries specified in the *Configuration* and *Password policy* frames, mark the checkbox in the *Policy check* column for a particular user.

- To save the changes temporarily, click the button.

| | |
|---------------------------------|---|
| enable | Change to the Privileged EXEC mode. |
| configure | Change to the Configuration mode. |
| passwords min-length 6 | Specifies the policy for the minimum length of the password. |
| passwords min-lowercase-chars 1 | Specifies the policy for the minimum number of lower-case letters in the password. |
| passwords min-numeric-chars 1 | Specifies the policy for the minimum number of digits in the password. |
| passwords min-special-chars 1 | Specifies the policy for the minimum number of special characters in the password. |
| passwords min-uppercase-chars 1 | Specifies the policy for the minimum number of upper-case letters in the password. |
| show passwords | Displays the policies that are set up. |
| save | Save the settings in the non-volatile memory (nvram) in the "selected" configuration profile. |

3.3 SNMP access

The SNMP protocol allows you to work with a network management system to monitor the device over the network and change its settings.

3.3.1 SNMPv1/v2 access

Using SNMPv1 or SNMPv2 the network management system and the device communicate unencrypted. Every SNMP packet contains the community name in plain text and the IP address of the sender.

The community names `public` for read accesses and `private` for write accesses are preset in the device. If SNMPv1/v2 is enabled, the device allows anyone who knows the community name to access the device.

Make the following basic provisions to make undesired access to the device more difficult:

- Change the default community names in the device.
 - Treat the community names with discretion.
 - Anyone who knows the community name for write access, has the ability to change the settings of the device.
- Specify a different community name for read/write access than for read access.
- Use SNMPv1 or SNMPv2 only in environments protected from eavesdropping. The protocols do not use encryption.
- We recommend using SNMPv3 and disabling the access using SNMPv1 and SNMPv2 in the device.

3.3.2 SNMPv3 access

Using SNMPv3 the network management system and the device communicate encrypted. The network management system authenticates itself with the device using the credentials of a user. The prerequisite for the SNMPv3 access is that in the network management system uses the same settings that are defined in the device.

The device allows you to specify the *SNMP auth type* and *SNMP encryption type* parameters individually in each user account.

When you set up a new user account on the device, the parameters are preset so that the network management system Industrial HiVision reaches the device immediately.

The user accounts set up in the device use the same passwords in the graphical user interface, in the command line interface (CLI), and for SNMPv3.

To adapt the SNMPv3 parameters of the user account settings to the settings in your network management system, perform the following steps:

- Open the *Device Security > User Management* dialog.
The dialog displays the user accounts that are set up.
- Click the row of the relevant user account in the *SNMP auth type* field. Select the desired setting.
- Click the row of the relevant user account in the *SNMP encryption type* field. Select the desired setting.
- To save the changes temporarily, click the button.

| | |
|---|--|
| enable | Change to the Privileged EXEC mode. |
| configure | Change to the Configuration mode. |
| users snmpv3 authentication <user> md5 sha1 | Assigning the HMAC-MD5 or HMACSHA protocol for authentication requests to the <user> user account. |
| users snmpv3 encryption <user> des aesfb128 none | Assigns the DES or AES-128 algorithm to the <user> user account. With this algorithm, the device encrypts authentication requests. The value <code>none</code> removes the encryption. |
| show users | Display the user accounts that have been configured. |
| save | Save the settings in the non-volatile memory (nvm) in the "selected" configuration profile. |

3.4 Service Shell

When you need assistance with your device, then the service personnel use the Service Shell to monitor internal conditions, for example switch or CPU registers.

The Service Shell is for service purposes exclusively. This function allows the access on internal functions of the device. In no case, execute internal functions without service technician instructions. Executing internal functions such as deleting the content of the NVM (non-volatile memory) possibly leads to inoperability of your device.

■ Start the Service Shell

Perform the following steps:

- To switch from the User Exec mode to the Privileged Exec mode, enter `enable`, or enter `en` and a Space character, and press the <Enter> key.
- To get a list of the commands available in this mode, press the <?> key.

```
!(RED) >enable

!(RED) #?
clear          Clear several items.
configure     Enter into global config mode.
copy          Copy different kinds of items.
debug         Service functions to find configuration errors.
exit          Exit from current mode.
help          Display help for various special keys.
history       Show a list of previously run commands.
login         Set login parameters.
logout        Exit this session.
network       Modify network parameters.
ping          Send ICMP echo packets to a specified
              IP address.
profile       Activate or delete configuration profiles.
reboot        Reset the device (cold start).
save          Save configuration.
serviceshell Enter system mode.
set           Set device parameters.
show          Display device options and settings.
traceroute    Trace route to a specified host.

!(RED) #serviceshell

-> exit
Au revoir!

!* (RED) #
```

-
- To start the Service Shell, enter `serviceshell` in the privileged exec mode, or enter `ser` and a Space character, and press the <Enter> key.

To prevent configuration inconsistencies, log out from the Service Shell before any other user starts uploading a new configuration to the device.

- To end the Service Shell, enter `exit` and then press the <Enter> key.

Note: When the Service Shell is active, the timeout of the Command Line Interface is inactive.

■ Deactivate the Service Shell permanently

If you do not need the Service Shell, the device allows you to disable the function. In this case you still have the option to configure the device. Though, the service technician has no possibilities to access internal functions of your device to call up additional required information.

Note: When you deactivate the Service Shell, then you are still able to configure the device, but you limit the service personnel to system diagnostics. The deactivation is irreversible, the Service Shell remains permanently deactivated. **In order to reactivate the Service Shell, the device requires disassembly by the manufacturer.**

Perform the following steps:

- To display the Service Shell, enter `serviceshell`, or enter `ser` and a Space character, and press the <Enter> key.
- This process is irreversible!
To permanently deactivate the Service Shell, enter `deactivate`, or enter `d` and a Space character, and press the <Enter> key.

```
!(RED) >enable

!(RED) #serviceshell?
[deactivate]          Disable the service shell access permanently
                      (Cannot be undone).
<cr>                  Press Enter to execute the command.

!(RED) #serviceshell deactivate
```

4 Managing configuration profiles

If you change the settings of the device during operation, the device stores the changes in its memory (RAM). After a reboot the settings are lost.

In order to keep the changes after a reboot, the device offers the possibility of saving additional settings in a configuration profile in the non-volatile memory (NVM). In order to make it possible to quickly switch to other settings, the non-volatile memory offers storage space for multiple configuration profiles.

If an external memory is connected, the device generates a copy of the configuration profile on the external memory automatically. This function can be deactivated.

4.1 Detecting changed settings

Changes made to settings during operation are stored by the device in its memory (RAM). The configuration profile in non-volatile memory (NVM) remains unchanged until you explicitly save it. Until then, the configuration profiles in memory and non-volatile memory differ.

This device helps you recognize changed settings. If the configuration profile in the memory (RAM) differs from the "selected" configuration profile in the non-volatile memory (NVM), you can recognize the difference based on the following criteria:

The status bar at the top of the menu displays the icon . If the configuration profiles match, the icon is hidden.

In the *Basic Settings > Load/Save* dialog, the checkbox in the *Information* frame is unmarked. If the configuration profiles match, the checkbox is marked.

```
show config status
Configuration Storage sync State
-----
running-config to NV.....out of sync
...
```

If the copy in the external memory differs from the configuration profile in the non-volatile memory, you see the difference based on the following criteria:

In the *Basic Settings > Load/Save* dialog, the checkbox in the *Information* frame is unmarked. If the configuration profiles match, the checkbox is marked.

```
show config status
Configuration Storage sync State
-----
...
NV to ACA.....out of sync
...
```

4.2 Saving the settings

4.2.1 Saving the configuration profile in the device

If you change the settings of the device during operation, the device stores the changes in its memory (RAM). In order to keep the changes after a reboot, save the configuration profile in non-volatile memory (NVM).

■ Saving a configuration profile

The device always stores the settings in the "selected" configuration profile in non-volatile memory (NVM).

Perform the following steps:

- Open the *Basic Settings* > *Load/Save* dialog.
- Verify that the desired configuration profile is "Selected".
You can recognize the "selected" configuration profile by the fact that the checkbox in the *Selected* column is marked.
- Click the button.

`show config profiles nvm`

Displays the configuration profiles contained in non-volatile memory (nvm).

`enable`

Change to the Privileged EXEC mode.

`save`

Save the settings in the non-volatile memory (nvm) in the "selected" configuration profile.

■ Copying settings to a configuration profile

The device allows you to store the settings saved in memory (RAM) in a configuration profile other than the "selected" configuration profile. In this way you create a new configuration profile in non-volatile memory (NVM) or overwrite an existing one.

Perform the following steps:

- Open the *Basic Settings* > *Load/Save* dialog.
- Click the  button and then the *Save As...* item.
The dialog displays the *Save As...* window.
- In the *Name* field, change the name of the configuration profile. If you keep the proposed name, the device will overwrite an existing configuration profile of the same name.
- Click the *Ok* button.

The new configuration profile is designated as "Selected".

`show config profiles nvm`

Displays the configuration profiles contained in non-volatile memory (nvm).



```
enable
copy config running-config nvmm profile
<string>
```

Change to the Privileged EXEC mode.
Save the current settings in the configuration profile named `<string>` in non-volatile memory (nvmm). If present, the device overwrites a configuration profile of the same name. The new configuration profile is designated as "Selected".

■ Selecting a configuration profile

If the non-volatile memory (NVM) contains several configuration profiles, you have the option to select any configuration profile there. The device always stores the settings in the "selected" configuration profile. Upon reboot, the device loads the settings of the "selected" configuration profile into memory (RAM).

Perform the following steps:

- Open the *Basic Settings > Load/Save* dialog.
The table displays the configuration profiles present in the device. You can recognize the "selected" configuration profile by the fact that the checkbox in the *Selected* column is marked.
- In the table, select the entry of the desired configuration profile stored in non-volatile memory (NVM).
- Click the  button and then the *Select* item.

In the *Selected* column, the checkbox of the configuration profile is now marked.

```
enable
show config profiles nvmm

configure
config profile select nvmm 1

save
```

Change to the Privileged EXEC mode.
Displays the configuration profiles contained in non-volatile memory (nvmm).
Change to the Configuration mode.
Identifier of the configuration profile.
Take note of the adjacent name of the configuration profile.
Save the settings in the non-volatile memory (nvmm) in the "selected" configuration profile.

4.2.2 Backup the configuration profile on a remote server

The device allows you to automatically backup the configuration profile to a remote server. The prerequisite is that you activate the function before you save the configuration profile.

After you save the configuration profile in the non-volatile memory (NVM), the device sends a copy to the specified URL.

Perform the following steps:

- Open the *Basic Settings > Load/Save* dialog.
The following steps you perform in the *Backup config on a remote server when saving* frame.
- In the *URL* field, specify the server as well as path and file name of the backed up configuration profile.
- Click the *Set credentials* button.
The dialog displays the *Credentials* window.
- Enter the credentials needed to authenticate on the remote server.

- In the *Operation* option list, enable the function.
- To save the changes temporarily, click the button.

```
enable
show config remote-backup
configure
config remote-backup destination
config remote-backup username
config remote-backup password
config remote-backup operation
```

Change to the Privileged EXEC mode.
Check status of the function.
Change to the Configuration mode.
Enter the destination URL for the configuration profile backup.
Enter the user name to authenticate on the remote server.
Enter the password to authenticate on the remote server.
Enable the function.

In case the transfer to the remote server is unsuccessful, the device logs this event in the log file (System Log).

4.2.3 Saving the configuration profile in external memory

When you save a configuration profile, the device automatically creates a copy in external memory when the external memory is connected. In the default setting, the function is enabled. You have the following option of enabling or disabling this function.

Perform the following steps:

- Open the *Basic Settings > External Memory* dialog.
- In order to cause the device to automatically generate a copy in external memory during the saving process, select the checkbox in the *Backup config when saving* column.
- To disable the function, remove the checkmark from the checkbox in the *Backup config when saving* column.
- To save the changes temporarily, click the button.

```
enable
configure
config envm config-save usb

no config envm config-save usb

save
```

Change to the Privileged EXEC mode.
Change to the Configuration mode.
Enable the function. When you save a configuration profile, the device creates a copy in the external memory.
usb = External USB memory
Disable the function. The device does not create a copy in the external memory.
usb = External USB memory
Save the settings in the non-volatile memory (nvram) in the “selected” configuration profile.

4.2.4 Exporting a configuration profile

The device offers you the option of saving a configuration profile to a server as an XML file. If you use the graphical user interface, you have the option to save the XML file directly to your PC.

Prerequisite:

- ▶ To save the file on a server, you need a configured server on the network.
- ▶ To save the file to an SCP or SFTP server, you also need the username and password for accessing this server.

Perform the following steps:

- Open the *Basic Settings > Load/Save* dialog.
- In the table, select the entry of the desired configuration profile.

To export the configuration profile to your PC, perform the following steps:

- Click the link in the *Profile name* column.
- Select the storage location and specify the file name.
- Click the *Ok* button.

The configuration profile is now saved as an XML file in the specified location.

To export the configuration profile to a remote server, perform the following steps:

- Click the  button and then the *Export...* item.
The dialog displays the *Export...* window.
- In the *URL* field, specify the file URL on the remote server:
 - ▶ To save the file on an FTP server, specify the URL for the file in the following form:
`ftp://<user>:<password>@<IP address>:<port>/<file name>`
 - ▶ To save the file on a TFTP server, specify the URL for the file in the following form:
`tftp://<IP address>/<path>/<file name>`
 - ▶ To save the file on an SCP or SFTP server, specify the URL for the file in one of the following forms:
`scp:// or sftp://<user>:<password>@<IP address>/<path>/<file name>`
`scp:// or sftp://<IP address>/<path>/<file name>`When you click the *Ok* button, the device displays the *Credentials* window. There you enter *User name* and *Password*, to log on to the server.
- Click the *Ok* button.
The configuration profile is now saved as an XML file in the specified location.

| | |
|---|---|
| <code>show config profiles nvm</code> | Displays the configuration profiles contained in non-volatile memory (<i>nvm</i>). |
| <code>enable</code> | Change to the Privileged EXEC mode. |
| <code>copy config running-config remote tftp://<IP_address>/ <path>/<file_name></code> | Save the current settings on a TFTP server. |
| <code>copy config nvm remote sftp://<user_name>:<password>@<IP_address>/<path>/<file_name></code> | Saves the selected configuration profile in the non-volatile memory (<i>nvm</i>) on a SFTP server. |
| <code>copy config nvm profile config3 remote tftp://<IP_address>/ <path>/<file_name></code> | Save the configuration profile <code>config3</code> in the non-volatile memory (<i>nvm</i>) on a TFTP server. |
| <code>copy config nvm profile config3 remote ftp://<IP_address>:<port>/<path>/<file_name></code> | Save the configuration profile <code>config3</code> in the non-volatile memory (<i>nvm</i>) on an FTP server. |

4.3 Loading settings

Through loading of settings, the device allows you to quickly switch to other settings if required.

4.3.1 Activating a configuration profile

The non-volatile memory of the device can accommodate several configuration profiles. If you activate a configuration profile stored there, you change the settings on the device on the fly without rebooting.

Perform the following steps:

- Open the *Basic Settings > Load/Save* dialog.
- In the table, select the entry of the desired configuration profile.
- Click the  button and then the *Activate* item.

The device copies the settings to memory (RAM) and disconnects from the graphical user interface. The device immediately uses the settings of the configuration profile on the fly.

- Reload the graphical user interface.
- Log in again.

In the *Selected* column, the checkbox of the configuration profile that was just activated is marked.

```
show config profiles nvm
```

Displays the configuration profiles contained in non-volatile memory (nvm).

```
enable
```

Change to the Privileged EXEC mode.

```
copy config nvm profile config3 running-  
config
```

Activate the settings of the configuration profile `config3` in the non-volatile memory (nvm).

The device copies the settings into the volatile memory and disconnects the CLI connection. The device immediately uses the settings of the configuration profile `config3` on the fly.

4.3.2 Loading the configuration profile from the external memory

If an external memory is connected, the device loads a configuration profile from the external memory upon restart automatically. The device allows you to save these settings in a configuration profile in non-volatile memory.

If the external memory contains the configuration profile of an identical device, this allows you to transfer the settings from one device to another.

Perform the following steps:

- Verify that the device loads a configuration profile from the external memory upon restart.

In the default setting, the function is enabled. If the function is disabled, enable it again as follows:

- Open the *Basic Settings > External Memory* dialog.
- In the *Config priority* column, select the value *first*.
- To save the changes temporarily, click the button.

| | | | | |
|-------------------------------------|--|-------------|-------------|------------------|
| enable | Change to the Privileged EXEC mode. | | | |
| configure | Change to the Configuration mode. | | | |
| config envm load-priority usb first | Enable the function. Upon reboot, the device loads a configuration profile from the external memory. usb = External USB memory | | | |
| show config envm settings | Displays the settings of the external memory (envm). | | | |
| Type | Status | Auto Update | Save Config | Config Load Prio |
| ----- | | | | |
| save | Save the settings in a configuration profile in the non-volatile memory (NVM) of the device | | | |

The device allows you via CLI to copy the settings from the external memory directly into non-volatile memory.

| | |
|--------------------------------------|---|
| show config profiles nvm | Displays the configuration profiles contained in non-volatile memory (nvm). |
| enable | Change to the Privileged EXEC mode. |
| copy config envm profile config3 nvm | Copy the configuration profile <i>config3</i> from the external memory (envm) to the non-volatile memory (nvm). |

4.3.3 Importing a configuration profile

The device allows you to import from a server a configuration profile saved as an XML file. If you use the graphical user interface, you have the option to import the XML file directly from your PC.

Prerequisite:

- ▶ To save the file on a server, you need a configured server on the network.
- ▶ To save the file to an SCP or SFTP server, you also need the username and password for accessing this server.

Perform the following steps:

- Open the *Basic Settings > Load/Save* dialog.
- Click the  button and then the *Import...* item.
The dialog displays the *Import...* window.
- In the *Select source* drop-down list, select from where the device imports the configuration profile.
 - ▶ PC/URL
The device imports the configuration profile from the local PC or from a remote server.
 - ▶ External memory
The device imports the configuration profile from the external memory.

To import the configuration profile from the local PC or from a remote server, perform the following steps:

- Import the configuration profile:
 - If the file is located on an FTP server, specify the URL for the file in the following form:
`ftp://<user>:<password>@<IP address>:<port>/<file name>`
 - If the file is located on a TFTP server, specify the URL for the file in the following form:
`tftp://<IP address>/<path>/<file name>`
 - If the file is located on an SCP or SFTP server, specify the URL for the file in one of the following forms:
`scp://` or `sftp://<IP address>/<path>/<file name>`
When you click the *Start* button, the device displays the *Credentials* window. There you enter *User name* and *Password*, to log on to the server.
`scp://` or `sftp://<user>:<password>@<IP address>/<path>/<file name>`
- In the *Destination* frame, specify where the device saves the imported configuration profile:
 - In the *Profile name* field, specify the name under which the device saves the configuration profile.
 - In the *Storage type* field, specify the storage location for the configuration profile.
- Click the *Ok* button.
The device copies the configuration profile into the specified memory.
If you specified the value `ram` in the *Destination* frame, the device disconnects the graphical user interface and uses the settings immediately on the fly.

To import the configuration profile from the external memory, perform the following steps:

- In the *Import profile from external memory* frame, *Profile name* drop-down list, select the name of the configuration profile to be imported.
The prerequisite is that the external memory contains an exported configuration profile.
- In the *Destination* frame, specify where the device saves the imported configuration profile:
 - In the *Profile name* field, specify the name under which the device saves the configuration profile.
- Click the *Ok* button.
The device copies the configuration profile into the non-volatile memory (NVM) of the device.
If you specified the value `ram` in the *Destination* frame, the device disconnects the graphical user interface and uses the settings immediately on the fly.

```
enable
copy config remote ftp://
<IP_address>:<port>/<path>/<file_name>
running-config

copy config remote tftp://<IP_address>/
<path>/<file_name> running-config

copy config remote sftp://
<user name>:<password>@<IP_address>/
<path>/<file_name> running-config

copy config remote ftp://
<IP_address>:<port>/<path>/<file_name>
nvm profile config3
copy config remote tftp://<IP_address>/
<path>/<file_name> nvm profile config3
```

Change to the Privileged EXEC mode.

Import and activate the settings of a configuration profile saved on an FTP server.

The device copies the settings into the volatile memory and disconnects the CLI connection. The device immediately uses the settings of the imported configuration profile on the fly.

Import and activate the settings of a configuration profile saved on a TFTP server.

The device copies the settings into the volatile memory and disconnects the CLI connection. The device immediately uses the settings of the imported configuration profile on the fly.

Import and activate the settings of a configuration profile saved on a SFTP server.

The device copies the settings into the volatile memory and disconnects the CLI connection. The device immediately uses the settings of the imported configuration profile on the fly.

Import the settings of a configuration profile saved on an FTP server and save the settings in the configuration profile `config3` in the non-volatile memory (`nvm`).

Import the settings of a configuration profile saved on a TFTP server and save the settings in the configuration profile `config3` in the non-volatile memory (`nvm`).

4.4 Reset the device to the factory defaults

If you reset the settings in the device to the delivery state, the device deletes the configuration profiles in the volatile memory and in the non-volatile memory.

If an external memory is connected, the device also deletes the configuration profiles saved on the external memory.

The device then reboots and loads the factory settings.

4.4.1 Using the graphical user interface or CLI

Perform the following steps:

- Open the *Basic Settings > Load/Save* dialog.
- Click the  button, then *Back to factory...*
The dialog displays a warning message.
- Click the *Ok* button.

The device deletes the configuration profiles in the memory (RAM) and in the non-volatile memory (NVM).

If an external memory is connected, the device also deletes the configuration profiles saved on the external memory.

After a brief period, the device restarts and loads the delivery settings.

```
enable  
clear factory
```

Change to the Privileged EXEC mode.

Deletes the configuration profiles from the non-volatile memory and from the external memory.

If an external memory is connected, the device also deletes the configuration profiles saved on the external memory.

After a brief period, the device restarts and loads the delivery settings.

4.4.2 Using the System Monitor

Prerequisite:

Your PC is connected with the V.24 connection of the device using a terminal cable.

Perform the following steps:

- Restart the device.
- To switch to the System Monitor, press the <1> key within 3 seconds when prompted during reboot.
The device loads the System Monitor.
- To switch from the main menu to the `Manage configurations` menu, press the <4> key.

To execute the `Clear configs and boot params` command, press the <1> key.

To load the factory settings, press the <Enter> key.

The device deletes the configuration profiles in the memory (RAM) and in the non-volatile memory (NVM).

If an external memory is connected, the device also deletes the configuration profiles saved on the external memory.

To switch to the main menu, press the <q> key.

To reboot the device with factory settings, press the <q> key.

5 Loading software updates

Hirschmann is continually working on improving and developing their software. Check regularly whether there is an updated version of the software that provides you with additional benefits. You find information and software downloads on the Hirschmann product pages on the Internet at www.hirschmann.com.

The device gives you the following options for updating the device software:

- ▶ [Software update from the PC](#)
- ▶ [Software update from a server](#)
- ▶ [Software update from the external memory](#)
- ▶ [Loading an older software](#)

Note: The device settings are kept after updating the device software.

You see the version of the installed device software on the Login page of the graphical user interface. If you are already logged in, perform the following steps to display the version of the installed software.

- Open the *Basic Settings > Software* dialog.

The field *Running version* displays the version number and creation date of the device software that the device loaded during the last restart and is currently running.

```
enable
show system info
```

Change to the Privileged EXEC mode.

Displays the system information such as the version number and creation date of the device software that the device loaded during the last restart and is currently running.

5.1 Software update from the PC

The prerequisite is that the image file of the device software is saved on a data carrier which is accessible from your PC.

Perform the following steps:

- Navigate to the folder where the image file of the device software is saved.
- Open the *Basic Settings* > *Software* dialog.
- Drag and drop the image file in the  area. Alternatively click in the area to select the file.
- To start the update procedure, click the *Start* button.
As soon as the update procedure is completed successfully, the device displays an information that the software is successfully updated.
Upon restart, the device loads the installed device software.

5.2 Software update from a server

To update the software using SFTP or SCP you need a server on which the image file of the device software is saved.

To update the software using TFTP, SFTP or SCP you need a server on which the image file of the device software is saved.

Perform the following steps:

- Open the *Basic Settings > Software* dialog.
- In the *Software update* frame, *URL* field, enter the URL for the image file in the following form:
 - ▶ When the image file is saved on an FTP server:
ftp://<IP_address>:<port>/<path>/<image_file_name>.bin
 - ▶ When the image file is saved on a TFTP server:
tftp://<IP_address>/<path>/<image_file_name>.bin
 - ▶ When the image file is saved on a SCP or SFTP server:
scp:// or sftp://<IP_address>/<path>/<image_file_name>.bin
scp:// or sftp://<username>:<password>@<IP_address>/<path>/<image_file_name>.bin

If you enter the URL without the user name and password, the device displays the *Credentials* window. There you enter credentials needed to log on to the server.
- To start the update procedure, click the *Start* button.
The device copies the currently running device software into the backup memory. As soon as the update procedure is completed successfully, the device displays an information that the software is successfully updated.
Upon restart, the device loads the installed device software.

enable

```
copy firmware remote tftp://10.0.1.159/
product.bin system
```

Change to the Privileged EXEC mode.

Transfer the `product.bin` file from the TFTP server with the IP address 10.0.1.159 to the device.

5.3 Software update from the external memory

5.3.1 Manually—initiated by the administrator

The device allows you to update the device software with just a few mouse clicks. The prerequisite is that the image file of the device software is located in the external memory.

Perform the following steps:

- Open the *Basic Settings* > *Software* dialog.
- In the table, mark the row which displays the name of the desired image file on the external memory.
- Right-click to display the context menu.
- To start the update procedure, click in the context menu the *Update* item.

The device copies the currently running device software into the backup memory. As soon as the update procedure is completed successfully, the device displays an information that the software is successfully updated. Upon restart, the device loads the installed device software.

5.3.2 Automatically—initiated by the device

During a restart the device updates the device software automatically when the following files are located in the external memory:

- ▶ the image file of the device software
- ▶ a text file `startup.txt` with the content `autoUpdate=<Image_file_name>.bin`

The prerequisite is that in the *Basic Settings* > *External Memory* dialog, you mark the checkbox in the *Software auto update* column. This is the default setting on the device.

Perform the following steps:

- Copy the image file of the new device software into the main directory of the external memory. Use an image file suitable for the device exclusively.
- Create a text file `startup.txt` in the main directory of the external memory.
- Open the `startup.txt` file in the text editor and add the following line:
`autoUpdate=<Image_file_name>.bin`
- Install the external memory on the device.
- Restart the device.

During the booting process, the device checks automatically the following criteria:

- Is an external memory connected?
- Is a `startup.txt` file in the main directory of the external memory?

- Does the image file exist which is specified in the `startup.txt` file?
- Is the software version of the image file more recent than the software currently running on the device?

If the criteria are fulfilled, the device starts the update procedure.

The device copies the currently running device software into the backup memory.

As soon as the update procedure is completed successfully, the device reboots automatically and loads the new software version.

Check the result of the update procedure. The log file in the *Diagnostics > Report > System Log* dialog contains one of the following messages:

- ▶ `S_watson_AUTOMATIC_SWUPDATE_SUCCESS`
Software update completed successfully
- ▶ `S_watson_AUTOMATIC_SWUPDATE_ABORTED`
Software update aborted
- ▶ `S_watson_AUTOMATIC_SWUPDATE_ABORTED_WRONG_FILE`
Software update aborted due to wrong image file
- ▶ `S_watson_AUTOMATIC_SWUPDATE_ABORTED_SAVING_FILE`
Software update aborted due to failed saving of the image file to the device

5.4 Loading an older software

The device allows you to replace the device software with an older version. The basic settings on the device are kept after replacing the device software.

Note: The settings for functions which are available in the newer device software version exclusively are lost.

6 Configuring the ports

The following port configuration functions are available.

- ▶ Enabling/disabling the port
- ▶ Selecting the operating mode

6.1 Enabling/disabling the port

In the default setting, every port is enabled. For a higher level of access security, disable the ports for which you are not making any connection.

Perform the following steps:

- Open the *Basic Settings > Port* dialog, *Configuration* tab.
- To enable a port, mark the checkbox in the *Port on* column.
- To disable a port, unmark the checkbox in the *Port on* column.
- To save the changes temporarily, click the button.

```
enable
configure
interface 1/1
no shutdown
```

```
Change to the Privileged EXEC mode.
Change to the Configuration mode.
Change to the interface configuration mode of interface 1/1.
Enable the interface.
```

6.2 Selecting the operating mode

In the default setting, the ports are set to *Automatic configuration* operating mode.

Note: The active automatic configuration has priority over the manual configuration.

Perform the following steps:

- Open the *Basic Settings > Port* dialog, *Configuration* tab.
- If the device connected to this port requires a fixed setting:
 - Deactivate the function. Unmark the checkbox in the *Automatic configuration* column.
 - In the *Manual configuration* column, enter the desired operating mode (transmission rate, duplex mode).
- To save the changes temporarily, click the button.

```
enable
configure
interface 1/1
no auto-negotiate
speed 10 full
```

Change to the Privileged EXEC mode.
Change to the Configuration mode.
Change to the interface configuration mode of interface 1/1.
Disable the automatic configuration mode.
Port speed 10 MBit/s, full duplex

7 Assistance in the protection from unauthorized access

The device offers functions that help you protect the device against unauthorized access.

After you set up the device, carry out the following steps in order to reduce the risk of unauthorized access to the device.

- ▶ Changing the SNMPv1/v2 community
- ▶ Disabling SNMPv1/v2
- ▶ Disabling HTTP
- ▶ Using your own HTTPS certificate
- ▶ Using your own SSH key
- ▶ Disabling Telnet
- ▶ Disabling HiDiscovery
- ▶ Enable IP access restriction
- ▶ Adjusting the session timeouts

7.1 Changing the SNMPv1/v2 community

SNMPv1/v2 works unencrypted. Every SNMP packet contains the IP address of the sender and the plaintext community name with which the sender accesses the device. If SNMPv1/v2 is enabled, the device allows anyone who knows the community name to access the device.

The community names `public` for read accesses and `private` for write accesses are preset. If you are using SNMPv1 or SNMPv2, you change the default community name. Treat the community names with discretion.

Perform the following steps:

- Open the *Device Security > Management Access > SNMPv1/v2 Community* dialog. The dialog displays the communities that are set up.
- For the `Write` community, specify in the *Name* column the community name.
 - ▶ Up to 32 alphanumeric characters are allowed.
 - ▶ The device differentiates between upper and lower case.
 - ▶ Specify a different community name than for read access.
- To save the changes temporarily, click the button.

```
enable
configure
snmp community rw <community name>
show snmp community
save
```

Change to the Privileged EXEC mode.

Change to the Configuration mode.

Specify the community for read/write access.

Display the communities that have been configured.

Save the settings in the non-volatile memory (NVM) in the "selected" configuration profile.

7.2 Disabling SNMPv1/v2

If you need SNMPv1 or SNMPv2, use these protocols solely in environments protected from eavesdropping. SNMPv1 and SNMPv2 do not use encryption. The SNMP packets contain the community in clear text. We recommend using SNMPv3 in the device and disabling the access using SNMPv1 and SNMPv2.

Perform the following steps:

- Open the *Device Security > Management Access > Server* dialog, *SNMP* tab. The dialog displays the settings of the SNMP server.
- To deactivate the SNMPv1 protocol, you unmark the *SNMPv1* checkbox.
- To deactivate the SNMPv2 protocol, you unmark the *SNMPv2* checkbox.
- To save the changes temporarily, click the button.

```
enable
configure
no snmp access version v1
no snmp access version v2
show snmp access
save
```

Change to the Privileged EXEC mode.
Change to the Configuration mode.
Deactivate the SNMPv1 protocol.
Deactivate the SNMPv2 protocol.
Display the SNMP server settings.
Save the settings in the non-volatile memory (NVM) in the "selected" configuration profile.

7.3 Disabling HTTP

The web server provides the graphical user interface with the protocol HTTP or HTTPS. HTTPS connections are encrypted, while HTTP connections are unencrypted.

The HTTP protocol is enabled by default. If you disable HTTP, no unencrypted access to the graphical user interface is possible.

Perform the following steps:

- Open the *Device Security > Management Access > Server* dialog, *HTTP* tab.
- To disable the HTTP protocol, select the *Off* radio button in the *Operation* frame.
- To save the changes temporarily, click the button.

```
enable
configure
no http server
```

Change to the Privileged EXEC mode.
Change to the Configuration mode.
Disable the HTTP protocol.

If the HTTP protocol is disabled, then you can reach the graphical user interface of the device only by HTTPS. In the address bar of the web browser, enter the string `https://` before the IP address of the device.

When the HTTPS protocol is disabled and you also disable HTTP, then the graphical user interface is inaccessible. To work with the graphical user interface, enable the HTTPS server using the command line interface.

Perform the following steps:

```
enable
configure
https server
```

Change to the Privileged EXEC mode.
Change to the Configuration mode.
Enable the HTTPS protocol.

7.4 Disabling Telnet

The device allows you to remotely access the management functions of the device using Telnet or SSH. Telnet connections are unencrypted, while SSH connections are encrypted.

The Telnet server is enabled on the device by default. If you disable Telnet, unencrypted remote access to the command line interface is no longer possible.

Perform the following steps:

- Open the *Device Security > Management Access > Server* dialog, *Telnet* tab.
- To disable the Telnet server, select the *Off* radio button in the *Operation* frame.
- To save the changes temporarily, click the button.

enable
configure
no telnet server

Change to the Privileged EXEC mode.
Change to the Configuration mode.
Disable the Telnet server.

If the SSH server is disabled and you also disable Telnet, the access to the Command Line Interface is only possible through the V.24 interface of the device. To work remotely with the command line interface, enable SSH.

Perform the following steps:

- Open the *Device Security > Management Access > Server* dialog, *SSH* tab.
- To enable the *SSH* server, select the *On* radio button in the *Operation* frame.
- To save the changes temporarily, click the button.

enable
configure
ssh server

Change to the Privileged EXEC mode.
Change to the Configuration mode.
Enable the SSH server.

7.5 Disabling the HiDiscovery access

HiDiscovery allows you to assign IP parameters to the device over the network during commissioning. HiDiscovery communicates in the management VLAN without encryption and authentication.

After the device is commissioned, we recommend to setHiDiscoveryto read-only or to disable HiDiscovery access completely.

Perform the following steps:

- Open the *Basic Settings > Network* dialog.
- To take away write permission from the HiDiscovery software, in the *HiDiscovery protocol v1/v2* frame, specify the value `readOnly` in the *Access* field.
- To disable HiDiscovery access completely, select the `Off` radio button in the *HiDiscovery protocol v1/v2* frame.
- To save the changes temporarily, click the button.

enable
network hidiscovery mode read-only
no network hidiscovery operation

Change to the Privileged EXEC mode.
Disable write permission of the HiDiscovery software.
Disable HiDiscovery access.

7.6 Activating the IP access restriction

In the default setting, you access the management functions of the device from any IP address and with the supported protocols.

The IP access restriction allows you to restrict access to the management functions to selected IP address ranges and selected IP-based protocols.

Example:

The device is to be accessible only from the company network using the graphical user interface. The administrator has additional remote access using SSH. The company network has the address range 192.168.1.0/24 and remote access from a mobile network with the IP address range 109.237.176.0/24. The SSH application program knows the fingerprint of the RSA/DSA key.

| Parameter | Company network | Mobile phone network |
|-------------------|-----------------|----------------------|
| Network address | 192.168.1.0 | 109.237.176.0 |
| Netmask | 24 | 24 |
| Desired protocols | https, snmp | ssh |

Table 6: Parameters for the IP access restriction

Perform the following steps:

- Open the *Device Security > Management Access > IP Access Restriction* dialog.
- Unmark the checkbox in the *Active* column for the entry.

This entry allows access to the device from any IP address and the supported protocols.
Address range of the company network:

- To add a table entry, click the  button.
- Specify the address range of the company network in the *IP address range* column:
192.168.1.0/24
- For the address range of the corporate network, deactivate the undesired protocols. The *HTTPS*, *SNMP*, and *Active* checkboxes remain marked.

Address range of the mobile phone network:

- To add a table entry, click the  button.
- Specify the address range of the mobile network in the *IP address range* column:
109.237.176.0/24
- For the address range of the mobile network, deactivate the undesired protocols. The *SSH* and *Active* checkboxes remain marked.

Before you enable the function, verify that at least one active entry in the table allows you access. Otherwise, the connection to the device terminates when you change the settings. To access the management functions is possible solely using the CLI through the V.24 interface of the device.

- To enable IP access restriction, select the *On* radio button in the *Operation* frame.
- To save the changes temporarily, click the  button.

enable

```
show network management access global
show network management access rules
```

Change to the Privileged EXEC mode.

Displays whether IP access restriction is enabled or disabled.
Display the entries that have been configured.

```
no network management access operation
```

Disable the IP access restriction.

Assistance in the protection from unauthorized access

7.6 Activating the IP access restriction

| | |
|--|---|
| <pre>network management access add 2</pre> | Create the entry for the address range of the company network. Number of the next available index in this example: 2. |
| <pre>network management access modify 2 ip 192.168.1.0</pre> | Specify the IP address of the company network. |
| <pre>network management access modify 2 mask 24</pre> | Specify the netmask of the company network. |
| <pre>network management access modify 2 ssh disable</pre> | Deactivate SSH for the address range of the company network. Repeat the operation for all unwanted protocols. |
| <pre>network management access add 3</pre> | Create an entry for the address range of the mobile phone network. Number of the next available index in this example: 3. |
| <pre>network management access modify 3 ip 109.237.176.0</pre> | Specify the IP address of the mobile phone network. |
| <pre>network management access modify 3 mask 24</pre> | Specify the netmask of the mobile phone network. |
| <pre>network management access modify 3 snmp disable</pre> | Deactivate SNMP for the address range of the mobile phone network. Repeat the operation for all unwanted protocols. |
| <pre>no network management access status 1</pre> | Deactivate the default entry. This entry allows access to the device from any IP address and the supported protocols. |
| <pre>network management access status 2</pre> | Activate an entry for the address range of the company network. |
| <pre>network management access status 3</pre> | Activate an entry for the address range of the mobile phone network. |
| <pre>show network management access rules</pre> | Display the entries that have been configured. |
| <pre>network management access operation</pre> | Enable the IP access restriction. |

7.7 Adjusting the session timeouts

The device allows you to automatically terminate the session upon inactivity of the logged-on user. The session timeout is the period of inactivity after the last user action.

You can specify a session timeout for the following applications:

- ▶ CLI sessions using an SSH connection
- ▶ CLI sessions using a Telnet connection
- ▶ CLI sessions using a V.24 connection
- ▶ Graphical user interface

■ Session timeout for CLI sessions using a SSH connection

Perform the following steps:

- Open the *Device Security > Management Access > Server* dialog, *SSH* tab.
- Specify the timeout period in minutes in the *Configuration* frame, *Session timeout [min]* field.
- To save the changes temporarily, click the button.

```
enable
configure
ssh timeout <0..160>
```

Change to the Privileged EXEC mode.
Change to the Configuration mode.
Specify the timeout period in minutes for CLI sessions using an SSH connection.

■ Timeout for CLI sessions using a Telnet connection

Perform the following steps:

- Open the *Device Security > Management Access > Server* dialog, *Telnet* tab.
- Specify the timeout period in minutes in the *Configuration* frame, *Session timeout [min]* field.
- To save the changes temporarily, click the button.

```
enable
configure
telnet timeout <0..160>
```

Change to the Privileged EXEC mode.
Change to the Configuration mode.
Specify the timeout period in minutes for CLI sessions using a Telnet connection.

■ Session timeout for CLI sessions using a V.24 connection

Perform the following steps:

- Open the *Device Security > Management Access > CLI* dialog, *Global* tab.
- Specify the timeout period in minutes in the *Configuration* frame, *V.24 timeout [min]* field.
- To save the changes temporarily, click the button.

```
enable  
cli serial-timeout <0..160>
```

Change to the Privileged EXEC mode.
Specify the timeout period in minutes for CLI sessions using a V.24 connection.

■ Session timeout for the graphical user interface

Perform the following steps:

- Open the *Device Security > Management Access > Web* dialog.
- Specify the timeout period in minutes in the *Configuration* frame, *Web interface session timeout [min]* field.
- To save the changes temporarily, click the button.

```
enable  
network management access web timeout  
<0..160>
```

Change to the Privileged EXEC mode.
Specify the timeout period in minutes for graphical user interface sessions

8 Controlling the data traffic

The device checks the data packets to be forwarded in accordance with defined rules. Data packets to which the rules apply are either forwarded by the device or blocked. When data packets do not correspond to any of the rules, the device blocks the packets.

Routing ports to which no rules are assigned allow packets to pass. As soon as a rule is assigned, the assigned rules are processed first. After that, the specified standard action of the device takes effect.

The device provides the following functions for controlling the data stream:

- ▶ Service request control (Denial of Service, DoS)

The device observes and monitors the data stream. The device takes the results of the observation and the monitoring and combines them with the rules for the network security to create what is known as a status table. Based on this status table, the device decides whether to accept, drop or reject data.

8.1 Helping protect against unauthorized access

With this function, the device supports you in protecting against invalid or falsified data packets targeted at causing the failure of certain services or devices. You have the option of specifying filters in order to restrict data stream for protection against denial-of-service attacks. The activated filters check incoming data packets and discard them as soon as a match with the filter criteria is found.

The *Network Security > DoS > Global* dialog contains 2 frames in which you activate different filters. To activate them, mark the corresponding checkboxes.

In the *TCP/UDP* frame, you activate up to 4 filters that influence TCP and UDP packets exclusively. Using this filter, you deactivate port scans, which attackers use to try to recognize devices and services offered. The filters operate as follows:

| Filter | Action |
|--------------------------------|---|
| Activate Null Scan Filter | The device detects and discards TCP packets for which no TCP flags are set. |
| Activate Xmas Filter | The device detects and discards TCP packets for which the TCP flags FIN, URG and PUSH are simultaneously set. |
| Activate SYN/FIN Filter | The device detects and discards TCP packets for which the TCP flags SYN and FIN are simultaneously set. |
| Activate Minimal Header Filter | The device detects and discards TCP packets for which the TCP header is too short. |

Table 7: DoS filters for TCP packets

The *ICMP* frame offers you 2 filter options for ICMP packets. Fragmentation of incoming ICMP packets is a sign of an attack. When you activate this filter, the device detects fragmented ICMP packets and discards them. Using the *Allowed packet size [byte]* parameter, you can also specify the maximum permissible size of the payload of the ICMP packets. The device discards data packets that exceed this byte specification.

Note: You can combine the filters in any way in the *Network Security > DoS > Global* dialog. When several filters are selected, a logical Or applies: The device discards a data packet if the first or second (or the third, etc.) filter applies to it.

9 Synchronizing the system time in the network

Many applications rely on a time that is as correct as possible. The necessary accuracy, and thus the allowable deviation from the actual time, depends on the application area.

Examples of application areas include:

- ▶ Log entries
- ▶ Time stamping of production data
- ▶ Process control

The device offers the following options for synchronizing the time on the network:

- ▶ The Simple Network Time Protocol (SNTP) is a simple solution for low accuracy requirements. Under ideal conditions, SNTP achieves an accuracy in the millisecond range. The accuracy depends on the signal delay.
- ▶ IEEE 1588 with the Precision Time Protocol (PTP) achieves accuracies on the order of fractions of microseconds. This method is suitable even for demanding applications up to and including process control.

PTP is always the better choice if the involved devices support this protocol. PTP is more accurate, has advanced methods of error correction, and causes a low network load. The implementation of PTP is comparatively easy.

Note: According to the PTP and SNTP standards, both protocols function in parallel in the same network. However, since both protocols influence the system time of the device, situations may occur in which the two protocols conflict with each other.

9.1 Basic settings

In the *Time > Basic Settings* dialog, you specify general settings for the time.

9.1.1 Setting the time

If no reference time source is available to you, you have the option to set the time in the device.

After a cold start or reboot, if no real-time clock is available or if the real-time clock contains an invalid time, the device initializes its clock with January 1, 00:00h. After the power supply is switched off, the device buffers the settings of the real-time clock up to 24 hours.

Alternatively, you configure the settings in the device so that it automatically obtains the current time from a PTP clock or from an SNTP server.

Alternatively, you configure the settings in the device so that it automatically obtains the current time from an SNTP server.

Perform the following steps:

- Open the *Time > Basic Settings* dialog.
 - ▶ The *System time (UTC)* field displays the current UTC (Universal Time Coordinated) of the device. UTC is the time relating to the coordinated world time measurement. UTC is the same worldwide and does not take local time shifts into account.
 - ▶ The time in the *System time* field comes from the *System time (UTC)* plus the *Local offset [min]* value and a possible shift due to daylight saving time.
- In order to cause the device to apply the time of your PC to the *System time* field, click the *Set time from PC* button.

Based on the value in the *Local offset [min]* field, the device calculates the time in the *System time (UTC)* field: The *System time (UTC)* comes from the *System time* minus the *Local offset [min]* value and a possible shift due to daylight saving time.
- ▶ The *Time source* field displays the origin of the time data. The device automatically selects the source with the greatest accuracy.

The source is initially *local*.
If SNTP is active and if the device receives a valid SNTP packet, the device sets its time source to *sntp*.
If PTP is active and if the device receives a valid PTP message, the device sets its time source to *ptp*. The device prioritizes PTP ahead of SNTP.
- ▶ The *Local offset [min]* value specifies the time difference between the local time and the *System time (UTC)*.
- In order to cause the device to determine the time zone on your PC, click the *Set time from PC* button. The device calculates the local time difference from UTC and enters the difference into the *Local offset [min]* field.

Note: The device provides the option to obtain the local offset from a DHCP server.

- To save the changes temporarily, click the button.

```
enable
configure
clock set <YYYY-MM-DD> <HH:MM:SS>
clock timezone offset <-780..840>
save
```

Change to the Privileged EXEC mode.
Change to the Configuration mode.
Set the system time of the device.
Enter the time difference between the local time and the received UTC time in minutes.
Save the settings in the non-volatile memory (NVM) in the “selected” configuration profile.

9.1.2 Automatic daylight saving time changeover

If you operate the device in a time zone in which there is a summer time change, you set up the automatic daylight saving time changeover on the *Daylight saving time* tab.

When daylight saving time is enabled, the device sets the local system time forward by 1 hour at the beginning of daylight saving time. At the end of daylight saving time, the device sets the local system time back again by 1 hour.

Perform the following steps:

- Open the *Time > Basic Settings* dialog, *Daylight saving time* tab.
- To select a preset profile for the start and end of daylight saving time, click the *Profile...* button in the *Operation* frame.
- If no matching daylight saving time profile is available, you specify the changeover times in the *Summertime begin* and *Summertime end* fields.
For both time points, you specify the month, the week within this month, the weekday, and the time of day.
- To enable the function, select the *On* radio button in the *Operation* frame.
- To save the changes temporarily, click the button.

```
enable
configure
clock summer-time mode
<disable|recurring|eu|usa>
clock summer-time recurring start
clock summer-time recurring end
save
```

Change to the Privileged EXEC mode.
Change to the Configuration mode.
Configure the automatic daylight saving time changeover: enable/disable or activate with a profile.
Enter the start time for the changeover.
Enter the end time for the changeover.
Save the settings in the non-volatile memory (NVM) in the “selected” configuration profile.

9.2 SNTP

The Simple Network Time Protocol (SNTP) allows you to synchronize the system time in your network. The device supports the SNTP client and the SNTP server function.

The SNTP server makes the UTC (Universal Time Coordinated) available. UTC is the time relating to the coordinated world time measurement. The UTC is the same worldwide and ignores local time shifts.

SNTP is a simplified version of NTP (Network Time Protocol). The data packets are identical with SNTP and NTP. Accordingly, both NTP and SNTP servers serve as a time source for SNTP clients.

Note: Statements in this chapter relating to external SNTP servers also apply to NTP servers.

SNTP knows the following operation modes for the transmission of time:

► Unicast

In Unicast operation mode, an SNTP client sends requests to an SNTP server and expects a response from this server.

► Broadcast

In Broadcast operation mode, an SNTP server sends SNTP messages to the network in specified intervals. SNTP clients receive these SNTP messages and evaluate them.

| IP destination address | Send SNTP packets to |
|------------------------|-------------------------------------|
| 0.0.0.0 | Nobody |
| 224.0.1.1 | Multicast address for SNTP messages |
| 255.255.255.255 | Broadcast address |

Table 8: Target address classes for Broadcast operation mode

Note: An SNTP server in Broadcast operation mode also responds to direct requests using Unicast from SNTP clients. In contrast, SNTP clients work in either Unicast or Broadcast operation mode.

9.2.1 Preparation

Perform the following steps:

- To get an overview of how the time is passed on, draw a network plan with the devices participating in SNTP.

When planning, bear in mind that the accuracy of the time depends on the delays of the SNTP messages. To minimize delays and their variance, place an SNTP server in each network segment. Each of these SNTP servers synchronizes its own system time as an SNTP client with its parent SNTP server (SNTP cascade). The highest SNTP server in the SNTP cascade has the most direct access to a reference time source.

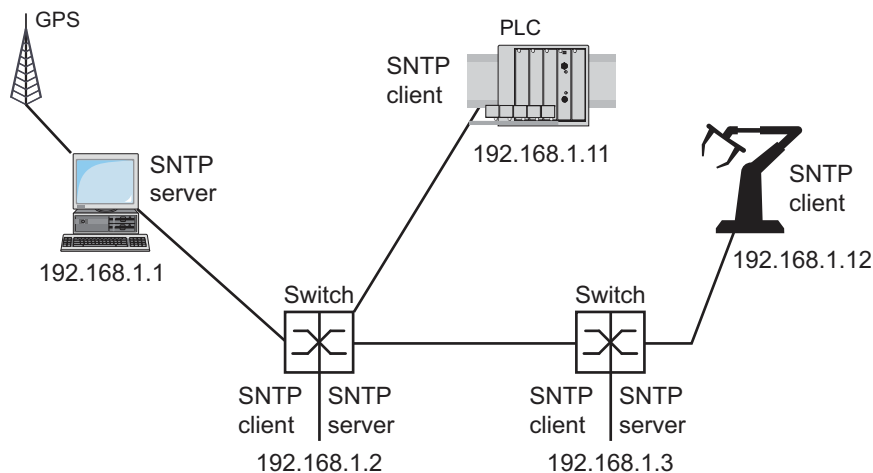

Figure 17: Example of SNTP cascade

Note: For precise time distribution, between SNTP servers and SNTP clients you preferably use network components (routers and switches) that forward the SNTP packets with a low and uniform transmission time (latency).

- ▶ An SNTP client sends its requests to up to 4 configured SNTP servers. If there is no response from the 1st SNTP server, the SNTP client sends its requests to the 2nd SNTP server. If this request is also unsuccessful, it sends the request to the 3rd and finally the 4th SNTP server. If none of these SNTP servers responds, the SNTP client loses its synchronization. The SNTP client periodically sends requests to each SNTP server until a server delivers a valid time.

Note: The device provides the option of obtaining a list of SNTP server IP addresses from a DHCP server.

- If no reference time source is available to you, determine a device with an SNTP server as a reference time source. Adjust its system time at regular intervals.

9.2.2 Defining settings of the SNTP client

As an SNTP client, the device obtains the time information from SNTP or NTP servers and synchronizes its system clock accordingly.

Perform the following steps:

- Open the *Time > SNTP > Client* dialog.
- Set the SNTP operation mode.
In the *Configuration* frame, select one of the following values in the *Mode* field:
 - ▶ *unicast*
The device sends requests to an SNTP server and expects a response from this server.
 - ▶ *broadcast*
The device waits for Broadcast messages from SNTP servers on the network.
- To synchronize the time only once, mark the *Disable client after successful sync* checkbox.
After synchronization, the device disables the *SNTP Client* function.
- ▶ The table displays the SNTP server to which the SNTP client sends a request in Unicast operation mode. The table contains up to four SNTP server definitions.
- To add a table entry, click the  button.
- Specify the connection data of the SNTP server.
- To enable the function, select the *On* radio button in the *Operation* frame.
- To save the changes temporarily, click the button.
- ▶ The *State* field displays the current status of the *SNTP Client* function.

| Device | 192.168.1.1 | 192.168.1.2 | 192.168.1.3 | 192.168.1.11 | 192.168.1.12 |
|----------------------------|-------------|-------------|----------------------------|----------------------------|---|
| SNTP Client function | Off | On | On | On | On |
| Configuration: <i>Mode</i> | unicast | unicast | unicast | unicast | unicast |
| Request interval [s] | 30 | 30 | 30 | 30 | 30 |
| SNTP Server address(es) | – | 192.168.1.1 | 192.168.1.2 192.168.1.1 | 192.168.1.2 192.168.1.1 | 192.168.1.3 192.168.1.2 192.168.1.1 |

Table 9: SNTP client settings for the example

9.2.3 Specifying SNTP server settings

When the device operates as an SNTP server, it provides its system time in coordinated world time (UTC) in the network.

Perform the following steps:

- Open the *Time > SNTP > Server* dialog.
- To enable the function, select the *On* radio button in the *Operation* frame.

- To enable the Broadcast operation mode, select the *Broadcast admin mode* radio button in the *Configuration* frame.
In Broadcast operation mode, the SNTP server sends SNTP messages to the network in specified intervals. The SNTP server also responds to the requests from SNTP clients in Unicast operation mode.
 - In the *Broadcast destination address* field, you set the IP address to which the SNTP server sends the SNTP packets. Set a Broadcast address or a Multicast address.
 - In the *Broadcast UDP port* field, you specify the number of the UDP port to which the SNTP server sends the SNTP packets in Broadcast operation mode.
 - In the *Broadcast VLAN ID* field, you specify the ID of the VLAN to which the SNTP server sends the SNTP packets in Broadcast operation mode.
 - In the *Broadcast send interval [s]* field, you enter the time interval at which the SNTP server of the device sends SNTP Broadcast packets.
- To save the changes temporarily, click the button.
- ▶ The *State* field displays the current status of the *SNTP Server* function.

| Device | 192.168.1.1 | 192.168.1.2 | 192.168.1.3 | 192.168.1.11 | 192.168.1.12 |
|-------------------------------------|-------------|-------------|-------------|--------------|--------------|
| SNTP Server function | On | On | On | Off | Off |
| UDP port | 123 | 123 | 123 | 123 | 123 |
| Broadcast admin mode | unmarked | unmarked | unmarked | unmarked | unmarked |
| Broadcast destination address | 0.0.0.0 | 0.0.0.0 | 0.0.0.0 | 0.0.0.0 | 0.0.0.0 |
| Broadcast UDP port | 123 | 123 | 123 | 123 | 123 |
| Broadcast VLAN ID | 1 | 1 | 1 | 1 | 1 |
| Broadcast send interval [s] | 128 | 128 | 128 | 128 | 128 |
| Disable server at local time source | unmarked | unmarked | unmarked | unmarked | unmarked |

Table 10: Settings for the example

9.3 PTP

In order for LAN-controlled applications to work without latency, precise time management is required. With PTP (Precision Time Protocol), IEEE 1588 describes a method that enables precise synchronization of clocks in the network.

PTP enables synchronization with an accuracy of a few 100 ns. PTP uses Multicasts for the synchronization messages, which keeps the network load low.

9.3.1 Types of clocks

PTP defines the roles of “master” and “slave” for the clocks in the network:

- ▶ A master clock (reference time source) distributes its time.
- ▶ A slave clock synchronizes itself with the timing signal received from the master clock.

■ Boundary clock

The transmission time (latency) in routers and switches has a measurable effect on the precision of the time transmission. To correct such inaccuracies, PTP defines what are known as boundary clocks.

In a network segment, a boundary clock is the reference time source (master clock) to which the subordinate slave clocks synchronize. Typically routers and switches take on the role of boundary clock.

The boundary clock in turn obtains the time from a higher-level reference time source (Grandmaster).

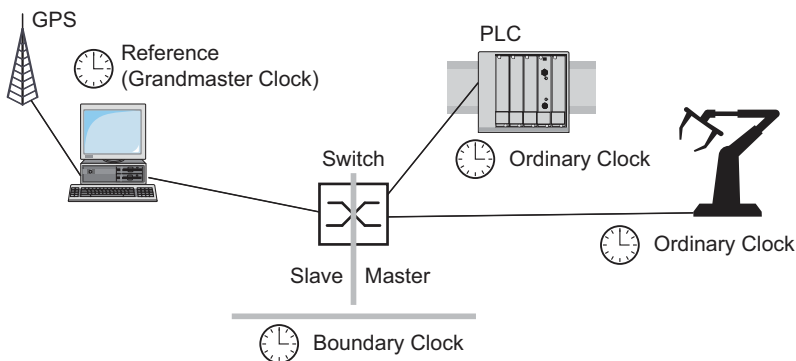

Figure 18: Position of the boundary clock in a network

■ **Transparent Clock**

Switches typically take on the Transparent Clock role to enable high accuracy across the cascades. The Transparent Clock is a Slave clock that corrects its own transmission time when it forwards received synchronization messages.

■ **Ordinary Clock**

PTP designates the clock in a end device as an “Ordinary Clock”. An Ordinary Clock functions either as a master clock or slave clock.

9.3.2 **Best Master Clock algorithm**

The devices participating in PTP designate a device in the network as a reference time source (Grandmaster). Here the “Best Master Clock” algorithm is used, which determines the accuracy of the clocks available in the network.

The “Best Master Clock” algorithm evaluates the following criteria:

- ▶ *Priority 1*
- ▶ *Clock class*
- ▶ *Clock accuracy*
- ▶ *Clock variance*
- ▶ *Priority 2*

The algorithm first evaluates the value in the *Priority 1* field of the participating devices. The device with the smallest value in the *Priority 1* field becomes the reference time source (Grandmaster). If the value is the same for multiple devices, the algorithm takes the next criterion, and if this is also the same, it takes the next criterion after this one. If all the values are the same for multiple devices, the smallest value in the *Clock identity* field decides which device becomes the reference time source (Grandmaster).

The device offers you the option in the settings of the boundary clock to individually specify the values for *Priority 1* and *Priority 2*. This allows you to influence which device will be the reference time source (Grandmaster) in the network.

9.3.3 Delay measurement

The delay of the synchronization messages between the devices affects the accuracy. The delay measurement allows the devices to take into account the average delay.

PTP version 2 offers the following methods for delay measurement:

- ▶ e2e (End to End)
The slave clock measures the delay of synchronization messages to the master clock.
- ▶ e2e-optimized
The slave clock measures the delay of synchronization messages to the master clock. This method is available only for transparent clocks. The device sends the synchronization messages sent using Multicast only to the master clock, keeping the network load low. If the device receives a synchronization message from another master clock, it sends the synchronization messages only to this new port. If the device knows no master clock, it sends synchronization messages to every port.
- ▶ p2p (Peer to Peer)
The slave clock measures the delay of synchronization messages to the master clock. In addition, the master clock measures the delay to each slave clock, even across blocked ports. This requires that the master and slave clock support Peer-to-Peer (p2p). In case of interruption of a redundant ring, for example, the slave clock becomes the master clock and the master clock becomes the slave clock. This switch occurs without loss of precision, because the clocks already know the delay in the other direction.

Note: If you specify the value `p2p`, in column *Network protocol*, you can specify the value `IEEE 802.3` only.

9.3.4 PTP domains

The device transmits synchronization messages only from and to devices in the same PTP domain. The device allows you to set the domain for the boundary clock and for the transparent clock individually.

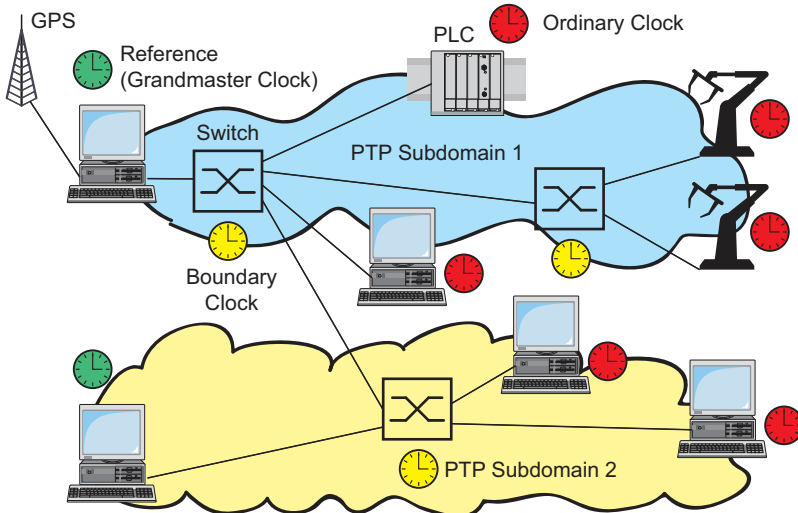

Figure 19: Example of PTP domains

9.3.5 Using PTP

In order to synchronize the clocks precisely with PTP, only use switches with a boundary clock or transparent clock as nodes.

Perform the following steps:

- To gain an overview of the distribution of clocks, draw a network plan with the devices involved in PTP.
- Specify the role for each participating switch (boundary clock or transparent clock). In the device, this setting is called *PTP mode*.

| PTP mode | Application |
|----------------------|---|
| v2-boundary-clock | As a boundary clock, the device distributes synchronization messages to the slave clocks in the subordinate network segment. The boundary clock in turn obtains the time from a higher-level reference time source (Grandmaster). |
| v2-transparent-clock | As a transparent clock, the device forwards received synchronization messages after they have been corrected by the delay of the transparent clock. |

Table 11: Possible settings for PTP mode

- Enable PTP on each participating switch. PTP is then configured on a largely automatic basis.
- Enable PTP on the end devices.
- The device allows you to influence which device in the network becomes the reference clock (Grandmaster). Therefore, change the default value in the *Priority 1* and *Priority 2* fields for the Boundary Clock.

10 Network load control

The device features a number of functions that reduce the network load:

- ▶ Direct packet distribution
- ▶ Multicasts
- ▶ Rate limiter
- ▶ Prioritization - QoS
- ▶ Flow control

10.1 Direct packet distribution

The device reduces the network load with direct packet distribution.

On each of its ports, the device learns the sender MAC address of received data packets. The device stores the combination “port and MAC address” in its MAC address table (FDB).

By applying the “Store and Forward” method, the device buffers data received and checks it for validity before forwarding it. The device rejects invalid and defective data packets.

10.1.1 Learning MAC addresses

If the device receives a data packet, it checks whether the MAC address of the sender is already stored in the MAC address table (FDB). If the MAC address of the sender is unknown, the device generates a new entry. The device then compares the destination MAC address of the data packet with the entries stored in the MAC address table (FDB):

- ▶ The device sends packets with a known destination MAC address directly to ports that have already received data packets from this MAC address.
- ▶ The device floods data packets with unknown destination addresses, that is, the device forwards these data packets to all ports.

10.1.2 Aging of learned MAC addresses

Addresses that have not been detected by the device for an adjustable period of time (aging time) are deleted from the MAC address table (FDB) by the device. A reboot or resetting of the MAC address table deletes the entries in the MAC address table (FDB).

10.1.3 Static address entries

In addition to learning the sender MAC address, the device also provides the option to set MAC addresses manually. These MAC addresses remain configured and survive resetting of the MAC address table (FDB) as well as rebooting of the device.

Static address entries allow the device to forward data packets directly to selected ports. If you do not specify a destination port, the device discards the corresponding data packets.

You manage the static address entries in the graphical user interface (GUI) or in the CLI.

Perform the following steps:

- Create a static address entry.

- Open the *Switching > Filter for MAC Addresses* dialog.

- Add a user-configurable MAC address:

- ▶ Click the  button.

The dialog displays the *Create* window.

- ▶ In the *Address* field, specify the destination MAC address.
- ▶ In the *VLAN ID* field, specify the ID of the VLAN.

- ▶ In the *Port* list, select the ports to which the device sends data packets with the specified destination MAC address in the specified VLAN.

Select exactly one port if you have defined a Unicast MAC address in the *Address* field.

Select one or more ports if you have defined a Multicast MAC address in the *Address* field.

Do not select any port if you want the device to discard data packets with the destination MAC address.

- ▶ Click the *Ok* button.

- To save the changes temporarily, click the button.

```
enable
configure
mac-filter <MAC address> <VLAN ID>

interface 1/1
mac-filter <MAC address> <VLAN ID>
save
```

Change to the Privileged EXEC mode.
Change to the Configuration mode.
Create the MAC address filter, consisting of a MAC address and VLAN ID.
Change to the interface configuration mode of interface 1/1.
Assign the port to a previously created MAC address filter.
Save the settings in the non-volatile memory (nvm) in the "selected" configuration profile.

- Convert a learned MAC address into a static address entry.

- Open the *Switching > Filter for MAC Addresses* dialog.
- To convert a learned MAC address into a static address entry, select the value `permanent` in the *Status* column.
- To save the changes temporarily, click the button.

- Disable a static address entry.

- Open the *Switching > Filter for MAC Addresses* dialog.
- To disable a static address entry, select the value `invalid` in the *Status* column.
- To save the changes temporarily, click the button.

```
enable
configure
interface 1/1
no mac-filter <MAC address> <VLAN ID>
exit
no mac-filter <MAC address> <VLAN ID>

exit
save
```

Change to the Privileged EXEC mode.
Change to the Configuration mode.
Change to the interface configuration mode of interface 1/1.
Cancel the assignment of the MAC address filter on the port.
Change to the Configuration mode.
Deleting the MAC address filter, consisting of a MAC address and VLAN ID.
Change to the Privileged EXEC mode.
Save the settings in the non-volatile memory (nvm) in the "selected" configuration profile.

- Delete learned MAC addresses.

- To delete the learned addresses from the MAC address table (FDB), open the *Basic Settings > Restart* dialog and click the *Reset MAC address table* button.

```
clear mac-addr-table
```

Delete the learned MAC addresses from the MAC address table (FDB).

10.2 Multicasts

By default, the device floods data packets with a Multicast address, that is, the device forwards the data packets to all ports. This leads to an increased network load.

The use of IGMP snooping can reduce the network load caused by Multicast data traffic. IGMP snooping allows the device to send Multicast data packets only on those ports to which devices “interested” in multicast are connected.

10.2.1 Example of a Multicast application

Surveillance cameras transmit images to monitors in the machine room and in the monitoring room. With an IP Multicast transmission, the cameras transmit their graphic data over the network in Multicast packets.

The Internet Group Management Protocol (IGMP) organizes the Multicast data traffic between the Multicast routers and the monitors. The switches in the network between the Multicast routers and the monitors monitor the IGMP data traffic continuously (“IGMP Snooping”).

Switches register logins for receiving a Multicast stream (IGMP report). The device then creates an entry in the MAC address table (FDB) and forwards Multicast packets only to the ports on which it has previously received IGMP reports.

10.2.2 IGMP snooping

The Internet Group Management Protocol (IGMP) describes the distribution of Multicast information between routers and connected receivers on Layer 3. IGMP Snooping describes the function of a switch of continuously monitoring IGMP traffic and optimizing its own transmission settings for this data traffic.

The IGMP snooping function in the device operates according to RFC 4541 (Considerations for Internet Group Management Protocol (IGMP) and Multicast Listener Discovery (MLD) Snooping Switches).

Multicast routers with an active *IGMP* function periodically request (query) registration of Multicast streams in order to determine the associated IP Multicast group members. IP Multicast group members reply with a Report message. This Report message contains the parameters required by the *IGMP* function. The Multicast router enters the IP Multicast group address from the Report message in its routing table. This causes it to forward data packets with this IP Multicast group in the destination address field according to its routing table.

Receivers log out with a “Leave” message when leaving a Multicast group (IGMP version 2 and higher) and do not send any more Report messages. The Multicast router removes the routing table entry of a receiver if it does not receive any more Report messages from this receiver within a certain time (aging time).

If several IGMP Multicast routers are in the same network, then the device with the smaller IP address takes over the query function. If there are no Multicast routers on the network, then you have the option to enable the query function in an appropriately equipped switch.

A switch that connects one Multicast receiver with a Multicast router analyzes the IGMP information with the IGMP snooping method.

The IGMP snooping method also makes it possible for switches to use the IGMP function. A switch stores the MAC addresses derived from IP addresses of the Multicast receivers as recognized Multicast addresses in its MAC address table (FDB). In addition, the switch identifies the ports on which it has received reports for a specific Multicast address. In this way the switch transmits Multicast packets exclusively on ports to which Multicast receivers are connected. The other ports do not receive these packets.

A special feature of the device is the possibility of determining the processing of data packets with unknown Multicast addresses. Depending on the setting, the device discards these data packets or forwards them to all ports. By default, the device transmits the data packets only to ports with connected devices, which in turn receive query packets. You also have the option of additionally sending known Multicast packets to query ports.

■ Setting IGMP snooping

Perform the following steps:

- Open the *Switching > IGMP Snooping > Global* dialog.
- To enable the function, select the *On* radio button in the *Operation* frame.

When the *IGMP Snooping* function is disabled, the device behaves as follows:

- ▶ The device ignores the received query and report messages.
- ▶ The device sends (floods) received data packets with a Multicast address as the destination address on every port.

- To save the changes temporarily, click the button.

Specifying the settings for a port:

- Open the *Switching > IGMP Snooping > Configuration* dialog, *Port* tab.
- To activate the *IGMP Snooping* function on a port, mark the checkbox in the *Active* column for the relevant port.

- To save the changes temporarily, click the button.

Specifying the settings for a VLAN:

- Open the *Switching > IGMP Snooping > Configuration* dialog, *VLAN ID* tab.
- To activate the *IGMP Snooping* function for a specific VLAN, mark the checkbox in the *Active* column for the relevant VLAN.

- To save the changes temporarily, click the button.

■ Setting the IGMP querier function

The device itself optionally sends active query messages; alternatively, it responds to query messages or detects other Multicast queriers in the network (*IGMP Snooping Querier* function).

Prerequisite:

The *IGMP Snooping* function is enabled globally.

Perform the following steps:

- Open the *Switching > IGMP Snooping > Querier* dialog.
- In the *Operation* frame, enable/disable the *IGMP Snooping Querier* function of the device globally.
- To activate the *IGMP Snooping Querier* function for a specific VLAN, mark the checkbox in the *Active* column for the relevant VLAN.
 - ▶ The device carries out a simple selection process: If the IP source address of the other Multicast querier is lower than its own, the device switches to the passive state, in which it does not send out any more query requests.
 - ▶ In the *Address* column, you specify the IP Multicast address that the device inserts as the sender address in generated query requests. You use the address of the Multicast router.
- To save the changes temporarily, click the button.

■ IGMP snooping enhancements (table)

The *Switching > IGMP Snooping > Snooping Enhancements* dialog provides you access to enhanced settings for the *IGMP Snooping* function. You activate or deactivate the settings on a per port basis in a VLAN.

The following settings are possible:

- ▶ **Static**
Use this setting to set the port as a static query port. The device sends every IGMP message on a static query port, even if it has previously received no IGMP query messages on this port. If the static option is disabled, the device sends IGMP messages on this port only if it has previously received IGMP query messages. If that is the case, the entry displays **L** (“learned”).
- ▶ **Learn by LLDP**
A port with this setting automatically discovers other Hirschmann devices using LLDP (Link Layer Discovery Protocol). The device then learns the IGMP query status of this port from these Hirschmann devices and configures the *IGMP Snooping Querier* function accordingly. The **ALA** entry indicates that the **Learn by LLDP** function is activated. If the device has found another Hirschmann device on this port in this VLAN, the entry also displays an **A** (“automatic”).
- ▶ **Forward All**
With this setting, the device sends the data packets addressed to a Multicast address on this port. The setting is suitable in the following situations, for example:
 - For diagnostic purposes.
 - For devices in an MRP ring: After the ring is switched, the **Forward All** function allows rapid reconfiguration of the network for data packets with registered Multicast destination addresses. Activate the **Forward All** function on all ring ports.

Prerequisite:

The *IGMP Snooping* function is enabled globally.

Perform the following steps:

- Open the *Switching > IGMP Snooping > Snooping Enhancements* dialog.
- Double-click the desired port in the desired VLAN.
- To activate one or more functions, select the corresponding options.
- Click the *Ok* button.
- To save the changes temporarily, click the button.

enable

vlan database

igmp-snooping vlan-id 1 forward-all 1/1

Change to the Privileged EXEC mode.

Change to the VLAN configuration mode.

Activate the **Forward All** function for port 1/1 in VLAN 1.

■ Configure Multicasts

The device allows you to configure the exchange of Multicast data packets. The device provides different options depending on whether the data packets are to be sent to unknown or known Multicast receivers.

The settings for unknown Multicast addresses are global for the entire device. The following options can be selected:

- ▶ The device discards unknown Multicasts.
- ▶ The device sends unknown Multicasts on every port.
- ▶ The device sends unknown Multicasts exclusively on ports that have previously received query messages (query ports).

Note: The exchange settings for unknown Multicast addresses also apply to the reserved IP addresses from the “Local Network Control Block” (224.0.0.0..224.0.0.255). This behavior may affect higher-level routing protocols.

For each VLAN, you specify the sending of Multicast packets to known Multicast addresses individually. The following options can be selected:

- ▶ The device sends known Multicasts on the ports that have previously received query messages (query ports) and to the registered ports. Registered ports are ports with Multicast receivers registered with the corresponding Multicast group. This option ensures that the transfer works with basic applications without further configuration.
- ▶ The device sends out known Multicasts only on the registered ports. The advantage of this setting is that it uses the available bandwidth optimally through direct distribution.

Prerequisite:

The *IGMP Snooping* function is enabled globally.

Perform the following steps:

- Open the *Switching > IGMP Snooping > Multicasts* dialog.
- In the *Configuration* frame, you specify how the device sends data packets to unknown Multicast addresses.
 - ▶ *send to registered ports*
The device sends packets with unknown Multicast address to every query port.
 - ▶ *send to query and registered ports*
The device sends packets with unknown Multicast address to every port.
- In the *Known multicasts* column, you specify how the device sends data packets to known Multicast addresses in the corresponding VLAN. Click the relevant field and select the desired value.
- To save the changes temporarily, click the button.

10.3 Rate limiter

The rate limiter function allows you to limit the data traffic on the ports in order to ensure stable operation even when there is a high level of traffic. The rate limitation is performed individually for each port, as well as separately for inbound and outbound traffic.

If the data rate on a port exceeds the defined limit, the device discards the overload on this port.

Rate limitation occurs entirely on Layer 2. In the process, the rate limiter function ignores protocol information on higher levels such as IP or TCP. This may affect the TCP traffic.

To minimize these effects, use the following options:

- ▶ Limit the rate limitation to certain packet types, for example, Broadcasts, Multicasts, and Unicasts with an unknown destination address.
- ▶ Limit the outbound data traffic instead of the inbound traffic. The outbound rate limitation works better with TCP flow control due to device-internal buffering of the data packets.
- ▶ Increase the aging time for learned Unicast addresses.

Perform the following steps:

- Open the *Switching > Rate Limiter* dialog.
- ▶ Activate the rate limiter and set limits for the data rate. The settings apply on a per port basis and are broken down by type of traffic:
 - ▶ Received Broadcast data packets
 - ▶ Received Multicast data packets
 - ▶ Received Unicast data packets with an unknown destination address

To activate the rate limiter on a port, mark the checkbox for at least one category. In the *Threshold unit* column, you specify whether the device interpretes the threshold values as percent of the port bandwidth or as packets per second. The threshold value 0 deactivates the rate limiter.

- To save the changes temporarily, click the button.

10.4 QoS/Priority

QoS (Quality of Service) is a procedure defined in IEEE 802.1D which is used to distribute resources in the network. QoS allows you to prioritize the data of important applications.

Prioritizing prevents data traffic with lower priority from interfering with delay-sensitive data traffic, especially when there is a heavy network load. Delay-sensitive data traffic includes, for example, voice, video, and real-time data.

10.4.1 Description of prioritization

For data traffic prioritization, traffic classes are defined in the device. The device prioritizes higher traffic classes over lower traffic classes. The number of traffic classes depends on the device type.

To provide for optimal data flow for delay-sensitive data, you assign higher traffic classes to this data. You assign lower traffic classes to data that is less sensitive to delay.

■ Assigning traffic classes to the data

The device automatically assigns traffic classes to inbound data (traffic classification). The device takes the following classification criteria into account:

- ▶ Methods according to which the device carries out assignment of received data packets to traffic classes:
 - ▶ `trustDot1p`
The device uses the priority of the data packet contained in the VLAN tag.
 - ▶ `trustIpDscp`
The device uses the QoS information contained in the IP header (ToS/DiffServ).
 - ▶ `untrusted`
The device ignores possible priority information within the data packets and uses the priority of the receiving port directly.
- ▶ The priority assigned to the receiving port.

Both classification criteria are configurable.

During traffic classification, the device uses the following rules:

- ▶ When the receiving port is set to `trustDot1p` (default setting), the device uses the data packet priority contained in the VLAN tag. When the data packets do not contain a VLAN tag, the device is guided by the priority of the receiving port.
- ▶ When the receiving port is set to `trustIpDscp`, the device uses the QoS information (ToS/DiffServ) in the IP header. When the data packets do not contain IP packets, the device is guided by the priority of the receiving port.
- ▶ When the receiving port is set to `untrusted`, the device is guided by the priority of the receiving port.

■ Prioritizing traffic classes

For prioritization of traffic classes, the device uses the following methods:

- ▶ `Strict`
When transmission of data of a higher traffic class is no longer taking place or the relevant data is still in the queue, the device sends data of the corresponding traffic class. If every traffic class is prioritized according to the `Strict` method, under high network load the device may permanently block the data of lower traffic classes.
- ▶ `Weighted Fair Queuing`
The traffic class is assigned a guaranteed bandwidth. This ensures that the device sends the data traffic of this traffic class even if there is a great deal of data traffic in higher traffic classes.

10.4.2 Handling of received priority information

Applications label data packets with the following prioritization information:

- ▶ VLAN priority based on IEEE 802.1Q/ 802.1D (Layer 2)
- ▶ Type-of-Service (ToS) or DiffServ (DSCP) for VLAN Management IP packets (Layer 3)

The device offers the following options for evaluating this priority information:

- ▶ `trustDot1p`
The device assigns VLAN-tagged data packets to the different traffic classes according to their VLAN priorities. The corresponding allocation is configurable. The device assigns the priority of the receiving port to data packets it receives without a VLAN tag.
- ▶ `trustIpDscp`
The device assigns the IP packets to the different traffic classes according to the DSCP value in the IP header, even if the packet was also VLAN-tagged. The corresponding allocation is configurable. The device prioritizes non-IP packets according to the priority of the receiving port.
- ▶ `untrusted`
The device ignores the priority information in the data packets and assigns the priority of the receiving port to them.

10.4.3 VLAN tagging

For the VLAN and prioritizing functions, the IEEE 802.1Q standard provides for integrating a MAC frame in the VLAN tag. The VLAN tag consists of 4 bytes and is between the source address field (“Source Address Field”) and type field (“Length / Type Field”).

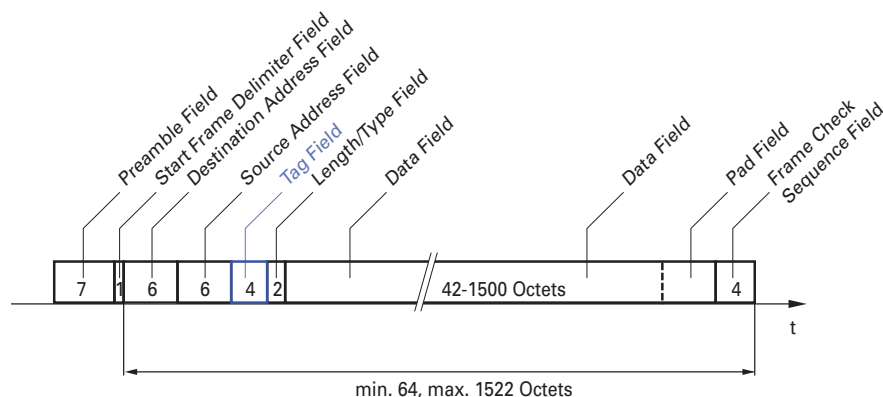

Figure 20: Ethernet data packet with tag

For data packets with VLAN tags, the device evaluates the following information:

- ▶ Priority information
- ▶ VLAN tagging, if VLANs are configured

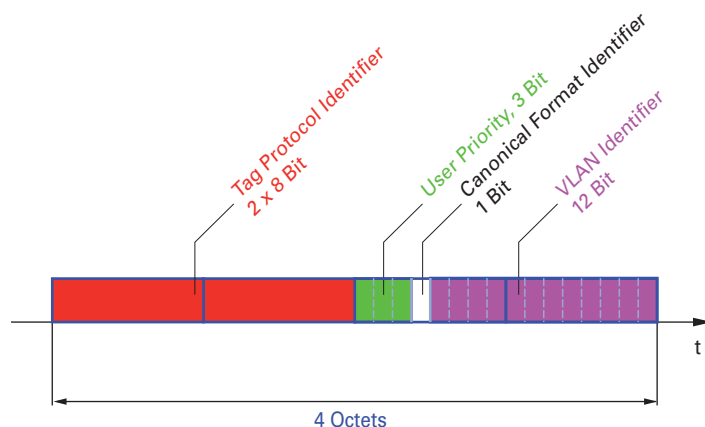

Figure 21: Structure of the VLAN tagging

Data packets with VLAN tags containing priority information but no VLAN information (VLAN ID = 0), are known as Priority Tagged Frames.

Note: Network protocols and redundancy mechanisms use the highest traffic class 7. Therefore, select other traffic classes for application data.

When using VLAN prioritizing, consider the following special features:

- ▶ End-to-end prioritizing requires the VLAN tags to be transmitted to the entire network. The prerequisite is that every network component is VLAN-capable.
- ▶ Routers are not able to send and receive packets with VLAN tags through port-based router interfaces.

10.4.4 IP ToS (Type of Service)

The Type-of-Service field (ToS) in the IP header was already part of the IP protocol from the start, and is used to differentiate different services in IP networks. Even back then, there were ideas about differentiated treatment of IP packets, due to the limited bandwidth available and the unreliable connection paths. Because of the continuous increase in the available bandwidth, there was no need to use the ToS field.

Only with the real-time requirements of today's networks has the ToS field become significant again. Selecting the ToS byte of the IP header enables you to differentiate between different services. However, this field is not widely used in practice.



| Bits (0-2): IP Precedence Defined | Bits (3-6): Type of Service Defined | Bit (7) |
|-----------------------------------|-------------------------------------|------------------|
| 111 - Network Control | 0000 - [all normal] | 0 - Must be zero |
| 110 - Internetwork Control | 1000 - [minimize delay] | |
| 101 - CRITIC / ECP | 0100 - [maximize throughput] | |
| 100 - Flash Override | 0010 - [maximize reliability] | |
| 011 - Flash | 0001 - [minimize monetary cost] | |
| 010 - Immediate | | |
| 001 - Priority | | |
| 000 - Routine | | |

Table 12: ToS field in the IP header

10.4.5 Handling of traffic classes

The device provides the following options for handling traffic classes:

- ▶ Strict Priority
- ▶ Weighted Fair Queuing
- ▶ Strict Priority combined with Weighted Fair Queuing
- ▶ Queue management

■ Strict Priority description

With the Strict Priority setting, the device first transmits data packets that have a higher traffic class (higher priority) before transmitting a data packet with the next highest traffic class. The device transmits a data packet with the lowest traffic class (lowest priority) when there are no other data packets remaining in the queue. In unfortunate cases, the device never sends packets with a low priority if there is a high volume of high-priority traffic waiting to be sent on this port. In delay-sensitive applications, such as VoIP or video, Strict Priority allows data to be sent immediately.

■ Weighted Fair Queuing description

With Weighted Fair Queuing, also called Weighted Round Robin (WRR), the user assigns a minimum or reserved bandwidth to each traffic class. This ensures that data packets with a lower priority are also sent when the network is very busy.

The reserved values range from 0% through 100% of the available bandwidth, in steps of 1%.

- ▶ A reservation of 0 is equivalent to a "no bandwidth" setting.
- ▶ The sum of the individual bandwidths may add up to 100%.

If you assign Weighted Fair Queuing to every traffic class, the entire bandwidth of the corresponding port is available to you.

■ Combining Strict Priority and Weighted Fair Queuing

When combining Weighted Fair Queuing with Strict Priority, ensure that the highest traffic class of Weighted Fair Queuing is lower than the lowest traffic class of Strict Priority.

When you combine Weighted Fair Queuing with Strict Priority, a high Strict Priority network load can significantly reduce the bandwidth available for Weighted Fair Queuing.

10.4.6 Queue management

■ Defining settings for queue management

Perform the following steps:

- Open the *Switching > QoS/Priority > Queue Management* dialog.
The total assigned bandwidth in the *Min. bandwidth [%]* column is 100%.
- To activate Weighted Fair Queuing for *Traffic class* = 0, proceed as follows:
 - ▶ Unmark the checkbox in the *Strict priority* column.
 - ▶ In the *Min. bandwidth [%]* column, specify the value 5.
- To activate Weighted Fair Queuing for *Traffic class* = 1, proceed as follows:
 - ▶ Unmark the checkbox in the *Strict priority* column.
 - ▶ In the *Min. bandwidth [%]* column, specify the value 20.
- To activate Weighted Fair Queuing for *Traffic class* = 2, proceed as follows:
 - ▶ Unmark the checkbox in the *Strict priority* column.
 - ▶ In the *Min. bandwidth [%]* column, specify the value 30.
- To activate Strict Priority for *Traffic class* = 3, proceed as follows:
 - ▶ Mark the checkbox in the *Strict priority* column.
- To activate Weighted Fair Queuing for *Traffic class* = 4, proceed as follows:
 - ▶ Unmark the checkbox in the *Strict priority* column.
 - ▶ In the *Min. bandwidth [%]* column, specify the value 10.
- To save the changes temporarily, click the button.

| | | |
|-------------------------------|---|----------------|
| enable | Change to the Privileged EXEC mode. | |
| configure | Change to the Configuration mode. | |
| cos-queue weighted 0 | Enabling Weighted Fair Queuing for traffic class 0. | |
| cos-queue min-bandwidth: 0 5 | Assigning a weight of 5 % to traffic class 0. | |
| cos-queue weighted 1 | Enabling Weighted Fair Queuing for traffic class 1. | |
| cos-queue min-bandwidth: 1 20 | Assigning a weight of 20 % to traffic class 1. | |
| cos-queue weighted 2 | Enabling Weighted Fair Queuing for traffic class 2. | |
| cos-queue min-bandwidth: 2 30 | Assigning a weight of 30 % to traffic class 2. | |
| show cos-queue | | |
| Queue Id | Min. bandwidth | Scheduler type |
| ----- | ----- | ----- |
| 0 | 5 | weighted |
| 1 | 20 | weighted |
| 2 | 30 | weighted |
| 3 | 0 | strict |
| 4 | 0 | strict |
| 5 | 0 | strict |
| 6 | 0 | strict |
| 7 | 0 | strict |

10.4.7 Management prioritization

In order for you to have full access to the management of the device, even when there is a high network load, the device allows you to prioritize management packets.

When prioritizing management packets, the device sends the management packets with priority information.

- ▶ On Layer 2, the device modifies the VLAN priority in the VLAN tag.
For this function to be useful, the configuration of the corresponding ports must permit the sending of packets with a VLAN tag.
- ▶ On Layer 3, the device modifies the IP-DSCP value.

10.4.8 Setting prioritization

■ Assigning the port priority

Perform the following steps:

- Open the *Switching > QoS/Priority > QoS/Priority Port Configuration* dialog.
- In the *Port priority* column, you specify the priority with which the device sends the data packets received on this port without a VLAN tag.
- In the *Trust mode* column, you specify the criteria the device uses to assign a traffic class to data packets received.

- To save the changes temporarily, click the button.

```
enable
configure
interface 1/1
vlan priority 3
exit
```

Change to the Privileged EXEC mode.
Change to the Configuration mode.
Change to the interface configuration mode of interface 1/1.
Assign interface 1/1 the port priority 3.
Change to the Configuration mode.

■ Assigning VLAN priority to a traffic class

Perform the following steps:

- Open the *Switching > QoS/Priority > 802.1D/p Mapping* dialog.
- To assign a traffic class to a VLAN priority, insert the associated value in the *Traffic class* column.
- To save the changes temporarily, click the button.

```
enable
configure
classofservice dot1p-mapping 0 2
classofservice dot1p-mapping 1 2
exit
show classofservice dot1p-mapping
```

Change to the Privileged EXEC mode.
Change to the Configuration mode.
Assigning a VLAN priority of 0 to traffic class 2.
Assigning a VLAN priority of 1 to traffic class 2.
Change to the Privileged EXEC mode.
Display the assignment.

■ Assign port priority to received data packets

Perform the following steps:

```
enable
configure
interface 1/1
classofservice trust untrusted
classofservice dot1p-mapping 0 2
classofservice dot1p-mapping 1 2
vlan priority 1
exit
exit
show classofservice trust
```

Change to the Privileged EXEC mode.
Change to the Configuration mode.
Change to the interface configuration mode of interface 1/1.
Assigning the *untrusted* mode to the interface.
Assigning a VLAN priority of 0 to traffic class 2.
Assigning a VLAN priority of 1 to traffic class 2.
Specifying the value 1 for the port priority.
Change to the Configuration mode.
Change to the Privileged EXEC mode.
Displaying the Trust mode of the ports/interfaces.

```
Interface Trust Mode
-----
1/1      untrusted
1/2      dot1p
1/3      dot1p
1/4      dot1p
1/5      dot1p
1/6      dot1p
1/7      dot1p
```

■ Assigning DSCP to a traffic class

Perform the following steps:

- Open the *Switching > QoS/Priority > IP DSCP Mapping* dialog.
- Specify the desired value in the *Traffic class* column.

To save the changes temporarily, click the button.

```
enable
configure
classofservice ip-dscp-mapping cs1 1
show classofservice ip-dscp-mapping
```

Change to the Privileged EXEC mode.
Change to the Configuration mode.
Assigning the DSCP value CS1 to traffic class 1.
Displaying the IP DSCP assignments

| IP DSCP | Traffic Class |
|---------|---------------|
| be | 2 |
| 1 | 2 |
| . | . |
| . | . |
| (cs1) | 1 |
| . | . |

Assign the DSCP priority to received IP data packets

Perform the following steps:

```
enable
configure
interface 1/1
classofservice trust ip-dscp
exit
show classofservice trust
```

Change to the Privileged EXEC mode.
Change to the Configuration mode.
Change to the interface configuration mode of interface 1/1.
Assigning the trust ip-dscp mode globally.
Change to the Configuration mode.
Displaying the Trust mode of the ports/interfaces.

| Interface | Trust Mode |
|-----------|------------|
| 1/1 | ip-dscp |
| 1/2 | dot1p |
| 1/3 | dot1p |
| . | . |
| . | . |
| 1/5 | dot1p |
| . | . |

Configuring Layer 2 management priority

Perform the following steps:

- Open the *Switching > QoS/Priority > QoS/Priority Global* dialog.
- In the *VLAN priority for management packets* field, specify the VLAN priority with which the device sends management data packets.
- To save the changes temporarily, click the button.

```
enable
network management priority dot1p 7
show network parms
```

Change to the Privileged EXEC mode.
Assigning the VLAN priority of 7 to management packets. The device sends management packets with the highest priority.
Displaying the priority of the VLAN in which the device management is located.

```
IPv4 Network
-----
...
Management VLAN priority.....7
...
```

■ Configuring Layer 3 management priority

Perform the following steps:

- Open the *Switching > QoS/Priority > QoS/Priority Global* dialog.
- In the *IP DSCP value for management packets* field, specify the DSCP value with which the device sends management data packets.
- To save the changes temporarily, click the button.

```
enable
network management priority ip-dscp 56

show network parms
```

Change to the Privileged EXEC mode.
Assigning the DSCP value of 56 to management packets. The device sends management packets with the highest priority.
Displaying the priority of the VLAN in which the device management is located.

```
IPv4 Network
-----
...
Management IP-DSCP value.....56
```

10.5 Flow control

If a large number of data packets are received in the priority queue of a port at the same time, this can cause the port memory to overflow. This happens, for example, when the device receives data on a Gigabit port and forwards it to a port with a lower bandwidth. The device discards surplus data packets.

The flow control mechanism described in standard IEEE 802.3 ensures that no data packets are lost due to a port memory overflowing. Shortly before a port memory is completely full, the device signals to the connected devices that it is not accepting any more data packets from them.

- ▶ In full-duplex mode, the device sends a pause data packet.
- ▶ In half-duplex mode, the device simulates a collision.

The following figure displays how flow control works. Workstations 1, 2, and 3 want to simultaneously transmit a large amount of data to Workstation 4. The combined bandwidth of Workstations 1, 2, and 3 is greater than the bandwidth of Workstation 4. This causes an overflow on the receive queue of port 4. The left funnel symbolizes this status.

If the flow control function on ports 1, 2 and 3 of the device is enabled, the device reacts before the funnel overflows. The funnel on the right illustrates ports 1, 2 and 3 sending a message to the transmitting devices to control the transmission speed. This results in the receiving port no longer being overwhelmed and is able to process the incoming traffic.

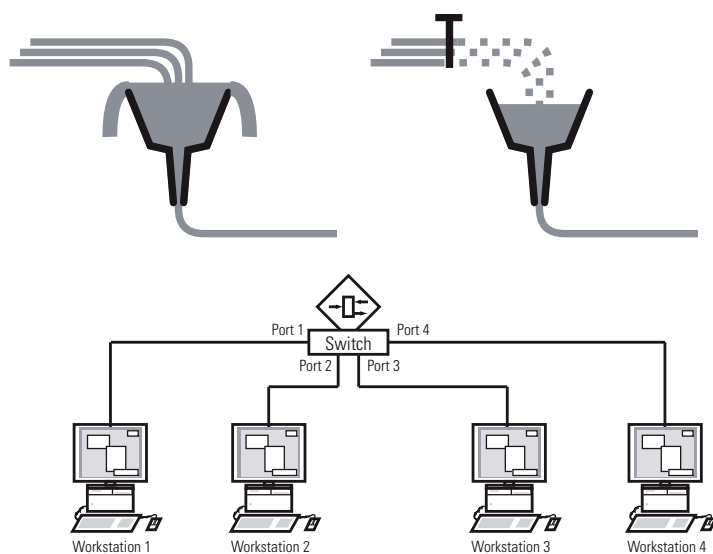

Figure 22: Example of flow control

10.5.1 Halfduplex or fullduplex link

■ Flow Control with a half duplex link

In the example, there is a halfduplex link between Workstation 2 and the device.

Before the send queue of port 2 overflows, the device sends data back to Workstation 2. Workstation 2 detects a collision and stops transmitting.

■ Flow Control with a full duplex link

In the example, there is a fullduplex link between Workstation 2 and the device.

Before the send queue of port 2 overflows, the device sends a request to Workstation 2 to include a small break in the sending transmission.

10.5.2 Setting up the Flow Control

Perform the following steps:

- Open the *Switching > Global* dialog.
- Mark the *Flow control* checkbox.
With this setting you enable flow control in the device.
- Open the *Basic Settings > Port* dialog, *Configuration* tab.
- To enable the Flow Control on a port, mark the checkbox in the *Flow control* column.
- To save the changes temporarily, click the button.

Note: When you are using a redundancy function, you deactivate the flow control on the participating ports. If the flow control and the redundancy function are active at the same time, there is a risk that the redundancy function operates differently than intended.

11 VLANs

In the simplest case, a virtual LAN (VLAN) consists of a group of network participants in one network segment who can communicate with each other as if they belonged to a separate LAN.

More complex VLANs span out over multiple network segments and are also based on logical (instead of only physical) connections between network participants. VLANs are an element of flexible network design. It is easier to reconfiguring logical connections centrally than cable connections.

The device supports independent VLAN learning in accordance with the IEEE 802.1Q standard which defines the **VLAN** function.

Using VLANs has many benefits. The following list displays the top benefits:

- ▶ Network load limiting
VLANs reduce the network load considerably as the devices transmit Broadcast, Multicast, and Unicast packets with unknown (unlearned) destination addresses exclusively inside the virtual LAN. The rest of the data network forwards traffic as normal.
- ▶ Flexibility
You have the option of forming user groups based on the function of the participants apart from their physical location or medium.
- ▶ Clarity
VLANs give networks a clear structure and make maintenance easier.

11.1 Examples of VLANs

The following practical examples provide a quick introduction to the structure of a VLAN.

Note: When configuring VLANs you use an interface for management that will remain unchanged. For this example, you use either interface 1/6 or the V.24 serial connection to configure the VLANs.

11.1.1 Example 1

The example displays a minimal VLAN configuration (port-based VLAN). An administrator has connected multiple end devices to a transmission device and assigned them to 2 VLANs. This effectively prohibits any data transmission between the VLANs, whose members communicate only within their own VLANs.

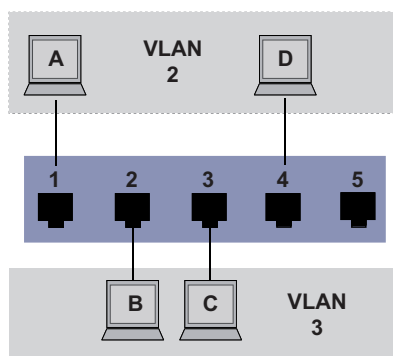

Figure 23: Example of a simple port-based VLAN

When setting up the VLANs, you create communication rules for every port, which you enter in ingress (incoming) and egress (outgoing) tables.

The ingress table specifies which VLAN ID a port assigns to the incoming data packets. Hereby, you use the port address of the end device to assign it to a VLAN.

The egress table specifies on which ports the device sends the packets from this VLAN.

- ▶ T = Tagged (with a tag field, marked)
- ▶ U = Untagged (without a tag field, unmarked)

For this example, the status of the TAG field of the data packets has no relevance, so you use the setting U.

| Terminal | Port | Port VLAN identifier (PVID) |
|----------|------|-----------------------------|
| A | 1 | 2 |
| B | 2 | 3 |
| C | 3 | 3 |
| D | 4 | 2 |
| | 5 | 1 |

Table 13: Ingress table

| VLAN ID | Port | | | | |
|---------|------|---|---|---|---|
| | 1 | 2 | 3 | 4 | 5 |
| 1 | | | | | U |
| 2 | U | | | U | |
| 3 | | U | U | | |

Table 14: Egress table

Perform the following steps:

Setting up the VLAN

- Open the *Switching > VLAN > VLAN Configuration* dialog.
- Click the  button.
The dialog displays the *Create* window.
- In the *VLAN ID* field, specify the value 2.
- Click the *Ok* button.
- For the VLAN, specify the name VLAN2:
Double-click in the *Name* column and specify the name.
For VLAN 1, in the *Name* column, change the value *Default* to VLAN1.
- Repeat the previous steps to create a VLAN 3 with the name VLAN3.

```
enable
vlan database
vlan add 2
name 2 VLAN2
vlan add 3
name 3 VLAN3
name 1 VLAN1
exit
show vlan brief
Max. VLAN ID..... 4042
Max. supported VLANs..... 16
Number of currently configured VLANs..... 3
vlan unaware mode..... disabled
VLAN ID VLAN Name          VLAN Type  VLAN Creation Time
-----
1      VLAN1                default   0 days, 00:00:05
2      VLAN2                static    0 days, 02:44:29
3      VLAN3                static    0 days, 02:52:26
```

Change to the Privileged EXEC mode.
Change to the VLAN configuration mode.
Creates a new VLAN with the VLAN ID 2.
Assign the name 2 to the VLAN VLAN2.
Creates a new VLAN with the VLAN ID 3.
Assign the name 3 to the VLAN VLAN3.
Assign the name 1 to the VLAN VLAN1.
Change to the Privileged EXEC mode.
Display the current VLAN configuration.

Setting up the ports

- Open the *Switching > VLAN > Port* dialog.
- To assign the port to a VLAN, specify the desired value in the corresponding column.
Possible values:
 - ▶ T = The port is a member of the VLAN. The port transmits tagged data packets.
 - ▶ U = The port is a member of the VLAN. The port transmits untagged data packets.
 - ▶ F = The port is not a member of the VLAN.
 - ▶ - = The port is not a member of this VLAN.
- Because end devices usually interpret untagged data packets, you specify the value U.
- To save the changes temporarily, click the button.
- Open the *Switching > VLAN > Port* dialog.
- In the *Port-VLAN ID* column, specify the VLAN ID of the related VLAN:
2 or 3

- Because end devices usually interpret untagged data packets, in the *Acceptable packet types* column, you specify the value `admitAll` for end device ports.
- To save the changes temporarily, click the button.

The value in the *Ingress filtering* column has no affect on how this example functions.

```
enable
configure
interface 1/1
vlan participation include 2

vlan pvid 2
exit
interface 1/2
vlan participation include 3

vlan pvid 3
exit
interface 1/3
vlan participation include 3

vlan pvid 3
exit
interface 1/4
vlan participation include 2

vlan pvid 2
exit
exit
show vlan id 3
VLAN ID          : 3
VLAN Name        : VLAN3
VLAN Type        : Static
Interface        Current   Configured   Tagging
-----
1/1              -       Autodetect   Tagged
1/2              Include  Include      Untagged
1/3              Include  Include      Untagged
1/4              -       Autodetect   Tagged
1/5              -       Autodetect   Tagged
```

Change to the Privileged EXEC mode.
Change to the Configuration mode.
Change to the interface configuration mode of interface 1/1.
The port 1/1 becomes a member of the VLAN 2 and transmits the data packets without a VLAN tag.
Assign the port VLAN ID 1/1 to port 2.
Change to the Configuration mode.
Change to the interface configuration mode of interface 1/2.
The port 1/2 becomes a member of the VLAN 3 and transmits the data packets without a VLAN tag.
Assign the port VLAN ID 1/2 to port 3.
Change to the Configuration mode.
Change to the interface configuration mode of interface 1/3.
The port 1/3 becomes a member of the VLAN 3 and transmits the data packets without a VLAN tag.
Assign the port VLAN ID 1/3 to port 3.
Change to the Configuration mode.
Change to the interface configuration mode of interface 1/4.
The port 1/4 becomes a member of the VLAN 2 and transmits the data packets without a VLAN tag.
Assign the port VLAN ID 1/4 to port 2.
Change to the Configuration mode.
Change to the Privileged EXEC mode.
Displays details for VLAN 3.

11.1.2 Example 2

The second example displays a more complex configuration with 3 VLANs (1 to 3). Along with the Switch from example 1, you use a 2nd Switch (on the right in the example).

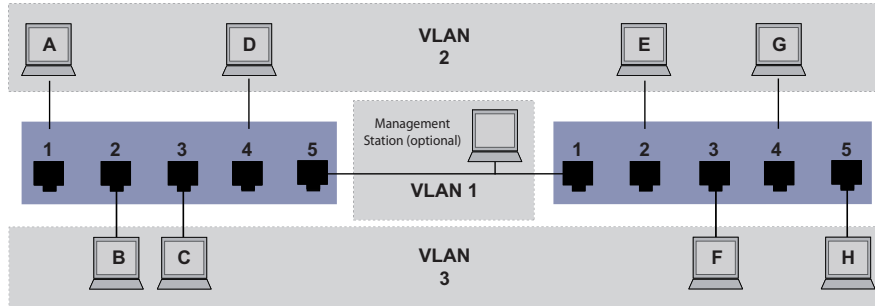

Figure 24: Example of a more complex VLAN configuration

The terminal devices of the individual VLANs (A to H) are spread over 2 transmission devices (Switches). Such VLANs are therefore known as distributed VLANs. An optional network management station is also shown, which enables access to every network component if the VLAN is configured correctly.

Note: In this case, VLAN 1 has no significance for the end device communication, but it is required for the administration of the transmission devices via what is known as the Management VLAN.

As in the previous example, uniquely assign the ports with their connected terminal devices to a VLAN. With the direct connection between the 2 transmission devices (uplink), the ports transport packets for both VLANs. To differentiate these uplinks you use “VLAN tagging”, which handles the data packets accordingly. Thus, you maintain the assignment to the respective VLANs.

Perform the following steps:

- Add Uplink Port 5 to the ingress and egress tables from example 1.
- Create new ingress and egress tables for the right switch, as described in the first example.

The egress table specifies on which ports the device sends the packets from this VLAN.

- ▶ T = Tagged (with a tag field, marked)
- ▶ U = Untagged (without a tag field, unmarked)

In this example, tagged packets are used in the communication between the transmission devices (Uplink), as packets for different VLANs are differentiated at these ports.

| Terminal | Port | Port VLAN identifier (PVID) |
|----------|------|-----------------------------|
| A | 1 | 2 |
| B | 2 | 3 |
| C | 3 | 3 |
| D | 4 | 2 |
| Uplink | 5 | 1 |

Table 15: Ingress table for device on left

| Terminal | Port | Port VLAN identifier (PVID) |
|----------|------|-----------------------------|
| Uplink | 1 | 1 |
| E | 2 | 2 |
| F | 3 | 3 |
| G | 4 | 2 |
| H | 5 | 3 |

Table 16: Ingress table for device on right

| VLAN ID | Port | | | | |
|---------|------|---|---|---|---|
| | 1 | 2 | 3 | 4 | 5 |
| 1 | | | | | U |
| 2 | U | | | U | T |
| 3 | | U | U | | T |

Table 17: Egress table for device on left

| VLAN ID | Port | | | | |
|---------|------|---|---|---|---|
| | 1 | 2 | 3 | 4 | 5 |
| 1 | U | | | | |
| 2 | T | U | | U | |
| 3 | T | | U | | U |

Table 18: Egress table for device on right

The communication relationships here are as follows: end devices on ports 1 and 4 of the left device and end devices on ports 2 and 4 of the right device are members of VLAN 2 and can thus communicate with each other. The behavior is the same for the end devices on ports 2 and 3 of the left device and the end devices on ports 3 and 5 of the right device. These belong to VLAN 3.

The end devices “see” their respective part of the network. Participants outside this VLAN cannot be reached. The device also sends Broadcast, Multicast, and Unicast packets with unknown (unlearned) destination addresses exclusively inside a VLAN.

Here, the devices use VLAN tagging (IEEE 801.1Q) within the VLAN with the ID 1 (Uplink). The letter T in the egress table of the ports indicates VLAN tagging.

The configuration of the example is the same for the device on the right. Proceed in the same way, using the ingress and egress tables created above to adapt the previously configured left device to the new environment.

Perform the following steps:

□ Setting up the VLAN

- Open the *Switching > VLAN > Configuration* dialog.
- Click the  button.
The dialog displays the *Create* window.
- In the *VLAN ID* field, specify the VLAN ID, for example 2.
- Click the *Ok* button.
- For the VLAN, specify the name VLAN2:
Double-click in the *Name* column and specify the name.
For VLAN 1, in the *Name* column, change the value *Default* to VLAN1.
- Repeat the previous steps to create a VLAN 3 with the name VLAN3.

```

enable
vlan database
vlan add 2
name 2 VLAN2
vlan add 3
name 3 VLAN3
name 1 VLAN1
exit
show vlan brief
Max. VLAN ID..... 4042
Max. supported VLANs..... 16
Number of currently configured VLANs..... 3
vlan unaware mode..... disabled
VLAN ID VLAN Name                VLAN Type VLAN Creation Time
-----
1          VLAN1                default   0 days, 00:00:05
2          VLAN2                static    0 days, 02:44:29
3          VLAN3                static    0 days, 02:52:26

```

Change to the Privileged EXEC mode.
Change to the VLAN configuration mode.
Creates a new VLAN with the VLAN ID 2.
Assign the name 2 to the VLAN VLAN2.
Creates a new VLAN with the VLAN ID 3.
Assign the name 3 to the VLAN VLAN3.
Assign the name 1 to the VLAN VLAN1.
Change to the Privileged EXEC mode.
Display the current VLAN configuration.

□ Setting up the ports

- Open the *Switching > VLAN > Port* dialog.
- To assign the port to a VLAN, specify the desired value in the corresponding column.
Possible values:
 - ▶ T = The port is a member of the VLAN. The port transmits tagged data packets.
 - ▶ U = The port is a member of the VLAN. The port transmits untagged data packets.
 - ▶ F = The port is not a member of the VLAN.
 - ▶ - = The port is not a member of this VLAN.

Because end devices usually interpret untagged data packets, you specify the value U.
You specify the T setting on the uplink port on which the VLANs communicate with each other.
- To save the changes temporarily, click the button.
- Open the *Switching > VLAN > Port* dialog.
- In the *Port-VLAN ID* column, specify the VLAN ID of the related VLAN:
1, 2 or 3
- Because end devices usually interpret untagged data packets, in the *Acceptable packet types* column, you specify the value `admitAll` for end device ports.
- For the uplink port, in the *Acceptable packet types* column, specify the value `admitOnlyVlanTagged`.
- Mark the checkbox in the *Ingress filtering* column for the uplink ports to evaluate VLAN tags on this port.
- To save the changes temporarily, click the button.

```

enable
configure
interface 1/1
vlan participation include 1

vlan participation include 2

vlan tagging 2 enable

vlan participation include 3

vlan tagging 3 enable

vlan pvid 1
vlan ingressfilter

```

Change to the Privileged EXEC mode.
Change to the Configuration mode.
Change to the interface configuration mode of interface 1/1.
The port 1/1 becomes a member of the VLAN 1 and transmits the data packets without a VLAN tag.
The port 1/1 becomes a member of the VLAN 2 and transmits the data packets without a VLAN tag.
The port 1/1 becomes a member of the VLAN 2 and transmits the data packets with a VLAN tag.
The port 1/1 becomes a member of the VLAN 3 and transmits the data packets without a VLAN tag.
The port 1/1 becomes a member of the VLAN 3 and transmits the data packets with a VLAN tag.
Assigning the Port VLAN ID 1 to port 1/1.
Activate ingress filtering on port 1/1.

VLANs

11.1 Examples of VLANs

```
vlan acceptframe vlanonly
exit
interface 1/2
vlan participation include 2
```

```
vlan pvid 2
exit
interface 1/3
vlan participation include 3
```

```
vlan pvid 3
exit
interface 1/4
vlan participation include 2
```

```
vlan pvid 2
exit
interface 1/5
vlan participation include 3
```

```
vlan pvid 3
exit
exit
show vlan id 3
VLAN ID.....3
VLAN Name.....VLAN3
VLAN Type.....Static
VLAN Creation Time.....0 days, 00:07:47 (System Uptime)
VLAN Routing.....disabled
```

| Interface | Current | Configured | Tagging |
|-----------|---------|------------|----------|
| 1/1 | Include | Include | Tagged |
| 1/2 | - | Autodetect | Untagged |
| 1/3 | Include | Include | Untagged |
| 1/4 | - | Autodetect | Untagged |
| 1/5 | Include | Include | Untagged |

Port 1/1 only forwards packets with a VLAN tag.
 Change to the Configuration mode.
 Change to the interface configuration mode of interface 1/2.
 The port 1/2 becomes a member of the VLAN 2 and transmits the data packets without a VLAN tag.
 Assigning the Port VLAN ID 2 to port 1/2.
 Change to the Configuration mode.
 Change to the interface configuration mode of interface 1/3.
 The port 1/3 becomes a member of the VLAN 3 and transmits the data packets without a VLAN tag.
 Assigning the Port VLAN ID 3 to port 1/3.
 Change to the Configuration mode.
 Change to the interface configuration mode of interface 1/4.
 The port 1/4 becomes a member of the VLAN 2 and transmits the data packets without a VLAN tag.
 Assigning the Port VLAN ID 2 to port 1/4.
 Change to the Configuration mode.
 Change to the interface configuration mode of interface 1/5.
 The port 1/5 becomes a member of the VLAN 3 and transmits the data packets without a VLAN tag.
 Assigning the Port VLAN ID 3 to port 1/5.
 Change to the Configuration mode.
 Change to the Privileged EXEC mode.
 Displays details for VLAN 3.

11.2 Guest / Unauthenticated VLAN

The guest VLAN function allows a device to provide port-based Network Access Control (IEEE 802.1x) to non-802.1x capable supplicants. This feature provides a mechanism to allow guests to access external networks exclusively. When you connect non-802.1x capable supplicants to an active unauthorized 802.1x port, the supplicants send no responses to 802.1x requests. Since the supplicants send no responses, the port remains in the unauthorized state. The supplicants have no access to external networks.



The guest VLAN supplicant function is a per-port basis configuration. When you configure a port as a guest VLAN and connect non-802.1x capable supplicants to this port, the device assigns the supplicants to the guest VLAN. Adding supplicants to a guest VLAN causes the port to change to the authorized state allowing the supplicants to access to external networks.

The Unauthenticated VLAN function allows the device to provide service to 802.1x capable supplicants which authenticate incorrectly. This function allows the unauthorized supplicants to have access to limited services. When you configure an unauthenticated VLAN on a port with 802.1x port authentication and the global operation enabled, the device places the port in an unauthenticated VLAN. When a 802.1x capable supplicant incorrectly authenticates on the port, the device adds the supplicant to the unauthenticated VLAN. If you also configure a guest VLAN on the port, then non-802.1x capable supplicants use the guest VLAN.

The reauthentication timer counts down when the port has an unauthenticated VLAN assigned. The unauthenticated VLAN reauthenticates when the time specified in the *Reauthentication period [s]* column expires and supplicants are present on the port. If no supplicants are present, the device places the port in the configured guest VLAN.

The following example explains how to create a Guest VLAN. Create an Unauthorized VLAN in the same manner.

Perform the following steps:

- Open the *Switching > VLAN > Configuration* dialog.
- Click the  button.
The dialog displays the *Create* window.
- In the *VLAN ID* field, specify the value 10.
- Click the *Ok* button.
- For the VLAN, specify the name *Guest*:
Double-click in the *Name* column and specify the name.
- Click the  button.
The dialog displays the *Create* window.
- In the *VLAN ID* field, specify the value 20.
- Click the *Ok* button.
- For the VLAN, specify the name *Not authorized*:
Double-click in the *Name* column and specify the name.
- Open the *Network Security > 802.1X Port Authentication > Global* dialog.
- To enable the function, select the *On* radio button in the *Operation* frame.
- To save the changes temporarily, click the button.
- Open the *Network Security > 802.1X Port Authentication > Port Configuration* dialog.

- Specify the following settings for port 1/4:
 - The value `auto` in the *Port control* column
 - The value `10` in the *Guest VLAN ID* column
 - The value `20` in the *Unauthenticated VLAN ID* column
- To save the changes temporarily, click the button.

```
enable
vlan database
vlan add 10
vlan add 20
name 10 Guest
name 20 Unauth
exit
configure
dot1x system-auth-control enable
dot1x port-control auto
interface 1/4
dot1x guest-vlan 10
dot1x unauthenticated-vlan 20
exit
```

Change to the Privileged EXEC mode.
Change to the VLAN configuration mode.
Creates VLAN 10.
Creates VLAN 20.
Renames VLAN 10 to Guest.
Renames VLAN 20 to Unauth.
Change to the Privileged EXEC mode.
Change to the Configuration mode.
Enable the 802.1X function globally.
Enables port control on port 1/4.
Change to the interface configuration mode of interface 1/4.
Assign the guest vlan to port 1/4.
Assign the unauthorized vlan to port 1/4.
Change to the Configuration mode.

11.3 RADIUS VLAN assignment

The RADIUS VLAN assignment feature allows for a RADIUS VLAN ID attribute to be associated with an authenticated client. When a client authenticates successfully, and the RADIUS server sends a VLAN attribute, the device associates the client with the RADIUS assigned VLAN. As a result, the device adds the physical port as an untagged member to the appropriate VLAN and sets the port VLAN ID (PVID) with the given value.

11.4 Creating a Voice VLAN

Use the Voice VLAN feature to separate voice and data traffic on a port, by VLAN and/or priority. A primary benefit of using Voice VLAN is to safeguard the sound quality of an IP phone when the data traffic on the port is high.

The device uses the source MAC address to identify and prioritize the voice data flow. Using a MAC address to identify devices helps prevent a rogue client from connecting to the same port causing the voice traffic to deteriorate.

Another benefit of the Voice VLAN feature is that a VoIP phone obtains a VLAN ID or priority information using LLDP-MED. As a result, the VoIP phone sends voice data as tagged, priority tagged or untagged. This depends on the Voice VLAN Interface configuration.

The following Voice VLAN interface modes are possible. The first 3 methods segregate and prioritize voice and data traffic. Traffic segregation results in an increased voice traffic quality during high traffic periods.

- ▶ Configuring the port to using the `vlan` mode allows the device to tag the voice data coming from a VoIP phone with the user-defined voice VLAN ID. The device assigns regular data to the default port VLAN ID.
- ▶ Configuring the port to use the `dot1p-priority` mode allows the device to tag the data coming from a VoIP phone with VLAN 0 and the user-defined priority. The device assigns the default priority of the port to regular data.
- ▶ Configure both the voice VLAN ID and the priority using the `vlan/dot1p-priority` mode. In this mode the VoIP phone sends voice data with the user-defined voice VLAN ID and priority information. The device assigns the default PVID and priority of the port to regular data.
- ▶ When configured as `untagged`, the phone sends untagged packets.
- ▶ When configured as `none`, the phone uses its own configuration to send voice traffic.

11.5 VLAN unaware mode

The VLAN-unaware function defines the operation of the device in a LAN segmented by VLANs. The device accepts packets and processes them according to its inbound rules. Based on the IEEE 802.1Q specifications, the function governs how the device processes VLAN tagged packets.

Use the VLAN aware mode to apply the user-defined VLAN topology configured by the network administrator. The device uses VLAN tagging in combination with the IP or Ethernet address when forwarding packets. The device processes inbound and outbound packets according to the defined rules. VLAN configuration is a manual process.

Use the VLAN unaware mode to forward traffic as received, without any modification. The device transmits tagged packets when received as tagged. The device transmits also transmits untagged packets when received as untagged. Regardless of VLAN assignment mechanisms, the device assigns packets to VLAN ID 1 and to a Multicast group, indicating that the packet flood domain is according to the VLAN.

12 Redundancy

12.1 Network Topology vs. Redundancy Protocols

When using Ethernet, an important prerequisite is that data packets follow a single (unique) path from the sender to the receiver. The following network topologies support this prerequisite:

- ▶ Line topology
- ▶ Star topology
- ▶ Tree topology

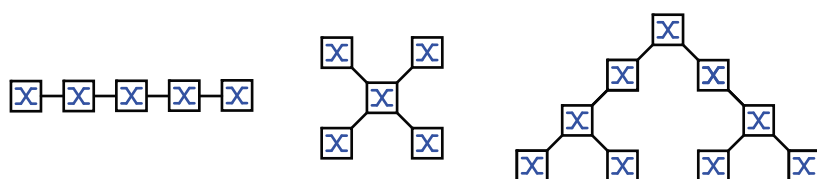

Figure 25: Network with line, star and tree topologies

To ensure that the communication is maintained when a connection fails, you install additional physical connections between the network nodes. Redundancy protocols ensure that the additional connections remain switched off while the original connection is still working. If the connection fails, the redundancy protocol generates a new path from the sender to the receiver via the alternative connection.

To introduce redundancy onto Layer 2 of a network, you first define which network topology you require. Depending on the network topology selected, you then choose from the redundancy protocols that can be used with this network topology.

12.1.1 Network topologies

■ Meshed topology

For networks with star or tree topologies, redundancy procedures are only possible in connection with physical loop creation. The result is a meshed topology.

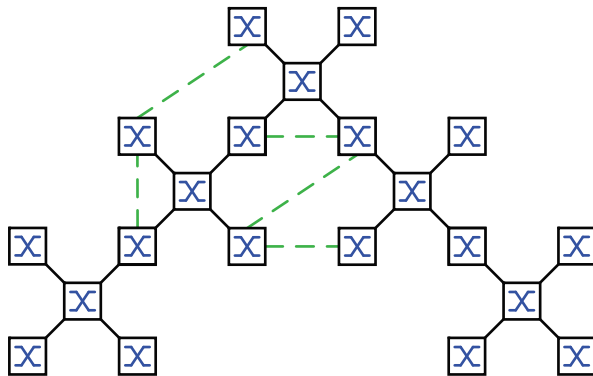

Figure 26: Meshed topology: Tree topology with physical loops

For operating in this network topology, the device provides you with the following redundancy protocols:

- ▶ Rapid Spanning Tree (RSTP)

■ Ring topology

In networks with a line topology, you can use redundancy procedures by connecting the ends of the line. This creates a ring topology.

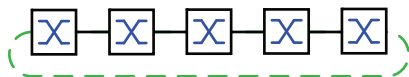

Figure 27: Ring topology: Line topology with connected ends

For operating in this network topology, the device provides you with the following redundancy protocols:

- ▶ Media Redundancy Protocol (MRP)
- ▶ High-availability Seamless Redundancy (HSR)
- ▶ Rapid Spanning Tree (RSTP)

12.1.2 Redundancy Protocols

For operating in different network topologies, the device provides you with the following redundancy protocols:

| Redundancy protocol | Network topology | Comments |
|---------------------|----------------------------------|--|
| MRP | Ring | The switching time can be selected and is practically independent of the number of devices. An MRP-Ring consists of up to 50 devices that support the MRP protocol according to IEC 62439. If you only use Hirschmann devices, up to 100 devices are possible in the MRP-Ring. |
| Fast MRP | Ring | The devices with hardware for enhanced redundancy functions offer the short failover times 30ms and 10ms. |
| DLR | Ring | Implementation in EtherNet/IP end-devices that have 2 Ethernet ports and embedded Layer 2 switch technology. The DLR protocol provides network fault detection and reconfiguration to support demanding control applications. |
| PRP | Random structure of the PRP LANs | Uninterrupted availability. On the path from the sender to the receiver, PRP transports a data packet in parallel via 2 mutually independent LANs. |
| HSR | Ring | Uninterrupted availability. On the path from the sender to the receiver, HSR transports the data packets in both directions via a ring. |
| RSTP | Random structure | The switching time depends on the network topology and the number of devices. ▶ typ. < 1 s with RSTP ▶ typ. < 30 s with STP |
| Link Aggregation | Random structure | A Link Aggregation Group is the combining of 2 or more, full-duplex point-to-point links operating at the same rate, on a single switch to increase bandwidth. |
| Link Backup | Random structure | When the device detects an error on the primary link, then the device transfers traffic to the backup link. You typically use Link Backup in service-provider or enterprise networks. |

Table 19: Overview of redundancy protocols

Note: When you are using a redundancy function, you deactivate the flow control on the participating device ports. If the flow control and the redundancy function are active at the same time, there is a risk that the redundancy function will not operate as intended.

12.1.3 Combinations of Redundancies

| | MRP | RSTP/ MSTP | Link Aggreg. | Link Backup | Subring | HIPER Ring | Fast MRP | DLR | HSR | PRP |
|-----------------------------|-----------------|-----------------|-----------------|----------------|---------|---------------|----------|-----|-----|-----|
| MRP | ✓ | | | | | | | | | |
| RSTP/ MSTP ³⁾ | ✓ ¹⁾ | ✓ | | | | | | | | |
| Link Aggreg. | ✓ ⁴⁾ | ✓ ⁴⁾ | ✓ | | | | | | | |
| Link Backup | ✓ | ✓ | ✓ | ✓ | | | | | | |
| Fast MRP ²⁾ | | ✓ ¹⁾ | ✓ | ✓ | | | ✓ | | | |
| DLR ²⁾ | ✓ ¹⁾ | ✓ ¹⁾ | ✓ | ✓ | | | | ✓ | | |

Table 20: Overview of redundancy protocols

| | MRP | RSTP/ MSTP | Link Aggreg. | Link Backup | Subring | HIPER Ring | Fast MRP | DLR | HSR | PRP |
|-------------------|-----|-----------------|-----------------|----------------|---------|---------------|----------|-----|-----------------|-----------------|
| HSR ²⁾ | ✓ | ✓ ¹⁾ | ✓ | ✓ | | | | | ✓ ²⁾ | |
| PRP ²⁾ | ✓ | ✓ ¹⁾ | ✓ | ✓ | | | | | A | ✓ ²⁾ |

Table 20: Overview of redundancy protocols (cont.)

| Symbol | Meaning |
|--------|---|
| ✓ | Combination applicable |
| A | HSR/PRP coupling: Same PRP ID on every non-HSR port. |
| 1) | Redundant coupling between these network topologies will possibly lead to data loops. |
| 2) | Available only on port 1 and port 2. |
| 3) | In combination with MSTP, the failover times of other redundancy protocols may slightly increase. |
| 4) | Combination applicable on the same port |

12.2 Media Redundancy Protocol (MRP)

Since May 2008, the Media Redundancy Protocol (MRP) has been a standardized solution for ring redundancy in the industrial environment.

MRP is compatible with redundant ring coupling, supports VLANs, and is distinguished by very short reconfiguration times.

An MRP-Ring consists of up to 50 devices that support the MRP protocol according to IEC 62439. If you only use Hirschmann devices, up to 100 devices are possible in the MRP-Ring.

You use the fixed MRP redundant port (Fixed Backup) if the primary ring link fails, the Ring Manager sends data traffic to the secondary ring link. When the primary link is restored, the secondary link continues to be in use.

12.2.1 Network Structure

The concept of ring redundancy allows the construction of high-availability, ring-shaped network structures.

With the help of the RM (**R**ing **M**anager) function, the two ends of a backbone in a line structure can be closed to a redundant ring. The Ring Manager keeps the redundant line open as long as the line structure is intact. If a segment becomes inoperable, the Ring Manager immediately closes the redundant line, and line structure is intact again.

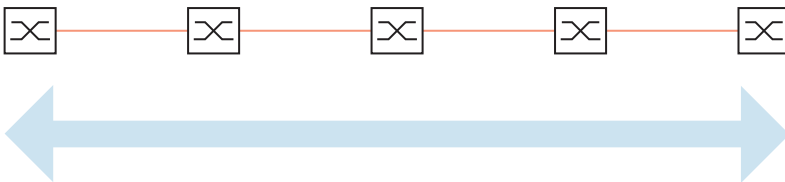

Figure 28: Line structure

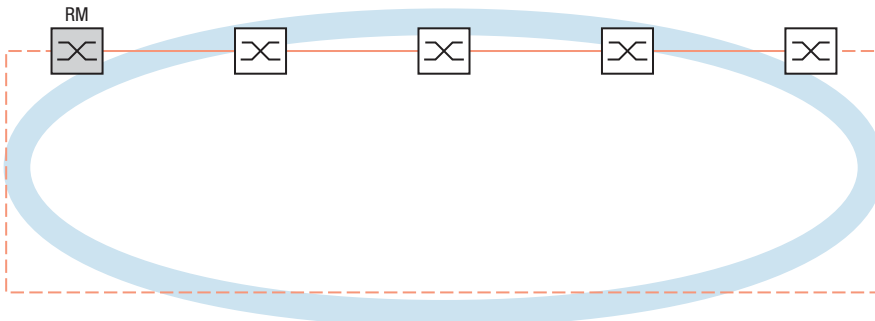

Figure 29: Redundant ring structure

RM = Ring Manager
— main line
- - - redundant line

12.2.2 Reconfiguration time

If a line section fails, the Ring Manager changes the MRP-Ring back into a line structure. You define the maximum time for the reconfiguration of the line in the Ring Manager.

Possible values for the maximum delay time:

- 500 ms
- 200 ms
- 30 ms
- 10 ms

The delay times 30ms and 10ms are solely available to you for devices with hardware for extended redundancy functions.

In order to use these fast delay times, load the Fast MRP device software.

Set the delay time solely to 10ms, when you use up to 20 devices in the ring that support this delay time. If you use more than 20 of these devices in the ring, set the delay time to at least 30ms.

Note: You only configure the reconfiguration time with a value less than 500 ms if all the devices in the ring support the shorter delay time.

Otherwise the devices that only support longer delay times might not be reachable due to overloading. Loops can occur as a result.

12.2.3 Advanced mode

For times even shorter than the guaranteed reconfiguration times, the device provides the advanced mode. The advanced mode speeds up the link failure recognition when the ring participants inform the Ring Manager of interruptions in the ring via link-down notifications.

Hirschmann devices support link-down notifications. Therefore, you generally activate the advanced mode in the Ring Manager.

If you are using devices that do not support link-down notifications, the Ring Manager reconfigures the line in the selected maximum reconfiguration time.

12.2.4 Prerequisites for MRP

Before setting up an MRP-Ring, make sure that the following conditions are fulfilled:

- ▶ All ring participants support MRP.
- ▶ The ring participants are connected to each other via the ring ports. Apart from the device's neighbors, no other ring participants are connected to the respective device.
- ▶ All ring participants support the configuration time specified in the Ring Manager.
- ▶ There is exactly 1 Ring Manager in the ring.

If you are using VLANs, configure every ring port with the following settings:

- Deactivate ingress filtering - see the *Switching > VLAN > Port* dialog.
- Define the port VLAN ID (PVID) - see the *Switching > VLAN > Port* dialog.
 - PVID = 1 if the device transmits the MRP data packets untagged (VLAN ID = 0 in *Switching > L2-Redundancy > MRP* dialog)
By setting the PVID = 1, the device automatically assigns the received untagged packets to VLAN 1.
 - PVID = any if the device transmits the MRP data packets in a VLAN (VLAN ID ≥ 1 in the *Switching > L2-Redundancy > MRP* dialog)
- Define egress rules - see *Switching > VLAN > Configuration* dialog.
 - U (untagged) for the ring ports of VLAN 1 if the device transmits the MRP data packets untagged (VLAN ID = 0 in the *Switching > L2-Redundancy > MRP* dialog, the MRP ring is not assigned to a VLAN).
 - T (tagged) for the ring ports of the VLAN which you assign to the MRP ring. Select T, if the device transmits the MRP data packets in a VLAN (VLAN ID ≥ 1 in the *Switching > L2-Redundancy > MRP* dialog).

12.2.5 Example Configuration

A backbone network contains 3 devices in a line structure. To increase the availability of the network, you convert the line structure to a redundant ring structure. Devices from different manufacturers are used. All devices support MRP. On every device you define ports 1.1 and 1.2 as ring ports.

If the primary ring link fails, the Ring Manager sends data on the secondary ring link. When the primary link is restored, the secondary link reverts back to the backup mode.

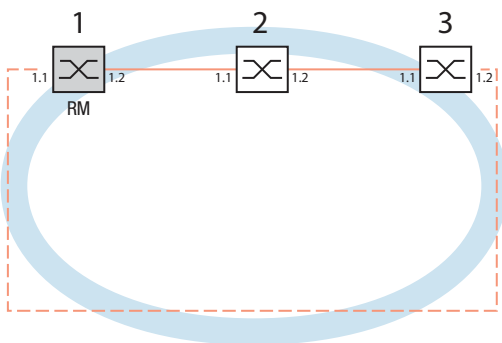

Figure 30: Example of MRP-Ring
RM = Ring Manager
— main line
- - - redundant line

The following example configuration describes the configuration of the Ring Manager device (1). You configure the 2 other devices (2 to 3) in the same way, but without activating the Ring Manager function. This example does not use a VLAN. You specify 200 ms as the ring recovery time. Every device supports the advanced mode of the Ring Manager.

- Set up the network to meet your demands.
- Configure all ports so that the transmission speed and the duplex settings of the lines correspond to the following table:

| Port type | Bit rate | Autonegotiation (automatic configuration) | Port setting | Duplex |
|-----------|------------|---|--------------|------------------------------|
| TX | 100 Mbit/s | off | on | 100 Mbit/s full duplex (FDX) |
| TX | 1 Gbit/s | on | on | - |
| Optical | 100 Mbit/s | off | on | 100 Mbit/s full duplex (FDX) |
| Optical | 1 Gbit/s | on | on | - |
| Optical | 10 Gbit/s | - | on | 10 Gbit/s full duplex (FDX) |

Table 21: Port settings for ring ports

Note: You configure optical ports without support for autonegotiation (automatic configuration) with 100 Mbit/s full duplex (FDX) or 1000 Mbit/s full duplex (FDX).

Note: You configure optical ports without support for autonegotiation (automatic configuration) with 100 Mbit/s full duplex (FDX).

Note: Configure all the devices of the MRP-Ring individually. Before you connect the redundant line, you must have completed the configuration of all the devices of the MRP-Ring. You thus avoid loops during the configuration phase.

- You deactivate the flow control on the participating ports.
If the flow control and the redundancy function are active at the same time, there is a risk that the redundancy function will not operate as intended. (Default setting: flow control deactivated globally and activated on all ports.)

- Switch Spanning Tree off on all devices in the network:

- Open the *Switching > L2-Redundancy > Spanning Tree > Global* dialog.
- Disable the function.
In the state on delivery, Spanning Tree is enabled on the device.

| | |
|----------------------------|---------------------------------------|
| enable | Change to the Privileged EXEC mode. |
| configure | Change to the Configuration mode. |
| no spanning-tree operation | Switches Spanning Tree off. |
| show spanning-tree global | Displays the parameters for checking. |

- Enable MRP on every device in the network:

- Open the *Switching > L2-Redundancy > MRP* dialog.
- Specify the desired ring ports.

Note: If the device uses the software supporting Fast MRP, you cannot select a *Link Aggregation* port as a ring port.

In the Command Line Interface you first define an additional parameter, the MRP domain ID. Configure all the ring participants with the same MRP domain ID. The MRP domain ID is a sequence of 16 number blocks (8-bit values).

When configuring with the graphical user interface, the device uses the default value 255 255 255 255 255 255 255 255 255 255 255 255 255 255.

```
mrp domain add default-domain          Creates a new MRP domain with the default domain ID.
mrp domain modify port primary 1/1     Specifies port 1/1 as ring port 1.
mrp domain modify port secondary 1/2   Specifies port 1/2 as ring port 2.
```

Enable the *Fixed backup* port.

Enable the Ring Manager.

For the other devices in the ring, leave the setting as *Off*.

To allow the device to continue sending data on the secondary port after the ring is restored, mark the *Fixed backup* checkbox.

Note: When the device reverts back to the primary port, the maximum ring recovery time may be exceeded.

If you unmark the *Fixed backup* checkbox, and the ring is restored, then the Ring Manager blocks the secondary port and unblocks the primary port.

```
mrp domain modify port secondary 1/2   Activates the Fixed backup function on the secondary port. The
fixed-backup enable                    secondary port continues forwarding data after the ring is
                                         restored.
```

Enable the Ring Manager.

For the other devices in the ring, leave the setting as *Off*.

```
mrp domain modify mode manager         Specifies that the device operates as the Ring manager. Do not
                                         activate the Ring manager function on any other device.
```

Select the checkbox in the *Advanced mode* field.

```
mrp domain modify advanced-mode enabled Activates the advanced mode.
```

In the *Ring recovery* field, select the value 200ms.

```
mrp domain modify recovery-delay 200ms Specifies the value 200ms as the max. delay time for the
                                         reconfiguration of the ring.
```

Note: If selecting 200 ms for the ring recovery does not provide the ring stability necessary to meet the requirements of your network, you select 500 ms.

Switch the operation of the MRP-Ring on.

To save the changes temporarily, click the button.

```
mrp domain modify operation enable     Activates the MRP-Ring.
```

When all the ring participants are configured, close the line to the ring. To do this, you connect the devices at the ends of the line via their ring ports.

Check the messages from the device:

```
show mrp                               Displays the parameters for checking.
```

The *Operation* field displays the operating state of the ring port.

Possible values:

- ▶ forwarding
The port is enabled, connection exists.
- ▶ blocked
The port is blocked, connection exists.
- ▶ disabled
The port is disabled.
- ▶ not-connected
No connection exists.

The *Information* field displays messages for the redundancy configuration and the possible causes of errors.

The following messages are possible if the device is operating as a ring client or a Ring Manager:

- ▶ *Redundancy available*
The redundancy is set up. When a component of the ring is down, the redundant line takes over its function.
- ▶ *Configuration error: Error on ringport link.*
Error in the cabling of the ring ports.

The following messages are possible if the device is operating as a Ring Manager:

- ▶ *Configuration error: Packets from another ring manager received.*
Another device exists in the ring that is operating as the Ring Manager. Activate the *Ring manager* function on exactly one device in the ring.
- ▶ *Configuration error: Ring link is connected to wrong port.*
A line in the ring is connected with a different port instead of with a ring port. The device only receives test data packets on 1 ring port.

If applicable, integrate the MRP ring into a VLAN:

- In the *VLAN ID* field, define the MRP VLAN ID. The MRP VLAN ID determines in which of the configured VLANs the device transmits the MRP packets. To set the MRP VLAN ID, first configure the VLANs and the corresponding egress rules in the *Switching > VLAN > Configuration* dialog.
- ▶ If the MRP-Ring is not assigned to a VLAN (like in this example), leave the VLAN ID as 0. In the *Switching > VLAN > Configuration* dialog, specify the VLAN membership as **U** (untagged) for the ring ports in VLAN 1.
- ▶ If the MRP-Ring is assigned to a VLAN, enter a VLAN ID >0. In the *Switching > VLAN > Configuration* dialog, specify the VLAN membership as **T** (tagged) for the ring ports in the selected VLAN.

```
mrp domain modify vlan <0..4042> Assigns the VLAN ID.
```

12.3 Device Level Ring (DLR)

The Device Level Ring (DLR) protocol is a Layer 2 protocol that provides redundancy for Ethernet data using a ring topology. The primary implementation for the DLR protocol is to control and monitor EtherNet/IP devices.

The DLR protocol operates at Layer 2 in the OSI model. The presence of the ring topology and the operation of the DLR protocol are transparent to higher layer protocols such as TCP/IP and EtherNet/IP. The DLR protocol is transparent with the exception of a DLR Object. The DLR Object provides a configuration and diagnostic interface for the EtherNet/IP protocol.

The DLR protocol also allows you to install non-DLR multi-port Layer 2 switches in the ring. Non-DLR Layer 2 switches are subject to certain restrictions. For example, the Layer 2 switch has the MAC table filtering disabled. Non-DLR devices have an impact on the ring recovery time.

In the delivery setting the function is disabled.

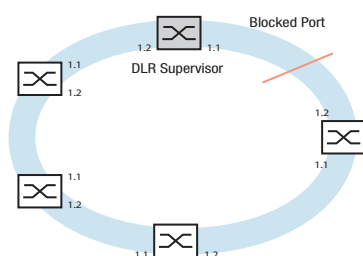

Figure 31: DLR Network with ring participants

12.3.1 Device Roles

A DLR network includes at least 1 ring supervisor, and a DLR capable ring participant. Every participant in the ring has at least 2 Ethernet ports, and implements Layer 2 switching technology. After a ring participant receives a packet on a ring port, it determines whether to process or forward the packet depending on the MAC address contained in the packet.

■ Active Ring Supervisor

The active ring supervisor is responsible for monitoring and controlling the network. To monitor the network the active ring supervisor uses Beacon and Announce packets. The Beacon packets contain configuration information that the active ring supervisor sends to the ring participants. The ring participants configure their DLR parameters with the information contained in the Beacon packets.

The following list contains the configuration information sent in the Beacon packet:

- ▶ Beacon interval
- ▶ Beacon timeout
- ▶ Supervisor Precedence, entered in the Beacon-based participant configuration only
- ▶ DLR VLAN ID

Note: The default VLAN ID used for DLR is 0. Verify that the *VLAN unaware mode* in the *Switching > Switching Global* dialog is activated.

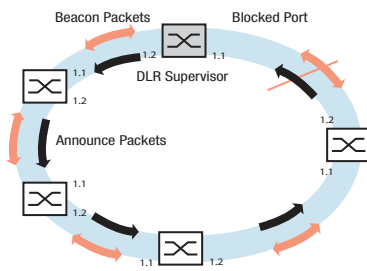

Figure 32: Beacon and Announce packets

An active ring supervisor boots in the `FAULT_STATE` and forwards Beacon and Announce packets on both Ethernet ports. During boot up the Beacon and Announce packets contain the value `RING_FAULT_STATE` as the ring state.

Once the active ring supervisor receives Beacon packets on both ports, it transitions the ring state to the `NORMAL_STATE`, sets a port to blocking, and flushes its unicast MAC address table. The active ring supervisor continues to send Beacon packets on both ports and sends Announce packets only on the unblocked port. By blocking a ring port, the active ring supervisor provides only 1 path for the ring participants to send and receive data. The active ring supervisor sends an Announce packet on the forwarding port, with the ring state set to `RING_NORMAL_STATE`.

Since the active ring supervisor is responsible for controlling and monitoring the ring, it needs to know who is on the ring. The active ring supervisor does this by initiating the `Sign_On` process.

■ Backup Supervisors

When the ring contains multiple supervisors, each supervisor sends Beacon packets during boot up. Besides ring state messages, and configuration information, the Beacon packets also contain a supervisor precedence value. When an active ring supervisor receives a Beacon packet, it checks the precedence value. If the precedence value in the Beacon packet is higher than its own, then the active ring supervisor transitions to the `FAULT_STATE` and assumes the backup supervisor role. If the precedence values are the same, then the ring supervisor with the numerically higher MAC address assumes the role of the active ring supervisor.

The backup supervisors configure their DLR parameters, except for the supervisor precedence value, and the DLR VLAN ID with the information contained in the Beacon packets. The backup supervisors continue to monitor both ports for a timeout of the Beacon packets. If the backup supervisor times out the Beacon packets on both ports, then it waits an extra Beacon Timeout period before sending its Beacon packets.

■ Beacon-based Nodes

When the supervisor function on a ring participant is inactive, then it assumes the role of a Beacon-based participant. Beacon-based participants process both Beacon packets and Announce packets. This allows a quicker response to detected ring breaks.

A Beacon-based ring participant boots up in the `IDLE_STATE`, and presumes the network is a linear topology. Upon receiving a Beacon packet on either the primary or the secondary port, the participant transitions to the `FAULT_STATE`, and presumes the network is a ring topology. The ring participant flushes its unicast MAC address table and saves the DLR parameters received in the Beacon packets.

The ring participants save the following DLR parameters in their configuration:

- ▶ Supervisor addresses, MAC and IP address
- ▶ Supervisor precedence
- ▶ Beacon interval
- ▶ Beacon timeout
- ▶ DLR VLAN ID

Upon receiving the Beacon packets on both ports, the ring participant transitions to the NORMAL_STATE. Then the ring participant flushes its unicast MAC address table.

■ Non-DLR Nodes

The DLR protocol does not require that every ring participant implement the protocol. The network administrator can install non-DLR participants in the ring. This assumes that the devices support certain required configurations.

Note: Using non-DLR participants in the ring lengthens the recovery time. When possible, connect the non-DLR participants to the ring through a DLR capable device.

When installing non-DLR participants directly in the ring, the participants require certain configurations. The following list describes the configurations required:

- ▶ Disable unicast MAC address learning.
Beacon packets arrive on both ports with the MAC address of the active ring supervisor. Address learning causes the MAC address of the active ring supervisor to bounce from port to port.
- ▶ Disable multicast filtering on DLR ring ports.
The Beacon and Announce packets used in the DLR protocol are multicast messages. If unsupported, then the participant filters out the DLR messages.
- ▶ Support the reception of 802.1Q packets and preservation of the VLAN ID and tag priority.
If unsupported, then the device can drop or improperly queue the DLR messages.
- ▶ Implement priority queues with strict priority scheduling.
Assign the DLR messages the highest priority queue. If unsupported, then the device delays DLR messages which affects ring recovery performance.

Note: Using non-DLR participants can result in loss of unicast packets for some time following a detected error or ring restoration. If the non-DLR participant maintains the MAC address table after a detected error, then the participant can send unicast packets on the wrong port. For this reason, DLR capable participants flush their MAC address table.

12.3.2 Error Detection

The active ring supervisor is responsible for ring integrity. In order to control and monitor the ring, the active ring supervisor sends Beacon and Announce packets. The Beacon and Announce packets contain various status messages. The status messages inform the ring participants about the health of the ring.

The ring participants also monitor connections to their neighbors. When a ring participant detects that the link to a neighbor is down, it sends a Link_Status message to the active ring supervisor.

After receipt of the Link_Status message, the ring supervisor unblocks its previously blocked port. Unblocking the port transitions the network from a ring to a linear topology. The active ring supervisor then flushes its unicast MAC table, and immediately sends Beacon and Announce packets. The ring state set to RING_FAULT_STATE.

■ Active Ring Supervisor

The following list contains events in which the active ring supervisor transitions to the FAULT_STATE:

- ▶ Receiving Beacon packets from another supervisor with a higher precedence value.
- ▶ Loss of Beacon packets on either port for the specified Beacon Timeout period, indicating a break somewhere in the ring.
- ▶ Loss of link with the neighboring participant detected on either port.
- ▶ Receiving a Link_Status message from a ring participant, indicating that a ring participant has detected an error.

In the cases listed above, the active ring supervisor responds with the following actions:

- ▶ Transition to FAULT_STATE
- ▶ Flush the unicast MAC address table
- ▶ Unblock the blocked port
- ▶ Send Beacon packets out both ports, with ring state set to the RING_FAULT_STATE
- ▶ Send Announce packets out both ports, with ring state set to the RING_FAULT_STATE

When the active ring supervisor times out a Beacon packet, it initiates the Neighbor Check process by sending a Locate Fault packet. The supervisor also sends Neighbor Check packets to the neighbor connected to the ports on which it timed out the Beacon packet.

When in the FAULT_STATE, the active ring supervisor continues to send Beacon packets. Sending Beacon packets allows the active ring supervisor to detect ring restoration.

■ Ring Participants

The following list contains events in which the ring participant transitions from the NORMAL_STATE:

- ▶ Receipt of a Beacon packet with the ring state set to RING_FAULT_STATE.
- ▶ Receipt of a Beacon packet with a different MAC address and higher precedence than the current active ring supervisor.
- ▶ Loss of Beacon packets on both ports for the specified Beacon Timeout period. Losing the Beacon packets on both ports causes the participant to transition to IDLE_STATE. The ring participant assumes that the topology has transitioned from a ring to a linear network.
- ▶ Loss of Beacon packets on a single port for the specified Beacon Timeout period.

In the cases listed above, the ring participant responds with the following actions:

- ▶ Flush the unicast MAC address table
- ▶ A loss of Beacon packets on both ports or the loss of Announce packets causes the ring participant to transition to the IDLE_STATE.
- ▶ A loss of Beacon packets on a single port causes the ring participant to transition to the FAULT_STATE.

12.3.3 Neighbor Check process

When the active ring supervisor detects the loss of Beacon packets, it sends a Locate_Fault packet to the ring participants through both ports.

Upon receipt of the Locate_Fault packet, each ring participant sends a Neighbor_Check_Request packet to its immediate neighbors. The supervisor also sends its own Neighbor_Check_Request to its immediate neighbors.

When the ring participants receives a Neighbor_Check_Request packet, it responds with a Neighbor_Check_Response packet on the port from which it received the request. If the participant sending the Neighbor_Check_Request does not receive a response, it sends another request. If the participant receives no responses after 3 attempts, then it sends a Neighbor_Status packet to the ring supervisor.

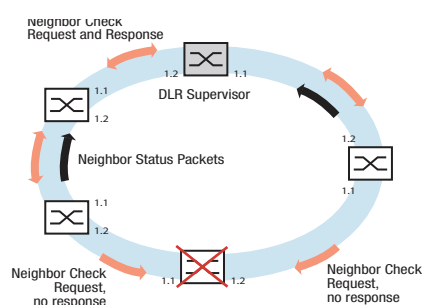

Figure 33: Neighbor Check process

12.3.4 Sign On Process

To identify ring participants, the active ring supervisor sends Sign_On packets after transiting to the NORMAL_STATE. The active supervisor sends a Sign_On packet once every minute while in the NORMAL_STATE. When the active supervisor receives a Sign_On packet that it previously sent, it discontinues sending Sign_On packets. The device displays the ring participant list in the *Switching > L2-Redundancy > DLR Statistics* dialog.

The active ring supervisor sends the multicast Sign_On packets from the unblocked port. When a ring participant receives the Sign_On packet, it forwards the packet to the CPU of the device only. The CPU add the addresses of the participant and sends the Sign_On packet out of the port opposite from the receiving port.

The ring participants send the Sign_On packet around the ring. Each participant processes the Sign_On packet in similar manner. Eventually the Sign_On packet returns to the active ring supervisor. The active supervisor verifies that it sent the Sign_On packet. For this purpose the active supervisor checks the first entry in the ring participant list.

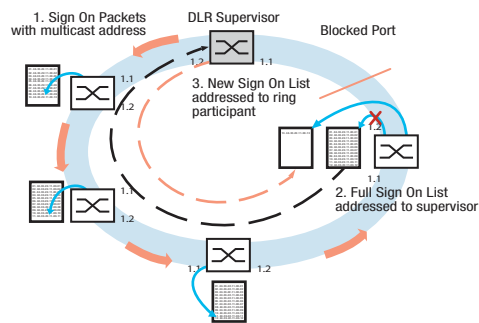

Figure 34: Sign On Process

If adding an address of a participant to the Sign_On packet exceeds the maximum packet size, then the participant does not add its address to the received packet. The participant saves the port on which it received the packet. Then the participant sends the Sign_On packet directly to the unicast MAC address of the active ring supervisor.

When the ring supervisor receives the Sign_On packet sent to its unicast MAC address, it assumes this is due to the Sign_On packet size reaching its maximum capacity. The supervisor restarts the process by sending a new Sign_On packet directly to the unicast MAC address of the participant from which it received the unicast Sign_On packet.

Upon receiving the new Sign_On packet from the active ring supervisor, the ring participant adds its address to the Sign_On packet. The participant then sends the multicast Sign_On packet on the ring port opposite from the port saved in memory.

12.3.5 Example Configuration

The Device Level Ring (DLR) protocol provides redundancy for Ethernet data in a ring topology. Using the DLR protocol you control and monitor Ethernet and IP devices.

■ EtherNet/IP Environments

When using the *DLR* function in conjunction with Ethernet environments verify that the parameters are specified as follows:

- ▶ *DLR*:
 - The *DLR* function is enabled.
 - The ports 1/1 and 1/2 are specified as the *DLR* ring ports.
 - The *Supervisor active* function is active.
- ▶ *EtherNet/IP*:
 - The *EtherNet/IP* function is enabled.
 - The *Write access* function is active.

- ▶ *Spanning Tree*:
 - The *Spanning Tree* function is disabled.
- ▶ VLANs:
 - The *VLAN unaware mode* function is active.
- ▶ *IGMP Snooping*:
 - The *IGMP Snooping* function is enabled, and active on every port.
 - The *IGMP Snooping Querier* function is enabled.
 - The *Snooping Enhancements* on *DLR* ring ports are specified as `Static (S)` and `Forward all (F)`.

When you order the device using the hardware code `D`, the values of parameters listed above are specified as the default settings.

For *DLR* operation within an *EtherNet/IP* environment for example, Rockwell or Allen-Bradley devices, you proceed as follows.

- Open the *Switching > Switching Global* dialog.
- In the *Configuration* frame, mark the *VLAN unaware mode* checkbox.
- To save the changes temporarily, click the button.
- Open the *Switching > L2-Redundancy > DLR > DLR Configuration* dialog.
- To add a table entry, click the  button.
- In the *Name* column, specify the value `DLR_Ring_1`.
- In the *VLAN ID* column, specify the value `0`.
- To activate the configuration, mark the checkbox in the *Active* column.
- To enable the function, select the *On* radio button in the *Operation* frame.
- To save the changes temporarily, click the button.

| | |
|---|---|
| <pre>enable vlan database vlan-unaware-mode exit configure dlr ring add 1 dlr ring modify 1 name DLR_Ring_1 dlr ring modify 1 port-1 1/1 dlr ring modify 1 port-2 1/2 dlr ring modify 1 precedence 250 dlr ring modify 1 supervisor enable dlr ring modify 1 vlan 0 dlr ring modify 1 operation enable dlr operation</pre> | <p>Change to the Privileged EXEC mode.</p> <p>Change to the VLAN configuration mode.</p> <p>Activate the <i>VLAN unaware mode</i> function.</p> <p>Change to the Privileged EXEC mode.</p> <p>Change to the Configuration mode.</p> <p>Create the <i>DLR</i> ring 1.</p> <p>Specify the value <code>DLR_Ring_1</code> as the name of the <i>DLR</i> ring.</p> <p>Specify port <code>1/1</code> as the <i>DLR</i> ring port 1.</p> <p>Specify port <code>1/2</code> as the <i>DLR</i> ring port 2.</p> <p>Specify the value <code>250</code> as the supervisor precedence.</p> <p>Enable the ring supervisor function.</p> <p>Specify the value <code>0</code> as the VLAN identifier. The device uses the VLAN to forward the <i>DLR</i> protocol messages.</p> <p>Enable the <i>DLR</i> function for ring 1.</p> <p>Enable the global <i>DLR</i> function.</p> |
|---|---|

12.4 Parallel Redundancy Protocol (PRP)

Unlike ring redundancy protocols, PRP uses 2 separate LANs for uninterrupted availability. On the path from the sender to the receiver, PRP sends 2 data packets in parallel via the 2 mutually independent LANs. The receiver processes the first data packet received and discards the second data packet of the pair. The international standard IEC 62439-3 defines the Parallel Redundancy Protocol (PRP).

Note: If PRP is active, it uses the interfaces 1/1 and 1/2. As seen in the *Switching > VLAN*, *Switching > Rate Limiter* and *Switching > Filter for MAC Addresses* dialogs, the PRP function replaces the interfaces 1/1 and 1/2 with the interface prp/1. Configure the VLAN membership, the rate limiting, and the MAC filtering for the interface prp/1.

12.4.1 Implementation

When the upper protocol layers send a data packet, the PRP interface creates a “twin packet” from the original packet. The PRP interface then transmits 1 data packet of the pair to each participating LAN simultaneously. The packets traverse different LANs and therefore have different run times.

The receiving PRP interface forwards the first packet of a pair towards the upper protocol layers and discards the second packet. When viewed from the application, a PRP interface functions like a standard Ethernet interface.

The PRP interface or a Redundancy Box (RedBox) injects a Redundancy Control Trailer (RCT) into each packet. The RCT is a 48-bit identification field and is responsible for the identification of duplicates. This field contains, LAN identification (LAN A or B), information about the length of the payload, and a 16-bit sequence number. The twin packets therefore differ exclusively in the LAN identification and as a result in the FCS checksum. The PRP interface increments the sequence number for each packet sent. Using the unique attributes included in each packet, such as Physical MAC source address and sequence number, the receiving RedBox or Double Attached Node (DAN) interface identifies and discards duplicates.

Depending on the packet size, with PRP it attains a reduced throughput of the available bandwidth, due to the addition of the RCT trailer.

12.4.2 LRE functionality

Each Double Attached Node implementing PRP (DANP) has 2 LAN ports that operate in parallel. The Link Redundancy Entity (LRE) connects the upper protocol layers with every individual port.

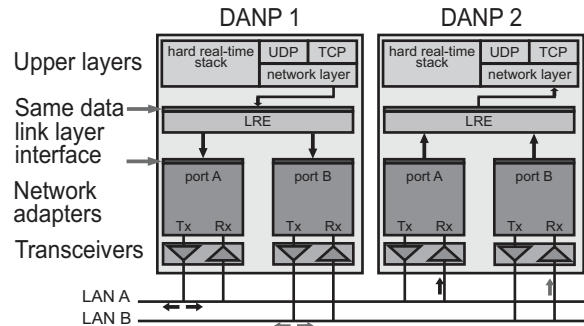

Figure 35: PRP LRE process

The LRE has the following tasks:

- ▶ Handling of duplicates
- ▶ Management of redundancy

When transmitting packets from the upper protocol layers, the LRE sends them from both ports at nearly the same time. The 2 data packets pass through the LANs with different delays. When the device receives the first data packet, the LRE forwards it to the upper protocol layers and discards the second data packet received.

For the upper protocol layers, the LRE behaves like a normal port.

To identify the twin packets, the LRE attaches an RCT with a sequential number to the packets. The LRE also periodically sends multicast PRP supervision packets and evaluates the multicast PRP supervision packets of the other RedBoxes and DANPs.

The device allows you to view the received supervision packet entries. The entries in the *Switching > L2-Redundancy > PRP > PRP DAN/VDAN Table* are helpful for detecting redundancy and connection problems. For example, in an index when the *Last seen B* timestamp resets and the *Last seen A* timestamp remains the same. The *Last seen A* and *Last seen B* timestamps steadily resetting indicate a normal condition.

Note: According to IEC 62439, the Entry Forget Time is 400 ms. The Entry Forget Time is the time after which the device removes an entry from the duplicate table. If the device receives the 2nd packet of a pair after 400 ms or later, then the device processes the 2nd packet instead of discarding it. To prevent this, Hirschmann recommends that you use a maximum bandwidth of 90%.

Note: If the inter-frame gap is shorter than the latency between the 2 LANs, a frame-ordering mismatch can occur. Frame-ordering mismatch is a phenomenon of the PRP protocol. The only solution for avoiding a frame-ordering mismatch is to verify that the inter-frame gap is greater than the latency between the LANs.

12.4.3 PRP Network Structure

PRP uses 2 independent LANs. The topology of each of these LANs is arbitrary, and ring, star, bus and meshed topologies are possible.

The main advantage of PRP is zero recovery time with an active (transit) LAN. When the end device receives no packets from one of the LANs, the second (transit) LAN maintains the connection. As long as 1 (transit) LAN is available, repairs and maintenance on the other (transit) LAN have no impact on the data packet transmission.

The elementary devices of a PRP network are the RedBox (Redundancy Box) and the DANP (Double Attached Node implementing PRP). Both devices have 1 connection each to the (transit) LANs.

The devices in the (transit) LAN are conventional switches. The devices transmit PRP data packets transparently, without evaluating the RCT information.

Note: The RCT trailer increases packet size. Configure the MTU size equal to or greater than 1524 for LAN A and LAN B devices.

Terminal devices that connect directly to a device in the (transit) LAN are SANs (Single Attached Nodes). SANs connected to a LAN have no redundancy. To use the PRP redundant network, connect the SAN to the PRP network via a RedBox.

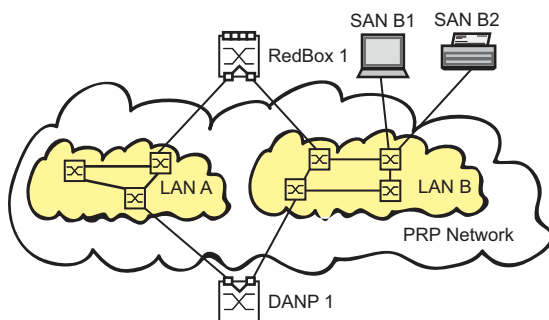

Figure 36: Parallel Redundancy Protocol Network

12.4.4 Connecting RedBoxes and DANPs to a PRP network

DANPs have 2 interfaces for the connection to the PRP network. A RedBox is a DANP that contains additional switch ports. Use the switch ports to integrate one or more SANs into the PRP network redundantly.

The Link Redundancy Entity (LRE) in the RedBox creates a twin packet when sending a data packet to the PRP network. The LRE forwards 1 data packet of the twin pair when it receives it and discards the 2nd data packet of the twin pair.

Note: The Redbox supports up to 128 hosts. When attempt to support more than 128 with the Redbox, then device drops packets.

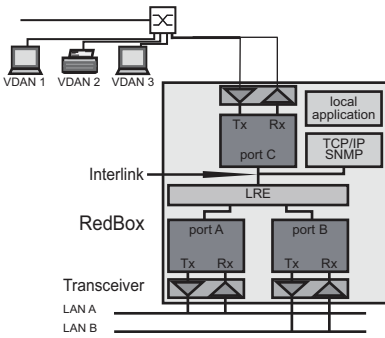

Figure 37: RedBox Transition from double to single LAN

12.4.5 Example Configuration

The following example uses a simple PRP network with 4 devices. Verify that the LAN A and LAN B ports contain 100 Mbit/s optical SFP interfaces. Connect Port A to LAN A and the Port B to LAN B.

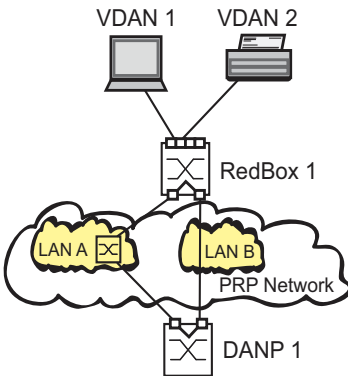

Figure 38: Example PRP Network

Note: *PRP* is available for devices with an FPGA (hardware for extended functions). The product code indicates whether your device supports *PRP*. In order to use the functions, load the device software supporting *PRP*.



The PRP function reserves ports 1/1 and 1/2. This removes the possibility of using other redundancy protocols such as Spanning Tree or MRP in parallel on ports 1/1 and 1/2.

- If you use Spanning Tree in parallel to PRP, deactivate Spanning Tree on ports 1/1 and 1/2. Also deactivate the functions *Root guard*, *TCN guard* and *Loop guard* on ports 1/1 and 1/2.
- If you use MRP in parallel to PRP, specify the other free device ports as MRP-Ring ports.

Perform the following steps on both the RedBox 1 and DANP 1 devices.

- Open the *Switching > L2-Redundancy > PRP > Configuration* dialog.
- Perform the following steps in the *Supervision packet receiver* frame:
- To analyze received PRP supervision packets, activate the *Evaluate supervision packets* checkbox.

Perform the following steps in the *Supervision packet sender* frame:

- To transmit PRP supervision packets from this device, activate *Active*.
- The device sends either its own PRP supervision packets exclusively, or sends both its own supervision packets and packets of connected devices. To transmit packets for VDANs listed in the *Switching > L2-Redundancy > PRP > PRP DAN/VDAN Table*, activate *Send VDAN packets*. When deactivated the device sends its own supervision packets exclusively. After installing new PRP devices, deactivate this function to maintain a clear overview of the PRP supervision packets on remote devices.
- To enable the ports, in the *Port A* and *Port B* frames, select the value *On*.
- To enable the function, select in the *Operation* frame the *On* radio button.
- To save the changes temporarily, click the button.
- To load the configuration saved in the volatile memory, click the  button.
- Open the *Switching > L2-Redundancy > PRP > PRP Proxy Node Table* dialog to view the terminating VDAN devices for which this device provides PRP conversion.
- To remove this list, click *Reset*.
- To load the list of currently connected devices, click the  button.
- Open the *Switching > L2-Redundancy > PRP > PRP Statistics* dialog to view the quality of the traffic that traverses the device. The device detects errors and displays them according to MIB Managed Objects and the respective link.
- To remove the entry in the statistics table, click *Reset*.
- To load the current statistics, click the  button.

The device allows you to view the received supervision packet entries. The entries in the *Switching > L2-Redundancy > PRP > PRP DAN/VDAN Table* are helpful for detecting redundancy and connection problems. For example, in an index when the *Last seen B* timestamp resets and the *Last seen A* timestamp remains the same. The *Last seen A* and *Last seen A* timestamps steadily resetting indicate a normal condition.

Note: If you deactivate the PRP function, then deactivate either Port “A” or “B” to help prevent network loops.

| | |
|--|--|
| enable | Change to the Privileged EXEC mode. |
| configure | Change to the Configuration mode. |
| no mrp operation | Disable the option. |
| no spanning-tree operation | Disable the option. |
| interface 1/1 | Change to the interface configuration mode of interface 1/1. |
| no shutdown | Enable the interface. |
| exit | Change to the Configuration mode. |
| interface 1/2 | Change to the interface configuration mode of interface 1/2. |
| no shutdown | Enable the interface. |
| exit | Change to the Configuration mode. |
| prp instance 1 supervision evaluate | Enable evaluation of received supervision packets. |
| prp instance 1 supervision send | Enable supervision packet transmission. |
| prp instance 1 supervision redbox-exclusively | Sends supervision packets for this RedBox exclusively. Use the no form of the command to send supervision packets for each connected VDAN and this RedBox. The prerequisite is that you enable the supervision packet send function. |
| prp operation | Enable the <i>PRP</i> function. |
| show prp counters | Display the PRP counters. |
| show prp node-table | Display the node table. |
| show prp proxy-node-table | Display the proxy node table. |

12.5 High-availability Seamless Redundancy (HSR)

As with PRP, an HSR ring also offers zero recovery time. HSR is suited for applications that demand high availability and short reaction times. For example, protection applications for electrical station automation and controllers for synchronized drives which require constant connection.

Note: If HSR is active, it uses the interfaces 1/1 and 1/2. As seen in the *Switching > Rate Limiter* and *Switching > Filter for MAC Addresses* dialogs, the HSR function replaces the interfaces 1/1 and 1/2 with the interface hsr/1. Set up the VLAN membership and the rate limiting for the interface hsr/1.

12.5.1 Implementation

HSR Redundancy Boxes (RedBox) use 2 Ethernet ports operating in parallel to connect to a ring. An HSR RedBox operating in this configuration is a Doubly Attached Node implementing the HSR protocol (DANH). A standard ethernet device connected to the HSR ring through an HSR RedBox is a Virtual DANH (VDANH).

As with PRP, the transmitting HSR Node or HSR RedBox sends twin packets, 1 in each direction, on the ring. For identification, the HSR node injects the twin packets with an HSR tag. The HSR tag consists of a port identifier, the length of the payload and a sequence number. In a normal operating ring, the destination HSR node or RedBox receives both packets within a certain time skew. An HSR node forwards the first packet arrived and discards the second packet when it arrives. A RedBox on the other hand forwards the first packet to the VDANHs and discards the second packet when it arrives.

The HSR Nodes and HSR RedBoxes insert an HSR tag after the source MAC Address in the packet. The advantage to the HSR tag placement is that the device is able to forward the packet immediately after receiving the HSR header and performing duplicate recognition. Affectively decreasing the delay time within the device. In contrast to PRP where the RCT contains a PRP suffix near the end of the packet. Meaning that a PRP device receives the entire packet before forwarding the packet out of the correct port.

HSR Nodes and HSR RedBoxes also use the LRE function as described in the PRP chapter. As with PRP, the LRE in the HSR RedBoxes are responsible for tagging and duplicate recognition.

The number of HSR nodes in the ring should not exceed 50.

It is useful to limit the traffic injected into the HSR ring. If there are any third party devices with a higher latency in the ring, then the consequence is that you reduce the number of ring participants. Verify that the sum of bandwidths applied to the HSR nodes is less than 84 %.

Note: *HSR* is available for devices with an FPGA (hardware for extended functions). The product code indicates whether your device supports *HSR*. In order to use the functions, load the device software supporting *HSR*.

12.5.2 HSR Network Structure

An HSR Network consists of a ring, where each HSR device performs a specific role in the network. An HSR device for example, connects standard ethernet devices to an HSR ring, or PRP LANs to an HSR ring.

■ Connecting SANs to an HSR Network

Standard ethernet devices, such as laptops or printers, have 1 network interface. Therefore, standard ethernet devices transmit traffic across an HSR ring through an HSR RedBox which acts as a proxy for the ethernet devices attached to it. The HSR RedBox interfaces transmit 1 twin packet in each direction around the network.

The host HSR RedBox forwards the first unicast packet exclusively to the destination VDANH and discards the second unicast packet when it arrives.

The HSR Nodes and RedBoxes forward multicast and broadcast traffic around the ring and also to the connected VDANH devices. To help prevent the traffic from endlessly looping around the ring, the node originally transmitting the traffic on the network discards the transmitted frames when received.

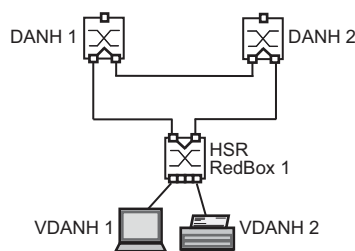

Figure 39: Connecting a VDANH to an HSR network

■ SAN Device Connection Example Configuration

A simple HSR network consists of 3 HSR devices as seen in the previous figure. The following example configures a host HSR RedBox for standard ethernet devices.

Deactivate STP on the PRP ports or globally. Also, deactivate MRP on the PRP ports or configure MRP on ports other than the PRP ports.

- Open the *Switching > L2-Redundancy > MRP* dialog.
- To disable the function, select the *Off* radio button in the *Operation* frame.
- Verify that the ports in *Ring port 1* and *Ring port 2* frames are different from the ports used by the *HSR* function.
- Open the *Switching > L2-Redundancy > Spanning Tree > Global* dialog.
- To disable the function, select the *Off* radio button in the *Operation* frame.
- Open the *Switching > L2-Redundancy > Spanning Tree > Port* dialog.
- In the *CIST* tab, deactivate the ports used for HSR in the *STP active* column.
- In the *Guards* tab, deactivate the ports used for HSR in the *Root guard*, *TCN guard* and *Loop guard* columns.

Note: If you deactivate the HSR function, then deactivate either Port “A” or “B” to help prevent network loops.



The device sends either its own HSR supervision packets exclusively, or sends both its own supervision packets and packets of connected devices. After installing new HSR devices, deactivate this function to maintain a clear overview of the HSR supervision packets on remote devices.

- Open the *Switching > L2-Redundancy > HSR > HSR > HSR > Configuration* dialog.
- To analyze received HSR supervision packets, activate the *Evaluate supervision packets* checkbox in the *Supervision packet receiver* frame.
- To transmit HSR supervision packets from this device, activate *Active* in the *Supervision packet sender* frame.
- To transmit packets for VDANs listed in the *Switching > L2-Redundancy > HSR > HSR DAN/VDAN Table* dialog, activate *Send VDAN packets*.

Use the following steps to configure HSR RedBox 1:

- To configure the device to forward unicast traffic around the ring and to the destination device, set the *HSR mode* to *modeu*.
- To configure the device as an HSR host, set *Switching node type* to *hsrredboxsan*.

Note: Setting *Switching node type* to *hsrredboxsan* disables the *Redbox identity* function.

- To enable the ports, select the *On* radio button in the Port *Port A* and Port *Port B* frames.
- To enable the function, select the *On* radio button in the *Operation* frame.
- To save the changes temporarily, click the button.
- To load the configuration saved in the volatile memory, click the  button.
- Open the *Switching > L2-Redundancy > HSR > HSR DAN/VDAN Table* dialog to view the traffic received from the LAN. This information helps you in detecting how the LANs are functioning.
- To remove this list, click *Reset*.
- To update the table entries, click the  button.
- Open the *Switching > L2-Redundancy > HSR > HSR Proxy Node Table* dialog to view the terminating VDAN devices for which this device provides HSR conversion.
- To remove the entries in the proxy table, click *Reset*.
- To update the table entries, click the  button.

The device detects errors and displays them according to MIB Managed Objects and the respective link.

- Open the *Switching > L2-Redundancy > HSR > HSR Statistics* dialog to view the quality of the traffic that traverses the device.
- To remove the entry in the statistics table, click *Reset*.
- To load the current statistics, click the  button.

Another possibility is to configure the host HSR RedBox 1 using the following CLI commands:

| | |
|----------------------------|--|
| enable | Change to the Privileged EXEC mode. |
| configure | Change to the Configuration mode. |
| no mrp operation | Disable the option. |
| no spanning-tree operation | Disable the option. |
| interface 1/1 | Change to the interface configuration mode of interface 1/1. |
| no shutdown | Enable the interface. |
| exit | Change to the Configuration mode. |
| interface 1/2 | Change to the interface configuration mode of interface 1/2. |
| no shutdown | Enable the interface. |
| exit | Change to the Configuration mode. |

```
hsr instance 1 mode modeu
```

```
hsr instance 1 port-a
```

```
hsr instance 1 port-b
```

```
hsr instance 1 switching-node-type  
hsrredboxsan
```

```
hsr instance 1 supervision evaluate
```

```
hsr instance 1 supervision send
```

```
hsr instance 1 supervision
```

```
redbox-exclusively
```

```
hsr operation
```

The HSR host forwards unicast traffic to the connected VDANs and around the ring.

Activate the HSR Port A.

Activate the HSR Port B.

Enable the device to process traffic destined for LAN B of the PRP network.

Enable evaluation of received supervision packets.

Enable supervision packet transmission.

Sends supervision packets for this RedBox exclusively. Use the `no` form of the command to send supervision packets for each connected VDAN and this RedBox. The prerequisite is that you enable the supervision packet send function.

Enable the *HSR* function.

View traffic statistics on a device using the show commands.

```
show hsr counters
```

```
show hsr node-table
```

```
show hsr proxy-node-table
```

Display the HSR counters.

Display the node table.

Display the proxy node table.

■ HSR and PRP network connections

When connecting PRP networks to an HSR network, the HSR device uses 2 interfaces to connect to the HSR ring. The HSR device uses a third interface to connect to either LAN A or LAN B of the PRP network as seen in the following figure. The HSR device transmitting the traffic across the HSR ring identifies traffic destined for PRP networks with the appropriate tag. The HSR devices then forward the PRP traffic through LAN A or LAN B. The PRP device receives the traffic and processes it as described in the PRP chapter.

The HSR devices identify and tag traffic for up to 7 PRP networks connected to 1 HSR ring.

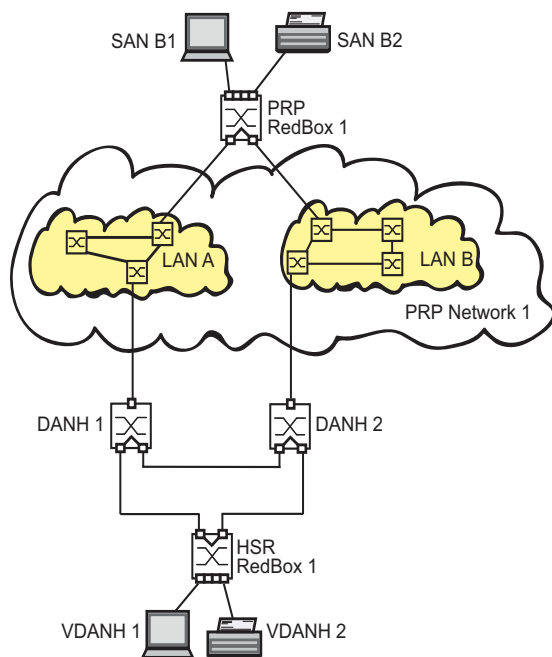

Figure 40: Connecting a PRP network to an HSR network

HSR Redboxes use 2 interfaces for the HSR ring. When configured to manage PRP traffic, a third interface connects to a LAN of the PRP network. The other interfaces provide HSR network access for VDANs. The HSR RedBox lists the connected VDANs in the *Switching > L2-Redundancy > HSR > HSR Proxy Node Table*.

■ PRP Network Connection Example Configuration

The following example configures a simple HSR network with 3 HSR devices as shown in the previous figure. Use the HSR RedBox configured in the previous example to connect the standard ethernet devices to the HSR ring. HSR RedBox 1 sends 1 twin packet toward DANH 1 and 1 twin packet toward DANH 2. When the first packet of a pair arrives, DANH 1 sends the packet to PRP network 1 LAN A and DANH 2 sends the packet to PRP network 1 LAN B.

Deactivate STP on the PRP ports or globally. Also, deactivate MRP on the PRP ports or configure MRP on ports other than the PRP ports.

Use the HSR RedBox configured in the previous example for HSR RedBox 1. Perform the following steps on the DANH 1 and 2.

- Open the *Switching > L2-Redundancy > MRP* dialog.
- To disable the function, select the *Off* radio button in the *Operation* frame.
- Verify that the ports in *Ring port 1* and *Ring port 2* frames are different from the ports used by the *HSR* function.
- Open the *Switching > L2-Redundancy > Spanning Tree > Global* dialog.
- To disable the function, select the *Off* radio button in the *Operation* frame.
- Open the *Switching > L2-Redundancy > Spanning Tree > Port* dialog.
- In the *CIST* tab, deactivate the ports used for HSR in the *STP active* column.
- In the *Guards* tab, deactivate the ports used for HSR in the *Root guard*, *TCN guard* and *Loop guard* columns.

Note: If you deactivate the HSR function, then deactivate either Port “A” or “B” to help prevent network loops.

The device sends either its own HSR supervision packets exclusively, or sends both its own supervision packets and packets of connected devices. After installing new HSR devices, deactivate this function to maintain a clear overview of the HSR supervision packets on remote devices.

- Open the *Switching > L2-Redundancy > HSR > HSR > HSR > Configuration* dialog.
- To analyze received HSR supervision packets, activate the *Evaluate supervision packets* checkbox in the *Supervision packet receiver* frame.
- To transmit HSR supervision packets from this device, activate *Active* in the *Supervision packet sender* frame.
- To transmit packets for VDANs listed in the *Switching > L2-Redundancy > HSR > HSR DAN/VDAN Table* dialog, activate *Send VDAN packets*.

Use the following steps to configure DANH 1:

- Open the *Switching > L2-Redundancy > HSR > HSR > HSR > Configuration* dialog.
- To configure the device to forward unicast traffic around the ring and to the destination device, set the *HSR mode* to *modeu*.
- To configure the device to forward traffic to PRP LAN A, set the *Switching node type* to *hsrredboxprpa*.
- To configure the device to forward traffic to PRP network 1 LAN A, set *Redbox identity* to *id1a*.
- To enable the ports, select the *On* radio button in the Port *Port A* and Port *Port B* frames.
- To enable the function, select the *On* radio button in the *Operation* frame.
- To save the changes temporarily, click the button.
- To load the configuration saved in the volatile memory, click the  button.

Use the following configuration for DANH 2:

- Open the *Switching > L2-Redundancy > HSR > HSR > HSR > Configuration* dialog.

- To configure the device to forward unicast traffic around the ring and to the destination device, set the *HSR mode* to `modeu`.
- To configure the device to forward traffic to PRP LAN A, set the *Switching node type* to `hsrredboxprpb`.
- To configure the device to forward traffic to PRP network 1 LAN B, set *Redbox identity* to `idlb`.
- To enable the ports, select the *On* radio button in the Port *Port A* and Port *Port B* frames.
- To enable the function, select the *On* radio button in the *Operation* frame.
- To save the changes temporarily, click the button.
- To load the configuration saved in the volatile memory, click the  button.

Another possibility is to use the following CLI commands to configure the HSR devices 1 and 2.

| | |
|---|--|
| <code>enable</code> | Change to the Privileged EXEC mode. |
| <code>configure</code> | Change to the Configuration mode. |
| <code>no mrp operation</code> | Disable the option. |
| <code>no spanning-tree operation</code> | Disable the option. |
| <code>interface 1/1</code> | Change to the interface configuration mode of interface 1/1. |
| <code>no shutdown</code> | Enable the interface. |
| <code>exit</code> | Change to the Configuration mode. |
| <code>interface 1/2</code> | Change to the interface configuration mode of interface 1/2. |
| <code>no shutdown</code> | Enable the interface. |
| <code>exit</code> | Change to the Configuration mode. |

Use the following CLI commands to configure DANH 1 to process traffic for PRP network 1 LAN A.

| | |
|---|---|
| <code>hsr instance 1 mode modeu</code> | The HSR host forwards unicast traffic to the connected VDANs and around the ring. |
| <code>hsr instance 1 port-a</code> | Activate the HSR Port A. |
| <code>hsr instance 1 port-b</code> | Activate the HSR Port B. |
| <code>hsr instance 1 switching-node-type hsrredboxprpa</code> | Enable the device to process traffic destined for LAN A of the PRP network. |
| <code>hsr instance 1 redbox-id idla</code> | Enable the device to process traffic destined for LAN A of the PRP network 1. |
| <code>hsr instance 1 supervision evaluate</code> | Enable evaluation of received supervision packets. |
| <code>hsr instance 1 supervision send</code> | Enable supervision packet transmission. |
| <code>hsr instance 1 supervision redbox-exclusively</code> | Sends supervision packets for this RedBox exclusively. Use the <code>no</code> form of the command to send supervision packets for each connected VDAN and this RedBox. The prerequisite is that you enable the supervision packet send function. |
| <code>hsr operation</code> | Enable the <i>HSR</i> function. |

Use the following CLI commands to configure DANH 2 to process traffic for PRP network 1 LAN B.

| | |
|---|---|
| <code>hsr instance 1 mode modeu</code> | The HSR host forwards unicast traffic to the connected VDANs and around the ring. |
| <code>hsr instance 1 port-a</code> | Activate the HSR Port A. |
| <code>hsr instance 1 port-b</code> | Activate the HSR Port B. |
| <code>hsr instance 1 switching-node-type hsrredboxprpb</code> | Enable the device to process traffic destined for LAN B of the PRP network. |
| <code>hsr instance 1 redbox-id idlb</code> | Enable the device to process traffic destined for LAN B of the PRP network 1. |
| <code>hsr instance 1 supervision evaluate</code> | Enable evaluation of received supervision packets. |
| <code>hsr instance 1 supervision send</code> | Enable supervision packet transmission. |
| <code>hsr instance 1 supervision redbox-exclusively</code> | Sends supervision packets for this RedBox exclusively. Use the <code>no</code> form of the command to send supervision packets for each connected VDAN and this RedBox. The prerequisite is that you enable the supervision packet send function. |
| <code>hsr operation</code> | Enable the <i>HSR</i> function. |

View traffic statistics on a device using the show commands.

`show hsr counters`

Display the HSR counters.

`show hsr node-table`

Display the node table.

`show hsr proxy-node-table`

Display the proxy node table.

12.6 Spanning Tree

Note: The Spanning Tree Protocol is a protocol for MAC bridges. For this reason, the following description uses the term bridge for the device.

Local networks are getting bigger and bigger. This applies to both the geographical expansion and the number of network participants. Therefore, it is advantageous to use multiple bridges, for example:

- ▶ to reduce the network load in sub-areas,
- ▶ to set up redundant connections and
- ▶ to overcome distance limitations.

However, using multiple bridges with multiple redundant connections between the subnetworks can lead to loops and thus loss of communication across of the network. In order to help avoid this, you can use Spanning Tree. Spanning Tree enables loop-free switching through the systematic deactivation of redundant connections. Redundancy enables the systematic reactivation of individual connections as needed.

RSTP is a further development of the Spanning Tree Protocol (STP) and is compatible with it. If a connection or a bridge becomes inoperable, the STP required a maximum of 30 seconds to reconfigure. This is no longer acceptable in time-sensitive applications. RSTP achieves average reconfiguration times of less than a second. When you use RSTP in a ring topology with 10 to 20 devices, you can even achieve reconfiguration times in the order of milliseconds.

Note: RSTP reduces a layer 2 network topology with redundant paths into a tree structure (Spanning Tree) that does not contain any more redundant paths. One of the devices takes over the role of the root bridge here. The maximum number of devices permitted in an active branch (from the root bridge to the tip of the branch) is specified by the variable `Max Age` for the current root bridge. The preset value for `Max Age` is 20, which can be increased up to 40.

If the device working as the root is inoperable and another device takes over its function, the `Max Age` setting of the new root bridge determines the maximum number of devices allowed in a branch.

Note: The RSTP standard dictates that all the devices within a network work with the (Rapid) Spanning Tree Algorithm. If STP and RSTP are used at the same time, the advantages of faster reconfiguration with RSTP are lost in the network segments that are operated in combination.

A device that only supports RSTP works together with MSTP devices by not assigning an MST region to itself, but rather the CST (Common Spanning Tree).

12.6.1 Basics

Because RSTP is a further development of the STP, all the following descriptions of the STP also apply to the RSTP.

■ The tasks of the STP

The Spanning Tree Algorithm reduces network topologies built with bridges and containing ring structures due to redundant links to a tree structure. In doing so, STP opens ring structures according to preset rules by deactivating redundant paths. If a path is interrupted because a network component becomes inoperable, STP reactivates the previously deactivated path again. This allows redundant links to increase the availability of communication.

STP determines a bridge that represents the STP tree structure's base. This bridge is called root bridge.

Features of the STP algorithm:

- ▶ automatic reconfiguration of the tree structure in the case of a bridge becoming inoperable or the interruption of a data path
- ▶ the tree structure is stabilized up to the maximum network size,
- ▶ stabilization of the topology within a short time period
- ▶ topology can be specified and reproduced by the administrator
- ▶ transparency for the end devices
- ▶ low network load relative to the available transmission capacity due to the tree structure created

■ Bridge parameters

In the context of Spanning Tree, each bridge and its connections are uniquely described by the following parameters:

- ▶ Bridge Identifier
- ▶ Root Path Cost for the bridge ports,
- ▶ Port Identifier

■ Bridge Identifier

The Bridge Identifier consists of 8 bytes. The 2 highest-value bytes are the priority. The default setting for the priority number is 32,768, but the Management Administrator can change this when configuring the network. The 6 lowest-value bytes of the bridge identifier are the bridge's MAC address. The MAC address allows each bridge to have unique bridge identifiers.

The bridge with the smallest number for the bridge identifier has the highest priority.

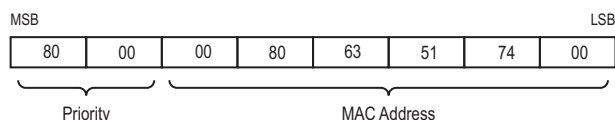

Figure 41: Bridge Identifier, Example (values in hexadecimal notation)

■ Root Path Cost

Each path that connects 2 bridges is assigned a cost for the transmission (path cost). The device determines this value based on the transmission speed (see table 22). It assigns a higher path cost to paths with lower transmission speeds.

Alternatively, the Administrator can set the path cost. Like the device, the Administrator assigns a higher path cost to paths with lower transmission speeds. However, since the Administrator can choose this value freely, he has a tool with which he can give a certain path an advantage among redundant paths.

The root path cost is the sum of all individual costs of those paths that a data packet has to traverse from a connected bridge's port to the root bridge.

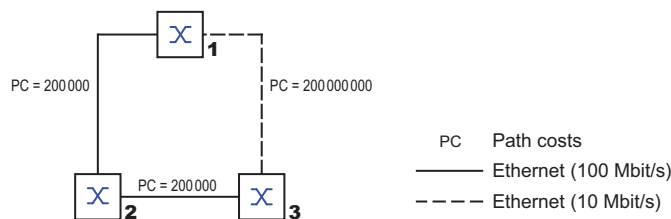

Figure 42: Path costs

| Data rate | Recommended value | Recommended range | Possible range |
|-------------|--------------------------|--------------------|----------------|
| ≤100 Kbit/s | 200 000 000 ^a | 20000000-200000000 | 1-200 000 000 |
| 1 Mbit/s | 20000000 ^a | 2000000-200000000 | 1-200 000 000 |
| 10 Mbit/s | 2000000 ^a | 200000-20000000 | 1-200 000 000 |
| 100 Mbit/s | 200000 ^a | 20000-2000000 | 1-200 000 000 |
| 1 Gbit/s | 20000 | 2000-200000 | 1-200 000 000 |
| 10 Gbit/s | 2000 | 200-20000 | 1-200 000 000 |
| 100 Gbit/s | 200 | 20-2000 | 1-200 000 000 |
| 1 TBit/s | 20 | 2-200 | 1-200 000 000 |
| 10 TBit/s | 2 | 1-20 | 1-200 000 000 |

Table 22: Recommended path costs for RSTP based on the data rate.

a. Bridges that conform with IEEE 802.1D 1998 and only support 16-bit values for the path costs should use the value 65,535 (FFFFH) for path costs when they are used in conjunction with bridges that support 32-bit values for the path costs.

■ Port Identifier

The port identifier consists of 2 bytes. One part, the lower-value byte, contains the physical port number. This provides a unique identifier for the port of this bridge. The second, higher-value part is the port priority, which is specified by the Administrator (default value: 128). It also applies here that the port with the smallest number for the port identifier has the highest priority.

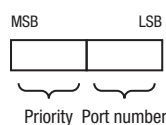

Figure 43: Port Identifier

■ Max Age and Diameter

The “Max Age” and “Diameter” values largely determine the maximum expansion of a Spanning Tree network.

■ Diameter

The number of connections between the devices in the network that are furthest removed from each other is known as the network diameter.

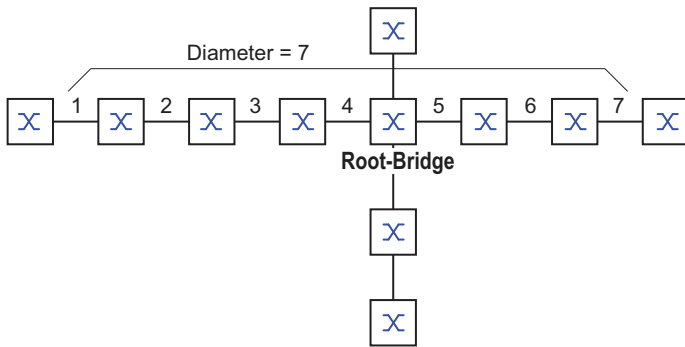

Figure 44: Definition of diameter

The network diameter that can be achieved in the network is $\text{MaxAge}-1$.
In the state on delivery, $\text{MaxAge} = 20$ and the maximum diameter that can be achieved = 19. If you set the maximum value of 40 for MaxAge , the maximum diameter that can be achieved = 39.

■ MaxAge

Every STP-BPDU contains a “MessageAge” counter. When a bridge is passed through, the counter increases by 1.

Before forwarding a STP-BPDU, the bridge compares the “MessageAge” counter with the “MaxAge” value specified in the device:

- If $\text{MessageAge} < \text{MaxAge}$, the bridge forwards the STP-BPDU to the next bridge.
- If $\text{MessageAge} = \text{MaxAge}$, the bridge discards the STP-BPDU.

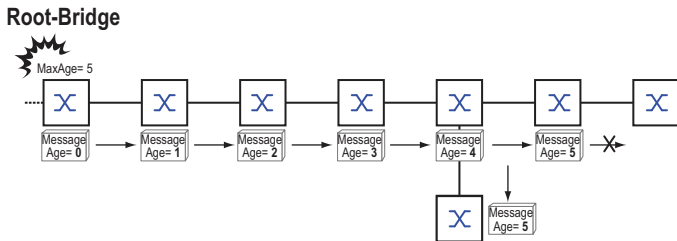

Figure 45: Transmission of an STP-BPDU depending on MaxAge

12.6.2 Rules for Creating the Tree Structure

■ Bridge information

To determine the tree structure, the bridges need more detailed information about the other bridges located in the network.

To obtain this information, each bridge sends a BPDU (Bridge Protocol Data Unit) to the other bridges.

The contents of a BPDU include:

- ▶ Bridge identifier
- ▶ Root path costs
- ▶ Port identifier

(see IEEE 802.1D)

■ Setting up the tree structure

- ▶ The bridge with the smallest number for the bridge identifier is called the root bridge. It is (or will become) the root of the tree structure.
- ▶ The structure of the tree depends on the root path costs. Spanning Tree selects the structure so that the path costs between each individual bridge and the root bridge become as small as possible.
- ▶ If there are multiple paths with the same root path costs, the bridge further away from the root decides which port it blocks. For this purpose, it uses the bridge identifiers of the bridge closer to the root. The bridge blocks the port that leads to the bridge with the numerically higher ID (a numerically higher ID is the logically worse one). If 2 bridges have the same priority, the bridge with the numerically larger MAC address has the numerically higher ID, which is logically the worse one.
- ▶ If multiple paths with the same root path costs lead from one bridge to the same bridge, the bridge further away from the root uses the port identifier of the other bridge as the last criterion (see [figure 43](#)). In the process, the bridge blocks the port that leads to the port with the numerically higher ID (a numerically higher ID is the logically worse one). If 2 ports have the same priority, the port with the higher port number has the numerically higher ID, which is logically the worse one.

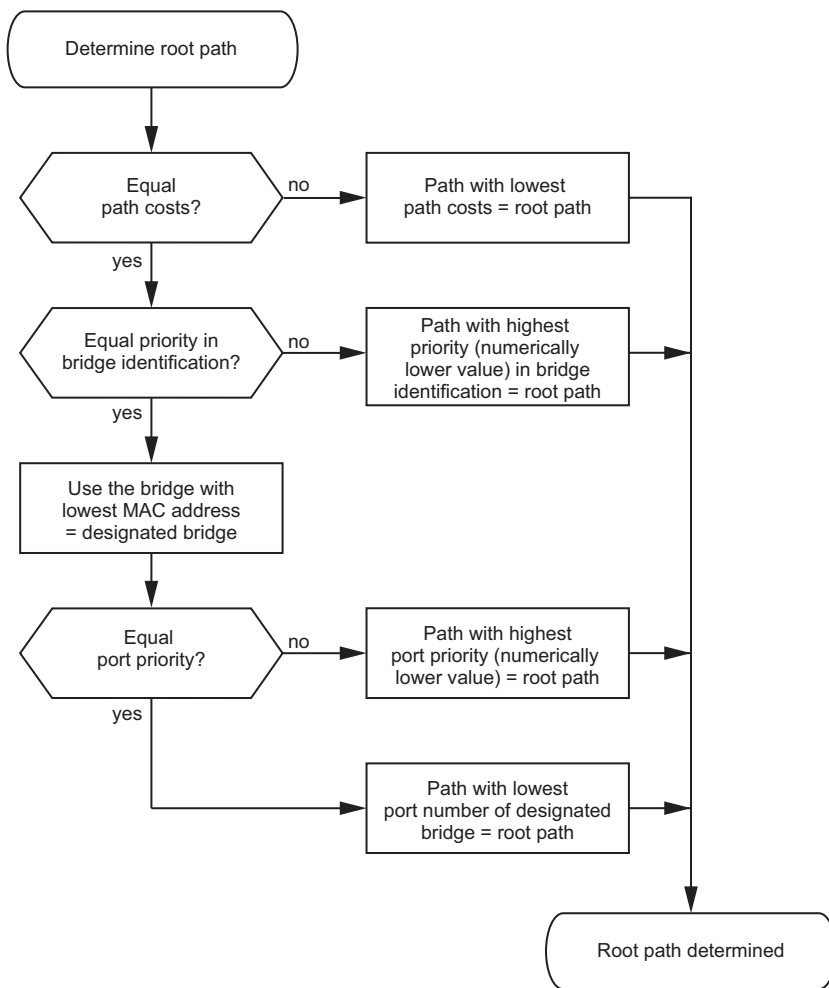

Figure 46: Flow diagram for specifying the root path

12.6.3 Examples

■ Example of determining the root path

You can use the network plan (see figure 47) to follow the flow chart (see figure 46) for determining the root path. The administrator has specified a priority in the bridge identification for each bridge. The bridge with the smallest numerical value for the bridge identification takes on the role of the root bridge, in this case, bridge 1. In the example all the sub-paths have the same path costs. The protocol blocks the path between bridge 2 and bridge 3 as a connection from bridge 3 via bridge 2 to the root bridge would result in higher path costs.

The path from bridge 6 to the root bridge is interesting:

- ▶ The path via bridge 5 and bridge 3 creates the same root path costs as the path via bridge 4 and bridge 2.
- ▶ STP selects the path using the bridge that has the lowest MAC address in the bridge identification (bridge 4 in the illustration).
- ▶ There are also 2 paths between bridge 6 and bridge 4. The port identifier is decisive here (Port 1 < Port 3).

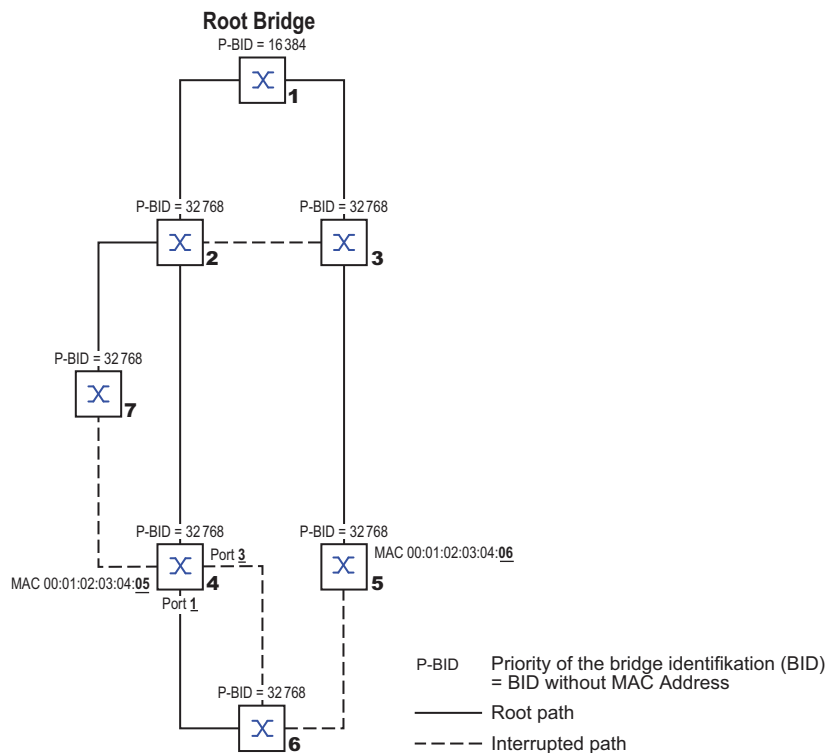

Figure 47: Example of determining the root path

Note: Because the Administrator does not change the default values for the priorities of the bridges in the bridge identifier, apart from the value for the root bridge, the MAC address in the bridge identifier alone determines which bridge becomes the new root bridge if the current root bridge goes down.

■ Example of manipulating the root path

You can use the network plan (see figure 48) to follow the flow chart (see figure 46) for determining the root path. The Administrator has performed the following:

- Left the default value of 32768 (8000H) for every bridge apart from bridge 1 and bridge 5, and
- assigned to bridge 1 the value 16384 (4000H), thus making it the root bridge.
- To bridge 5 he assigned the value 28672 (7000H).

The protocol blocks the path between bridge 2 and bridge 3 as a connection from bridge 3 via bridge 2 to the root bridge would mean higher path costs.

The path from bridge 6 to the root bridge is interesting:

- ▶ The bridges select the path via bridge 5 because the value 28672 for the priority in the bridge identifier is smaller than value 32768.

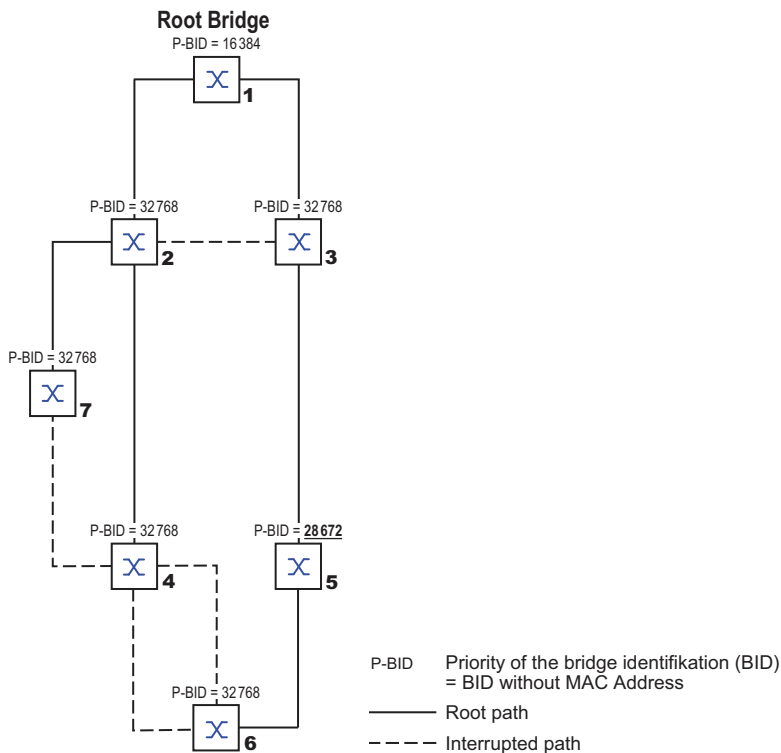

Figure 48: Example of manipulating the root path

■ Example of manipulating the tree structure

The Management Administrator soon discovers that this configuration with bridge 1 as the root bridge is invalid. On the paths from bridge 1 to bridge 2 and bridge 1 to bridge 3, the control packets which the root bridge sends to all other bridges add up.

If the Management Administrator configures bridge 2 as the root bridge, the burden of the control packets on the subnetworks is distributed much more evenly. The result is the configuration shown here (see figure 49). The path costs for most of the bridges to the root bridge have decreased.

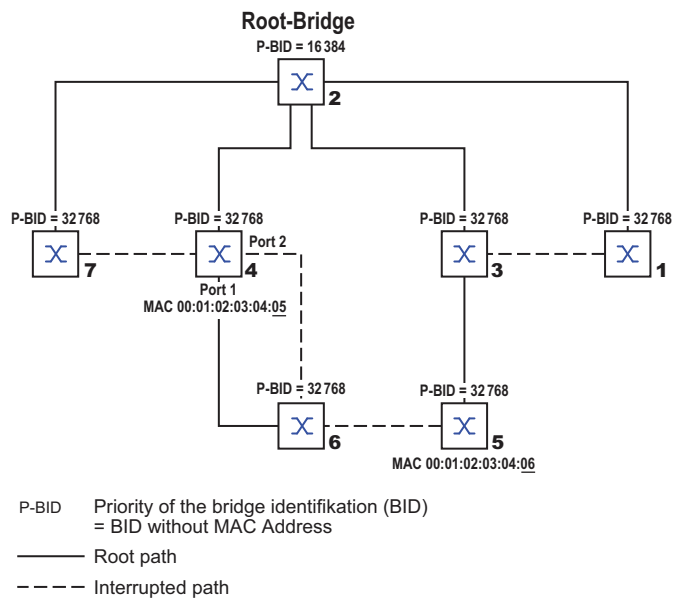

Figure 49: Example of manipulating the tree structure

12.6.4 The Rapid Spanning Tree Protocol

The RSTP uses the same algorithm for determining the tree structure as STP. RSTP merely changes parameters, and adds new parameters and mechanisms that speed up the reconfiguration if a link or bridge becomes inoperable.

The ports play a significant role in this context.

■ Port roles

RSTP assigns each bridge port one of the following roles (see figure 50):

- ▶ **Root Port:**
This is the port at which a bridge receives data packets with the lowest path costs from the root bridge.
If there are multiple ports with equally low path costs, the bridge ID of the bridge that leads to the root (designated bridge) decides which of its ports is given the role of the root port by the bridge further away from the root.
If a bridge has multiple ports with equally low path costs to the same bridge, the bridge uses the port ID of the bridge leading to the root (designated bridge) to decide which port it selects locally as the root port (see figure 46).
The root bridge itself does not have a root port.
- ▶ **Designated port:**
The bridge in a network segment that has the lowest root path costs is the designated bridge. If more than 1 bridge has the same root path costs, the bridge with the smallest value bridge identifier becomes the designated bridge. The designated port on this bridge is the port that connects a network segment leading away from the root bridge. If a bridge is connected to a network segment with more than one port (via a hub, for example), the bridge gives the role of the designated port to the port with the better port ID.
- ▶ **Edge port**
Every network segment with no additional RSTP bridges is connected with exactly one designated port. In this case, this designated port is also an edge port. The distinction of an edge port is the fact that it does not receive any RST BPDUs (Rapid Spanning Tree Bridge Protocol Data Units).
- ▶ **Alternate port**
This is a blocked port that takes over the task of the root port if the connection to the root bridge is lost. The alternate port provides a backup connection to the root bridge.
- ▶ **Backup port**
This is a blocked port that serves as a backup in case the connection to the designated port of this network segment (without any RSTP bridges) is lost
- ▶ **Disabled port**
This is a port that does not participate in the Spanning Tree Operation, that means, the port is switched off or does not have any connection.

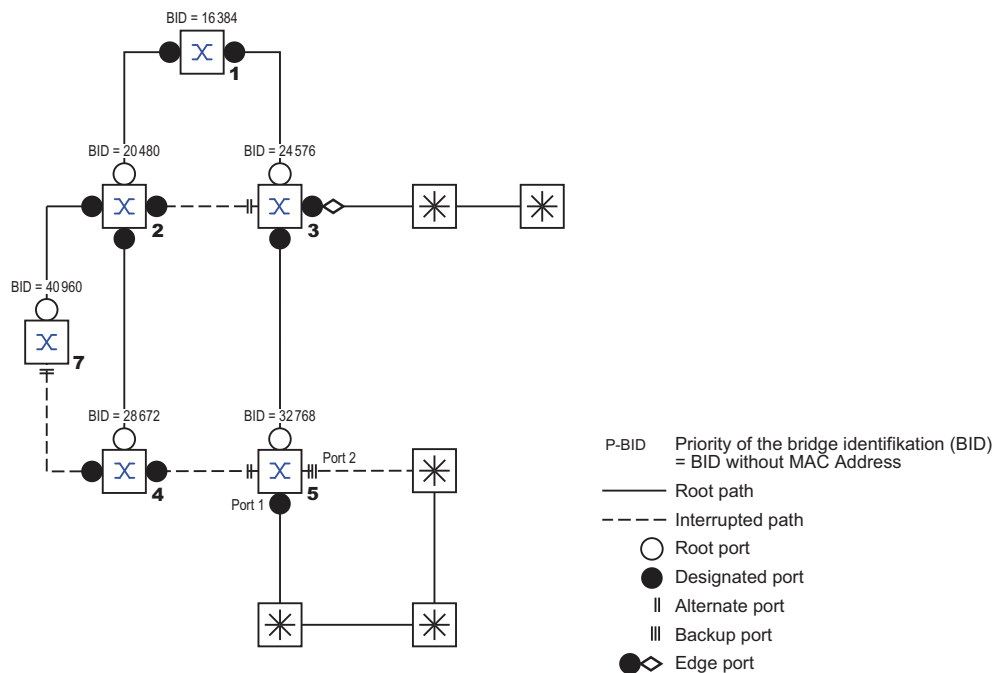

Figure 50: Port role assignment

■ Port states

Depending on the tree structure and the state of the selected connection paths, the RSTP assigns the ports their states.

| STP port state | Administrative bridge port state | MAC Operational | RSTP Port state | Active topology (port role) |
|----------------|----------------------------------|-----------------|-------------------------|------------------------------|
| DISABLED | Disabled | FALSE | Discarding ^a | Excluded (disabled) |
| DISABLED | Enabled | FALSE | Discarding ^a | Excluded (disabled) |
| BLOCKING | Enabled | TRUE | Discarding ^b | Excluded (alternate, backup) |
| LISTENING | Enabled | TRUE | Discarding ^b | Included (root, designated) |
| LEARNING | Enabled | TRUE | Learning | Included (root, designated) |
| FORWARDING | Enabled | TRUE | Forwarding | Included (root, designated) |

Table 23: Relationship between port state values for STP and RSTP

a. The dot1d-MIB displays "Disabled"

b. The dot1d-MIB displays "Blocked"

Meaning of the RSTP port states:

- ▶ Disabled: Port does not belong to the active topology
- ▶ Discarding: No address learning in FDB, no data traffic except for STP-BPDUs
- ▶ Learning: Address learning active (FDB), no data traffic apart from STP-BPDUs
- ▶ Forwarding: Address learning active (FDB), sending and receiving of all packet types (not only STP-BPDUs)

■ Spanning Tree Priority Vector

To assign roles to the ports, the RSTP bridges exchange configuration information with each other. This information is known as the Spanning Tree Priority Vector. It is part of the RSTP BPDUs and contains the following information:

- ▶ Bridge identification of the root bridge
- ▶ Root path costs of the sending bridge
- ▶ Bridge identification of the sending bridge
- ▶ Port identifiers of the ports through which the message was sent
- ▶ Port identifiers of the ports through which the message was received

Based on this information, the bridges participating in RSTP are able to determine port roles themselves and define the port states of their own ports.

■ Fast reconfiguration

Why can RSTP react faster than STP to an interruption of the root path?

- ▶ Introduction of edge-ports:
During a reconfiguration, RSTP switches an edge port into the transmission mode after three seconds (default setting) and then waits for the “Hello Time” to elapse, to be sure that no bridge sending BPDUs is connected.
When the user ensures that a end device is connected at this port and will remain connected, there are no waiting times at this port in the case of a reconfiguration.
- ▶ Introduction of alternate ports:
As the port roles are already distributed in normal operation, a bridge can immediately switch from the root port to the alternate port after the connection to the root bridge is lost.
- ▶ Communication with neighboring bridges (point-to-point connections):
Decentralized, direct communication between neighboring bridges enables reaction without wait periods to status changes in the spanning tree topology.
- ▶ Address table:
With STP, the age of the entries in the FDB determines the updating of communication. RSTP immediately deletes the entries in those ports affected by a reconfiguration.
- ▶ Reaction to events:
Without having to adhere to any time specifications, RSTP immediately reacts to events such as connection interruptions, connection reinstatements, etc.

Note: The downside of this fast reconfiguration is the possibility that data packages could be duplicated and/or arrive at the recipient in the wrong order during the reconfiguration phase of the RSTP topology. If this is unacceptable for your application, use the slower Spanning Tree Protocol or select one of the other, faster redundancy procedures described in this manual.

■ STP compatibility mode

The STP compatibility mode allows you to operate RSTP devices in networks with old installations. If an RSTP device detects an older STP device, it switches on the STP compatibility mode at the relevant port.

12.6.5 Configuring the device

RSTP configures the network topology completely independently. The device with the lowest bridge priority automatically becomes the root bridge. However, to define a specific network structure regardless, you specify a device as the root bridge. In general, a device in the backbone takes on this role.

- Set up the network to meet your requirements, initially without redundant lines.
- You deactivate the flow control on the participating ports.
If the flow control and the redundancy function are active at the same time, there is a risk that the redundancy function will not operate as intended. (Default setting: flow control deactivated globally and activated on all ports.)
- Switch MRP off on all devices.
- Switch Spanning Tree on on all devices in the network.
In the state on delivery, Spanning Tree is switched on on the device.

- Open the *Switching > L2-Redundancy > Spanning Tree > Global* dialog.
- Enable the function.
- To save the changes temporarily, click the button.

| | |
|---|--|
| <pre>enable configure spanning-tree operation show spanning-tree global</pre> | <p>Change to the Privileged EXEC mode.</p> <p>Change to the Configuration mode.</p> <p>Enables Spanning Tree.</p> <p>Displays the parameters for checking.</p> |
|---|--|

- Now connect the redundant lines.
- Define the settings for the device that takes over the role of the root bridge.
 - In the *Priority* field you enter a numerically lower value.
The bridge with the numerically lowest bridge ID has the highest priority and becomes the root bridge of the network.
 - To save the changes temporarily, click the button.

| | |
|--|---|
| <pre>spanning-tree mst priority 0 <0..61440 in 4096er-Schritten></pre> | <p>Specifies the bridge priority of the device.</p> |
|--|---|

After saving, the dialog shows the following information:

- The *Bridge is root* checkbox is marked.
- The *Root port* field shows the value 0.0.
- The *Root path cost* field shows the value 0.

| | |
|--------------------------------------|--|
| <pre>show spanning-tree global</pre> | <p>Displays the parameters for checking.</p> |
|--------------------------------------|--|

- If applicable, change the values in the *Forward delay [s]* and *Max age* fields.
 - The root bridge transmits the changed values to the other devices.
- To save the changes temporarily, click the button.

`spanning-tree forward-time <4..30>`

Specifies the delay time for the status change in seconds.

`spanning-tree max-age <6..40>`

Specifies the maximum permissible branch length, for example the number of devices to the root bridge.

`show spanning-tree global`

Displays the parameters for checking.

Note: The parameters *Forward delay [s]* and *Max age* have the following relationship:

$$\textit{Forward delay [s]} \geq (\textit{Max age}/2) + 1$$

If you enter values in the fields that contradict this relationship, the device replaces these values with the last valid values or with the default value.

Note: If possible, do not change the value in the “Hello Time” field.

- Check the following values in the other devices:
 - Bridge ID (bridge priority and MAC address) of the corresponding device and the root bridge.
 - Number of the device port that leads to the root bridge.
 - Path cost from the root port of the device to the root bridge.

`show spanning-tree global`

Displays the parameters for checking.

12.6.6 Guards

The device allows you to activate various protection functions (guards) on the device ports. The following protection functions help protect your network from incorrect configurations, loops and attacks with STP-BPDUs:

- ▶ **BPDU Guard** – for manually specified edge ports (end device ports)
You activate this protection function globally in the device.

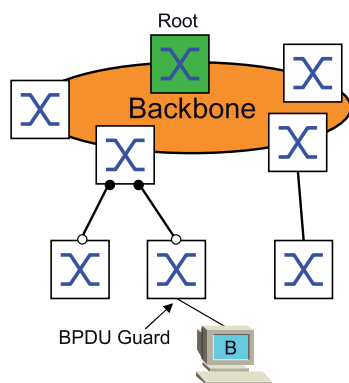

Terminal device ports do not normally receive any STP-BPDUs. If an attacker still attempts to feed in STP-BPDUs at this port, the device deactivates the device port.

- ▶ **Root Guard** – for designated ports
You activate this protection function separately for every device port.

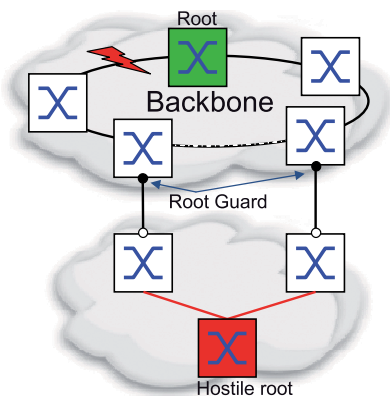

If a designated port receives an STP-BPDUs with better path information to the root bridge, the device discards the STP-BPDUs and sets the transmission state of the port to `discarding` instead of `root`. If there are no STP-BPDUs with better path information to the root bridge, after $2 \times \text{Hello time [s]}$ the device resets the state of the port to a value according to the port role.

- ▶ **TCN Guard** – for ports that receive STP-BPDUs with a Topology Change flag
You activate this protection function separately for every device port.

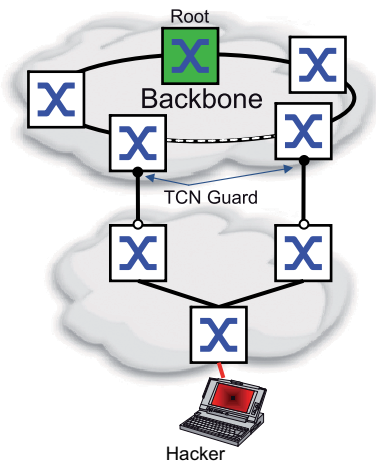

If the protection function is activated, the device ignores Topology Change flags in received STP-BPDUs. This does not change the content of the address table (FDB) of the device port. However, additional information in the BPDUs that changes the topology is processed by the device.

- ▶ Loop Guard – for root, alternate and backup ports
You activate this protection function separately for every device port.

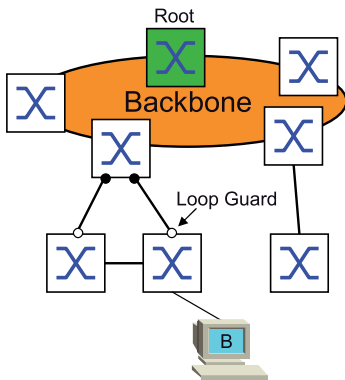

This protection function prevents the transmission status of a port from unintentionally being changed to *forwarding* if the port does not receive any more STP-BPDUs. If this situation occurs, the device designates the loop status of the port as inconsistent, but does not forward any data packets.

■ Activating the BPDU Guard

- Open the *Switching > L2-Redundancy > Spanning Tree > Global* dialog.
- Mark the *BPDU guard* checkbox.
- To save the changes temporarily, click the button.

```
enable
configure
spanning-tree bpdu-guard
show spanning-tree global
```

Change to the Privileged EXEC mode.
Change to the Configuration mode.
Activates the BPDU Guard.
Displays the parameters for checking.

- Open the *Switching > L2-Redundancy > Spanning Tree > Port* dialog.
- Switch to the *CIST* tab.
- For end device ports, mark the checkbox in the *Admin edge port* column.
- To save the changes temporarily, click the button.

| | |
|---|--|
| <pre>interface <x/y> spanning-tree edge-port show spanning-tree port x/y exit</pre> | <p>Change to the interface configuration mode of interface <x/y>.</p> <p>Designates the port as a terminal device port (edge port).</p> <p>Displays the parameters for checking.</p> <p>Leaves the interface mode.</p> |
|---|--|

If an edge port receives an STP-BPDU, the device behaves as follows:

- ▶ The device deactivates this port.
 - In the *Basic Settings > Port* dialog, *Configuration* tab, the checkbox for this port in the *Port on* column is unmarked.
- ▶ The device designates the port.

In the *Switching > L2-Redundancy > Spanning Tree > Port* dialog, *Guards* tab, the checkbox in the *BPDU guard effect* column is marked.

| | |
|--|--|
| <pre>show spanning-tree port x/y</pre> | <p>Displays the parameters of the port for checking. The value of the <i>BPDU guard effect</i> parameter is enabled.</p> |
|--|--|

To reset the status of the device port to the value *forwarding*, you proceed as follows:

- If the port is still receiving BPDUs:
 - Remove the manual definition as an edge port (end device port).
 - or
 - Deactivate the BPDU Guard.
- Activate the device port again.

■ Activating Root Guard / TCN Guard / Loop Guard

- Open the *Switching > L2-Redundancy > Spanning Tree > Port* dialog.
- Switch to the *Guards* tab.
- For designated ports, select the checkbox in the *Root guard* column.
- For ports that receive STP-BPDUs with a Topology Change flag, select the checkbox in the *TCN guard* column.
- For root, alternate or backup ports, mark the checkbox in the *Loop guard* column.

Note: The *Root guard* and *Loop guard* functions are mutually exclusive. If you try to activate the *Root guard* function while the *Loop guard* function is activated, the device deactivates the *Loop guard* function.

- To save the changes temporarily, click the button.

| | |
|---|---|
| <pre>enable configure interface <x/y> spanning-tree guard-root spanning-tree guard-tcn spanning-tree guard-loop exit show spanning-tree port x/y</pre> | <p>Change to the Privileged EXEC mode.</p> <p>Change to the Configuration mode.</p> <p>Change to the interface configuration mode of interface <x/y>.</p> <p>Switches the Root Guard on at the designated port.</p> <p>Switches the TCN Guard on at the port that receives STP-BPDUs with a Topology Change flag.</p> <p>Switches the Loop Guard on at a root, alternate or backup port.</p> <p>Leaves the interface mode.</p> <p>Displays the parameters of the port for checking.</p> |
|---|---|

12.6.7 Ring only mode

You use the *Ring only mode* function to recognize full-duplex connectivity and to configure the ports that are connected to the end stations. The *Ring only mode* function allows the device to transition to the 'forwarding' state, and suppress the Topology Change Notification PDUs.

■ Configuring the Ring only mode

When you activate the *Ring only mode* function on the ports, and the device ignores the message age of normal BDPUs, the device sends Topology Change messages with the message age of 1.

■ Example

The given example describes the configuration of the *Ring only mode* function.

- Open the *Switching > L2-Redundancy > Spanning Tree > Spanning Tree Global* dialog.
- In the *Ring only mode* frame, select the port 1/1 in the *First port* field.
- In the *Ring only mode* frame, select the port 1/2 in the *Second port* field.
- To activate the function, in the *Ring only mode* frame, mark the *Active* checkbox.
- To save the changes temporarily, click the button.

| | |
|---|--|
| enable | Change to the Privileged EXEC mode. |
| configure | Change to the Configuration mode. |
| spanning-tree ring-only-mode operation | Enable the <i>Ring only mode</i> function. |
| spanning-tree ring-only-mode first-port 1/1 | Specify port 1/1 as the first interface. |
| spanning-tree ring-only-mode second-port 1/2 | Specify port 1/2 as the second interface. |

12.6.8 RSTP over HSR

The RSTP over HSR function allows you to redundantly couple an RSTP network to an HSR ring.

By doing this:

- ▶ The device uses the logical port `hsr/1`.
- ▶ The device flushes the Proxy Node Table when the logical port `hsr/1` changes from the RSTP state to 'forwarding'.

■ **Configuring RSTP over HSR**

HSR allows a limited bandwidth. In case of redundancy, RSTP is configured in a way that the traffic is forwarded over the HSR ring only.

■ **Example**

You use the RSTP over HSR function to redundantly couple an RSTP network to an HSR ring.

- Open the *Switching > L2-Redundancy > Spanning Tree > Spanning Tree Port* dialog.
- In the *Port priority* column, specify the value 240 for port `hsr/1`.
- In the *Port path cost* column, specify the value 200000000 for port `hsr/1`.
- Enable the *Spanning Tree* function on port `hsr/1`.
In the *STP active* column, mark the checkbox for port `hsr/1`.

12.7 Link Aggregation

Link Aggregation using the single switch method helps you overcome 2 limitations with ethernet links, namely bandwidth, and redundancy.

The first problem that the Link Aggregation Group (LAG) function helps you with is bandwidth limitations of individual ports. LAG allows you to combine 2 or more links in parallel, creating 1 logical link between 2 devices. The parallel links increase the bandwidth for traffic between the 2 devices.

You typically use Link Aggregation on the network backbone. The function provides you an inexpensive way to incrementally increase bandwidth.

Furthermore, Link Aggregation provides for redundancy with a seamless failover. With 2 or more links configured in parallel, when a link goes down, the other links in the group continue to forward traffic.

The default settings for a new Link Aggregation instance are as follows:

- ▶ In the *Active* column, the checkbox is marked.
- ▶ In the *Send trap (Link up/down)* column, the checkbox is marked.
- ▶ In the *Static link aggregation* column, the checkbox is unmarked.
- ▶ In the *Active ports (min.)* column, the value is 1.

12.7.1 Methods of Operation

The device operates on the Single Switch method. The Single Switch method provides you an inexpensive way to grow your network. The single switch method states that you need 1 device on each side of a link to provide the physical ports. The device balances the traffic load across the group member ports.

The device also uses the Same Link Speed method in which the group member ports are full-duplex, point-to-point links having the same transmission rate. The first port the user adds to the group is the master port and determines the bandwidth for the other member ports of the Link Aggregation Group.

The device allows you to set up up to 1 Link Aggregation groups. The number of useable ports per Link Aggregation group depends on the device.

12.7.2 Link Aggregation Example

Connect multiple workstations using one aggregated link group between switch 1 and 2. By aggregating multiple links, higher speeds are achievable without a hardware upgrade.

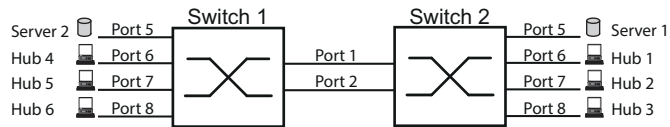



Figure 51: Link Aggregation Switch to Switch Network

Use the following steps to setup switch 1 and 2 in the graphical user interface.

- Open the *Switching > L2-Redundancy > Link Aggregation* dialog.
- Click the  button.
The dialog displays the *Create* window.
- In the *Trunk port* drop-down list, select the instance number of the link aggregation group.
- In the *Port* drop-down list, select the port 1/1.
- Click the *Ok* button.
- Repeat the preceding steps and select the port 1/2.
- Click the *Ok* button.
- To save the changes temporarily, click the  button.

enable

Change to the Privileged EXEC mode.

configure

Change to the Configuration mode.

link-aggregation add lag/1

Creates a Link Aggregation Group lag/1.

link-aggregation modify lag/1 addport 1/1

Adds port 1/1 to the Link Aggregation Group.

link-aggregation modify lag/1 addport 1/2

Adds port 1/2 to the Link Aggregation Group.

12.8 Link Backup

Link Backup provides a redundant link for traffic on Layer 2 devices. When the device detects an error on the primary link, then the device transfers traffic to the backup link. You typically use Link Backup in service-provider or enterprise networks.

You set up the backup links in pairs, one as a primary and one as a backup. When providing redundancy for enterprise networks for example, the device allows you to set up more than 1 pair. The maximum number of link backup pairs is: total number of physical ports / 2. Furthermore, the device sends an SNMP trap when the state of a port participating in a link backup pair changes.

When configuring link backup pairs remember the following rules:

- ▶ A link pair consists of any combination of physical ports. For example, when 1 port is a 100 Mbit port and the other is a 1000 Mbit SFP port.
- ▶ A specific port is a member of 1 link backup pair at any given time.
- ▶ Verify that the ports of a link backup pair are members of the same VLAN with the same VLAN ID. When the primary port or backup port is a member of a VLAN then, assign the second port of the pair to the same VLAN.

The default setting for this function is inactive without any link backup pairs.

Note: Verify that the Spanning Tree Protocol is disabled on the Link Backup ports.

12.8.1 Fail Back Description

Link Backup also allows you to set up a Fail Back option. When you activate the fail back function and the primary link returns to normal operation, the device first blocks traffic on the backup port and then forwards traffic on the primary port. This process helps protect the device from causing loops in the network.

When the primary port returns to the link up and active state, the device supports 2 modes of operation:

- ▶ When you inactivate *Fail back*, the primary port remains in the blocking state until the backup link fails.
- ▶ When you activate *Fail back*, and after the *Fail back delay [s]* timer expires, the primary port returns to the forwarding state and the backup port changes to down.

In the cases listed above, the port forcing its link to forward traffic, first sends a "flush FDB" packet to the remote device. The flush packet helps the remote device quickly relearn the MAC addresses.

12.8.2 Example Configuration

In the example network below, you connect ports 2/3 and 2/4 on switch A to the uplink switches B and C. When you set up the ports as a Link Backup pair, 1 of the ports forwards traffic and the other port is in the blocking mode.

The primary, port 2/3 on switch A, is the active port and is forwarding traffic to port 1 on switch B. Port 2/4 on switch A is the backup port and is blocking traffic.

When switch A disables port 2/3 because of a detected error, then port 2/4 on switch A starts forwarding traffic to port 2 on switch C.

When port 2/3 returns to the active state, “no shutdown“, with *Fail back* activated, and *Fail back delay [s]* set to 30 seconds. After the timer expires, port 2/4 first blocks the traffic and then port 2/3 starts forwarding the traffic.

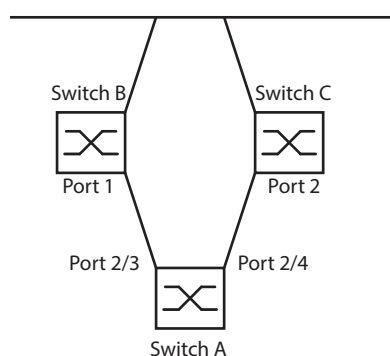



Figure 52: Link Backup example network

The following tables contain examples of parameters for Switch A set up.

- Open the *Switching > L2-Redundancy > Link Backup* dialog.
- Enter a new Link Backup pair in the table:
 - Click the  button.
The dialog displays the *Create* window.
 - In the *Primary port* drop-down list, select port 2/3.
In the *Backup port* drop-down list, select port 2/4.
 - Click the *Ok* button.
- In the *Description* textbox, enter `Link_Backup_1` as the name for the backup pair.
- To activate the Fail Back function for the link backup pair, mark the *Fail back* checkbox.
- Set the fail back timer for the link backup pair, enter `30 s` in *Fail back delay [s]*.
- To activate the link backup pair, mark the *Active* checkbox.
- To enable the function, select the *On* radio button in the *Operation* frame.

| | |
|---|--|
| <pre>enable configure interface 2/3 link-backup add 2/4 link-backup modify 2/4 description Link_Backup_1 link-backup modify 2/4 failback-status enable link-backup modify 2/4 failback-time 30 link-backup modify 2/4 status enable exit link-backup operation</pre> | <p>Change to the Privileged EXEC mode.</p> <p>Change to the Configuration mode.</p> <p>Change to the interface configuration mode of interface 2/3.</p> <p>Creates a Link Backup instance where port 2/3 is the primary port and port 2/4 is the backup port.</p> <p>Specifies the string <code>Link_Backup_1</code> as the name of the backup pair.</p> <p>Enables the fail back timer.</p> <p>Specifies the fail back delay time as 30 s.</p> <p>Enables the Link Backup instance.</p> <p>Change to the Configuration mode.</p> <p>Enables the <i>Link Backup</i> function globally on the device.</p> |
|---|--|

13 Operation diagnosis

The device provides you with the following diagnostic tools:

- ▶ Sending SNMP traps
- ▶ Monitoring the Device Status
- ▶ Out-of-Band signaling using the signal contact
- ▶ Port status indication
- ▶ Event counter at port level
- ▶ Detecting non-matching duplex modes
- ▶ Auto-Disable
- ▶ Displaying the SFP status
- ▶ Topology discovery
- ▶ Detecting IP address conflicts
- ▶ Detecting loops
- ▶ Reports
- ▶ Monitoring data traffic on a port (port mirroring)
- ▶ Syslog
- ▶ Event log
- ▶ Cause and action management during selftest

13.1 Sending SNMP traps

The device immediately reports unusual events which occur during normal operation to the network management station. This is done by messages called SNMP traps that bypass the polling procedure (“polling” means querying the data stations at regular intervals). SNMP traps allow you to react quickly to unusual events.

Examples of such events are:

- ▶ Hardware reset
- ▶ Changes to the configuration
- ▶ Segmentation of a port

The device sends SNMP traps to various hosts to increase the transmission reliability for the messages. The unacknowledged SNMP trap message consists of a packet containing information about an unusual event.

The device sends SNMP traps to those hosts entered in the trap destination table. The device allows you to configure the trap destination table with the network management station using SNMP.

13.1.1 List of SNMP traps

The following table displays possible SNMP traps sent by the device.

| Name of the SNMP trap | Meaning |
|---|---|
| authenticationFailure | This is sent if a station attempts to access an agent without authorisation. |
| coldStart | Sent after a restart. |
| hm2DevMonSenseExtNvmRemoval | This is sent when the external memory has been removed. |
| linkDown | This is sent if the connection to a port is interrupted. |
| linkUp | This is sent when connection is established to a port. |
| hm2DevMonSensePSState | This is sent if the status of a power supply unit changes. |
| hm2SigConStateChange | This is sent if the status of the signal contact changes in the operation monitoring. |
| newRoot | This is sent if the sending agent becomes the new root of the spanning tree. |
| topologyChange | This is sent when the port changes from blocking to forwarding or from forwarding to blocking. |
| alarmRisingThreshold | This is sent if the RMON input exceeds its upper threshold. |
| alarmFallingThreshold | This is sent if the RMON input goes below its lower threshold. |
| hm2AgentPortSecurityViolation | This is sent if a MAC address detected on this port does not match the current settings of the parameter <code>hm2AgentPortSecurityEntry</code> . |
| hm2DiagSelftestActionTrap | Sent if a self test for the four categories "task", "resource", "software", and "hardware" is performed according to the configured settings. |
| hm2MrpReconfig | This is sent if the configuration of the MRP ring changes. |
| hm2DiagIfaceUtilizationTrap | This is sent if the threshold of the interface exceeds or undercuts the upper or lower threshold specified. |
| hm2LogAuditStartNextSector | This trap is sent if the audit trail after completing one sector starts a new one. |
| hm2PtpSynchronizationChance | This is sent if the status of the PTP synchronization has been changed. |
| hm2ConfigurationSavedTrap | This is sent after the device has successfully saved its configuration locally. |
| hm2ConfigurationChangedTrap | This is sent when you change the configuration of the device for the first time after it has been saved locally. |
| hm2PlatformStpInstanceLoopInconsistentStartTrap | This is sent if the port in this STP instance changes to the "loop inconsistent" status. |
| hm2PlatformStpInstanceLoopInconsistentEndTrap | This is sent if the port in this STP instance leaves the "loop inconsistent" status when receiving a BPDU packet. |

Table 24: Possible SNMP traps

13.1.2 SNMP traps for configuration activity



After you save a configuration in the memory, the device sends a `hm2ConfigurationSavedTrap`. This SNMP trap contains both the Non-Volatile Memory (NVM) and External Non-Volatile Memory (ENVM) state variables indicating whether the running configuration is in sync with the NVM, and with the ENVM. You can also trigger this SNMP trap by copying a configuration file to the device, replacing the active saved configuration.

Furthermore, the device sends a `hm2ConfigurationChangedTrap`, whenever you change the local configuration, indicating a mismatch between the running and saved configuration.

13.1.3 SNMP trap setting

The device offers you the option of sending an SNMP trap as a reaction to specific events. Create at least 1 trap destination that receives SNMP traps.

Perform the following steps:

- Open the *Diagnostics > Status Configuration > Alarms (Traps)* dialog.
- Click the  button.
The dialog displays the *Create* window.
- In the *Name* frame, specify the name that the device uses to identify itself as the source of the SNMP trap.
- In the *Address* frame, specify the IP address of the trap destination to which the device sends the SNMP traps.
- In the *Active* column you select the entries that the device should take into account when it sends SNMP traps.
- To save the changes temporarily, click the  button.

For example, in the following dialogs you specify when the device triggers an SNMP trap:

- ▶ *Basic Settings > Port* dialog
- ▶ *Network Security > Port Security* dialog
- ▶ *Switching > L2-Redundancy > Link Aggregation* dialog
- ▶ *Diagnostics > Status Configuration > Device Status* dialog
- ▶ *Diagnostics > Status Configuration > Security Status* dialog
- ▶ *Diagnostics > Status Configuration > Signal Contact* dialog
- ▶ *Diagnostics > Status Configuration > MAC Notification* dialog
- ▶ *Diagnostics > System > IP Address Conflict Detection* dialog
- ▶ *Diagnostics > System > Selftest* dialog
- ▶ *Diagnostics > Ports > Port Monitor* dialog

13.1.4 ICMP messaging

The device allows you to use the Internet Control Message Protocol (ICMP) for diagnostic applications, for example ping and trace route. The device also uses ICMP for time-to-live and discarding messages in which the device forwards an ICMP message back to the packet source device.

Use the ping network tool to test the path to a particular host across an IP network. The traceroute diagnostic tool displays paths and transit delays of packets across a network.

13.2 Monitoring the Device Status

The device status provides an overview of the overall condition of the device. Many process visualization systems record the device status for a device in order to present its condition in graphic form.

The device displays its current status as `error` or `ok` in the *Device status* frame. The device determines this status from the individual monitoring results.

The device enables you to:

- ▶ Out-of-Band signalling using a signal contact
- ▶ signal the changed device status by sending an SNMP trap
- ▶ detect the device status in the *Basic Settings > System* dialog of the graphical user interface
- ▶ query the device status in the Command Line Interface

The *Global* tab of the *Diagnostics > Status Configuration > Device Status* dialog allows you to configure the device to send a trap to the management station for the following events:

- ▶ Incorrect supply voltage
 - at least one of the 2 supply voltages is not operating
 - the internal supply voltage is not operating
- ▶ When the device is operating outside of the user-defined temperature threshold
- ▶ Loss of the redundancy (in ring manager mode)
- ▶ The interruption of link connection(s)
 - Configure at least one port for this feature. In the *Port* tab of the *Diagnostics > Status Configuration > Device Status* dialog in the *Propagate connection error* row, you specify which ports the device signals if the link is down.
- ▶ The removal of the external memory.
- ▶ The configuration in the external memory is out-of-sync with the configuration in the device.

Select the corresponding entries to decide which events the device status includes.

Note: With a non-redundant voltage supply, the device reports the absence of a supply voltage. To disable this message, feed the supply voltage over both inputs or ignore the monitoring.

13.2.1 Events which can be monitored

| Name | Meaning |
|-------------------------|--|
| Temperature | If the temperature exceeds or falls below the value specified. |
| Ring redundancy | Enable this function to monitor if ring redundancy is present. |
| Connection errors | Enable this function to monitor every port link event in which the <i>Propagate connection error</i> checkbox is active. |
| External memory removal | Enable this function to monitor the presence of an external storage device. |

Table 25: *Device Status* events

| Name | Meaning |
|-----------------------------|--|
| External memory not in sync | The device monitors synchronization between the device configuration and the configuration stored on the ENVM. |
| Power supply | Enable this function to monitor the power supply. |

Table 25: *Device Status events (cont.)*

13.2.2 Configuring the Device Status

Perform the following steps:

- Open the *Diagnostics > Status Configuration > Device Status* dialog, *Global* tab.
- For the parameters to be monitored, mark the checkbox in the *Monitor* column.
- To send an SNMP trap to the management station, activate the *Send trap* function in the *Traps* frame.
- In the *Diagnostics > Status Configuration > Alarms (Traps)* dialog, create at least 1 trap destination that receives SNMP traps.
- To save the changes temporarily, click the button.
- Open the *Basic Settings > System* dialog.
- To monitor the temperature, at the bottom of the *System data* frame, you specify the temperature thresholds.
- To save the changes temporarily, click the button.

| | |
|--|---|
| enable | Change to the Privileged EXEC mode. |
| configure | Change to the Configuration mode. |
| device-status trap | Sending an SNMP trap if the device status changes. |
| device-status monitor envm-not-in-sync | Monitors the configuration profiles in the device and in the external memory. The <i>Device status</i> changes to <i>error</i> in the following situations: <ul style="list-style-type: none"> – The configuration profile solely exists in the device. – The configuration profile in the device differs from the configuration profile in the external memory. |
| device-status monitor envm-removal | Monitors the active external memory. The value in the <i>Device status</i> frame changes to <i>error</i> if you remove the active external memory from the device. |
| device-status monitor power-supply 1 | Monitors the power supply unit 1. The value in the <i>Device status</i> frame changes to <i>error</i> if the device has a detected power supply fault. |
| device-status monitor ring-redundancy | Monitors the ring redundancy. The <i>Device status</i> changes to <i>error</i> in the following situations: <ul style="list-style-type: none"> – The redundancy function becomes active (loss of redundancy reserve). – The device is a normal ring participant and detects an error in its settings. |
| device-status monitor temperature | Monitors the temperature in the device. The value in the <i>Device status</i> frame changes to <i>error</i> if the temperature exceeds or falls below the specified limit. |

In order to enable the device to monitor an active link without a connection, first enable the global function, then enable the individual ports.

Perform the following steps:

- Open the *Diagnostics > Status Configuration > Device Status* dialog, *Global* tab.
- For the *Connection errors* parameter, mark the checkbox in the *Monitor* column.
- Open the *Diagnostics > Status Configuration > Device Status* dialog, *Port* tab.
- For the *Propagate connection error* parameter, mark the checkbox in the column of the ports to be monitored.
- To save the changes temporarily, click the button.

```
enable
configure
device-status monitor link-failure
```

Change to the Privileged EXEC mode.

Change to the Configuration mode.

Monitors the ports/interfaces link. The value in the *Device status* frame changes to `error` if the link interrupts on a monitored port/interface.

```
interface 1/1
device-status link-alarm
```

Change to the interface configuration mode of interface 1/1.

Monitors the port/interface link. The value in the *Device status* frame changes to `error` if the link interrupts on the port/interface.

Note: The above CLI commands activate monitoring and trapping for the supported components. If you want to activate or deactivate monitoring for individual components, you will find the corresponding syntax in the “Command Line Interface” reference manual or in the help of the CLI console. (Enter a question mark ? for the CLI prompt.)

13.2.3 Displaying the Device Status

Perform the following steps:

- Open the *Basic Settings > System* dialog.

```
show device-status all
```

In the EXEC Privilege mode: Displays the device status and the setting for the device status determination.

13.3 Security Status

The Security Status provides an overview of the overall security of the device. Many processes aid in system visualization by recording the security status of the device and then presenting its condition in graphic form. The device displays the overall security status in the *Basic Settings > System* dialog, *Security status* frame.

In the *Global* tab of the *Diagnostics > Status Configuration > Security Status* dialog the device displays its current status as `error` or `ok` in the *Security status* frame. The device determines this status from the individual monitoring results.

The device enables you to:

- ▶ Out-of-Band signalling using a signal contact
- ▶ signal the changed security status by sending an SNMP trap
- ▶ detect the security status in the *Basic Settings > System* dialog of the graphical user interface
- ▶ query the security status in the Command Line Interface

13.3.1 Events which can be monitored

Specify the events that the device monitors.

For the corresponding parameter, mark the checkbox in the *Monitor* column.

| Name | Meaning |
|--|--|
| Password default settings unchanged | After installation change the passwords to increase security. The device monitors if the default passwords remain unchanged. |
| Min. password length < 8 | Create passwords more than 8 characters long to maintain a high security posture. When active the device monitors the <i>Min. password length</i> setting. |
| Password policy settings deactivated | The device monitors the settings located in the <i>Device Security > User Management</i> dialog for password policy requirements. |
| User account password policy check deactivated | The device monitors the settings of the <i>Policy check</i> checkbox. When <i>Policy check</i> is inactive, the device sends an SNMP trap. |
| Telnet server active | The device monitors when you enable the Telnet function. |
| HTTP server active | The device monitors when you enable the HTTP connection function. |
| SNMP unencrypted | The device monitors when you enable the SNMPv1 or v2 connection function. |
| Access to system monitor with V.24 possible | The device monitors the System Monitor status. |
| Saving the configuration profile on the external memory possible | The device monitors the possibility to save configurations to the external non-volatile memory. |
| Link interrupted on enabled device ports | The device monitors the link status of active ports. |
| Access with HiDiscovery possible | The device monitors when you enable the HiDiscovery read/write access function. |
| Load unencrypted config from external memory | The device monitors the security settings for loading the configuration from the external NVM. |
| IEC61850-MMS active | The device monitors the IEC 61850-MMS protocol activation setting. |
| Modbus TCP active | The device monitors the Modbus TCP/IP protocol activation setting. |
| Self-signed HTTPS certificate present | The device monitors the HTTPS server for self-created digital certificates. |

Table 26: *Security Status events*

13.3.2 Configuring the Security Status

Perform the following steps:

- Open the *Diagnostics > Status Configuration > Security Status* dialog, *Global* tab.
- For the parameters to be monitored, mark the checkbox in the *Monitor* column.
- To send an SNMP trap to the management station, activate the *Send trap* function in the *Traps* frame.
- To save the changes temporarily, click the button.
- In the *Diagnostics > Status Configuration > Alarms (Traps)* dialog, create at least 1 trap destination that receives SNMP traps.

| | |
|--|---|
| enable | Change to the Privileged EXEC mode. |
| configure | Change to the Configuration mode. |
| security-status monitor pwd-change | Monitors the password for the locally set up user accounts <i>user</i> and <i>admin</i> . The value in the <i>Security status</i> frame changes to <i>error</i> if the password for the <i>user</i> or <i>admin</i> user accounts is the default setting. |
| security-status monitor pwd-min-length | Monitors the value specified in the <i>Min. password length</i> policy. The value in the <i>Security status</i> frame changes to <i>error</i> if the value for the <i>Min. password length</i> policy is less than 8. |
| security-status monitor pwd-policy-config | Monitors the password policy settings. The value in the <i>Security status</i> frame changes to <i>error</i> if the value for at least one of the following policies is specified as 0. <ul style="list-style-type: none"> – <i>Upper-case characters (min.)</i> – <i>Lower-case characters (min.)</i> – <i>Digits (min.)</i> – <i>Special characters (min.)</i> |
| security-status monitor pwd-policy-inactive | Monitors the password policy settings. The value in the <i>Security status</i> frame changes to <i>error</i> if the value for at least one of the following policies is specified as 0. |
| security-status monitor telnet-enabled | Monitors the Telnet server. The value in the <i>Security status</i> frame changes to <i>error</i> if you enable the Telnet server. |
| security-status monitor http-enabled | Monitors the HTTP server. The value in the <i>Security status</i> frame changes to <i>error</i> if you enable the HTTP server. |
| security-status monitor snmp-unsecure | Monitors the SNMP server. The value in the <i>Security status</i> frame changes to <i>error</i> if at least one of the following conditions applies: <ul style="list-style-type: none"> – The <i>SNMPv1</i> function is enabled. – The <i>SNMPv2</i> function is enabled. – The encryption for <i>SNMPv3</i> is disabled. You enable the encryption in the <i>Device Security > User Management</i> dialog, in the <i>SNMP encryption type</i> field. |
| security-status monitor sysmon-enabled | To monitor the activation of System Monitor 1 on the device. |
| security-status monitor extnvm-upd-enabled | To monitor the activation of the external non volatile memory update. |
| security-status monitor iec61850-mms-enabled | Monitors the <i>IEC61850-MMS</i> function. The value in the <i>Security status</i> frame changes to <i>error</i> if you enable the <i>IEC61850-MMS</i> function. |
| security-status trap | Sending an SNMP trap if the device status changes. |

In order to enable the device to monitor an active link without a connection, first enable the global function, then enable the individual ports.

Perform the following steps:

- Open the *Diagnostics > Status Configuration > Security Status* dialog, *Global* tab.
- For the *Link interrupted on enabled device ports* parameter, mark the checkbox in the *Monitor* column.
- To save the changes temporarily, click the button.
- Open the *Diagnostics > Status Configuration > Device Status* dialog, *Port* tab.
- For the *Link interrupted on enabled device ports* parameter, mark the checkbox in the column of the ports to be monitored.
- To save the changes temporarily, click the button.

| | |
|---|--|
| enable | Change to the Privileged EXEC mode. |
| configure | Change to the Configuration mode. |
| security-status monitor no-link-enabled | Monitors the link on active ports. The value in the <i>Security status</i> frame changes to <code>error</code> if the link interrupts on an active port. |
| interface 1/1 | Change to the interface configuration mode of interface 1/1. |
| security-status monitor no-link | Monitors the link on interface/port 1. |

13.3.3 Displaying the Security Status

Perform the following steps:

- Open the *Basic Settings > System* dialog.

| | |
|--------------------------|--|
| show security-status all | In the EXEC Privilege mode, display the security status and the setting for the security status determination. |
|--------------------------|--|

13.4 Out-of-Band signaling

The device uses the signal contact to control external devices and monitor device functions. Function monitoring enables you to perform remote diagnostics.

The device reports the operating status using a break in the potential-free signal contact (relay contact, closed circuit) for the selected mode. The device monitors the following functions:

- ▶ Incorrect supply voltage
 - at least one of the 2 supply voltages is not operating
 - the internal supply voltage is not operating
- ▶ When the device is operating outside of the user-defined temperature threshold
- ▶ Events for ring redundancy
 - Loss of the redundancy (in ring manager mode)
 - In the default setting, ring redundancy monitoring is inactive. The device is a normal ring participant and detects an error in the local configuration.
- ▶ The interruption of link connection(s)
 - Configure at least one port for this feature. In the *Propagate connection error* frame, you specify which ports the device signals if the link is down. In the default setting, link monitoring is inactive.
- ▶ The removal of the external memory.
- ▶ The configuration on the external memory does not match that in the device.

Select the corresponding entries to decide which events the device status includes.

Note: With a non-redundant voltage supply, the device reports the absence of a supply voltage. To disable this message, feed the supply voltage over both inputs or ignore the monitoring.

13.4.1 Controlling the Signal contact

With the `Manual setting` mode you control this signal contact remotely.

Application options:

- ▶ Simulation of an error detected during SPS error monitoring
- ▶ Remote control of a device using SNMP, such as switching on a camera

Perform the following steps:

- Open the *Diagnostics > Status Configuration > Signal Contact* dialog, *Global* tab.
- To control the signal contact manually, in the *Configuration* frame, *Mode* drop-down list, select the value `Manual setting`.
- To open the signal contact, you select the `open` radio button in the *Configuration* frame.
- To close the signal contact, you select the `close` radio button in the *Configuration* frame.
- To save the changes temporarily, click the button.

```
enable
configure
signal-contact 1 mode manual
signal-contact 1 state open
signal-contact 1 state closed
```

```
Change to the Privileged EXEC mode.
Change to the Configuration mode.
Select the manual setting mode for signal contact 1.
Open signal contact 1.
Close signal contact 1.
```

13.4.2 Monitoring the Device and Security Statuses

In the *Configuration* field, you specify which events the signal contact indicates.

- ▶ Device status
Using this setting the signal contact indicates the status of the parameters monitored in the *Diagnostics > Status Configuration > Device Status* dialog.
- ▶ Security status
Using this setting the signal contact indicates the status of the parameters monitored in the *Diagnostics > Status Configuration > Security Status* dialog.
- ▶ Device/Security status
Using this setting the signal contact indicates the status of the parameters monitored in the *Diagnostics > Status Configuration > Device Status* and the *Diagnostics > Status Configuration > Security Status* dialog.

■ Configuring the operation monitoring

Perform the following steps:

- Open the *Diagnostics > Status Configuration > Signal Contact* dialog, *Global* tab.
- To monitor the device functions using the signal contact, in the *Configuration* frame, specify the value `Monitoring correct operation` in the *Mode* field.
- For the parameters to be monitored, mark the checkbox in the *Monitor* column.
- To send an SNMP trap to the management station, activate the *Send trap* function in the *Traps* frame.
- To save the changes temporarily, click the button.
- In the *Diagnostics > Status Configuration > Alarms (Traps)* dialog, create at least 1 trap destination that receives SNMP traps.
- To save the changes temporarily, click the button.
- You specify the temperature thresholds for the temperature monitoring in the *Basic Settings > System* dialog.

| | |
|--|--|
| <code>enable</code> | Change to the Privileged EXEC mode. |
| <code>configure</code> | Change to the Configuration mode. |
| <code>signal-contact 1 monitor temperature</code> | Monitors the temperature in the device. The signal contact opens if the temperature exceeds / falls below the threshold values. |
| <code>signal-contact 1 monitor ring-redundancy</code> | Monitors the ring redundancy. The signal contact opens in the following situations: <ul style="list-style-type: none">– The redundancy function becomes active (loss of redundancy reserve).– The device is a normal ring participant and detects an error in its settings. |
| <code>signal-contact 1 monitor link-failure</code> | Monitors the ports/interfaces link. The signal contact opens if the link interrupts on a monitored port/interface. |
| <code>signal-contact 1 monitor envm-removal</code> | Monitors the active external memory. The signal contact opens if you remove the active external memory from the device. |
| <code>signal-contact 1 monitor envm-not-in-sync</code> | Monitors the configuration profiles in the device and in the external memory. The signal contact opens in the following situations: <ul style="list-style-type: none">– The configuration profile solely exists in the device.– The configuration profile in the device differs from the configuration profile in the external memory. |
| <code>signal-contact 1 monitor power-supply 1</code> | Monitors the power supply unit 1. The signal contact opens if the device has a detected power supply fault. |

| | |
|---|--|
| signal-contact 1 monitor module-removal 1 | Monitors module 1. The signal contact opens if you remove module 1 from the device. |
| signal-contact 1 trap | Enables the device to send an SNMP trap when the status of the operation monitoring changes. |
| no signal-contact 1 trap | Disabling the SNMP trap |

In order to enable the device to monitor an active link without a connection, first enable the global function, then enable the individual ports.

Perform the following steps:

- In the *Monitor* column, activate the *Link interrupted on enabled device ports* function.
- Open the *Diagnostics > Status Configuration > Device Status* dialog, *Port* tab.

| | |
|---------------------------------------|--|
| enable | Change to the Privileged EXEC mode. |
| configure | Change to the Configuration mode. |
| signal-contact 1 monitor link-failure | Monitors the ports/interfaces link. The signal contact opens if the link interrupts on a monitored port/interface. |
| interface 1/1 | Change to the interface configuration mode of interface 1/1. |
| signal-contact 1 link-alarm | Monitors the port/interface link. The signal contact opens if the link interrupts on the port/interface. |

■ Events which can be monitored

| Name | Meaning |
|--------------------------------------|--|
| Temperature | If the temperature exceeds or falls below the value specified. |
| Ring redundancy | Enable this function to monitor if ring redundancy is present. |
| Connection errors | Enable this function to monitor every port link event in which the <i>Propagate connection error</i> checkbox is active. |
| External memory not in sync with NVM | The device monitors synchronization between the device configuration and the configuration stored on the ENVN. |
| External memory removed | Enable this function to monitor the presence of an external storage device. |
| Power supply | Enable this function to monitor the power supply. |

Table 27: Device Status events

■ Displaying the signal contact's status

The device gives you additional options for displaying the status of the signal contact:

- ▶ Display in the graphical user interface
- ▶ Query in the Command Line Interface

- Open the *Basic Settings > System* dialog.
The *Signal contact status* frame displays the signal contact status and informs you about alarms that have occurred. When an alarm currently exists, the frame is highlighted.

| | |
|---------------------------|--|
| show signal-contact 1 all | Displays signal contact settings for the specified signal contact. |
|---------------------------|--|

13.5 Port status indication

Perform the following steps:

- Open the *Basic Settings > System* dialog.

The dialog displays the device with the current configuration. Furthermore, the dialog indicates the status of the individual ports with a symbol.

The following symbols represent the status of the individual ports. In some situations, these symbols interfere with one another. If you position the mouse pointer over the port icon, a bubble help displays a detailed description of the port state.









| Criterion | Symbol |
|-----------------------|--|
| Bandwidth of the port |  10 Mbit/s Port activated, connection okay, full-duplex mode |
| |  100 Mbit/s Port activated, connection okay, full-duplex mode |
| |  1000 Mbit/s Port activated, connection okay, full-duplex mode |
| Operating state |  Half-duplex mode enabled See the <i>Basic Settings > Port</i> dialog, <i>Configuration</i> tab, <i>Automatic configuration</i> checkbox, <i>Manual configuration</i> field and <i>Manual cable crossing (Auto. conf. off)</i> field. |
| |  Autonegotiation enabled See the <i>Basic Settings > Port</i> dialog, <i>Configuration</i> tab, <i>Automatic configuration</i> checkbox. |
| |  The port is blocked by a redundancy function. |
| AdminLink |  The port is deactivated, connection okay |
| |  The port is deactivated, no connection set up See the <i>Basic Settings > Port</i> dialog, <i>Configuration</i> tab, <i>Port on</i> checkbox and <i>Link/Current settings</i> field. |

Table 28: Symbols identifying the status of the ports

13.6 Port event counter

The port statistics table enables experienced network administrators to identify possible detected problems in the network.

This table displays the contents of various event counters. The packet counters add up the events sent and the events received. In the *Basic Settings > Restart* dialog, you can reset the event counters.

| Counter | Indication of known possible weakness |
|--------------------|--|
| Received fragments | <ul style="list-style-type: none"> – Non-functioning controller of the connected device – Electromagnetic interference in the transmission medium |
| CRC Error | <ul style="list-style-type: none"> – Non-functioning controller of the connected device – Electromagnetic interference in the transmission medium – Inoperable component in the network |
| Collisions | <ul style="list-style-type: none"> – Non-functioning controller of the connected device – Network over extended/lines too long – Collision or a detected fault with a data packet |

Table 29: Examples indicating known weaknesses

Perform the following steps:

- To display the event counter, open the *Basic Settings > Port* dialog, *Statistics* tab.
- To reset the counters, in the *Basic Settings > Restart* dialog, click the *Clear port statistics* button.

13.6.1 Detecting non-matching duplex modes

Problems occur when 2 ports directly connected to each other have mismatching duplex modes. These problems are difficult to track down. The automatic detection and reporting of this situation has the benefit of recognizing mismatching duplex modes before problems occur.

This situation arises from an incorrect configuration, for example, if you deactivate the automatic configuration on the remote port.

A typical effect of this non-matching is that at a low data rate, the connection seems to be functioning, but at a higher bi-directional traffic level the local device records a lot of CRC errors, and the connection falls significantly below its nominal capacity.

The device allows you to detect this situation and report it to the network management station. In the process, the device evaluates the error counters of the port in the context of the port settings.

■ Possible causes of port error events

The following table lists the duplex operating modes for TX ports, with the possible fault events. The meanings of terms used in the table are as follows:

- ▶ Collisions
In half-duplex mode, collisions mean normal operation.
- ▶ Duplex problem
Mismatching duplex modes.
- ▶ EMI
Electromagnetic interference.
- ▶ Network extension
The network extension is too great, or too many cascading hubs.
- ▶ Collisions, Late Collisions
In full-duplex mode, no incrementation of the port counters for collisions or Late Collisions.
- ▶ CRC Error
The device evaluates these errors as non-matching duplex modes in the manual full duplex mode.

| No. | Automatic configuration | Current duplex mode | Detected error events (≥ 10 after link up) | Duplex modes | Possible causes |
|-----|-------------------------|---------------------|--|-------------------------|--|
| 1 | marked | Half duplex | None | OK | |
| 2 | marked | Half duplex | Collisions | OK | |
| 3 | marked | Half duplex | Late Collisions | Duplex problem detected | Duplex problem, EMI, network extension |
| 4 | marked | Half duplex | CRC Error | OK | EMI |
| 5 | marked | Full duplex | None | OK | |
| 6 | marked | Full duplex | Collisions | OK | EMI |
| 7 | marked | Full duplex | Late Collisions | OK | EMI |
| 8 | marked | Full duplex | CRC Error | OK | EMI |
| 9 | unmarked | Half duplex | None | OK | |
| 10 | unmarked | Half duplex | Collisions | OK | |
| 11 | unmarked | Half duplex | Late Collisions | Duplex problem detected | Duplex problem, EMI, network extension |
| 12 | unmarked | Half duplex | CRC Error | OK | EMI |
| 13 | unmarked | Full duplex | None | OK | |
| 14 | unmarked | Full duplex | Collisions | OK | EMI |
| 15 | unmarked | Full duplex | Late Collisions | OK | EMI |
| 16 | unmarked | Full duplex | CRC Error | Duplex problem detected | Duplex problem, EMI |

Table 30: Evaluation of non-matching of the duplex mode

13.7 Auto-Disable

The device can disable a port due to several configurable reasons. Each reason causes the port to “shut down”. In order to recover the port from the shut down state, you can manually clear the condition which caused the port to shut down or specify a timer to automatically re-enable the port.

If the configuration displays a port as enabled, but the device detects an error or change in the condition, the software shuts down that port. In other words, the device software disables the port because of a detected error or change in the condition.

When a port is auto-disabled, the device effectively shuts down the port and the port blocks traffic. The port LED blinks green 3 times per period and identifies the reason for the shutdown. In addition, the device creates a log file entry which lists the causes of the deactivation. When you re-enable the port after a timeout using the *Auto-Disable* function, the device generates a log entry.

The *Auto-Disable* function provides a recovery function which automatically enables an auto-disabled port after a user-defined time. When this function enables a port, the device sends an SNMP trap with the port number, but without a value for the *Reason* parameter.

The *Auto-Disable* function serves the following purposes:

- ▶ It assists the network administrator in port analysis.
- ▶ It reduces the possibility that this port causes the network to be instable.

The *Auto-Disable* function is available for the following functions:

- ▶ *Link flap* (*Port Monitor* function)
- ▶ *CRC/Fragments* (*Port Monitor* function)
- ▶ Duplex Mismatch detection (*Port Monitor* function)
- ▶ *Spanning Tree*
- ▶ *Port Security*
- ▶ *Overload detection* (*Port Monitor* function)
- ▶ *Link speed/Duplex mode detection* (*Port Monitor* function)

In the following example, you configure the device to disable a port due to detected violations to the thresholds specified the *Diagnostics > Ports > Port Monitor > CRC/Fragments* tab and then automatically re-enable the disabled port.

Perform the following steps:

- Open the *Diagnostics > Ports > Port Monitor* dialog, *CRC/Fragments* tab.
- Verify that the thresholds specified in the table concur to your preferences for port 1/1.
- Open the *Diagnostics > Ports > Port Monitor* dialog, *Global* tab.
- To enable the function, select the *On* radio button in the *Operation* frame.
- To allow the device to disable the port due to detected errors, mark the checkbox in the *CRC/Fragments on* column for port 1/1.

- In the **Action** column you can choose how the device reacts to detected errors. In this example, the device disables port 1/1 for threshold violations and then automatically re-enables the port.
 - ▶ To allow the device to disable and automatically re-enable the port, select the value `auto-disable` and configure the **Auto-Disable** function. The value `auto-disable` only works in conjunction with the **Diagnostics > Ports > Auto-Disable** function.
- The device can also disable a port without auto re-enabling.
 - ▶ To allow the device to disable the port only, select the value `disable port`. To manually re-enable a disabled port, highlight the port.
 - Click the  button and then the **Reset** item.
 - ▶ When you configure the **Auto-Disable** function, the value `disable port` also automatically re-enables the port.
- Open the **Diagnostics > Ports > Port Monitor** dialog, **Auto-disable** tab.
- To allow the device to auto re-enable the port after it was disabled due to detected threshold violations, mark the checkbox in the **CRC error** column.
- Open the **Diagnostics > Ports > Port Monitor** dialog, **Port** tab.
- Specify the delay time as 120 s in the **Reset timer [s]** column for the ports you want to enable.

Note: The **Reset** item allows you to enable the port before the time specified in the **Reset timer [s]** column counts down.

| | |
|---|--|
| <code>enable</code> | Change to the Privileged EXEC mode. |
| <code>configure</code> | Change to the Configuration mode. |
| <code>interface 1/1</code> | Change to the interface configuration mode of interface 1/1. |
| <code>port-monitor condition crc-fragments count 2000</code> | Specifying the CRC-Fragment counter to 2000 parts per million. |
| <code>port-monitor condition crc-fragments interval 15</code> | Sets the measure interval to 15 seconds for CRC-Fragment detection. |
| <code>auto-disable timer 120</code> | Specifies the waiting period of 120 seconds, after which the Auto-disable function re-enables the port. |
| <code>exit</code> | Change to the Configuration mode. |
| <code>auto-disable reason crc-error</code> | Activate the auto-disable CRC function. |
| <code>port-monitor condition crc-fragments mode</code> | Activate the CRC-Fragments condition to trigger an action. |
| <code>port-monitor operation</code> | Activate the Port Monitor function. |

When the device disables a port due to threshold violations the device allows you to use the following CLI commands to manually reset the disabled port.

Perform the following steps:

| | |
|---------------------------------|--|
| <code>enable</code> | Change to the Privileged EXEC mode. |
| <code>configure</code> | Change to the Configuration mode. |
| <code>interface 1/1</code> | Change to the interface configuration mode of interface 1/1. |
| <code>auto-disable reset</code> | Allows you to enable the port before the Timer counts down. |

13.8 Displaying the SFP status

The SFP status display allows you to look at the current SFP module connections and their properties. The properties include:

- ▶ module type
- ▶ serial number of media module
- ▶ temperature in ° C
- ▶ transmission power in mW
- ▶ receive power in mW

Perform the following steps:

-  Open the *Diagnostics* > *Ports* > *SFP* dialog.

13.9 Topology discovery

IEEE 802.1AB defines the Link Layer Discovery Protocol (LLDP). LLDP allows the user to automatically detect the LAN network topology.

Devices with LLDP active:

- ▶ broadcast their connection and management information to neighboring devices on the shared LAN. Evaluation of the devices occur when the receiving device has its LLDP function active.
- ▶ receive connection and management information from neighbor devices on the shared LAN, provided these adjacent devices also have LLDP active.
- ▶ build a management information database and object definitions for storing information about adjacent devices with LLDP active.

As the main element, the connection information contains an exact, unique identifier for the connection end point: MAC (Service Access Point). This is made up of a device identifier which is unique on the entire network and a unique port identifier for this device.

- ▶ Chassis identifier (its MAC address)
- ▶ Port identifier (its port-MAC address)
- ▶ Description of port
- ▶ System name
- ▶ System description
- ▶ Supported system capabilities
- ▶ System capabilities currently active
- ▶ Interface ID of the management address
- ▶ VLAN-ID of the port
- ▶ Auto-negotiation status on the port
- ▶ Medium, half/full duplex setting and port speed setting
- ▶ Information about the VLANs installed in the device (VLAN-ID and VLAN name, irrespective of whether the port is a VLAN participant).

A network management station can call up this information from devices with activated LLDP. This information enables the network management station to map the topology of the network.

Non-LLDP devices normally block the special Multicast LLDP IEEE MAC address used for information exchange. Non-LLDP devices therefore discard LLDP packets. When positioning a non-LLDP capable device between 2 LLDP capable devices, the non-LLDP capable device prohibits information exchanges between the 2 LLDP capable devices.

The Management Information Base (MIB) for a device with LLDP capability holds the LLDP information in the lldp MIB and in the private HM2-LLDP-EXT-HM-MIB and HM2-LLDP-MIB.

13.9.1 Displaying the Topology discovery results

To show the topology of the network:

-  Open the *Diagnostics > LLDP > LLDP Topology Discovery* dialog, *LLDP* tab.

If you use a port to connect several devices, for example via a hub, the table contains a line for each connected device.

Activating Display FDB Entries at the bottom of the table allows you to display devices without active LLDP support in the table. In this case, the device also includes information from its FDB (forwarding database).

If you connect the port to devices with the topology discovery function active, then the devices exchange LLDP Data Units (LLDPDU) and the topology table displays these neighboring devices.

When a port connects devices without an active topology discovery exclusively, the table contains a line for this port to represent the connected devices. This line contains the number of connected devices.

The FDB address table contains MAC addresses of devices that the topology table hides for the sake of clarity.

13.9.2 LLDP-Med

LLDP for Media Endpoint Devices (LLDP-MED) is an extension to LLDP that operates between endpoint devices. Endpoints include devices such as IP phones, or other Voice over IP (VoIP) devices or servers and network devices such as switches. It specifically provides support for VoIP applications. LLDP-MED provides this support using an additional set of common type-length-value (TLV) advertisement messages, for capabilities discovery, network policy, Power over Ethernet, inventory management and location information.

The device supports the following TLV messages:

- ▶ capabilities TLV
Allows LLDP-MED endpoints to determine the capabilities that the connected device supports and what capabilities the device has enabled.
- ▶ Network policy TLV
Allows both network connectivity devices and endpoints to advertise VLAN configurations and associated attributes for the specific application on that port. For example, the device notifies a phone of the VLAN number. The phone connects to a switch, obtain its VLAN number, and then starts communicating with the call control.

LLDP-MED provides the following functions:

- ▶ Network policy discovery, including VLAN ID, 802.1p priority and Diffserv code point (DSCP)
- ▶ Device location and topology discovery based on LAN-level MAC/port information
- ▶ Endpoint move detection notification, from network connectivity device to the associated VoIP management application
- ▶ Extended device identification for inventory management
- ▶ Identification of endpoint network connectivity capabilities, for example, multi-port IP Phone with embedded switch or bridge capability
- ▶ Application level interactions with the LLDP protocol elements to provide timely startup of LLDP to support rapid availability of an Emergency Call Service
- ▶ Applicability of LLDP-MED to Wireless LAN environments, support for Voice over Wireless LAN

13.10 Detecting loops

Loops in the network cause connection interruptions or data losses. This also applies to temporary loops. The automatic detection and reporting of this situation allows you to detect it faster and diagnose it more easily.

An incorrect configuration causes loops, for example, if you deactivate Spanning Tree.

The device allows you to detect the effects typically caused by loops and report this situation automatically to the network management station. You have the option here to specify the magnitude of the loop effects that trigger the device to send a report.

BPDUs sent from the designated port and received on either a different port of the same device or the same port within a short time, is a typical effect of a loop.

- Open the *Switching > L2-Redundancy > Spanning Tree > Port* dialog, *CIST* tab.
- Check the value in the fields *Port state* and *Port role*. If the *Port state* field displays the value `discarding` and the *Port role* field displays the value `backup`, the port is in a loop status.
or
- Open the *Switching > L2-Redundancy > Spanning Tree > Port* dialog, *Guards* tab.
- Check the value in the *Loop state* column. If the field displays the value `true`, the port is in a loop status.

13.11 Reports

The following lists reports and buttons available for diagnostics:

- ▶ System Log file
The log file is an HTML file in which the device writes important device-internal events.
- ▶ Audit Trail
Logs successful CLI commands and user comments. The file also includes SNMP logging.
- ▶ Persistent Logging
The device saves log entries in a file in the external memory, when present. These files are available after power down. The maximum size, maximum number of retainable files and the severity of logged events are configurable. After obtaining the user-defined maximum size or maximum number of retainable files, the device archives the entries and starts a new file. The device deletes the oldest file and renames the other files to maintain the configured number of files. To review these files use the CLI or copy them to an external server for future reference.
- ▶ Download Support Information
This button allows you to download system information as files in a ZIP archive.

In service situations, these reports provide the technician with the necessary information.

13.11.1 Global settings

Using this dialog you enable or disable where the device sends reports, for example, to a Console, a Syslog Server, or a CLI connection. You also set at which severity level the device writes events into the reports.

Perform the following steps:

- Open the *Diagnostics > Report > Report Global* dialog.
- To send a report to the console, specify the desired level in the *Console logging* frame, *Severity* field.
- To enable the function, select the *On* radio button in the *Console logging* frame.
- To save the changes temporarily, click the button.

The device buffers logged events in 2 separate storage areas so that the device keeps log entries for urgent events. Specify the minimum severity for events that the device logs to the buffered storage area with a higher priority.

Perform the following steps:

- To send events to the buffer, specify the desired level in the *Buffered logging* frame, *Severity* field.
- To save the changes temporarily, click the button.

When you activate the logging of SNMP requests, the device logs the requests as events in the Syslog. The *Log SNMP get request* function logs user requests for device configuration information. The *Log SNMP set request* function logs device configuration events. Specify the minimum level for events that the device logs in the Syslog.

Perform the following steps:

- Enable the *Log SNMP get request* function for the device in order to send SNMP Read requests as events to the Syslog server.
To enable the function, select the **On** radio button in the *SNMP logging* frame.
- Enable the *Log SNMP set request* function for the device in order to send SNMP Write requests as events to the Syslog server.
To enable the function, select the **On** radio button in the *SNMP logging* frame.
- Choose the desired severity level for the get and set requests.
- To save the changes temporarily, click the button.

When active, the device logs configuration changes made using the CLI commands, to the audit trail. This feature is based on the IEEE 1686 standard for Substation Intelligent Electronic Devices.

Perform the following steps:

- Open the *Diagnostics > Report > Report Global* dialog.
- To enable the function, select the **On** radio button in the *CLI logging* frame.
- To save the changes temporarily, click the button.

The device allows you to save the following system information data in one ZIP file on your PC:

- ▶ audittrail.html
- ▶ CLICommands.txt
- ▶ defaultconfig.xml
- ▶ script
- ▶ runningconfig.xml
- ▶ supportinfo.html
- ▶ systeminfo.html
- ▶ systemlog.html

The device creates the file name of the ZIP archive automatically in the format `<IP_address>_<system_name>.zip`.

Perform the following steps:



- Click the  button and then the *Download support information* item.
- Select the directory in which you want to save the support information.
- To save the changes temporarily, click the button.

13.11.2 Syslog

The device enables you to send messages about important device internal events to one or more Syslog servers (up to 8). Additionally, you also include SNMP requests to the device as events in the Syslog.

Note: To display the logged events, open the *Diagnostics > Report > Audit Trail* dialog or the *Diagnostics > Report > System Log* dialog.

Perform the following steps:

- Open the *Diagnostics > Syslog* dialog.
- To add a table entry, click the  button.
- In the *IP address* column, enter the IP address of the Syslog server.
- In the *Destination UDP port* column, specify the UDP port on which the Syslog server expects the log entries.
- In the *Min. severity* column, specify the minimum seriousness level an event must attain for the device to send a log entry to this Syslog server.
- Mark the checkbox in the *Active* column.
- To enable the function, select the *On* radio button in the *Operation* frame.
- To save the changes temporarily, click the  button.

In the *SNMP logging* frame, configure the following settings for read and write SNMP requests:

Perform the following steps:

- Open the *Diagnostics > Report > Report Global* dialog.
- Enable the *Log SNMP get request* function for the device in order to send SNMP Read requests as events to the Syslog server.
To enable the function, select the *On* radio button in the *SNMP logging* frame.
- Enable the *Log SNMP set request* function for the device in order to send SNMP Write requests as events to the Syslog server.
To enable the function, select the *On* radio button in the *SNMP logging* frame.
- Choose the desired severity level for the get and set requests.
- To save the changes temporarily, click the  button.

```
enable
configure
logging host add 1 addr 10.0.1.159
severity 3

logging syslog operation
exit
show logging host
```

Change to the Privileged EXEC mode.
Change to the Configuration mode.
Adds a new recipient in the Syslog servers list. The value 3 specifies the severity level of the event that the device logs. The value 3 means **Error**.
Enable the *Syslog* function.
Change to the Privileged EXEC mode.
Display the Syslog host settings.

| No. | Server IP | Port | Max. Severity | Type | Status |
|-----|------------|------|---------------|-----------|--------|
| 1 | 10.0.1.159 | 514 | error | systemlog | active |

```
configure
logging snmp-requests get operation
logging snmp-requests get severity 5

logging snmp-requests set operation
```

Change to the Configuration mode.
Logs SNMP GET requests.
The value 5 specifies the severity level of the event that the device logs in case of SNMP GET requests. The value 5 means **Notice**.
Logs SNMP SET requests.

```
logging snmp-requests set severity 5
exit
show logging snmp

Log SNMP GET requests      : enabled
Log SNMP GET severity      : notice
Log SNMP SET requests      : enabled
Log SNMP SET severity      : notice
```

The value 5 specifies the severity level of the event that the device logs in case of SNMP SET requests. The value 5 means Notice.

Change to the Privileged EXEC mode.

Display the SNMP logging settings.

13.11.3 System Log

The device allows you to call up a log file of the system events. The table in the *Diagnostics > Report > System Log* dialog lists the logged events.

Perform the following steps:

- To update the content of the log, click “Reload”.
- To search the content of the log for a key word, click “Search”.
- To archive the content of the log as an html file, click “Save”.

Note: You have the option to also send the logged events to one or more Syslog servers.

13.11.4 Audit Trail

The *Diagnostics > Report > Audit Trail* dialog contains system information and changes to the device configuration performed through CLI and SNMP. In the case of device configuration changes, the dialog displays Who changed What and When. To log changes to the device configuration, use in the *Diagnostics > Report > Audit Trail* dialog the functions *Log SNMP get request* and *Log SNMP set request*.

The *Diagnostics > Syslog* dialog allows you to configure up to 8 Syslog servers to which the device sends Audit Trails.

The following list contains log events:

- ▶ changes to configuration parameters
- ▶ CLI commands (except show commands)
- ▶ CLI command `logging audit-trail <string>` which logs the comment
- ▶ Automatic changes to the System Time
- ▶ watchdog events
- ▶ locking a user after several unsuccessful login attempts
- ▶ User login, either locally or remote, using CLI
- ▶ Manual, user-initiated, logout
- ▶ Timed logout after a user-defined period of CLI inactivity

- ▶ file transfer operation including a Firmware Update
- ▶ Configuration changes using HiDiscovery
- ▶ Automatic configuration or firmware updates using the external memory
- ▶ Blocked management access due to invalid login
- ▶ rebooting
- ▶ opening and closing SNMP over HTTPS tunnels
- ▶ Detected power failures

13.12 Network analysis with TCPdump

Tcpdump is a packet-sniffing UNIX utility used by network administrators to sniff and analyze traffic on a network. A couple of reasons for sniffing traffic on a network is to verify connectivity between hosts, or to analyze the traffic traversing the network.

TCPDump on the device provides the possibility to decode or capture packets received and transmitted by the Management CPU. This function is available using the `debug` CLI command. Refer to the “Command Line Interface” reference manual for further information about the TCPDump function.

13.13 Monitoring the data traffic

The device allows you to forward data packets that pass through the device to a destination port. There you can monitor and evaluate the data packets.

The device provides you with the following options:

- ▶ [Port Mirroring](#)

13.13.1 Port Mirroring

The *Port Mirroring* function allows you to copy data packets from physical source ports to a physical destination port.

You monitor the data traffic on the source ports in the sending and receiving directions with a management tool connected on the destination port, for example an RMON probe. The function has no affect on the data traffic running on the source ports.

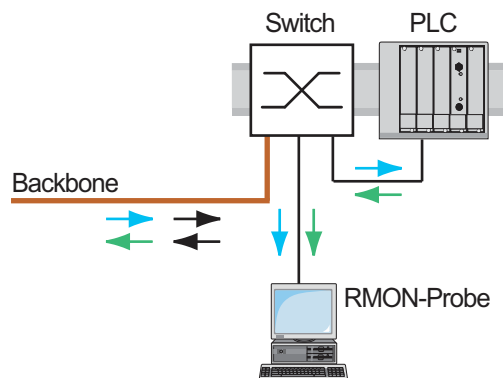

Figure 53: Example

On the destination port, the device exclusively sends the data packets copied from the source ports.

Before you switch on the *Port Mirroring* function, mark the checkbox *Allow management* to access the management functions via the destination port. The device allows access to the management functions via the destination port without interrupting the active *Port Mirroring* session.

Note: The device duplicates multicasts, broadcasts and unknown unicasts on the destination port. The VLAN settings on the destination port remain unchanged. Prerequisite for management access at the destination port is that the destination port is a member of the management VLAN.

Restrictions apply to ports on which the following redundancy protocols are active:

- ▶ Fast MRP
No port mirroring of sent MRP test packets.
- ▶ HSR, PRP
To monitor the data stream on HSR/PRP ports, specify the source port 1/1. On the source port 1/1, the *Port Mirroring* function records:
 - Data packets coming into the HSR/PRP network from the outside through the device
 - Data packets after duplicate recognition that leave the HSR/PRP network through the device
 - No Link Local packets that protocols like LLDP work with

■ Enabling the Port Mirroring function

Perform the following steps:

- Open the *Diagnostics > Ports > Port Mirroring* dialog.
- Specify the source ports.
Mark the checkbox in the *Enabled* column for the relevant ports.
- Specify the destination port.
In the *Destination port* frame, select the desired port in the *Primary port* drop-down list. The drop-down list only displays available ports. Ports that are already specified as source ports are unavailable.
- In order to access the management functions of the device via the destination port:
In the *Destination port* frame, mark the *Allow management* checkbox.
- To save the changes temporarily, click the button.

To deactivate the *Port Mirroring* function and restore the default settings, click the  button and then the *Reset config* item.

13.14 Self-test

The device checks its assets during the boot process and occasionally thereafter. The device checks system task availability or termination and the available amount of memory. Furthermore, the device checks for application functionality and if there is any hardware degradation in the chip set.

When the device detects a loss in integrity, the device responds to the degradation with a user-defined action. The following categories are available for configuration.

- ▶ `task`
Action to be taken when a task is unsuccessful.
- ▶ `resource`
Action to be taken due to the lack of resources.
- ▶ `software`
Action taken for loss of software integrity; for example, code segment checksum or access violations.
- ▶ `hardware`
Action taken due to hardware degradation

Configure each category to produce an action when the device detects a loss in integrity. The following actions are available for configuration.

- ▶ `log only`
This action writes a message to the logging file.
- ▶ `send trap`
Sends an SNMP trap to the trap destination.
- ▶ `reboot`
An error in the category, when activated, will cause the device to reboot

Perform the following steps:

- Open the *Diagnostics > System > Selftest* dialog.
- In the *Action* column, specify the action to perform for a cause.
- To save the changes temporarily, click the button.

| | |
|------------------------------------|---|
| enable | Change to the Privileged EXEC mode. |
| configure | Change to the Configuration mode. |
| selftest action task log-only | To send a message to the event log when a task is unsuccessful. |
| selftest action resource send-trap | Sending an SNMP trap if there are insufficient resources. |
| selftest action software send-trap | Sending an SNMP trap if the software integrity has been lost. |
| selftest action hardware reboot | To reboot the device when hardware degradation occurs. |

Disabling these functions lets you decrease the time required to restart the device after a cold start. You find these options in the *Diagnostics > System > Selftest* dialog, *Configuration* frame.

- ▶ *RAM test*
Activates/deactivates the RAM test function during a cold start.
- ▶ *SysMon1 is available*
Activates/deactivates the System Monitor function during a cold start.
- ▶ *Load default config on error*
Activates/deactivates the loading of the default device configuration if no readable configuration is available during a restart.

Note: The following settings block your access to the device permanently if the device does not detect any readable configuration profile when it is restarting. This is the case, for example, if the password of the configuration profile that you are loading differs from the password set in the device.

- ▶ The *SysMon1 is available* checkbox is unmarked.
- ▶ The *Load default config on error* checkbox is unmarked.

To have the device unlocked again, contact your sales partner.

```
selftest ramtest
```

Enable RAM selftest on cold start.

```
no selftest ramtest
```

Disable the "ramtest" function.

```
selftest system-monitor
```

Enable the "SysMon1" function.

```
no selftest system-monitor
```

Disable the "SysMon1" function.

```
show selftest action
```

Show status of the actions to be taken in the event of device degradation.

```
show selftest settings
```

Display the settings for "ramtest" and "SysMon" settings in event of a cold start.

14 Advanced functions of the device

14.1 Using the device as a DHCP server

A DHCP server ("Dynamic Host Configuration Protocol") assigns IP addresses, Gateways, and other networking definitions such as DNS and NTP parameters to clients.

The DHCP operations fall into 4 basic phases: IP discovery, IP lease offer, IP request, and IP lease acknowledgment. Use the acronym DORA which stands for Discovery, Offer, Request, and Acknowledgement to help remember the phases. The server receives client data on UDP port 67 and sends data to the client on UDP port 68.

The DHCP server provides an IP address pool or "pool", from which it allocates IP addresses to clients. The pool consists of a list of entries. An entry defines either a specific IP address or an IP address range.

The device allows you to activate the DHCP server globally and per interface.

14.1.1 IP Addresses assigned per port or per VLAN

The DHCP server assigns a static IP address or dynamic range of IP addresses to a client connected to a port or a VLAN. The device allows you to create entries for either a port or a VLAN. When creating an entry to assigning IP addresses to a VLAN the port entry grays out. When creating an entry to assigning IP addresses to a port the VLAN entry grays out.



Static allocation means that the DHCP server assigns the same IP address to a specific client. The DHCP server identifies the client using a unique hardware ID. A static address entry contains 1 IP address, and applies it to a port or VLAN on which the server receives a request from a specific client. For static allocation, create a pool entry for the ports or one specific port, enter the IP address, and leave the *Last IP address* column empty. Specify a hardware ID with which the DHCP server uniquely identifies the client. This ID is either a MAC address, a client ID, a remote ID, or a circuit ID. If a client contacts the server with the configured hardware ID, the DHCP server allocates the static IP address.

The device also allows you to assign a dynamic IP address range to ports or VLANs from which the DHCP server allocates a free IP address from a pool. To add a dynamic pool entry for the ports or VLANs, specify the first and last IP addresses for the IP address range, leaving the *MAC address*, Client ID, *Remote ID*, and *Circuit ID* columns empty. Creating multiple pool entries allows you to have IP address ranges that contain gaps.

14.1.2 DHCP server static IP address example

In this example, configure the device to allocate a static IP address to a port. The device recognizes clients with unique hardware identification. The Hardware ID in this case is the client MAC address 00:24:E8:D6:50:51.

Perform the following steps:

- Open the *Advanced > DHCP Server > Pool* dialog.
- To add a table entry, click the  button.
- In the *IP address* column, specify the value 192.168.23.42.
- In the *Port* column, specify the value 1/1.
- In the *MAC address* column, specify the value 00:24:E8:D6:50:51.
- To assign the IP address to the client infinitely, in the *Lease time [s]* column, specify the value 4294967295.
- Mark the checkbox in the *Active* column.
- Open the *Advanced > DHCP Server > Global* dialog.
- For port 1/1, mark the checkbox in the *DHCP server active* column.
- To enable the function, select the *On* radio button in the *Operation* frame.
- To save the changes temporarily, click the  button.

| | |
|---|--|
| enable | Change to the Privileged EXEC mode. |
| configure | Change to the Configuration mode. |
| dhcp-server pool add 1 static 192.168.23.42 | Creating an entry with index 1 and adding the IP address 192.168.23.42 to the static pool. |
| dhcp-server pool modify 1 mode interface 1/1 | Assign the static address in index 1 to interface 1/1. |
| dhcp-server pool modify 1 mode mac 00:24:E8:D6:50:51 | Assign the IP address in index 1 to the device with the MAC address 00:24:E8:D6:50:51. |
| dhcp-server pool mode 1 | Enable the index 1 pool entry. |
| dhcp-server pool modify 1 leasetime infinite | To allocate the IP address to the client infinitely, modify the entry with index 1. |
| dhcp-server operation | Enable the DHCP server globally. |
| interface 1/1 | Change to the interface configuration mode of interface 1/1. |
| dhcp-server operation | Activate the <i>DHCP Server</i> server function on this port. |

14.1.3 DHCP server dynamic IP address range example

The device allows you to create dynamic IP address ranges. Leave the *MAC address*, *Client ID*, *Remote ID* and *Circuit ID* fields empty. To create dynamic IP address ranges with gaps between the ranges add several entries to the table.

Perform the following steps:

- Open the *Advanced > DHCP Server > Pool* dialog.
- To add a table entry, click the  button.
- In the *IP address* column, specify the value 192.168.23.92. This is the first IP address of the range.

- In the *Last IP address* column, specify the value 192.168.23.142.
This is the last IP address of the range.
- In the *Lease time [s]* column, the default setting is 60 days.
- In the *Port* column, specify the value 1/2.
- Mark the checkbox in the *Active* column.
- Open the *Advanced > DHCP Server > Global* dialog.
- For port 1/2, mark the checkbox in the *DHCP server active* column.
- To enable the function, select the *On* radio button in the *Operation* frame.
- To save the changes temporarily, click the button.

enable

configure

```
dhcp-server pool add 2 dynamic  
192.198.23.92 192.168.23.142
```

```
dhcp-server pool modify 2 leasetime  
{seconds | infinite}
```

```
dhcp-server pool add 3 dynamic  
192.198.23.172 192.168.23.180
```

```
dhcp-server pool modify 3 leasetime  
{seconds | infinite}
```

```
dhcp-server pool mode 2
```

```
dhcp-server pool mode 3
```

```
dhcp-server operation
```

```
interface 2/1
```

```
dhcp-server operation
```

Change to the Privileged EXEC mode.

Change to the Configuration mode.

Add a dynamic pool with an IP range from 192.168.23.92 to 192.168.23.142.

Entering the Lease Time in seconds or infinite.

Add a dynamic pool with an IP range from 192.168.23.172 to 192.168.23.180.

Entering the Lease Time in seconds or infinite.

Enable the index 2 pool entry.

Enable the index 3 pool entry.

Enable the DHCP server globally.

Change to the interface configuration mode of interface 2/1.

Activate the *DHCP Server* server function on this port.

14.2 MRP-IEEE

The IEEE 802.1ak amendment to the IEEE 802.1Q standard introduced the Multiple Registration Protocol (MRP) to replace the Generic Attribute Registration Protocol (*GARP*). The IEEE also modified and replaced the *GARP* applications, *GARP* Multicast Registration Protocol (*GMRP*) and *GARP* VLAN Registration Protocol (*GVRP*), with the Multiple MAC Registration Protocol (*MMRP*) and the Multiple VLAN Registration Protocol (*MVRP*).

To confine traffic to the required areas of a network, the MRP applications distribute attribute values to MRP enabled devices across a LAN. The MRP applications register and de-register Multicast group memberships and VLAN identifiers.

Note: The Multiple Registration Protocol (MRP) requires a loop free network. To help prevent loops in your network, use a network protocol such as the Media Redundancy Protocol, Spanning Tree Protocol, or Rapid Spanning Tree Protocol with MRP.

14.2.1 MRP operation

Each participant contains an applicant component and an MRP Attribute Declaration (MAD) component. The applicant component is responsible for forming the attribute values and their registration and de-registration. The MAD component generates MRP messages for transmission and processes messages received from other participants. The MAD component encodes and transmits the attributes to other participants in MRP Data Units (MRPDU). In the switch, an MRP Attribute Propagation (MAP) component distributes the attributes to participating ports.

A participant exists for each MRP application and each LAN port. For example, a participant application exists on an end device and another application exists on a switch port. The Applicant state machine records the attribute and port for each MRP participant declaration on an end device or switch. Applicant state machine variable changes trigger the transmission of MRPDUs to communicate the declaration or withdrawal.

To establish an *MMRP* instance, an end device first sends a Join empty (JoinMt) message with the appropriate attributes. The switch then floods the JoinMt to the participating ports and to the neighboring switches. The neighboring switches flood the message to their participating port, and so on, establishing a path for the group traffic.

14.2.2 MRP timers

The default timer settings help prevent unnecessary attribute declarations and withdraws. The timer settings allow the participants to receive and process MRP messages before the Leave or LeaveAll timers expire.

Maintain the following relationships when you reconfigure the timers:

- ▶ To allow for re-registration after a Leave or LeaveAll event, even if there is a lost message, set the value of the LeaveTime as follows: $\geq (2x \text{JoinTime}) + 60$ in 1/100 s
- ▶ To minimize the volume of rejoining traffic generated following a LeaveAll, specify the value for the LeaveAll timer larger than the LeaveTime.

The following list contains various MRP events that the device transmits:

- ▶ Join - Controls the interval for the next Join message transmission
- ▶ Leave - Controls the length of time that a switch waits in the Leave state before changing to the withdraw state
- ▶ LeaveAll - Controls the frequency with which the switch generates LeaveAll messages

The Periodic timer, when expired, initiates a Join request MRP message that the switch sends to participants on the LAN. The switches use this message to prevent unnecessary withdraws.

14.2.3 MMRP

When a device receives Broadcast, Multicast or unknown traffic on a port, the device floods the traffic to the other ports. This process causes unnecessary use of bandwidth on the LAN.

The Multiple MAC Registration Protocol (*MMRP*) allows you to control the traffic flooding by distributing an attribute declaration to participants on a LAN. The attribute values that the MAD component encodes and transmits on the LAN in MRP messages are Group service requirement information and 48-bit MAC addresses.

The switch stores the attributes in a filtering database as MAC address registration entries. The forwarding process uses the filtering database entries solely to transmit data through those ports necessary to reach Group member LANs.

Switches facilitate the group distribution mechanisms based on the Open Host Group concept, receiving packets on the active ports and forward exclusively on ports with group members. This way, any *MMRP* participants requiring packets transmitted to a particular group or groups, requests membership in the group. MAC service users send packets to a particular group from anywhere on the LAN. A group receives these packets on the LANs attached to registered *MMRP* participants. *MMRP* and the MAC Address Registration Entries thus restrict the packets to required segments of a loop-free LAN.

In order to maintain the registration and deregistration state and to receive traffic, a port declares interest periodically. Every device on a LAN with the *MMRP* function enabled maintains a filtering database and forwards traffic having the group MAC addresses to listed participants.

■ MMRP example

In this example, Host A intends to listen to traffic destined to group G1. Switch A processes the *MMRP* Join request received from host A and sends the request to both of the neighboring switches. The devices on the LAN now recognize that there is a host interested in receiving traffic destined for group G1. When Host B starts transmitting data destined for group G1, the data flows on the path of registrations and Host A receives it.

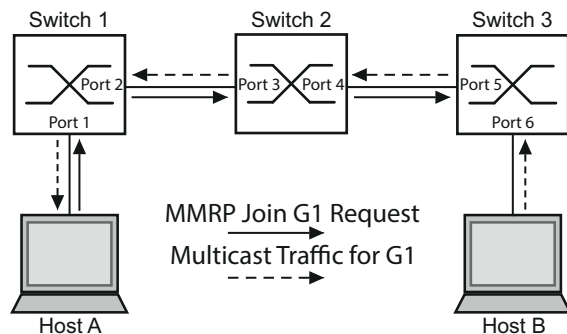

Figure 54: *MMRP* Network for MAC address Registration

To enable the *MMRP* function on the switches, proceed as follows.

Perform the following steps:

- Open the *Switching* > *MRP-IEEE* > *MMRP* dialog, *Configuration* tab.
- To activate port 1 and port 2 as *MMRP* participants, mark the checkbox in the *MMRP* column for port 1 and port 2 on switch 1.
- To activate port 3 and port 4 as *MMRP* participants, mark the checkbox in the *MMRP* column for port 3 and port 4 on switch 2.
- To activate port 5 and port 6 as *MMRP* participants, mark the checkbox in the *MMRP* column for port 5 and port 6 on switch 3.
- To send periodic events allowing the device to maintain the registration of the MAC address group, enable the *Periodic state machine*. Select the *On* radio button in the *Configuration* frame.
- To save the changes temporarily, click the button.

To enable the *MMRP* ports on switch 1, use the following CLI commands. Substituting the appropriate interfaces in the CLI commands, enable the *MMRP* functions and ports on switches 2 and 3.

```
enable
configure
interface 1/1
mrp-ieee mmrp operation
interface 1/2
mrp-ieee mmrp operation
exit
mrp-ieee mrp periodic-state-machine
mrp-ieee mmrp operation
```

Change to the Privileged EXEC mode.

Change to the Configuration mode.

Change to the interface configuration mode of interface 1/1.

Enabling the *MMRP* function on the port.

Change to the interface configuration mode of interface 1/2.

Enabling the *MMRP* function on the port.

Change to the Configuration mode.

Enabling the *Periodic state machine* function globally.

Enabling the *MMRP* function globally.

14.2.4 MVRP

The Multiple VLAN Registration Protocol (*MVRP*) is an MRP application that provides dynamic VLAN registration and withdraw services on a LAN.

The *MVRP* function provides a maintenance mechanism for the Dynamic VLAN Registration Entries, and for transmitting the information to other devices. This information allows *MVRP*-aware devices to establish and update their VLAN membership information. When members are present on a VLAN, the information indicates through which ports the switch forwards traffic to reach those members.

The main purpose of the *MVRP* function is to allow switches to discover some of the VLAN information that you otherwise manually set up. Discovering this information allows switches to overcome the limitations of bandwidth consumption and convergence time in large VLAN networks.

■ MVRP example

Set up a network comprised of MVRP aware switches (1 - 4) connected in a ring topology with end device groups, A1, A2, B1, and B2 in 2 different VLANs, A and B. With STP enabled on the switches, the ports connecting switch 1 to switch 4 are in the discarding state, preventing a loop condition.

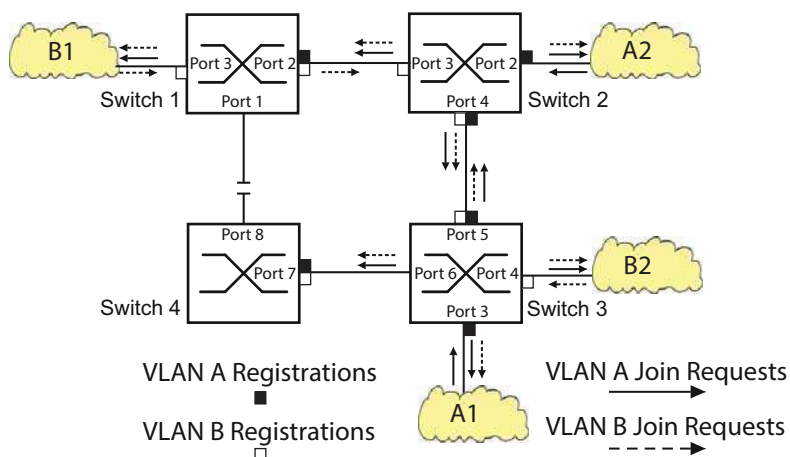

Figure 55: *MVRP* Example Network for VLAN Registration

In the MVRP example network, the LANs first send a Join request to the switches. The switch enters the VLAN registration in the forwarding database for the port receiving the frames.

The switch then propagates the request to the other ports, and sends the request to the neighboring LANs and switches. This process continues until the switches have registered the VLANs in the forwarding database of the receive port.

To enable MVRP on the switches, use the following steps.

- Open the *Switching > MRP-IEEE > MVRP* dialog, *Configuration* tab.
- To activate the ports 1 through 3 as *MVRP* participants, mark the checkbox in the *MVRP* column for the ports 1 through 3 on switch 1.
- To activate the ports 2 through 4 as *MVRP* participants, mark the checkbox in the *MVRP* column for the ports 2 through 4 on switch 2.
- To activate the ports 3 through 6 as *MVRP* participants, mark the checkbox in the *MVRP* column for the ports 3 through 6 on switch 3.
- To activate port 7 and port 8 as *MVRP* participants, mark the checkbox in the *MVRP* column for port 7 and port 8 on switch 4.
- To maintain the registration of the VLANs, enable the *Periodic state machine*. Select the *On* radio button in the *Configuration* frame.

- To enable the function, select the *On* radio button in the *Operation* frame.
- To save the changes temporarily, click the button.

To enable the *MVRP* ports on switch 1, use the following CLI commands. Substituting the appropriate interfaces in the CLI commands, enable the *MVRP* functions and ports on switches 2, 3 and 4.

| | |
|---|--|
| <pre>enable configure interface 1/1 mrp-ieee mvrp operation interface 1/2 mrp-ieee mvrp operation exit mrp-ieee mvrp periodic-state-machine mrp-ieee mvrp operation</pre> | <p>Change to the Privileged EXEC mode.</p> <p>Change to the Configuration mode.</p> <p>Change to the interface configuration mode of interface 1/1.</p> <p>Enabling the <i>MVRP</i> function on the port.</p> <p>Change to the interface configuration mode of interface 1/2.</p> <p>Enabling the <i>MVRP</i> function on the port.</p> <p>Change to the Configuration mode.</p> <p>Enabling the <i>Periodic state machine</i> function globally.</p> <p>Enabling the <i>MVRP</i> function globally.</p> |
|---|--|

14.3 CLI client

The device supports an CLI client that directly opens a connection to the SSH server using the TCP Port specified in the *Device Security > Management Access > Server* dialog, *SSH* tab. The CLI client allows you to configure the device using CLI commands.

The prerequisite to using the CLI client is that you enable the function in the *Device Security > Management Access > Server* dialog, *SSH* tab.

For detailed information on CLI commands, review the “Command Line Interface” reference manual.

15 Industry Protocols

For a long time, automation communication and office communication were on different paths. The requirements and the communication properties were too different.

Office communication moves large quantities of data with low demands with respect to the transfer time. Automation communication moves small quantities of data with high demands with respect to the transfer time and availability.

While the transmission devices in the office are usually kept in temperature-controlled, relatively clean rooms, the transmission devices used in automation are exposed to wider temperature ranges. Dirty, dusty and damp ambient conditions make additional demands on the quality of the transmission devices.

With the continued development of communication technology, the demands and the communication properties have moved closer together. The high bandwidths now available in Ethernet technology and the protocols they support enable large quantities to be transferred and exact transfer times to be specified.

With the creation of the first optical LAN to be active worldwide, at the University of Stuttgart in 1984, Hirschmann laid the foundation for industry-compatible office communication devices. Thanks to Hirschmann's initiative with the world's first rail hub in the 1990s, Ethernet transmission devices such as switches, routers and firewalls are now available for the toughest automation conditions.

The desire for uniform, continuous communication structures encouraged many manufacturers of automation devices to come together and use standards to aid the progress of communication technology in the automation sector. This is why we now have protocols that enable us to communicate via Ethernet from the office right down to the field level.

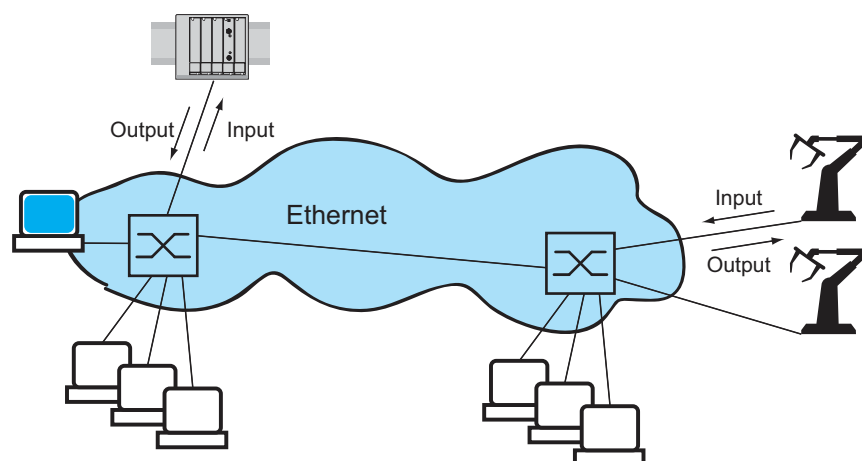

Figure 56: Example of communication.

15.1 IEC 61850/MMS

IEC 61850/MMS is an industrial communication protocol standardized by the International Electrotechnical Commission (IEC). The protocol is to be found in substation automation, for example in the control technology of energy suppliers.

This protocol, which works in a packet-oriented way, is based on the TCP/IP transport protocol and uses the Manufacturing Messaging Specification (MMS) for the client-server communication. The protocol is object-oriented and defines a standardized configuration language that comprises, among other things, functions for SCADA, Intelligent Electronic Devices (IED) and for the network control technology.

Part 6 of the IEC 61850 standard defines the configuration language SCL (Substation Configuration Language). SCL describes the properties of the device and the system structure in an automatically processable form. The properties of the device described with SCL are stored in the ICD file on the device.

15.1.1 Switch model for IEC 61850

The Technical Report, IEC 61850 90-4, specifies a bridge model. The bridge model represents the functions of a switch as objects of an Intelligent Electronic Device (IED). An MMS client (for example the control room software) uses these objects to monitor and configure the device.

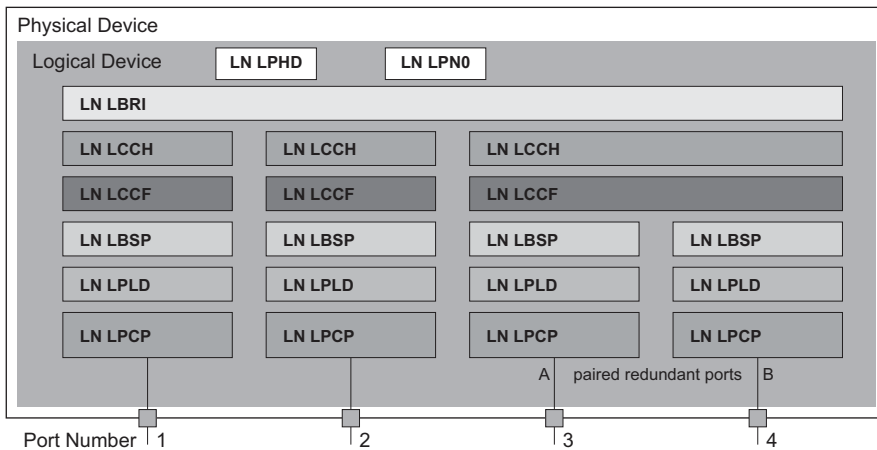

Figure 57: Bridge model based on Technical Report IEC 61850 90-4

| Class | Description |
|---------|--|
| LN LLN0 | Zero logical node of the Bridge IED: Defines the logical properties of the device. |
| LN LPHD | Physical Device logical node of the Bridge IED: Defines the physical properties of the device. |
| LN LBRI | Bridge logical node: Represents general settings of the bridge functions of the device. |
| LN LCCH | Communication Channel logical node: Defines the logical Communication Channel that consists of one or more physical device ports. |

Table 31: Classes of the bridge model based on TR IEC61850 90-4

| Class | Description |
|---------|---|
| LN LCCF | Channel Communication Filtering logical node: Defines the VLAN and Multicast settings for the higher-level Communication Channel. |
| LN LBSP | Port Spanning Tree Protocol logical node: Defines the Spanning Tree statuses and settings for the respective physical device port. |
| LN LPLD | Port Layer Discovery logical node: Defines the LLDP statuses and settings for the respective physical device port. |
| LN LPCP | Physical Communication Port logical node: Represents the respective physical device port. |

Table 31: Classes of the bridge model based on TR IEC61850 90-4 (cont.)

15.1.2 Integration into a Control System

■ Preparation of the device.

- Check that the device has an IP address assigned.
- Open the *Advanced > Industrial Protocols > IEC61850-MMS* dialog.
- To start the MMS server, select in the *Operation* frame the *On* radio button, and click button.

Afterwards, an MMS client is able to connect to the device and to read and monitor the objects defined in the bridge model.

NOTICE

RISK OF UNAUTHORIZED ACCESS TO THE DEVICE

IEC61850/MMS does not provide any authentication mechanisms. If the write access for IEC61850/MMS is activated, every client that can access the device using TCP/IP is capable of changing the settings of the device. This in turn can result in an incorrect configuration of the device and to failures in the network.

Only activate the write access if you have taken additional measures (for example Firewall, VPN, etc.) to eliminate the risk of unauthorized access.

Failure to follow these instructions can result in equipment damage.

- To allow the MMS client to change the settings, mark the *Write access* checkbox, and click the button.

■ Offline configuration

The device allows you to download the ICD file using the graphical user interface. This file contains the properties of the device described with SCL and enables you to configure the substation without directly connecting to the device.

- Open the *Advanced > Industrial Protocols > IEC61850-MMS* dialog.
- To load the ICD file to your PC, click the  button and then the *Download* item.

■ Monitoring the device

The IEC61850/MMS server integrated into the device allows you to monitor multiple statuses of the device by means of the Report Control Block (RCB). Up to 5 MMS clients can register for a Report Control Block at the same time.

The device allows the following statuses to be monitored:

| Class | RCB object | Description |
|---------|-------------|--|
| LN LPHD | TmpAlm | Changes when the temperature measured in the device exceeds or falls below the set temperature thresholds. |
| | PhyHealth | Changes when the status of the LPHD.TmpAlm RCB object changes. |
| LN LPHD | TmpAlm | Changes when the temperature measured in the device exceeds or falls below the set temperature thresholds. |
| | PwrSupAlm | Changes when 1 of the redundant power supplies fails or starts operating again. |
| | PhyHealth | Changes when the status of the LPHD.PwrSupAlm or LPHD.TmpAlm RCB object changes. |
| LN LBRI | RstpRoot | Changes when the device takes over or relinquishes the role of the root bridge. |
| | RstpTopoCnt | Changes when the topology changes due to a change of the root bridge. |
| LN LCCH | ChLiv | Changes when the link status of the physical port changes. |
| LN LPCP | PhyHealth | Changes when the link status of the physical port changes. |

Table 32: Statuses of the device that can be monitored with IEC 61850/MMS

15.2 Modbus TCP

Modbus TCP is an application layer messaging protocol providing client/server communication between the client and devices connected in Ethernet TCP/IP networks.

The *Modbus TCP* function allows you to install the device in networks already using *Modbus TCP* and retrieve information saved in the registers in the device.

15.2.1 Client/Server Modbus TCP/IP Mode

The device supports the client/server model of Modbus TCP/IP. This device operates as a server in this constellation and responds to requests from a client for information saved in the registers. The client / server model uses four types of messages to exchange data between the client and server:

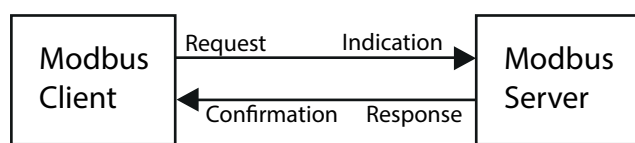

Figure 58: Client/Server Modbus TCP/IP Mode

- ▶ Modbus TCP/IP Request, the client creates a request for information and sends it to the server.
- ▶ Modbus TCP/IP Indication, the server receives a request as an indication that a client requires information.
- ▶ Modbus TCP/IP Response, when the required information is available, the server sends a reply containing the requested information. When the requested information is unavailable, the server sends an Exception Response to notify the client of the error detected during the processing. The Exception Response contains an exception code indicating the reason for the detected error.
- ▶ Modbus TCP/IP Confirmation, the client receives a response from the server, containing the requested information.

15.2.2 Supported Functions and Memory Mapping

The device supports functions with the public codes `0x03Read Holding Registers` and `0x05Write Single Coil`. The codes allow the user to read information saved in the registers such as the system information, including the system name, system location, software version, IP address, MAC address. The codes also allow the user to read the port information and port statistics. The `0x05` code allows the user to reset the port counters individually or globally.

The following list contains definitions for the values entered in the `Format` column:

- ▶ **Bitmap:** a group of 32-bits, encoded into the Big-endian byte order and saved in 2 registers. Big-endian systems save the most significant byte of a word in the smallest address and save the least significant byte in the largest address.
- ▶ **F1:** 16-bit unsigned integer
- ▶ **F2:** Enumeration - power supply alarm
 - 0 = power supply good
 - 1 = power supply failure detected
- ▶ **F3:** Enumeration - OFF/ON
 - 0 = Off
 - 1 = On
- ▶ **F4:** Enumeration - port type
 - 0 = Giga - Gigabit Interface Converter (GBIC)
 - 1 = Copper - Twisted Pair (TP)
 - 2 = Fiber - 10 Mb/s
 - 3 = Fiber - 100 Mb/s
 - 4 = Giga - 10/100/1000 Mb/s (triple speed)
 - 5 = Giga - Copper 1000 Mb/s TP
 - 6 = Giga - Small Form-factor Pluggable (SFP)
- ▶ **F9:** 32-bit unsigned long
- ▶ **String:** octets, saved in sequence, 2 octets per register.

■ Modbus TCP/IP Codes

The table below lists addresses that allow the client to reset port counters and retrieve specific information from the device registers.

■ Port Information

| Address | Qty | Description | Min | Max | Step | Unit | Format |
|---------|-----|---------------------|-----|-----|------|------|--------|
| 0400 | 1 | Port 1 Type | 0 | 6 | 1 | - | F4 |
| 0401 | 1 | Port 2 Type | 0 | 6 | 1 | - | F4 |
| | | ... | | | | | |
| 043F | 1 | Port 64 Type | 0 | 6 | 1 | - | F4 |
| 0440 | 1 | Port 1 Link Status | 0 | 1 | 1 | - | F1 |
| 0441 | 1 | Port 2 Link Status | 0 | 1 | 1 | - | F1 |
| | | ... | | | | | |
| 047F | 1 | Port 64 Link Status | 0 | 1 | 1 | - | F1 |
| 0480 | 1 | Port 1 STP State | 0 | 1 | 1 | - | F1 |
| 0481 | 1 | Port 2 STP State | 0 | 1 | 1 | - | F1 |

Table 33: Port Information

| Address | Qty | Description | Min | Max | Step | Unit | Format |
|---------|-----|-----------------------|-----|-----|------|------|--------|
| | | ... | | | | | |
| 04BF | 1 | Port 64 STP State | 0 | 1 | 1 | - | F1 |
| 04C0 | 1 | Port 1 Activity | 0 | 1 | 1 | - | F1 |
| 04C1 | 1 | Port 2 Activity | 0 | 1 | 1 | - | F1 |
| | | ... | | | | | |
| 04FF | 1 | Port 64 Activity | 0 | 1 | 1 | - | F1 |
| 0500 | 1 | Port 1 Counter Reset | 0 | 1 | 1 | - | F1 |
| 0501 | 1 | Port 2 Counter Reset | 0 | 1 | 1 | - | F1 |
| | | ... | | | | | |
| 053F | 1 | Port 64 Counter Reset | 0 | 1 | 1 | - | F1 |

Table 33: Port Information

■ Port Statistics

| Address | Qty | Description | Min | Max | Step | Unit | Format |
|---------|-----|--|-----|------------|------|------|--------|
| 0800 | 1 | Port1 - Number of bytes received | 0 | 4294967295 | 1 | - | F9 |
| 0802 | 1 | Port1 - Number of bytes sent | 0 | 4294967295 | 1 | - | F9 |
| 0804 | 1 | Port1 - Number of frames received | 0 | 4294967295 | 1 | - | F9 |
| 0806 | 1 | Port1 - Number of frames sent | 0 | 4294967295 | 1 | - | F9 |
| 0808 | 1 | Port1 - Total bytes received | 0 | 4294967295 | 1 | - | F9 |
| 080A | 1 | Port1 - Total frames received | 0 | 4294967295 | 1 | - | F9 |
| 080C | 1 | Port1 - Number of broadcast frames received | 0 | 4294967295 | 1 | - | F9 |
| 080E | 1 | Port1 - Number of multicast frames received | 0 | 4294967295 | 1 | - | F9 |
| 0810 | 1 | Port1 - Number of frames with CRC error | 0 | 4294967295 | 1 | - | F9 |
| 0812 | 1 | Port1 - Number of oversized frames received | 0 | 4294967295 | 1 | - | F9 |
| 0814 | 1 | Port1 - Number of bad fragments rcvd(<64 bytes) | 0 | 4294967295 | 1 | - | F9 |
| 0816 | 1 | Port1 - Number of jabber frames received | 0 | 4294967295 | 1 | - | F9 |
| 0818 | 1 | Port1 - Number of collisions occurred | 0 | 4294967295 | 1 | - | F9 |
| 081A | 1 | Port1 - Number of late collisions occurred | 0 | 4294967295 | 1 | - | F9 |
| 081C | 1 | Port1 - Number of 64-byte frames rcvd/sent | 0 | 4294967295 | 1 | - | F9 |
| 081E | 1 | Port1 - Number of 65-127 byte frames rcvd/sent | 0 | 4294967295 | 1 | - | F9 |
| 0820 | 1 | Port1 - Number of 128-255 byte frames rcvd/sent | 0 | 4294967295 | 1 | - | F9 |
| 0822 | 1 | Port1 - Number of 256-511 byte frames rcvd/sent | 0 | 4294967295 | 1 | - | F9 |
| 0824 | 1 | Port1 - Number of 512-1023 byte frames rcvd/sent | 0 | 4294967295 | 1 | - | F9 |
| 0826 | 1 | Port1 - Number of 1023-MAX byte frames rcvd/sent | 0 | 4294967295 | 1 | - | F9 |
| 0828 | 1 | Port1 - Number of Mac Error Packets | 0 | 4294967295 | 1 | - | F9 |
| 082A | 1 | Port1 - Number of dropped received packets | 0 | 4294967295 | 1 | - | F9 |
| 082C | 1 | Port1 - Number of multicast frames sent | 0 | 4294967295 | 1 | - | F9 |
| 082E | 1 | Port1 - Number of broadcast frames sent | 0 | 4294967295 | 1 | - | F9 |

Table 34: Port Statistics

| Address | Qty | Description | Min | Max | Step | Unit | Format |
|---------|-----|---|-----|------------|------|------|--------|
| 0830 | 1 | Port1 - Number of <64 byte fragments w/ good CRC | 0 | 4294967295 | 1 | - | F9 |
| | | ... | | | | | |
| 147E | 1 | Port64 - Number of <64 byte fragments w/ good CRC | 0 | 4294967295 | 1 | - | F9 |

Table 34: Port Statistics

15.2.3 Example Configuration

In this example, you configure the device to respond to client requests. The prerequisite for this configuration is that the client device is configured with an IP address within the given range. The *Write access* function remains inactive for this example. When you activate the *Write access* function, the device allows you to reset the port counters only. In the default configuration the *Modbus TCP* and *Write access* functions are inactive.

NOTICE

RISK OF UNAUTHORIZED ACCESS TO THE DEVICE

The *Modbus TCP* protocol does not provide any authentication mechanisms. If the write access for *Modbus TCP* is activated, every client that can access the device using TCP/IP is capable of changing the settings of the device. This in turn can result in an incorrect configuration of the device and to failures in the network.

Only activate the write access if you have taken additional measures (for example Firewall, VPN, etc.) to eliminate the risk of unauthorized access.

Failure to follow these instructions can result in equipment damage.

- Open the *Device Security > Management Access > IP Access Restriction* dialog.
- To add a table entry, click the  button.
- Specify the IP address range, in *Index* row 2, enter 10.17.1.0/29 in the *IP address range* column.
- Verify that the *Modbus TCP* function is activated.
- To activate the range, mark the *Active* checkbox.
- Open the *Diagnostics > Status Configuration > Security Status > Global* dialog.
- Verify that the *Modbus TCP active* checkbox contains a mark.
- Open the *Advanced > Industrial Protocols > Modbus TCP* dialog.
- The standard *Modbus TCP* listening port, port 502, is the default value. However, if you wish to listen on another TCP port, enter the value for the listening port in the *TCP port* field.
- To enable the function, select the *On* radio button in the *Operation* frame.

When you enable the *Modbus TCP* function, the *Security Status* function detects the activation and displays an alarm in the *Basic Settings > System* dialog, *Security status* frame.

```

enable
network management access add 2
network management access modify 2 ip 10.17.1.0
network management access modify 2 mask 29
network management access modify 2 modbus-tcp enable
network management access operation configure
security-status monitor modbus-tcp-enabled
modbus-tcp operation
modbus-tcp port <1..65535>

show modbus-tcp
Modbus TCP/IP server settings
-----
Modbus TCP/IP server operation.....enabled
Write-access.....disabled
Listening port.....502
Max number of sessions.....5
Active sessions.....0
show security-status monitor
Device Security Settings
Monitor
-----
Password default settings unchanged.....monitored
...
Write access using HiDiscovery is possible...monitored
Loading unencrypted configuration from ENVM...monitored
IEC 61850 MMS is enabled.....monitored
Modbus TCP/IP server active.....monitored
show security-status event
Time stamp          Event                      Info
-----
2014-01-01 01:00:39 password-change (10)      -
.....
2014-01-01 01:00:39 ext-nvm-load-unsecure (21) -
2014-01-01 23:47:40 modbus-tcp-enabled (23)  -
show network management access rules 1
Restricted management access settings
-----
Index.....1
IP Address.....10.17.1.0
Prefix Length.....29
HTTP.....yes
SNMP.....yes
Telnet.....yes
SSH.....yes
HTTPS.....yes
IEC61850-MMS.....yes
Modbus TCP/IP.....yes
Active.....[x]

```

Change to the Privileged EXEC mode.

Creates the entry for the address range in the network. Number of the next available index in this example: 2.

Specifies the IP address.

Specifies the netmask.

Specifies that *Modbus TCP* is allowed to have management access.

Enables the IP access restriction.

Change to the Configuration mode.

Specifies that the device monitors the activation of the *Modbus TCP* server.

Activates the *Modbus TCP* server.

Specify the TCP port for *Modbus TCP* communication (optionally). The default value is port 502.

Display the *Modbus TCP* Server settings.

Display all security-status settings.

Display occurred security status events.

Display the restricted management access rules for index 1.

15.3 EtherNet/IP

EtherNet/IP is accepted worldwide as a standardized industrial communication protocol and is maintained by the Open DeviceNet Vendor Association (ODVA). The protocol is based on the widely used standard Ethernet transport protocols TCP/IP and UDP/IP. *EtherNet/IP* is supported by leading manufacturers, thus providing a wide base for effective data communication in the industry sector.

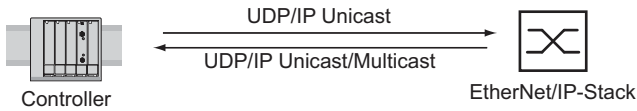

Figure 59: *EtherNet/IP* network

EtherNet/IP adds the industry protocol, CIP (Common Industrial Protocol) to the standard Ethernet protocols. *EtherNet/IP* implements CIP at the Session layer and above and adapts CIP to the specific *EtherNet/IP* technology at the Transport layer and below. In the case of automation applications, *EtherNet/IP* implements CIP on the application level. Therefore, *EtherNet/IP* is ideally suited to the industrial control technology sector.

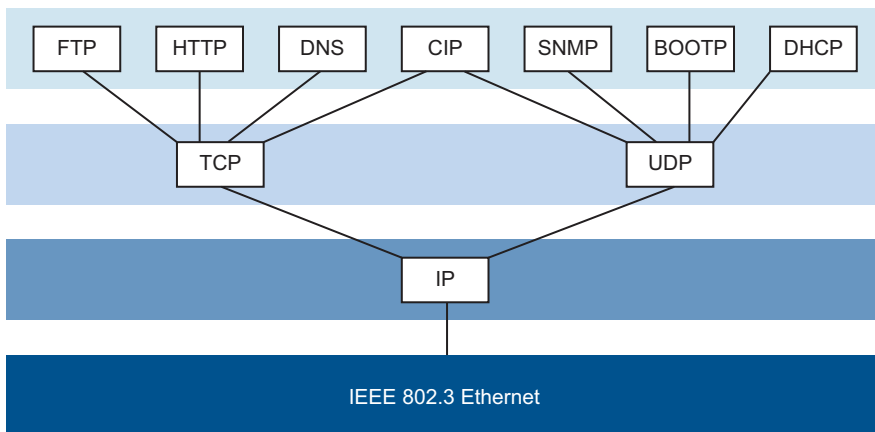

Figure 60: IEEE802.3 *EtherNet/IP*

In particular, you will find *EtherNet/IP* in the USA and in conjunction with Rockwell controllers.

For detailed information on *EtherNet/IP*, see the ODVA home page at www.odva.org/Home/ODVATECHNOLOGIES/EtherNetIP.aspx.

15.3.1 Integration into a Control System

Use the following steps to integrate the device into a Control System:

- Open the *Switching > IGMP Snooping > IGMP Snooping Global* dialog.

- Verify that the IGMP Snooping function is activated.
- Open the *Advanced > Industrial Protocols > EtherNet/IP* dialog. Verify that the *EtherNet/IP* function is activated.
- Open the *Advanced > Industrial Protocols > EtherNet/IP* dialog.
- To save the EDS as a zip file on your PC, click *Download*. The ZIP file contains the *EtherNet/IP* configuration file and the icon used to configure the controller to connect to the device.

Note: If *EtherNet/IP* and the routing function are enabled at the same time, malfunctions are possible with *EtherNet/IP*, for example, in connection with “RS Who”. Therefore, if the routing function is active, then disable the routing function on the device.

- To disable the routing function on the device, open the *Routing > Routing Global* dialog and in the *Operation* frame, click the *Off* radio button.

To disable the *Routing* function, perform the following steps:

- | | |
|--|---|
| <ul style="list-style-type: none"> enable configure no ip routing | <ul style="list-style-type: none"> Change to the Privileged EXEC mode. Change to the Configuration mode. Deactivate the <i>Routing</i> function on the device. |
|--|---|

■ Configuration of a PLC using the example of Rockwell software

- Open the “EDS Hardware Installation Tool” of RSLinx.
- Use the “EDS Hardware Installation Tool” to add the EDS file.
- Restart the “RSLinx” service so that RSLinx takes over the EDS file of the device.
- Use RSLinx to check whether RSLinx has detected the device.
- Open your Logix 5000 project.
- Integrate the device into the Ethernet port of the controller as a new module (Generic Ethernet Module).

| Setting | I/O connection | Input only | Listen only |
|---------------------------------|--------------------------|--------------------------|---------------------------------|
| Comm Format | Data - DINT | Data - DINT | Input data - DINT - Run/Program |
| IP Address | IP address of the device | IP address of the device | IP address of the device |
| Input Assembly Instance | 2 | 2 | 2 |
| Input Size | 7 | 7 | 7 |
| Input Size | 7 | 7 | 7 |
| Output Assembly Instance | 1 | 254 | 255 |
| Output Size | 1 | 0 | 0 |
| Output Size | 1 | 0 | 0 |
| Configuration Assembly Instance | 3 | 3 | 3 |
| Configuration Size | 0 | 0 | 0 |

Table 35: Settings for integrating a Generic Ethernet Module

- In the module properties, enter a value of at least 100 ms for the Request Packet Interval (RPI).

Note: Monitoring the I/O connection to the CPU of the device as a failure can result in a system failure. Therefore, monitoring the I/O connection as a failure criterion is less suitable.

The I/O connection between the programmable logic controller (PLC) and the device can be interrupted by a management program. For example, a management station can saturate the CPU of the device with higher priority Real Time (RT) data. In this case, the device can still transmit or receive data packets and the system remains operational.

■ Example of integration from the Sample Code Library

The Sample Code Library is a website from Rockwell. The object of the website is to provide users with a place where they can exchange their best architecture integration applications.

On the website <http://samplecode.rockwellautomation.com>, search for catalog number 9701. This is the catalog number of an example for integrating the Hirschmann device into RS Logix 5000 rel. 16, PLC firmware release 16.

15.3.2 EtherNet/IP Entity Parameters

The following paragraphs identify the objects supported by the device.

Save the entire device configuration. When the device receives a set request, it responds to the request during the configuration save process. The LEDs flash until the device finishes saving the configuration.

■ Identity object

The device supports the identity object (Class Code 0x01) of *EtherNet/IP*. The Hirschmann manufacturer ID is 634. Hirschmann uses the ID 44 (0x2C) to indicate the product type "Managed Ethernet Switch".

The following table lists the Instance attributes. Only instance 1 is available:

| Id | Attribute | Access Rule | Data type | Description |
|----|---------------|-------------|--------------------------------------|---|
| 1 | Vendor ID | Get | UINT | Hirschmann634 |
| 2 | Device Type | Get | UINT | Managed Ethernet Switch 44 (0x2C) (0x2C) |
| 3 | Product Code | Get | UINT | Product Code: mapping is defined for every device type |
| 4 | Revision | Get | STRUCT of: USINT MajorUSINT Minor | Revision of the EtherNet/IP implementation, 2.1. |
| 5 | Status | Get | WORD | Support for the following Bit status only: Bit 0: Owned (always 1) Bit 2: Configured (always 1) Bit 4 -7: Extend Device Status value 3: No I/O connection established, value 7: At least one I/O connection established, all in idle mode. |
| 6 | Serial number | Get | UDINT | Serial number of the device (contains last 3 Bytes of MAC address). |
| 7 | Product name | Get | Short String (max. 32 Byte) | Displayed as "Hirschmann" + product family + product ID + software variant. |

■ TCP/IP Interface Object

The device supports only Instance 1 of the TCP/IP Interface Object (Class Code 0xf5, F5_H, 245) of *EtherNet/IP*.

Depending on the write access status, the device stores the complete configuration in its flash memory. Saving the configuration file can take up to 10 seconds. If the save process is interrupted, for example, by a disruption of the input power, the device can become inoperable.

Note: The device replies to the configuration change Get Request with a Response even if saving of the configuration has not yet been completed.

The following table lists the Class attributes:

| Id | Attribute | Access Rule | Data type | Description |
|----|--------------------|-------------|-----------|---|
| 1 | Revision | Get | UINT | Revision of this object: 3 |
| 2 | Max Instance | Get | UINT | Maximum instance number: 1 |
| 3 | Number of instance | Get | UINT | Number of object instances currently created: 1 |

The following table lists the attributes of Instance 1:

| Id | Attribute | Access Rule | Data type | Description |
|----|----------------------------|-------------|--|---|
| 1 | Status | Get | DWORD | Interface Status: Bit 0-3: 0 Interface not configured, 1 Interface contains valid config Bit 6: AcdStatus (default 0) Bit 7: AcdFault (default 0) |
| 2 | Interface Capability flags | Get | DWORD | Bit 0: BOOTP Client Bit 1: DNS Client Bit 2: DHCP Client Bit 3: DHCP-DNS Update Bit 4: Configuration settable (within CIP), Other bits reserved (0). Bit 7: AcdCapable (TRUE shall indicate that the device is ACD capable) |
| 3 | Config Control | Set/Get | DWORD | Bit 0-3: Value 0 using stored config Value 1 using BOOTP Value 2 using DHCP Bit 4: 1 device uses DNS for name lookup (always 0 because not supp.) Other bits reserved (0) |
| 4 | Physical Link Object | Get | STRUCT of:UINT Path sizeEPATH Path | Path to the Physical Link Object, always {0x20,0xF6,0x24,0x01} describing instance 1 of the Ethernet Link Object. |
| 5 | Interface Configuration | Set/Get | STRUCT of:UDINT IP addressUDINT NetmaskUDINT Gateway addressUDINT Name server 1UDINTName server 2STRING Domain name | IP Stack Configuration (IP-Address, Netmask, Gateway, 2 Name servers (DNS, if supported) and the domain name). |
| 6 | Host Name | Set/Get | STRING | Host Name (for DHCP DNS Update). |
| 7 | Safety Network Number | | | Not supported |
| 8 | TTL Value | Get/Set | USINT | Time to live value for IP multicast packets. (1–255) The default values: TTL = 1 |
| 9 | Mcast Config | Get/Set | STRUCT of:USINT Alloc control, USINT reserved, UINT Num Mcast, UDINT Mcast Start Addr | Alloc Control = 0 Number of IP multicast addresses = 32 Multicast start address = 239.192.1.0 |
| 10 | SelectedAcd | Get/Set | BOOL | Enable ACD (1 default).Disable ACD (0) |
| 11 | LastConflictDetected | Get | STRUCT of:USINT AcdActivity,Array of 6 USINT, RemoteMAC Array of 28 USINT ArpPdu | ACD Diagnostic Parameters |

The following table lists the Hirschmann extensions to the TCP/IP Interface Object:

| Id | Attribute | Access Rule | Data type | Description |
|----------|-------------------|-------------|--|---|
| 100=0x64 | Cable Test | Set/Get | STRUCT of:USINT Interface,USINT Status | STRUCT of: USINT Interface USINT Status (active (1) Success (2) Failure (3) Uninitialized (4) |
| 101=0x65 | Cable Pair Size | Get | USINT | Size of the Cable Test Result STRUCT of:2 Pair for 100BASE4 Pair for 1000BASE |
| 102=0x66 | Cable Test Result | Get | STRUCT of: USINT Interface,USINT CablePair,USINT CableStatus,USINT CableMinLength, USINT CableMaxLengthUSINTCableF ailureLocation | 100BASE:{ {Interface,CablePair1,CableStatus, CableMinLength, CableMaxLength, CableFailureLocation} {Interface,CablePair2,CableStatus, CableMinLength, CableMaxLength, CableFailureLocation} } 1000BASE:{ {Interface,CablePair1,CableStatus, CableMinLength, CableMaxLength, CableFailureLocation} {Interface,CablePair2,CableStatus, CableMinLength, CableMaxLength, CableFailureLocation} {Interface,CablePair3,CableStatus, CableMinLength, CableMaxLength, CableFailureLocation} {Interface,CablePair4,CableStatus, CableMinLength, CableMaxLength, CableFailureLocation} } |

■ Ethernet Link object

Specify at least 1 instance on the device, for example, Instance 1 is the CPU Ethernet interface instance. (Class Code 0xf6, F6_H, 246) of *EtherNet/IP*.

| Id | Attribute | Access Rule | Data type | Description |
|----|--------------------|-------------|---|--|
| 1 | Interface Speed | Get | UDINT | Used interface speed in Mbits/s (10, 100, 1000, ...). 0 is used when the speed has not been determined or is invalid because of errors. |
| 2 | Interface Flags | Get | DWORD | Interface Status Flags: Bit 0: Link State (1=Link) Bit 1: Halfduplex(0)/Full duplex(1) Bits 2-4: Autoneg Status 0 Autoneg in Progress 1 Autoneg failed 2 failed but Speed detected 3 Autoneg success 4 No Autoneg Bit 5: manual configuration require reset (always 0 because not needed) Bit 6: hardware error. |
| 3 | Physical Address | Get | ARRAY of 6 USINTs | MAC address of physical interface. |
| 4 | Interface Counters | Get | STRUCT of: MIB II CountersEach UDINT | InOctets, InUcastPackets, InNUcastPackets, InDiscards, InErrors, InUnknownProtos, OutOctets, OutUcastPackets, OutNUcastPackets, OutDiscards, OutErrors. |

| Id | Attribute | Access Rule | Data type | Description |
|----|-------------------|-------------|---|---|
| 5 | Media Counters | Get | STRUCT of: Ethernet MIB CountersEachUDINT | Alignment Errors, FCS Errors, Single Collision, Multiple Collision, SQE Test Errors, Deferred Transmissions, Late Collisions, Excessive Collisions, MAC TX Errors, Carrier Sense Errors, Frame Too Long, MAC RX Errors. |
| 6 | Interface Control | Get/Set | STRUCT of: WORD Control BitsUINT Forced lface Speed | Control Bits: Autoneg enable/disable (Bit 0, enable=1) Duplex mode (Bit 1, full duplex=1), if Autoneg disabled (Bit 0 set to 0). Interface speed in MBits/s: 10,100,..., if Autoneg disabled (Control Bit 0 set to 0). |
| 7 | Interface type | Get | USINT | Type of interface: Value 0: Unknown interface type, Value 1: The interface is internal, Value 2: Twisted-pair, Value 3: Optical fiber. |
| 3 | Interface state | Get | USINT | Current state of the interface: Value 0: Unknown interface state, Value 1: The interface is enabled, Value 2: The interface is disabled, Value 3: The interface is testing |
| 9 | Admin State | Set/Get | USINT | Administrative state: Value 1: Enable the interface, Value 2: Disable the interface. |
| 10 | Interface label | Get | SHORT-STRING | Human readable ID |

The following table lists the Hirschmann extensions to the Ethernet Link Object:

| Id | Attribute | Access Rule | Data type | Description |
|----------|---|-------------|---|---|
| 100=0x64 | Ethernet Interface Index | Get | USINT | Interface/Port Index (ifIndex out of MIBII) |
| 101=0x65 | Port Control | Get/Set | DWORD | Bit 0 (RO): Link state 0 link down 1 link up Bit 1 (R/W): Link admin state 0 disabled 1 enabled Bit 8 (RO): Access violation alarm Bit 9 (RO): Utilization alarm |
| 102=0x66 | Interface Utilization | Get | USINT | The existing Counter out of the private MIB hm2IDiagIfaceUtilization is used. Utilization in percentage (Unit 1% = 100, %/100). RX Interface Utilization. |
| 103=0x67 | Interface Utilization Alarm Upper Threshold | Get/Set | USINT | Within this parameter the variable hm2DiagIfaceUtilizationAlarmUpperThreshold can be accessed. Utilization in percentage (Unit 1% = 100). RX Interface Utilization Upper Limit. |
| 104=0x68 | Interface Utilization Alarm Lower Threshold | Get/Set | USINT | Within this parameter the variable hm2DiagIfaceUtilizationAlarmLowerThreshold can be accessed. Utilization in percentage (Unit 1% = 100). RX Interface Utilization Lower Limit. |
| 105=0x69 | Broadcast limit | Get/Set | USINT | Broadcast limiter Service (Egress BC-Frames limitation, 0 = disabled), Frames/second |
| 106=0x6A | Ethernet Interface Description | Get/Set | STRING [max. 64 Bytes] even number of Bytes | Interface/Port Description (from MIB II ifDescr), for example "Unit: 1 Slot: 2 Port: 1 - 10/100 Mbit TX", or "unavailable", max. 64 Bytes. |

| Id | Attribute | Access Rule | Data type | Description |
|----------|-----------------|-------------|--|--|
| 107=0x6B | Port Monitor | Get/Set | DWORD | Bit 0: Link Flap 1 ON 0 OFF Bit 1: CRC/Fragment 1 ON 0 OFF Bit 2: Duplex Mismatch 1 ON 0 OFF Bit 3: Overload-Detection 1 ON 0 OFF Bit 4: Link-Speed/ Duplex Mode 1 ON 0 OFF Bit 5-6: Action (to be performed in the event) Bit 01: Deactivate Port Bit 10: Send Trap Bit 7-11: Active Condition (displays which condition caused an action to occur) Bit 00001: Link Flap Bit 00010: CRC/Fragments Bit 00100: Duplex Mismatch Bit 01000: Overload-Detection Bit 10000: Link-Speed/ Duplex mode) Bit 12-15: Reserved (always 0) |
| 108=0x6C | Quick Connect | Get/Set | USINT | Enable /disable Quick Connect on the interface. If you enable Quick Connect, then the device sets the port speed to 100FD, disables auto-negotiation, and spanning tree on the interface. Quick Connect (1 ON, 0 OFF) |
| 109=0x6D | SFP Diagnostics | Get | STRUCT of: STRING Module type SHORT-STRING Serial Number USINT Connector USINT Supported DINT Temperature °C DINT Tx Power in mW DINT Rx Power in mW DINT Tx Power in dBm DINT Rx Power in dBm | STRUCT of: { STRING Module type UDINT Serial Number USINT Connector USINT Supported DINT Temperature °C DINT Tx Power in mW DINT Rx Power in mW DINT Tx Power in dBm DINT Rx Power in dBm |

■ Switch Agent object

The device supports the Hirschmann vendor specific Ethernet Switch Agent Object (Class Code 0x95, 95_H, 149) for the device configuration and information parameters with Instance 1.

The following table lists the Instance attributes of the Ethernet Switch Agent object:

| Switch Status | Id 0x1 | DWORD (32 Bit) RO |
|---------------|--------|---|
| | Bit 0 | Like the signal contact, the value indicates the Device Overall state (0 ok, 1 failed). |
| | Bit 1 | Device Security Status (0 ok, 1 failed) |
| | Bit 2 | Power Supply 1 (0 ok, 1 failed or not existing) |
| | Bit 3 | Power Supply 2 (0 ok, 1 failed or not existing) |
| | Bit 4 | Reserved |
| | Bit 5 | Reserved |
| | Bit 6 | Signal Contact 1 (0 closed, 1 open) |
| | Bit 7 | Signal Contact 2 (0 closed, 1 open or not existing) |

| Switch Status | Id 0x1 | DWORD (32 Bit) RO |
|------------------------------------|---------------|--|
| | Bit 8 | Reserved |
| | Bit 9 | Temperature (0 ok, 1 Failure) |
| | Bit 10 | Module removed (1 removed) |
| | Bit 11 | ACA21/ACA22 removed (1 removed) |
| | Bit 12 | ACA31 removed (1 removed) |
| | Bit 13 | Reserved |
| | Bit 14 | Reserved |
| | Bit 15 | Reserved |
| | Bit 16 | Reserved |
| | Bit 17 | Reserved |
| | Bit 18 | Reserved |
| | Bit 19 | Reserved |
| | Bit 20 | Reserved |
| | Bit 21 | Reserved |
| | Bit 22 | Reserved |
| | Bit 23 - 30 | Network Redundancy: Bit 23: MRP Bit 24: PRP Bit 25: HSR Bit 26: RSTP Bit 27: LAG Bit 28: DLR Bit 29-30: Reserved No Network Redundancy: (0 enabled) |
| | Bit 31 | Connection Error: (1 Failure) |
| Switch Temperature | Id 0x2 | Struct{INT RO Temperature °F INT RO Temperature °C} |
| | | |
| Reserved | Id 0x3 | UDINT (unsigned 32 Bit int) RO |
| | | Always 0, attribute is reserved for future use. |
| Switch Max Ports | Id 0x4 | UINT (16 Bit) RO Maximum number of Ethernet Switch Ports |
| | | |
| Multicast Settings (IGMP Snooping) | Id 0x5 | WORD (16Bit) RW |
| | Bit 0 RW | IGMP Snooping (1 enabled, 0 disabled) |
| | Bit 1 RW | IGMP Querier (1 enabled, 0 disabled) |
| | Bit 2 RO | IGMP Querier Mode (1 Querier, 0=Non-Querier) |
| | Bit 4 - 6 RW | IGMP Querier Packet Version V1 = 1 V2 = 2 V3 = 3 Off = 0 IGMP Querier disabled |
| | Bit 8 - 10 RW | Treatment of Unknown Multicasts (Railswitch only): 0 = Send To All Ports 1 = Send To Query Ports 2 = Discard |

| | | |
|------------------------------|--|---|
| Switch Existing Ports | Id 0x6 Per Bit starting with Bit 0 (=Port 1) | ARRAY OF DWORD (32 bit) RO Bitmask of existing Switch Ports 1=Port existing 0=Port not available. Array (bit mask) size is adjusted to the size of maximum number of Switch ports (for example max. 28 Ports => 1 DWORD is used (32 Bit)). |
| Switch Port Control | Id 0x7 Per Bit starting with Bit 0 (=Port 1) | ARRAY OF DWORD (32 bit) RW Bitmask Link Admin Status Switch Ports 0=Port enabled 1=Port disabled Array (bit mask) size is adjusted to the size of maximum number of Switch ports (for example max. 28 Ports => 1 DWORD is used (32 Bit)). |
| Switch Ports Mapping | Id 0x8 Starting with Index 0 (=Port 1) | ARRAY OF USINT (BYTE, 8 bit) RO Instance number of the Ethernet-Link-Object All Ethernet Link Object Instances for the existing Ethernet Switch Ports (1..N, maximum number of ports). When the entry is 0, the Ethernet Link Object for this port does not exist |
| Switch Action Status | Id 0x9 | DWORD (32 Bit) RO, Status of the last executed action (for example config save, software update, etc.) |
| | Bit 0 | Flash Save Configuration In Progress/Flash Write In Progress |
| | Bit 1 | Flash Save Configuration Failed/Flash Write Failed |
| | Bit 4 | Configuration changed (configuration not in sync. between running configuration |

The Hirschmann specific Ethernet Switch Agent Object provides you with the additional vendor specific service, with the Service-Code 35H for saving the Switch configuration. When you send a request from your PC to save a device configuration, the device sends a reply after saving the configuration in the flash memory.

■ Base Switch object (0x51)

The Base Switch object provides the CIP application-level interface to basic status information for a Managed Ethernet switch (revision 1).

Only Instance 1 of the Base Switch (Class Code 0x51) is available.

The following table lists the Instance attributes:

| Id | Attribute | Access Rule | Data type | Description |
|----|----------------------------|-------------|----------------|--|
| 1 | Device Up Time | Get | UDINT | Time since the device powered up |
| 2 | Total port count | Get | UDINT | Number of physical ports |
| 3 | System Firmware Version | Get | SHORT-STRING | Human readable representation of System Firmware Version |
| 4 | Power source | Get | WORD | Status of switch power source |
| 5 | Port Mask Size | Get | UINT | Number of DWORD in port array attributes |
| 6 | Existing ports | Get | Array of DWORD | Port Mask |
| 7 | Global Port Admin State | Get | Array of DWORD | Port Admin Status |
| 8 | Global Port link Status | Get | Array of DWORD | Port Link Status |
| 9 | System Boot Loader Version | Get | SHORT-STRING | Readable System Firmware Version |

| Id | Attribute | Access Rule | Data type | Description |
|----|----------------|-------------|-----------|--|
| 10 | Contact Status | Get | UDINT | Switch Contact Closure |
| 11 | Aging Time | Get | UDINT | Range 10...1000000 0= Learning off Default = 300 |
| 12 | Temperature C | Get | UINT | Switch temperature in degrees Celsius |
| 13 | Temperature F | Get | UINT | Switch temperature in degrees Fahrenheit |

■ Device Level Ring (0x47)

The Device Level Ring (DLR) object provides the configuration and status information interface for the DLR protocol (revision 2).

Only Instance 1 of the TCP/IP Interface Object (Class Code 0x47) is available.

The following table lists the Class attributes:

| Id | Attribute | Access Rule | Data type | Description |
|----|----------------------------------|-------------|---|---|
| 1 | Network Topology | Get | USINT | 0: Linear 1: Ring |
| 2 | Network status | Get | USINT | Current status of network. 0: normal 1: Ring Fault 2: Unexpected Loop Detection 3: Partial Network Fault 4: Rapid Fault/ Restore Cycle |
| 3 | Ring Supervisor Status | Get* | USINT | 0: Backup 1: Active Ring Supervisor 2: Normal Ring Node 3: Non-DLR topology 4: Device cannot support the Beacon Interval or Timeout |
| 4 | Ring Supervisor Config | Set* | STRUCT of: BOOL R.S Enable USINT R.S Precedence UDINT Beacon Interval UDINT Beacon Timeout UINT DLR VLAN ID | Default: FALSE Default: 0 Default: 400 Default: 1960 Default: 0 |
| 5 | Ring Faults Count | Set* | UINT | Number of ring faults since power up |
| 6 | Last Active Node on Port 1 | Get* | STRUCT of:UDINT Device IPARRY of 6 USINT MAC | Last Active node at the end of chain through port 1 of active ring supervisor during ring fault |
| 7 | Last Active Node on Port 2 | Get* | STRUCT of:UDINT Device IPARRY of 6 USINT MAC | Last Active node at the end of chain through port 2 of active ring supervisor during ring fault |
| 8 | Ring Protocol Participants Count | Get* | UINT | Number of devices in ring protocol participants list |
| 9 | Ring protocol participants list | Get* | ARRY of:STRUCT of:UDINT Device IPARRY of 6 USINTs MAC | List of devices participating in ring protocol. |
| 10 | Active Supervisor Address | Get | STRUCT of:UDINT Supervisor IPARRY of 6 USINTs Supervisor MAC | IP and or/ MAC address of the active ring supervisor |
| 11 | Active Supervisor Precedence | Get* | USINT | Precedence value of the active ring supervisor |
| 12 | Capability Flags | Get | DWORD | Describes the DLR capabilities of the device |

*The conditional attributes are implemented for devices capable of functioning in a ring.

■ Services, Connections and I/O Data

The device supports the following connection types and parameters.

| Setting | I/O connection | Input only | Listen only |
|---------------------------------|--------------------------|--------------------------|-------------------------------------|
| Comm Format: | Data - DINT | Data - DINT | Input Data - DINT - Run/ Program |
| IP Address | IP address of the device | IP address of the device | IP address of the device |
| Input Assembly Instance | 100 | 100 | 100 |
| Input Size | 32 | 32 | 32 |
| Output Assembly Instance | 150 | 152 | 153 |
| Output Size | 32 | 0 | 0 |
| Configuration Assembly Instance | 151 | 151 | 151 |
| Data Size | 10 | 10 | 10 |

Table 36: Settings for integrating a new module

The following table displays an overview of the supported EtherNet/IP requests for the objects instances.

| Service code | Identity Object | TCP/IP Interface Object | Ethernet Link Object | Switch Agent Object | Base Switch Object | DLR |
|-------------------------------------|---|---|--|--|--------------------|-----------------------------|
| Get Attribute All (0x01) | All attributes | All attributes | All attributes | All attributes | All attributes | All attributes |
| Set Attribute All (0x02) | - | Settable attributes (3,5,6,8,9,10) | Settable attributes (6,9) | - | - | Settable attributes (4,5) |
| Get Attribute Single (0x0e) | All attributes | All attributes | All attributes | All attributes | All attributes | All attributes |
| Set Attribute Single (0x10) | - | Settable attributes (3,5,6,8,9,10,0x64) | Settable attributes (6,9,0x65,0x67,0x68,0x69,6C) | Settable attributes (7) | - | Settable attributes (4,5) |
| Reset (0x05) | Parameter(0,1) | - | - | - | - | - |
| Save Configuration (0x35) | - | - | - | Save switch configuration | - | - |
| Vendor specific | - | - | - | - | - | - |
| Mac Filter(0x36) | - | - | - | Add mac-filterSTRUCT of:{ USINT VLAN-IDARRAY of 6 USINT MAC DWORD Port Mask} | - | - |
| Verify Fault Location (0x4B) | - | - | - | - | - | Verify Fault Location |
| Clear Rapid Faults (0x4C) | - | - | - | - | - | Clear Rapid Faults |
| Restart Sign On (0x4D) | - | - | - | - | - | Restart Sign On |
| Clear Gateway Partial Fault (0x04E) | - | - | - | - | - | Clear Gateway Partial Fault |
| I/O Data | Value (data types and sizes to be defined) | | Direction | | | |
| Device Status | Bitmask (see Switch Agent Attribute 1) | | Input, DWORD 32 Bit | | | |
| Link Status | Bitmask, 1 Bit per port 0 = No link 1 = Link up | | Input (DWORD 32 Bit *) | | | |

| I/O Data | Value (data types and sizes to be defined) | Direction |
|----------------------------------|--|-------------------------|
| Output Links Admin State applied | Bitmask (1 Bit per port) to acknowledge output. Link state change can be denied, for example for controller access port. 0 = Port enabled 1 = Port disabled | Input (DWORD 32 Bit *) |
| Utilization Alarm | Bitmask, 1 Bit per port 0 = No alarm 1 = Alarm on port | Input (DWORD 32 Bit *) |
| Access Violation Alarm | Bitmask, 1 Bit per port 0 = No alarm 1 = Alarm on port | Input (DWORD 32 Bit *) |
| Multicast Connections | Integer, number of connections | Input (1 DINT 32 Bit) |
| TCP/IP Connections | Integer, number of connections | Input (1 DINT 32 Bit) |
| Quick Connect Mask | Bitmask (1 Bit per port) 0 = Quick Connect is disabled 1 = Quick Connect is enabled | Input (1 DINT 32 Bit *) |
| Link Admin State | Bitmask, 1 Bit per port 0 = Port enabled 1 = Port disabled | Output, DWORDa |

■ Ethernet Link Object Instances Mapping

The table displays the assignment of the ports to the Ethernet Link Object Instances.

| Ethernet Port | Ethernet Link Object Instance |
|---------------|-------------------------------|
| CPU | 1 |
| 1 | 2 |
| 2 | 3 |
| 3 | 4 |
| 4 | 5 |
| ... | ... |

The number of ports depends on the type of hardware used. The Ethernet Link Object only exist, if the port is connected.

15.4 PROFINET

PROFINET is an industrial communication network based on Ethernet that is accepted worldwide. It is based on the widely used transport protocols TCP/IP and UDP/IP (standard). This is an important aspect for fulfilling the requirements for consistency from the management level down to the field level.

PROFINET enhances the existing Profibus technology for such applications that require fast data communication and the use of industrial IT functions.

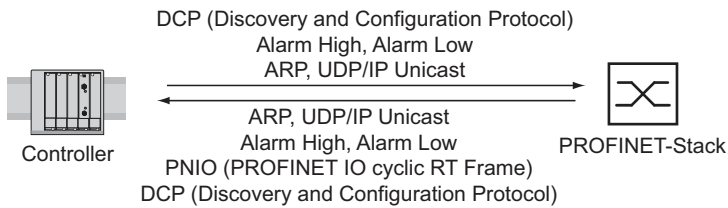

Figure 61: Communication between the Controller and the device

In particular, you will find **PROFINET** in Europe and in conjunction with Siemens controllers.

PROFINET uses the device description language GSDML (Generic Station Description Markup Language, based on XML - eXtended Markup Language) to describe devices and their properties so that they can be processed automatically. You will find the device description in the GSD(ML) file of the device.

You will find detailed information on **PROFINET** on the Internet site of the PROFIBUS Organization at <http://www.profibus.com>.

The devices conform to class B for **PROFINET**.

■ Device Models for PROFINET GSDML Version 2.3

The device creates GSDML files in the GSDML V.2.3 format. Within the GSDML file, the device is modeled according to GSDML standard V.2.2.

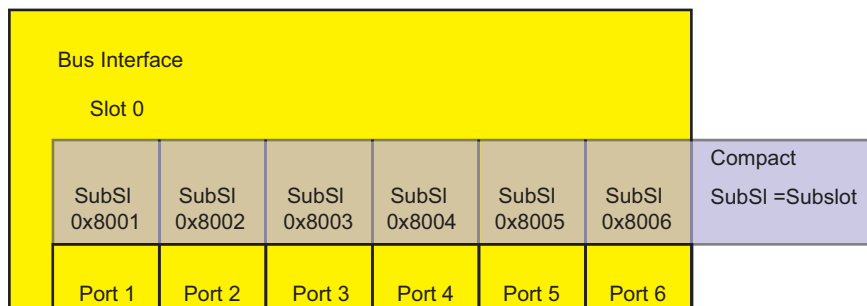

Figure 62: Compact device

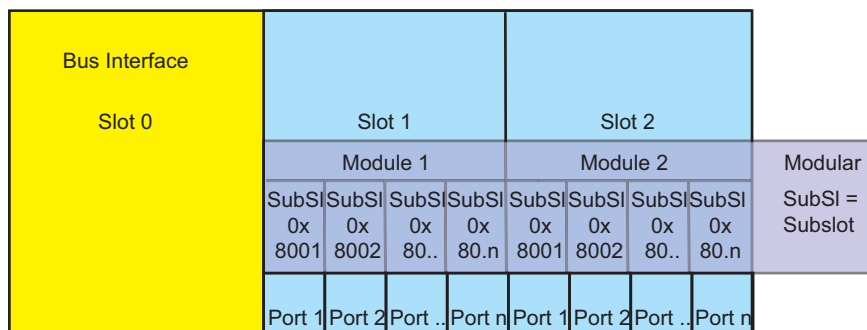

Figure 63: Modular device

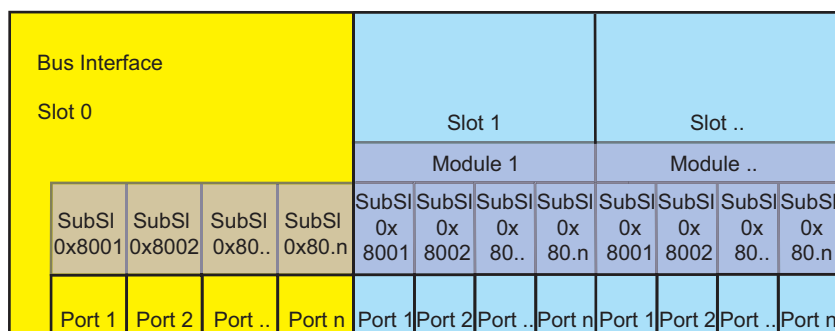

Figure 64: Mixed device

■ Graphical user interface and CLI

In *PROFINET* environments, the automation process establishes an application relation (AR) to the device when the device is set up successfully.

After the login of a user, the device displays a corresponding message via the graphical user interface and CLI.

15.4.1 Integration into a Control System

■ Preparing the device

After installing, connecting and configuring the device, proceed using the following steps:

- Open the *Basic Settings > System* dialog.
- Verify that a valid system name for the device is specified in the *System name* field.
- To save the changes temporarily, click the button.
- Open the *Basic Settings > Network* dialog.
- In the *Management interface* frame, select the *Local* radio button.
- To save the changes temporarily, click the button.
- Open the *Switching > Switching Global* dialog, mark the *VLAN unaware mode* checkbox.
- To save the changes temporarily, click the button.
- Open the *Diagnostics > Status Configuration > Device Status* dialog, *Global* and *Port* tabs.
- Configure the alarm setting and the threshold value for the alarms you want to monitor.
- To save the changes temporarily, click the button.
- Open the *Advanced > Industrial Protocols > PROFINET* dialog.
- Load the GSD(ML) file and the icon onto your local computer.
Use the following methods to get the GSD(ML) file and the icon:
 - Download the file from the *Advanced > Industrial Protocols > PROFINET* dialog.
- To enable the function, select the *On* radio button in the *Operation* frame.
- To save the changes temporarily, click the button.

■ Default values to be changed

Functions that directly affect the *PROFINET* function require the following default values to be changed. If you have obtained the device as a specially available *PROFINET* variant, these values are already predefined:

| | |
|----------|---|
| PROFINET | <i>Advanced > Industrial Protocols > PROFINET</i> dialog <ul style="list-style-type: none">- <i>Operation</i> = On- <i>Name of station</i> = <empty> |
| Network | <i>Basic Settings > Network</i> dialog <ul style="list-style-type: none">- <i>IP address assignment</i> = Local- <i>HiDiscovery protocol v1/v2Access</i> = readOnly- <i>IP address</i> = 0.0.0.0- <i>Netmask</i> = 0.0.0.0- <i>Gateway address</i> = 0.0.0.0 |
| VLAN | <i>Switching > Global</i> dialog <ul style="list-style-type: none">- <i>VLAN unaware mode</i> = marked |
| LLDP | <i>Diagnostics > LLDP</i> dialog <ul style="list-style-type: none">- <i>Transmit interval [s]</i> = 5- <i>Transmit delay [s]</i> = 1 |

■ Configuration of the PLC

The following illustrates the configuration of the PLC using the example of the Simatic S7 software from Siemens, and assumes that you are familiar with operating the software.

The device also supports Network management stations from other manufacturers, such as PC Worx from Phönix.

In the PLC default setting, the PLC detects the interruption of the I/O connection to the device as a failure. The PLC considers three consecutive Real Time packets missing from the PLC or from the device as an interruption. According to the default setting, this leads to a system failure. To change this default setting, you employ Step7 programming measures.

Note: Monitoring the I/O connection to the CPU of the device as a failure can result in a system failure. Therefore, monitoring the I/O connection as a failure criterion is less suitable.

The I/O connection between the programmable logic controller (PLC) and the device can be interrupted by a management program. For example, a management station can saturate the CPU of the device with higher priority Real Time (RT) data. In this case, the device can still transmit or receive data packets and the system remains operational.

■ Providing the GDSML file

The Hirschmann device provides you with the following options for generating GDSML files and icons:

- ▶ You can use the graphical user interface in the *Advanced > Industrial Protocols > PROFINET* dialog to download the GSDML file and the icon of the device.

■ Incorporating the device in the configuration

- Open the *Simatic Manager* application from Simatic S7.
- Open your project.
- Go to the hardware configuration.
- Install the GSD(ML) file:

In the menu bar, click *Options > Install GSD File*.

Select the GSD file previously saved on your PC.

Simatic S7 installs the file together with the icon.

You will find the new device under:

PROFINET IO > Additional Field Devices > Switching Devices > Hirschmann..
or under

PROFINET IO > Additional Field Devices > Network Components > Hirschmann..

- Use the Drag-and-Drop function, pull the device onto the bus cable.

To rename the device, use the following steps:

- Highlight the device.
 - In the menu bar, click *PLC > Ethernet > Edit Ethernet Node*.
 - In the *Edit Ethernet Node* dialog, enter the name of the device in the *Assign device name* frame, *Device name* field.
 - Click the *Browse...* button.
 - Select the device.
 - Click the *OK* button.
 - Specify the name of the device.
 - Click the *Assign Name* button.
 - Click the *Close* button.
-
- In the hardware configuration, right-click the device and select *Object properties* from the drop-down list.
 - Enter the same name as specified in the *Edit Ethernet Node* dialog.
 - Click the *Ethernet* button.
 - Enter the IP parameters.
 - To close the *Properties - Ethernet interface...* window, click the *OK* button.
 - To close the *Properties* window, click the *OK* button.

The device is now included in the configuration.

Configuring IO Cycle

- In the hardware configuration, click the device.
- In the *Slot/Module View* dialog, right-click the X1 / PN-IO row.
- In the drop-down list, select *Object properties*.
- In the *Properties* window, open the *IO Cycle* tab.
- In the *Update Time* frame, *Update time[ms]:* field, select the required update time in ms, for the IO Cycle.
- In the *Watchdog Time* frame, *Number of accepted update cycles with missing IO data* field, select the required number for the IO Cycle.
- To close the *Properties* window, click the *OK* button.

Configuring Media Redundancy

- In the hardware configuration, left-click the device.
- In the *Slot/Module View* dialog, right-click the X1 / PN-IO row.
- In the drop-down list, select *Object properties*.
- In the *Properties* window, open the *Media Redundancy* tab.
- In the *MRP Configuration* frame, *Domain* field, select the required MRP domain for the node.
- In the *MRP Configuration* frame, *Role* field, select the required role of the node in the ring.
- In the *Ring Port 1* and *Ring Port 2* fields select the active MRP Ring Ports.
- To close the *Properties* window, click the *OK* button.

■ Adding modules for modular devices

- Use the Drag & Drop function to pull a module from the library into a slot.
 - Simatic S7 adds the ports using the Module properties.

■ Configuring device property

In slot 0 you enter the settings for the entire device.

- Select the device.
- Right-click slot 0.
 - To configure the entire device, select *Object properties*.
- In the *Properties* window, open the *Parameters* tab.

■ Configuring the port properties

For modular devices, slots 1 through n represent the modules. The ports are represented as subslots/submodules.

For non-Modular devices, the subslots 1 through n in slot 0 represent the ports.

Configuring Port Alarms

- Right-click a port, 1 through n, and select *Object properties*.
- In the *Properties* window, open the *Parameters* tab.
- Select the desired alarms and close the window.

Special case: "LinkDown" alarm:

The LinkDown alarm is made up of the AND-link

- of the Hirschmann-specific status for connection errors and
- of the Simatic S7-specific option for the connection.

Activating the LinkDown alarm:

- In the *Properties* dialog, open the *Parameters* tab (Hirschmann-specific).
- To enable the *Alarms* parameter, select the value *On* in the *Value* column.
- Enable the *Link state monitoring* parameter and select the *Generate diagnosis alarm when link goes down* option in the *Value* column.
- Open the *Options* tab.
- To activate link monitoring, select a fixed setting for the port in the *Connection* frame, *Transmission medium/duplex* field.

■ Configuring Connection Options

- Right-click a port, 1 through n, and select *Object properties*.
- In the *Properties* dialog, open the *Options* tab.
- In the *Connection* frame, *Transmission medium/duplex* field, select the desired setting for the port.
- To close the *Properties* window, click the *OK* button.

When you change the port setting to a value other than *Automatic settings*, the device disables the port for a short time. When the port is situated on the path between the I/O controller and the I/O device, the interruption can possibly lead to a failure in establishing the Application Relation. Make the following provisions before changing the port setting:

Note: Beware of Loops! Deactivate RSTP on the device ports between the I/O controller and the I/O device.

- Open the *Switching > L2-Redundancy > Spanning Tree > Spanning Tree Port* dialog, *CIST* tab.
- Unmark the *STP active* checkbox for the relevant ports.
- To save the changes temporarily, click the button.

Configuring Topology

- Right-click a port, 1 through n, and select *Object properties*.
- In the *Properties* dialog, open the *Topology* tab.
- In the *Partners* frame, *Partner port* field select the required setting for the partner port.
- To close the *Properties* window, click the *OK* button.

■ Swapping devices

Hirschmann devices support the device swapping function with an engineering station.

If identical devices are being swapped, the Network management station assigns the parameters of the original device to the new device.

The device swapping function with Simatic S7 requires the following prerequisites:

- ▶ S7 300 with SW release from V2.7 (currently available for CPU 319) or S7 400 with SW release from V5.2
- ▶ Hirschmann device SW release from 05.0.00
- ▶ Neighboring device(s) support(s) LLDP
- ▶ Topology (=neighborhood relationships) is configured and loaded onto SPS

Device swapping requires the following conditions:

- ▶ the replacement device is exactly the same type as the device to be replaced.
- ▶ the replacement device is connected to the exact same place in the network (same ports and neighboring devices).
- ▶ the replacement device has a *PROFINET* default configuration. Set the device name to "" (null string).

If these conditions are met, the Network management station automatically assigns the parameters of the original device (device name, IP parameters and configuration data) to the replacement device.

Procedure for swapping devices:

- System name "" (= null string)
 - IP address = 0.0.0.0 or DHCP
 - *PROFINET* activated
- Make a note of the port assignment on the original device and remove the original device from the system.
 - The PLC now detects an error.
- Now insert the replacement device in the same position in the network. Verify that the port assignments are the same as the original device.

The PLC finds the replacement device and configures it like the original device.

The PLC detects proper operation.

If necessary, reset the PLC to "Run".

■ Swapping modules

The *PROFINET* stack in the device detects a change in the connected modules and reports the change to the engineering station. If a previously configured module is removed from the device, the engineering station reports an error. If a configured module that was missing is connected, the Network management station removes the error message.

■ Topology Discovery

After the user initializes the Topology Discovery, the Network management station looks for connected devices.

■ **Configuring the topology**

Simatic S7 gives the user the option to configure the topology and monitor it accordingly.
Simatic S7 displays the connection parameters (quality and settings) in a colored graphic.

■ **Communication diagnosis**

Simatic S7 monitors the communication quality and outputs messages relating to communication problems.

■ **Outputting port statistics**

Simatic S7 counts for each port the number of data packets received and sent, the collisions, etc.
You can view these figures in the form of statistic tables in Simatic S7.

15.4.2 PROFINET Parameter

■ Alarms

The device supports alarms on the device and port levels.

| | |
|------------------------|--|
| Alarms on device level | Change in device status Failure of redundant power supply Failure/removal of ACA |
| Alarms on port level | Change in link status Specified transfer rate exceeded. |

Table 37: Alarms supported

■ Record parameters

The device provides records for:

- ▶ Device parameters
- ▶ Device status
- ▶ Port status/parameters

| Byte | Content | Access | Value | Meaning |
|------|------------------------------|--------|-------|--|
| 0 | Send alarm if status changes | rw | 0 | Do not send alarm |
| | | | 1 | Send alarm if one of the following alarm reasons occurs. |
| 1 | Power Alarm | rw | 0 | Do not send alarm |
| | | | 1 | Send alarm if a power supply fails. |
| 2 | ACA Alarm | rw | 0 | Do not send alarm |
| | | | 1 | Send alarm if the ACA is removed. |
| 3 | Module Alarm | rw | 0 | Do not send alarm |
| | | | 1 | Send alarm if the module connections are changed. |

Table 38: Device parameters

| Byte | Content | Access | Value | Meaning |
|------|---------------------|--------|-------|-------------|
| 0 | Device status | ro | 0 | Unavailable |
| | | | 1 | OK |
| | | | 2 | Error |
| 1 | Power supply unit 1 | ro | 0 | Unavailable |
| | | | 1 | OK |
| | | | 2 | Error |
| 2 | Power supply unit 2 | ro | 0 | Unavailable |
| | | | 1 | OK |
| | | | 2 | Error |
| 3 | Power supply unit 3 | ro | 0 | Unavailable |
| | | | 1 | OK |
| | | | 2 | Error |
| 4 | Power supply unit 4 | ro | 0 | Unavailable |
| | | | 1 | OK |
| | | | 2 | Error |
| 5 | Power supply unit 5 | ro | 0 | Unavailable |
| | | | 1 | OK |
| | | | 2 | Error |
| 6 | Power supply unit 6 | ro | 0 | Unavailable |
| | | | 1 | OK |
| | | | 2 | Error |

Table 39: Device status

| Byte | Content | Access | Value | Meaning |
|------|---------------------|--------|-------|---|
| 7 | Power supply unit 7 | ro | 0 | Unavailable |
| | | | 1 | OK |
| | | | 2 | Error |
| 8 | Power supply unit 8 | ro | 0 | Unavailable |
| | | | 1 | OK |
| | | | 2 | Error |
| 9 | Signal contact 1 | ro | 0 | Unavailable |
| | | | 1 | Closed |
| | | | 2 | Open |
| 10 | Signal contact 2 | ro | 0 | Unavailable |
| | | | 1 | Closed |
| | | | 2 | Open |
| 11 | Temperature | ro | 0 | Unavailable |
| | | | 1 | OK |
| | | | 2 | Threshold value for temperature exceeded or not reached |
| 12 | Fan | ro | 0 | Unavailable |
| | | | 1 | OK |
| | | | 2 | Fan failure |
| 13 | Module removal | ro | 0 | Unavailable |
| | | | 1 | OK |
| | | | 2 | A module has been removed. |
| 14 | ACA Removed | ro | 0 | Unavailable |
| | | | 1 | OK |
| | | | 2 | The ACA has been removed. |
| 15 | Not used | | 0 | |
| | | | 1 | |
| | | | 2 | |
| 16 | Not used | | 0 | |
| | | | 1 | |
| | | | 2 | |
| 17 | Connection | ro | 0 | Unavailable |
| | | | 1 | OK |
| | | | 2 | Connection failure. |

Table 39: Device status

| Byte | Content | Access | Value | Meaning |
|------|----------------------------|--------|-------|--|
| 0 | Report port error | rw | 0 | Do not send alarm |
| | | | 1 | Send alarm if one of the following alarm reasons occurs. |
| 1 | Report connection error | rw | 0 | Do not send alarm |
| | | | 1 | Send alarm if the connection has failed. |
| 2 | Transmission rate too high | rw | 0 | Do not send alarm |
| | | | 1 | Send alarm if the threshold value for the temperature has been exceeded. |
| 3 | Port on | rw | 0 | Unavailable |
| | | | 1 | Switched on |
| | | | 2 | Switched off |
| 4 | Link status | ro | 0 | Unavailable |
| | | | 1 | Connection exists |
| | | | 2 | Connection interrupted |
| 5 | Bit rate | ro | 0 | Unavailable |
| | | | 1 | Unknown |
| | | | 2 | 10 MBit/s |
| | | | 2 | 100 MBit/s |
| | | | 2 | 1000 MBit/s |
| 6 | Duplex | ro | 0 | Half duplex |
| | | | 1 | Full duplex |
| | | | 2 | Full duplex |
| 7 | Autonegotiation | ro | 0 | Unavailable |
| | | | 1 | off |
| | | | 2 | on |

Table 40: Port status/parameters

I/O Data

You will find the bit assignment for the transferred I/O data in the following table.

| Direction | Byte | Bit | Meaning |
|-----------|------|---------------------|-----------------------|
| Input | 0 | | General |
| | | 0 | Device status |
| | | 1 | Signal contact 1 |
| | | 2 | Signal contact 2 |
| | | 3 | Temperature |
| | | 4 | Fan |
| | | 5 | Module removal |
| | | 6 | ACA Removed |
| | 7 | Not used | |
| Input | 1 | | Power supply status |
| | | 0 | Power supply unit 1 |
| | | 1 | Power supply unit 2 |
| | | 2 | Power supply unit 3 |
| | | 3 | Power supply unit 4 |
| | | 4 | Power supply unit 5 |
| | | 5 | Power supply unit 6 |
| | | 6 | Power supply unit 7 |
| | 7 | Power supply unit 8 | |
| Input | 2 | | Supply voltage status |
| | | 0 | Not used |
| | | 1 | Not used |
| | | 2 | Connection error |
| | | 3 | Not used |
| | | 4 | Not used |
| | | 5 | Not used |
| | | 6 | Not used |
| | 7 | Not used | |
| Output | | | Not defined |

Meaning of the bit content:
0: OK or unavailable
1: Reason for report exists

Table 41: Device I/O data

| Direction | Byte | Bit | Meaning |
|-----------|------|---------|-------------------------------------|
| Input | 0 | | Connection status for ports 1 to 8 |
| | | 0 | Port 1 |
| | | 1 | Port 2 |
| | | 2 | Port 3 |
| | | 3 | Port 4 |
| | | 4 | Port 5 |
| | | 5 | Port 6 |
| | | 6 | Port 7 |
| | 7 | Port 8 | |
| Input | 1 | | Connection status for ports 9 to 16 |
| | | 0 | Port 9 |
| | | 1 | Port 10 |
| | | 2 | Port 11 |
| | | 3 | Port 12 |
| | | 4 | Port 13 |
| | | 5 | Port 14 |
| | | 6 | Port 15 |
| | 7 | Port 16 | |

Table 42: Port I/O data

| Direction | Byte | Bit | Meaning |
|-------------------------------|------|------------------------------|---|
| Input | n | | Connection for port $(n * 8) + 1$ to port $(n * 8) + 8$ |
| | | 0 | Port $(n * 8) + 1$ |
| | | 1 | Port $(n * 8) + 2$ |
| | | 2 | Port $(n * 8) + 3$ |
| | | 3 | Port $(n * 8) + 4$ |
| | | 4 | Port $(n * 8) + 5$ |
| | | 5 | Port $(n * 8) + 6$ |
| | | 6 | Port $(n * 8) + 7$ |
| | 7 | Port $(n * 8) + 8$ | |
| Means the Input Bit contains: | | | |
| – 0: no connection | | | |
| – 1: active connection | | | |
| Output | 0 | | "Port activated" for ports 1 to 8 |
| | | 0 | Port 1 activated |
| | | 1 | Port 2 activated |
| | | 2 | Port 3 activated |
| | | 3 | Port 4 activated |
| | | 4 | Port 5 activated |
| | | 5 | Port 6 activated |
| | | 6 | Port 7 activated |
| | 7 | Port 8 activated | |
| Output | 1 | | "Port activated" for ports 9 to 16 |
| | | 0 | Port 9 activated |
| | | 1 | Port 10 activated |
| | | 2 | Port 11 activated |
| | | 3 | Port 12 activated |
| | | 4 | Port 13 activated |
| | | 5 | Port 14 activated |
| | | 6 | Port 15 activated |
| | 7 | Port 16 activated | |
| Output | n | | "Port activated" for port $(n * 8) + 1$ to port $(n * 8) + 8$ |
| | | 0 | Port $(n * 8) + 1$ activated |
| | | 1 | Port $(n * 8) + 2$ activated |
| | | 2 | Port $(n * 8) + 3$ activated |
| | | 3 | Port $(n * 8) + 4$ activated |
| | | 4 | Port $(n * 8) + 5$ activated |
| | | 5 | Port $(n * 8) + 6$ activated |
| | | 6 | Port $(n * 8) + 7$ activated |
| | 7 | Port $(n * 8) + 8$ activated | |

Means the Output Bit contains:

- 0: no port active
- 1: active active

Table 42: Port I/O data

A Setting up the configuration environment

A.1 Setting up a DHCP/BOOTP server

The following example describes the configuration of a DHCP server using the haneWIN DHCP Server software. This shareware software is a product of IT-Consulting Dr. Herbert Hanewinkel. You can download the software from <https://www.hanewin.net>. You can test the software for 30 calendar days from the date of the first installation, and then decide whether you want to purchase a license.

To install the DHCP servers on your PC put the product CD in the CD drive of your PC and under Additional Software select *haneWIN DHCP-Server*. To carry out the installation, follow the installation assistant.

Start the *haneWIN DHCP-Server* program.



Figure 65: Start window of the *haneWIN DHCP-Server* program

Note: The installation procedure includes a service that is automatically started in the basic configuration when Windows is activated. This service is also active if the program itself has not been started. When started, the service responds to DHCP queries.

- Open the window for the program settings in the menu *Options > Preferences* and select the *DHCP* tab.
- Specify the settings displayed in the figure.
- Click the *OK* button.

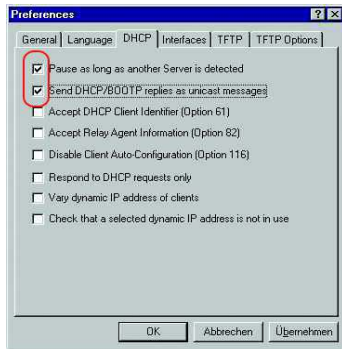

Figure 66: DHCP setting

- To enter the configuration profiles, select *Options > Configuration Profiles* in the menu bar.
- Specify the name for the new configuration profile.
- Click the *Add* button.

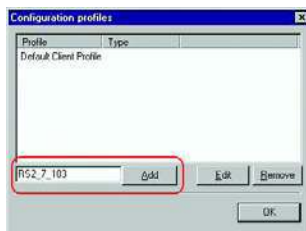

Figure 67: Adding configuration profiles

- Specify the netmask.
- Click the *Apply* button.

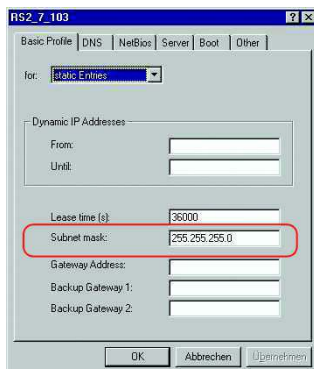

Figure 68: Netmask in the configuration profile

- Select the *Boot* tab.
- Enter the IP address of your tftp server.

Setting up the configuration environment

A.1 Setting up a DHCP/BOOTP server

- Enter the path and the file name for the configuration file.
- Click the **Apply** button and then the **OK** button.

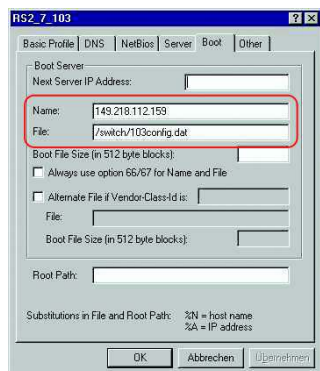

Figure 69: Configuration file on the tftp server

- Add a profile for each device type.
If devices of the same type have different configurations, then you add a profile for each configuration.
- To complete the addition of the configuration profiles, click the **OK** button.

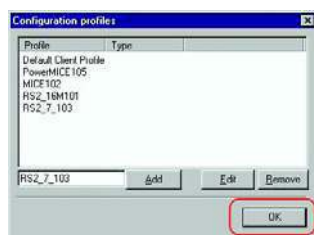

Figure 70: Managing configuration profiles

- To enter the static addresses, in the main window, click the **Static** button.



Figure 71: Static address input

- Click the **Add** button.

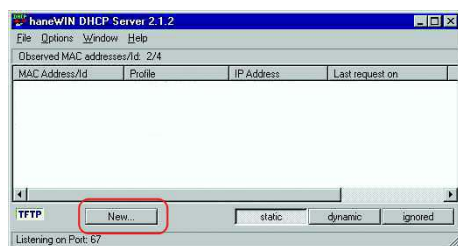

Figure 72: Adding static addresses

- Enter the MAC address of the device.
- Enter the IP address of the device.

- Select the configuration profile of the device.
- Click the **Apply** button and then the **OK** button.

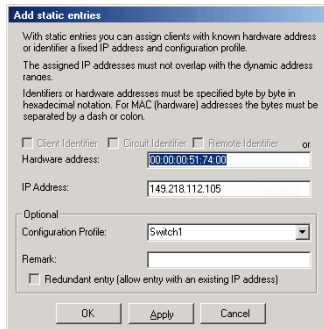

Figure 73: Entries for static addresses

- Add an entry for each device that will get its parameters from the DHCP server.

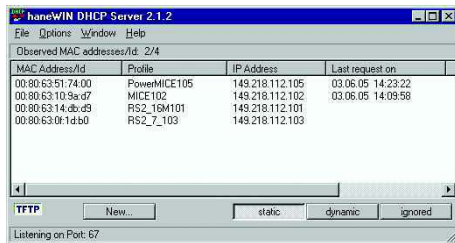

Figure 74: DHCP server with entries

A.2 Setting up a DHCP server with Option 82

The following example describes the configuration of a DHCP server using the haneWIN DHCP Server software. This shareware software is a product of IT-Consulting Dr. Herbert Hanewinkel. You can download the software from <https://www.hanewin.net>. You can test the software for 30 calendar days from the date of the first installation, and then decide whether you want to purchase a license.

- To install the DHCP servers on your PC put the product CD in the CD drive of your PC and under Additional Software select *haneWIN DHCP-Server*. To carry out the installation, follow the installation assistant.
- Start the *haneWIN DHCP-Server* program.



Figure 75: Start window of the *haneWIN DHCP-Server* program

Note: The installation procedure includes a service that is automatically started in the basic configuration when Windows is activated. This service is also active if the program itself has not been started. When started, the service responds to DHCP queries.

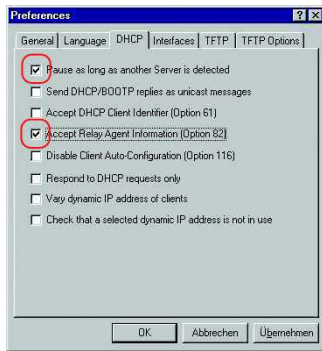

Figure 76: DHCP setting

- To enter the static addresses, click the *Add* button.

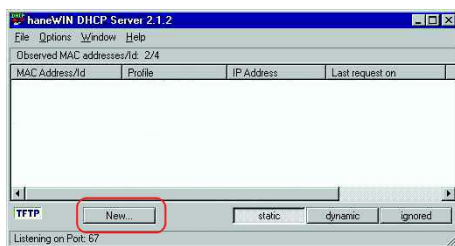

Figure 77: Adding static addresses

- Mark the *Circuit Identifier* checkbox.
- Mark the *Remote Identifier* checkbox.

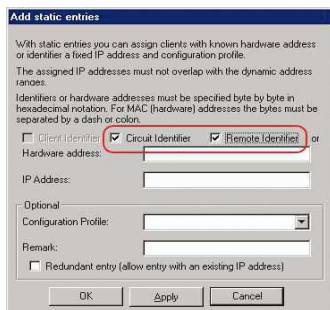

Figure 78: Default setting for the fixed address assignment

- In the *Hardware address* field, specify the value *Circuit Identifier* and the value *Remote Identifier* for the switch and port.
 The DHCP server assigns the IP address specified in the *IP address* field to the device that you connect to the port specified in the *Hardware address* field.

The hardware address is in the following form:

ci cl hh vvvv ssmpprirlxxxxxxxxxxxx

- ▶ ci
Sub-identifier for the type of the Circuit ID
- ▶ cl
Length of the Circuit ID.
- ▶ hh
Hirschmann identifier:
01 if a Hirschmann device is connected to the port, otherwise 00.
- ▶ vvvv
VLAN ID of the DHCP request.
Default setting: 0001 = VLAN 1

Setting up the configuration environment

A.2 Setting up a DHCP server with Option 82

- ▶ `ss`
Socket of device at which the module with that port is located to which the device is connected. Specify the value `00`.
- ▶ `mm`
Module with the port to which the device is connected.
- ▶ `pp`
Port to which the device is connected.
- ▶ `ri`
Sub-identifier for the type of the Remote ID
- ▶ `rl`
Length of the Remote ID.
- ▶ `xxxxxxxxxxxx`
Remote ID of the device (for example MAC address) to which a device is connected.

Add static entries

With static entries you can assign clients with known hardware address or identifier a fixed IP address and configuration profile.

The assigned IP addresses must not overlap with the dynamic address ranges.

Identifiers or hardware addresses must be specified byte by byte in hexadecimal notation. For MAC (hardware) addresses the bytes must be separated by a dash or colon.

Client Identifier Circuit Identifier Remote Identifier or

Hardware address:

IP Address:

Optional:

Configuration Profile:

Remark:

Redundant entry (allow entry with an existing IP address)

OK Apply Cancel

Figure 79: Specifying the addresses

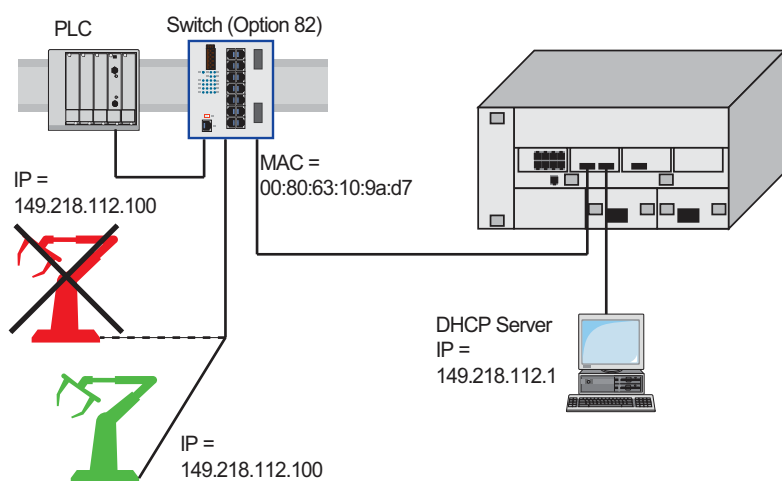

Figure 80: Application example of using Option 82

A.3 Preparing access via SSH

To access the device using SSH, perform the following steps:

- ▶ Generate a key on the device.
or
- ▶ Upload your own key on the device.
- ▶ Prepare access to the device in the SSH client program.

Note: In the default setting, the key is already existing and access using SSH is enabled.

A.3.1 Generating a key on the device

The device allows you to generate the key directly on the device.

Perform the following steps:

- Open the *Device Security > Management Access > Server* dialog, *SSH* tab.
- Disable the SSH server.
To disable the function, select the *Off* radio button in the *Operation* frame.
- To save the changes temporarily, click the button.
- To create a DSA key or a RSA key, in the *Signature* frame, click the *Create* button.
- Enable the SSH server.
To enable the function, select the *On* radio button in the *Operation* frame.
- To save the changes temporarily, click the button.

```
enable  
configure  
ssh key dsa generate
```

```
Change to the Privileged EXEC mode.  
Change to the Configuration mode.  
Generate a new DSA key.
```

A.3.2 Loading your own key onto the device

OpenSSH gives experienced network administrators the option of generating an own key. To generate the key, enter the following commands on your PC:

```
ssh-keygen(.exe) -q -t rsa1 -f rsa1.key -C '' -N ''  
dsaparam -out dsaparam.pem 1024
```

The device allows you to upload the own SSH key to the device.

Perform the following steps:

- Open the *Device Security > Management Access > Server* dialog, *SSH* tab.
 - Disable the SSH server.
To disable the function, select the *Off* radio button in the *Operation* frame.
 - To save the changes temporarily, click the button.
 - If the host key is located on your PC or on a network drive, drag and drop the file that contains the key in the  area. Alternatively click in the area to select the file.
 - Click the *Start* button in the *Key import* frame to load the key onto the device.
 - Enable the SSH server.
To enable the function, select the *On* radio button in the *Operation* frame.
 - To save the changes temporarily, click the button.
-
- Copy the self-generated key from your PC to the external memory.
 - Copy the key from the external memory into the device.

enable

copy sshkey envm <file name>

Change to the Privileged EXEC mode.

Load your own key onto the device from the external memory.

A.3.3 Preparing the SSH client program

The *PuTTY* program allows you to access the device using SSH. This program is provided on the product CD.

Perform the following steps:

- Start the program by double-clicking on it.

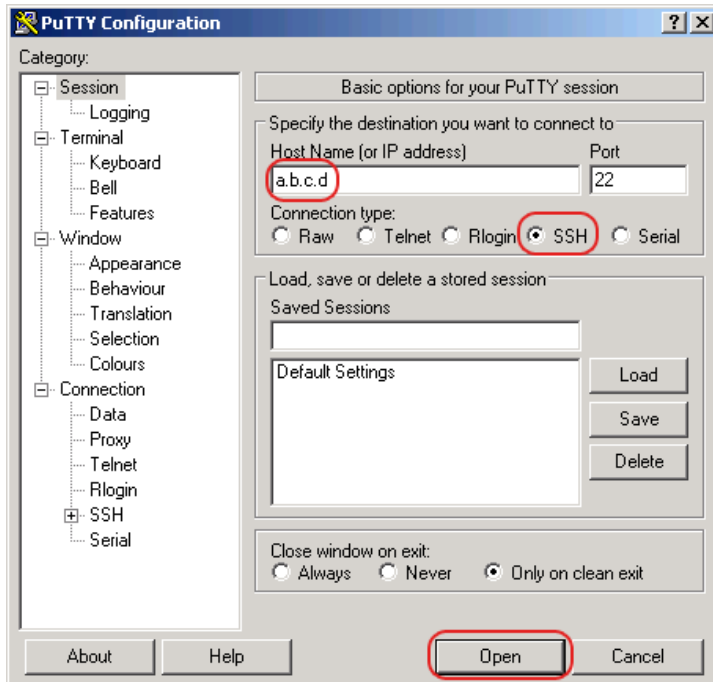

Figure 81: PuTTY input screen

- In the *Host Name (or IP address)* field you enter the IP address of your device. The IP address (a.b.c.d) consists of 4 decimal numbers with values from 0 to 255. The 4 decimal numbers are separated by points.
- To select the connection type, select the *SSH* radio button in the *Connection type* range.
- Click the *Open* button to set up the data connection to your device.

Just before the connection is established, the *PuTTY* program displays a security alarm message and gives you the option of checking the key fingerprint.



Figure 82: Security alert prompt for the fingerprint

- Check the fingerprint of the key to ensure that you have actually connected to the desired device.
- If the fingerprint matches your key, click the *Yes* button.

The *PuTTY* program also displays another security alarm message at the specified warning threshold.

For experienced network administrators, another way of accessing your device through an SSH is by using the OpenSSH Suite. To set up the data connection, enter the following command:

```
ssh admin@10.0.112.53
```

`admin` is the user name.

`10.0.112.53` is the IP address of your device.

A.4 HTTPS certificate

Your web browser establishes the connection to the device using the HTTPS protocol. The prerequisite is that you enable the *HTTPS server* function in the *Device Security > Management Access > Server* dialog, *HTTPS* tab.

Note: Third-party software such as web browsers validate certificates based on criteria such as their expiration date and current cryptographic parameter recommendations. Old certificates can cause errors, for example, when they expire or cryptographic recommendations change. Upload your own, up-to-date certificate or regenerate the certificate with the latest firmware to solve validation conflicts with third-party software.

A.4.1 HTTPS certificate management

A standard certificate according to X.509/PEM (Public Key Infrastructure) is required for encryption. In the default setting, a self-generated certificate is already present on the device.

- Open the *Device Security > Management Access > Server* dialog, *HTTPS* tab.
- To create a X509/PEM certificate, in the *Certificate* frame, click the *Create* button.
- To save the changes temporarily, click the button.
- Restart the HTTPS server to activate the key. Restart the server using the Command Line Interface (CLI).

```
enable
configure
https certificate generate
no https server
https server
```

Change to the Privileged EXEC mode.
Change to the Configuration mode.
Generate a https X.509/PEM Certificate.
Disable the *HTTPS* function.
Enable the *HTTPS* function.

- The device enables you also to upload an externally generated X.509/PEM Standard certificate to the device:

- Open the *Device Security > Management Access > Server* dialog, *HTTPS* tab.
- If the certificate is located on your PC or on a network drive, drag and drop the certificate in the  area. Alternatively click in the area to select the certificate.
- Click on the *Start* button to copy the certificate to the device.
- To save the changes temporarily, click the button.

```
enable
copy httpscert envm <file name>

configure
no https server
https server
```

Change to the Privileged EXEC mode.
Copy HTTPS certificate from external non-volatile memory device.
Change to the Configuration mode.
Disable the *HTTPS* function.
Enable the *HTTPS* function.

Note: If you upload or create a certificate, be sure to reboot the device or the HTTPS server in order to activate the certificate. Restart the server using the Command Line Interface (CLI).

A.4.2 Access through HTTPS

The default setting for HTTPS data connection is TCP port 443. If you change the number of the HTTPS port, reboot the device or the HTTPS server. Thus the change becomes effective.

Perform the following steps:

- Open the *Device Security > Management Access > Server* dialog, *HTTPS* tab.
- To enable the function, select the *On* radio button in the *Operation* frame.
- To access the device by HTTPS, enter HTTPS instead of HTTP in your browser, followed by the IP address of the device.

```
enable  
configure  
https port 443
```

```
https server  
show https
```

Change to the Privileged EXEC mode.

Change to the Configuration mode.

Specifies the number of the TCP port on which the web server receives HTTPS requests from clients.

Enable the *HTTPS* function.

Displays the status of the *HTTPS* server and the port number.

If you make changes to the HTTPS port number, disable the HTTPS server and then enable it again in order to make the changes effective.

The device uses HTTPS protocol and establishes a new data connection. At the end of the session, when the user logs out, the device terminates the data connection.

B Appendix

B.1 Literature references

- ▶ “Optische Übertragungstechnik in industrieller Praxis”
Christoph Wrobel (ed.)
Hüthig Buch Verlag Heidelberg
ISBN 3-7785-2262-0
- ▶ Hirschmann Manual
“Basics of Industrial ETHERNET and TCP/IP”
280 710-834
- ▶ “TCP/IP Illustrated”, Vol. 1
W.R. Stevens
Addison Wesley 1994
ISBN 0-201-63346-9

B.2 Maintenance

Hirschmann is continually working on improving and developing their software. Check regularly whether there is an updated version of the software that provides you with additional benefits. You find information and software downloads on the Hirschmann product pages on the Internet (www.hirschmann.com).

B.3 Management Information Base (MIB)

The Management Information Base (MIB) is designed in the form of an abstract tree structure.

The branching points are the object classes. The "leaves" of the MIB are called generic object classes.

If this is required for unique identification, the generic object classes are instantiated, that means the abstract structure is mapped onto reality, by specifying the port or the source address.

Values (integers, time ticks, counters or octet strings) are assigned to these instances; these values can be read and, in some cases, modified. The object description or object ID (OID) identifies the object class. The subidentifier (SID) is used to instantiate them.

Example:

The generic object class `hm2PSState` (OID = 1.3.6.1.4.1.248.11.11.1.1.1.1.2) is the description of the abstract information `power supply status`. However, it is not possible to read any value from this, as the system does not know which power supply is meant.

Specifying the subidentifier 2 maps this abstract information onto reality (instantiates it), thus identifying it as the operating status of power supply 2. A value is assigned to this instance and can be read. The instance `get 1.3.6.1.4.1.248.11.11.1.1.1.1.2.1` returns the response 1, which means that the power supply is ready for operation.

Definition of the syntax terms used:

| | |
|-------------------|---|
| Integer | An integer in the range $-2^{31} - 2^{31}-1$ |
| IP address | xxx.xxx.xxx.xxx (xxx = integer in the range 0..255) |
| MAC address | 12-digit hexadecimal number in accordance with ISO/IEC 8802-3 |
| Object Identifier | x.x.x.x... (for example 1.3.6.1.4.1.248...) |
| Octet String | ASCII character string |
| PSID | Power supply identifier (number of the power supply unit) |
| TimeTicks | Stopwatch, Elapsed time = numerical value / 100 (in seconds) numerical value = integer in the range $0-2^{32}-1$ |
| Timeout | Time value in hundredths of a second time value = integer in the range $0-2^{32}-1$ |
| Type field | 4-digit hexadecimal number in accordance with ISO/IEC 8802-3 |
| Counter | Integer ($0-2^{32}-1$), whose value is increased by 1 when certain events occur. |

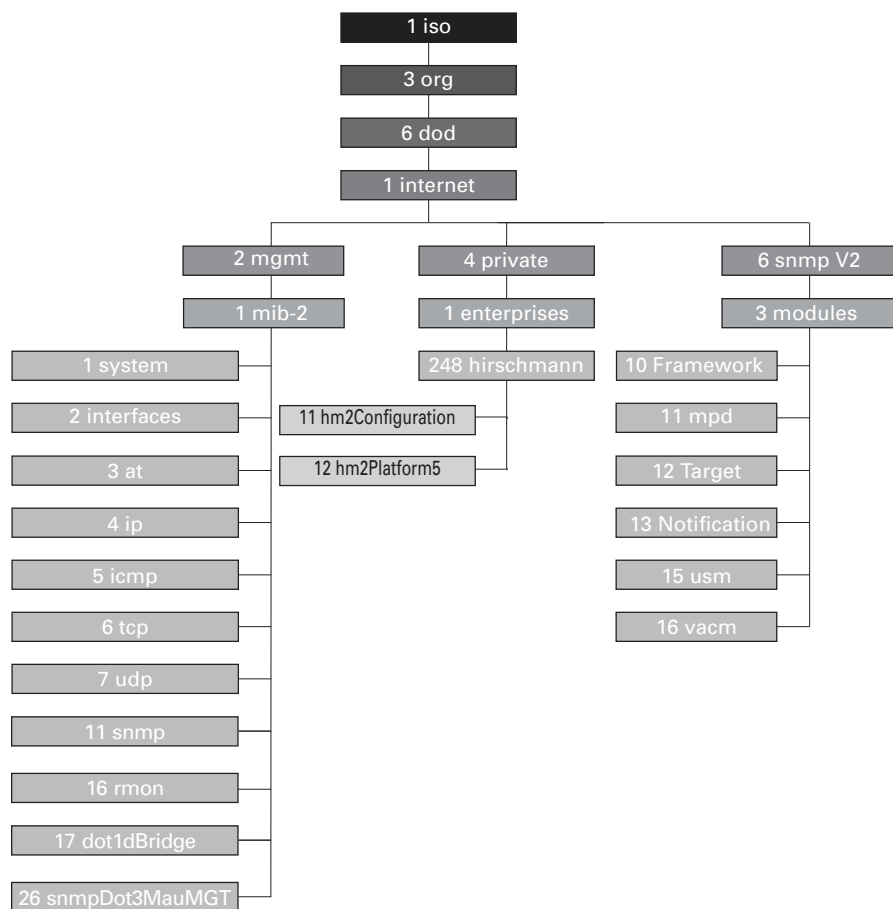

Figure 83: Tree structure of the Hirschmann MIB

A description of the MIB can be found on the product CD provided with the device.

B.4 List of RFCs

| | |
|----------|---|
| RFC 768 | UDP |
| RFC 783 | TFTP |
| RFC 791 | IP |
| RFC 792 | ICMP |
| RFC 793 | TCP |
| RFC 826 | ARP |
| RFC 854 | Telnet |
| RFC 855 | Telnet Option |
| RFC 951 | BOOTP |
| RFC 1112 | IGMPv1 |
| RFC 1157 | SNMPv1 |
| RFC 1155 | SMIv1 |
| RFC 1212 | Concise MIB Definitions |
| RFC 1213 | MIB2 |
| RFC 1493 | Dot1d |
| RFC 1542 | BOOTP-Extensions |
| RFC 1643 | Ethernet-like -MIB |
| RFC 1757 | RMON |
| RFC 1867 | Form-Based File Upload in HTML |
| RFC 1901 | Community based SNMP v2 |
| RFC 1905 | Protocol Operations for SNMP v2 |
| RFC 1906 | Transport Mappings for SNMP v2 |
| RFC 1945 | HTTP/1.0 |
| RFC 2068 | HTTP/1.1 protocol as updated by draft-ietf-http-v11-spec-rev-03 |
| RFC 2131 | DHCP |
| RFC 2132 | DHCP-Options |
| RFC 2233 | The Interfaces Group MIB using SMI v2 |
| RFC 2236 | IGMPv2 |
| RFC 2246 | The TLS Protocol, Version 1.0 |
| RFC 2346 | AES Ciphersuites for Transport Layer Security |
| RFC 2365 | Administratively Scoped IP Multicast |
| RFC 2578 | SMIv2 |
| RFC 2579 | Textual Conventions for SMI v2 |
| RFC 2580 | Conformance statements for SMI v2 |
| RFC 2613 | SMON |
| RFC 2618 | RADIUS Authentication Client MIB |
| RFC 2620 | RADIUS Accounting MIB |
| RFC 2674 | Dot1p/Q |
| RFC 2818 | HTTP over TLS |
| RFC 2851 | Internet Addresses MIB |
| RFC 2863 | The Interfaces Group MIB |
| RFC 2865 | RADIUS Client |
| RFC 2866 | RADIUS Accounting |
| RFC 2868 | RADIUS Attributes for Tunnel Protocol Support |
| RFC 2869 | RADIUS Extensions |

| | |
|-------------|---|
| RFC 2869bis | RADIUS support for EAP |
| RFC 2933 | IGMP MIB |
| RFC 3164 | The BSD Syslog Protocol |
| RFC 3376 | IGMPv3 |
| RFC 3410 | Introduction and Applicability Statements for Internet Standard Management Framework |
| RFC 3411 | An Architecture for Describing Simple Network Management Protocol (SNMP) Management Frameworks |
| RFC 3412 | Message Processing and Dispatching for the Simple Network Management Protocol (SNMP) |
| RFC 3413 | Simple Network Management Protocol (SNMP) Applications |
| RFC 3414 | User-based Security Model (USM) for version 3 of the Simple Network Management Protocol (SNMPv3) |
| RFC 3415 | View-based Access Control Model (VACM) for the Simple Network Management Protocol (SNMP) |
| RFC 3418 | Management Information Base (MIB) for the Simple Network Management Protocol (SNMP) |
| RFC 3580 | 802.1X RADIUS Usage Guidelines |
| RFC 3584 | Coexistence between Version 1, Version 2, and Version 3 of the Internet-standard Network Management Framework |
| RFC 4022 | Management Information Base for the Transmission Control Protocol (TCP) |
| RFC 4113 | Management Information Base for the User Datagram Protocol (UDP) |
| RFC 4188 | Definitions of Managed Objects for Bridges |
| RFC 4251 | SSH protocol architecture |
| RFC 4252 | SSH authentication protocol |
| RFC 4253 | SSH transport layer protocol |
| RFC 4254 | SSH connection protocol |
| RFC 4293 | Management Information Base for the Internet Protocol (IP) |
| RFC 4318 | Definitions of Managed Objects for Bridges with Rapid Spanning Tree Protocol |
| RFC 4330 | Simple Network Time Protocol (SNTP) Version 4 for IPv4, IPv6 and OSI |
| RFC 4363 | Definitions of Managed Objects for Bridges with Traffic Classes, Multicast Filtering, and Virtual LAN Extensions |
| RFC 4541 | Considerations for Internet Group Management Protocol (IGMP) and Multicast Listener Discovery (MLD) Snooping Switches |
| RFC 4836 | Definitions of Managed Objects for IEEE 802.3 Medium Attachment Units (MAUs) |

B.5 Underlying IEEE Standards

| | |
|--------------|---|
| IEEE 802.1AB | Station and Media Access Control Connectivity Discovery |
| IEEE 802.1D | MAC Bridges (switching function) |
| IEEE 802.1Q | Virtual LANs (VLANs, MRP, Spanning Tree) |
| IEEE 802.1X | Port Authentication |
| IEEE 802.3 | Ethernet |
| IEEE 802.3ac | VLAN Tagging |
| IEEE 802.3x | Flow Control |
| IEEE 802.3af | Power over Ethernet |

B.6 Underlying IEC Norms

| | |
|-----------|--|
| IEC 62439 | High availability automation networks HSR – High-availability Seamless Redundancy MRP – Media Redundancy Protocol based on a ring topology PRP – Parallel Redundancy Protocol |
|-----------|--|

B.7 Underlying ANSI Norms

ANSI/TIA-1057 Link Layer Discovery Protocol for Media Endpoint Devices, April 2006

B.8 Technical Data

| Switching | |
|---|--|
| Size of the MAC address table (incl. static filters) | 2048 |
| Max. number of statically configured MAC address filters | 100 |
| Max. number of MAC address filters learnable through IGMP Snooping | 256 |
| Max. number of MAC address entries (MMRP) | 64 |
| Number of priority queues | 4 Queues |
| Port priorities that can be set | 0..3 |
| VLAN | |
| VLAN ID range | 1..4042 |
| Number of VLANs | max. 16 simultaneously per device max. 16 simultaneously per port |

B.9 Copyright of integrated Software

The product contains, among other things, Open Source Software files developed by third parties and licensed under an Open Source Software license.

You can find the license terms in the graphical user interface in the *Help > Licenses* dialog.

B.10 Abbreviations used

| | |
|-------|---|
| ACA | AutoConfiguration Adapter |
| ACL | Access Control List |
| BOOTP | Bootstrap Protocol |
| CLI | Command Line Interface |
| DHCP | Dynamic Host Configuration Protocol |
| FDB | Forwarding Database |
| GUI | Graphical User Interface |
| HTTP | Hypertext Transfer Protocol |
| HTTPS | Hypertext Transfer Protocol Secure |
| ICMP | Internet Control Message Protocol |
| IEEE | Institute of Electrical and Electronics Engineers |
| IGMP | Internet Group Management Protocol |
| IP | Internet Protocol |
| LED | Light Emitting Diode |
| LLDP | Link Layer Discovery Protocol |
| MAC | Media Access Control |
| MIB | Management Information Base |
| MRP | Media Redundancy Protocol |
| MSTP | Multiple Spanning Tree Protocol |
| NMS | Network Management System |
| NTP | Network Time Protocol |
| PC | Personal Computer |
| PTP | Precision Time Protocol |
| QoS | Quality of Service |
| RFC | Request For Comment |
| RM | Redundancy Manager |
| RSTP | Rapid Spanning Tree Protocol |
| SCP | Secure Copy |
| SFP | Small Form-factor Pluggable |
| SFTP | SSH File Transfer Protocol |
| SNMP | Simple Network Management Protocol |
| SNTP | Simple Network Time Protocol |
| TCP | Transmission Control Protocol |
| TFTP | Trivial File Transfer Protocol |
| TP | Twisted Pair |
| UDP | User Datagram Protocol |
| URL | Uniform Resource Locator |
| UTC | Coordinated Universal Time |
| VLAN | Virtual Local Area Network |

C Index

1

802.1X 44

A

Access roles 47
 Access security 76
 ACA 58, 264, 264, 295
 Advanced Mode 145, 147
 Aging time 107
 Alarm 196, 264
 Alarm messages 194
 Alarm setting 258
 Alternate port 178, 184
 APNIC 30
 ARIN 30
 ARP 32
 Authentication list 44
 Automatic configuration 77

B

Backup port 178, 184
 Bandwidth 122
 Best Master Clock algorithm 99
 Boundary clock (PTP) 98
 BOOTP 29
 BPDU 173
 BPDU guard 183, 184
 Bridge Identifier 170
 Bridge Protocol Data Unit 173

C

CD-ROM 270, 274
 CIDR 33
 CIP 244
 Classless inter domain routing 33
 Closed circuit 203
 Command line interface 19
 Common Industrial Protocol 244
 Compatibility (STP) 181
 Configuration file 40
 Configuration modifications 194
 Conformity class 256

D

Data traffic 89
 Daylight saving time 93
 DAN 159
 Delay measurement (PTP) 100
 Delay time (MRP) 145
 Delay (PTP) 100
 Denial of service 90
 Denial of Service 89
 Designated bridge 178
 Designated port 178, 183
 Destination table 194
 Device description language 256
 Device Level Ring 150
 Device status 197
 DHCP 29
 DHCP server 92, 95, 270, 274

Diameter (Spanning Tree) 172
 DiffServ 113
 Disabled port 178
 DLR - EtherNet/IP compatibility 156
 DoS 89, 90
 DSCP 113, 120

E

Edge port 178, 183
 EDS 245, 245
 Engineering system 259
 Engineering Station 262
 EtherNet/IP website 244
 Event log 218

F

Fast\ MRP 142, 142, 145, 147, 222
 FAQ 301
 First installation 29
 Flow control 122

G

Gateway 31, 35
 Generic Ethernet Module 245
 Generic object classes 286
 Grandmaster (PTP) 99
 GSD 258, 259
 GSDML 256
 GSD file 259

H

HaneWin 270, 274
 Hardware reset 194
 HiDiscovery 29, 34, 36, 38, 79, 84, 200, 219, 243
 Host address 31
 HSR 141, 142, 162
 HSR and PRP network connections 165
 HSR network structure 163

I

IANA 30
 IAS 44
 Icon 258
 IEC 61850 236
 IEEE 802.1X 44
 IEEE MAC Adresse 212
 IGMP snooping 107, 107, 244
 Industrial HiVision 11, 40, 53
 Instantiation 286
 Integrated authentication server 44
 IP address 30, 35, 40
 IP header 113, 116
 ISO/OSI layer model 32

L

LACNIC 30
 Leave message 107
 Link Aggration 142
 Link monitoring 197, 203
 Login page 18

| | | | |
|---------------------------------------|--------------------|--|--|
| Loop guard | 184, 185 | | |
| LRE functionality | 158 | | |
| M | | | |
| MaxAge | 172 | | |
| MAC address filter | 104 | | |
| MAC destination address | 32 | | |
| Memory (RAM) | 57 | | |
| Message | 194 | | |
| MMS | 236 | | |
| Mode | 77 | | |
| Module properties | 260 | | |
| MRP | 141, 142, 144, 145 | | |
| Multicast | 107 | | |
| N | | | |
| Netmask | 31, 35 | | |
| Network load | 169, 170 | | |
| Network management | 40 | | |
| Network management station | 262 | | |
| Network structure (PRP) | 159 | | |
| Non-volatile memory (NVM) | 57 | | |
| NVM (non-volatile memory) | 57 | | |
| O | | | |
| Object classes | 286 | | |
| Object description | 286 | | |
| Object ID | 286 | | |
| ODVA | 244 | | |
| ODVA website | 244 | | |
| OpenSSH-Suite | 23 | | |
| Operation monitoring | 203 | | |
| Option 82 | 274 | | |
| Ordinary clock (PTP) | 99 | | |
| P | | | |
| Password | 21, 23, 25 | | |
| Path costs | 171, 173 | | |
| PC Worx | 259 | | |
| Polling | 194 | | |
| Port Identifier | 170, 171 | | |
| Port mirroring | 221 | | |
| Port number | 171 | | |
| Port priority | 119 | | |
| Port priority (Spanning Tree) | 171 | | |
| Port roles (RSTP) | 178 | | |
| Port State | 179 | | |
| Priority | 115 | | |
| Priority queue | 116 | | |
| Priority tagged frames | 115 | | |
| Protection functions (guards) | 183 | | |
| PROFIBUS Organization | 256 | | |
| PRP | 142, 157 | | |
| PRP example configuration | 160 | | |
| PRP network structure | 159 | | |
| PRP RedBox (Example HSR) | 166 | | |
| PTP | 91 | | |
| PTP domain | 100 | | |
| PuTTY | 19 | | |
| Q | | | |
| QoS | 114 | | |
| Query | 107 | | |
| R | | | |
| Rapid Spanning Tree | 141, 141, 142, 178 | | |
| RADIUS | 44 | | |
| RAM (memory) | 57 | | |
| Real time | 113 | | |
| Reconfiguration | 170 | | |
| Reconfiguration time (MRP) | 145 | | |
| Record | 261, 264 | | |
| RedBox | 159 | | |
| Redundancy | 169 | | |
| Reference time source | 92, 95, 99 | | |
| Relay contact | 203 | | |
| Remote diagnostics | 203 | | |
| Report | 215 | | |
| Report message | 107 | | |
| Request Packet Interval | 245 | | |
| RFC | 288 | | |
| Ring | 144 | | |
| Ring manager | 144 | | |
| RIPE NCC | 30 | | |
| RMON probe | 221 | | |
| RM function | 144 | | |
| Root Bridge | 173 | | |
| Root guard | 183, 185 | | |
| Root path | 175, 176 | | |
| Root port | 178, 184 | | |
| Root Path Cost | 170 | | |
| Router | 31 | | |
| Routing Function | 245 | | |
| RPI | 245 | | |
| RSTP | 181 | | |
| RST BPDU | 178, 180 | | |
| RS Who | 245 | | |
| S | | | |
| SAN RedBox (HSR Example) | 163 | | |
| SAN (for HSR) | 163 | | |
| Secure shell | 19, 22 | | |
| Secure shell | 19 | | |
| Segmentation | 194 | | |
| Service | 215 | | |
| Service Shell Reactivation | 56 | | |
| Setting the time | 92 | | |
| SFP module | 211 | | |
| Signal contact | 203 | | |
| Simatic S7 | 259 | | |
| SNMP | 194 | | |
| SNMP trap | 194, 196 | | |
| SNTP | 91 | | |
| Software version | 69 | | |
| SSH | 19, 19, 22 | | |
| STP compatibility | 181 | | |
| STP-BPDU | 173 | | |
| Starting the graphical user interface | 18 | | |
| Store-and-forward | 104 | | |
| Strict Priority | 116 | | |
| Subidentifier | 286 | | |
| Subnet | 35 | | |
| Symbol | 245, 245, 259 | | |
| System requirements (GUI) | 18 | | |
| T | | | |
| TCN guard | 183, 185 | | |
| TCP/IP | 244, 256 | | |

| | |
|--------------------------------|------------|
| Technical questions | 301 |
| Threshold value | 258 |
| Topology Change flag | 183 |
| ToS | 113, 116 |
| Traffic class | 116, 119 |
| Training courses | 301 |
| Transmission reliability | 194 |
| Transparent clock (PTP) | 99 |
| Trap | 194, 196 |
| Trap destination table | 194 |
| Tree structure (Spanning Tree) | 173, 177 |
| Type of Service | 116 |
| U | |
| UDP/IP | 244, 256 |
| Update | 26 |
| User name | 21, 23, 25 |
| V | |
| Video | 116 |
| VLAN | 125 |
| VLAN priority | 119 |
| VLAN tag | 115, 125 |
| VoIP | 116 |
| VT100 | 24 |
| V.24 | 19, 24 |
| W | |
| Weighted Fair Queuing | 117 |
| Weighted Round Robin | 117 |

D Further support

Technical questions

For technical questions, please contact any Hirschmann dealer in your area or Hirschmann directly.

You find the addresses of our partners on the Internet at <http://www.hirschmann.com>.

A list of local telephone numbers and email addresses for technical support directly from Hirschmann is available at <https://hirschmann-support.belden.eu.com>.

This site also includes a free of charge knowledge base and a software download section.

Hirschmann Competence Center

The Hirschmann Competence Center is ahead of its competitors on three counts with its complete range of innovative services:

- ▶ Consulting incorporates comprehensive technical advice, from system evaluation through network planning to project planning.
- ▶ Training offers you an introduction to the basics, product briefing and user training with certification. You find the training courses on technology and products currently available at <http://www.hicomcenter.com>.
- ▶ Support ranges from the first installation through the standby service to maintenance concepts.

With the Hirschmann Competence Center, you decided against making any compromises. Our client-customized package leaves you free to choose the service components you want to use.

Internet:

<http://www.hicomcenter.com>

E Readers' Comments

What is your opinion of this manual? We are constantly striving to provide as comprehensive a description of our product as possible, as well as important information to assist you in the operation of this product. Your comments and suggestions help us to further improve the quality of our documentation.

Your assessment of this manual:

| | Very Good | Good | Satisfactory | Mediocre | Poor |
|---------------------|-----------------------|-----------------------|-----------------------|-----------------------|-----------------------|
| Precise description | <input type="radio"/> | <input type="radio"/> | <input type="radio"/> | <input type="radio"/> | <input type="radio"/> |
| Readability | <input type="radio"/> | <input type="radio"/> | <input type="radio"/> | <input type="radio"/> | <input type="radio"/> |
| Understandability | <input type="radio"/> | <input type="radio"/> | <input type="radio"/> | <input type="radio"/> | <input type="radio"/> |
| Examples | <input type="radio"/> | <input type="radio"/> | <input type="radio"/> | <input type="radio"/> | <input type="radio"/> |
| Structure | <input type="radio"/> | <input type="radio"/> | <input type="radio"/> | <input type="radio"/> | <input type="radio"/> |
| Comprehensive | <input type="radio"/> | <input type="radio"/> | <input type="radio"/> | <input type="radio"/> | <input type="radio"/> |
| Graphics | <input type="radio"/> | <input type="radio"/> | <input type="radio"/> | <input type="radio"/> | <input type="radio"/> |
| Drawings | <input type="radio"/> | <input type="radio"/> | <input type="radio"/> | <input type="radio"/> | <input type="radio"/> |
| Tables | <input type="radio"/> | <input type="radio"/> | <input type="radio"/> | <input type="radio"/> | <input type="radio"/> |

Did you discover any errors in this manual?
If so, on what page?

Suggestions for improvement and additional information:

General comments:

Sender:

Company / Department:

Name / Telephone number:

Street:

Zip code / City:

E-mail:

Date / Signature:

Dear User,

Please fill out and return this page

- ▶ as a fax to the number +49 (0)7127/14-1600 or
- ▶ per mail to

Hirschmann Automation and Control GmbH
Department 01RD-NT
Stuttgarter Str. 45-51
72654 Neckartenzlingen



HIRSCHMANN

A **BELDEN** BRAND