



HIRSCHMANN

A **BELDEN** BRAND

User Manual

Installation

Dragon PTN

Interface Module PTN-16-E1-L/PTN-16-T1-L

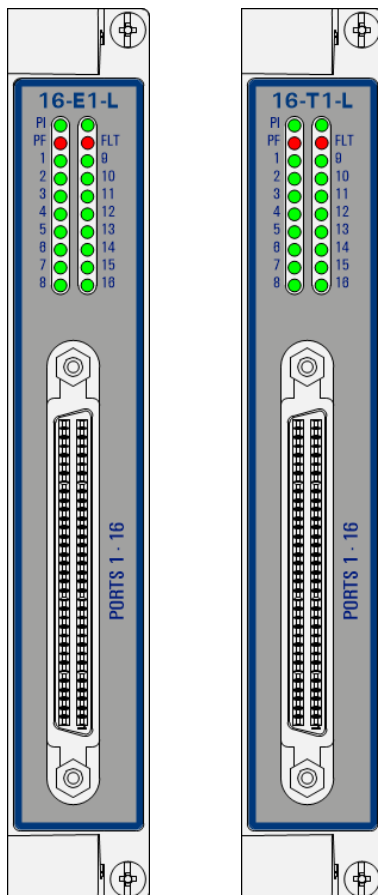

The naming of copyrighted trademarks in this manual, even when not specially indicated, should not be taken to mean that these names may be considered as free in the sense of the trademark and tradename protection law and hence that they may be freely used by anyone.

© 2018 Hirschmann Automation and Control GmbH

Manuals and software are protected by copyright. All rights reserved. The copying, reproduction, translation, conversion into any electronic medium or machine scannable form is not permitted, either in whole or in part. An exception is the preparation of a backup copy of the software for your own use.

The performance features described here are binding only if they have been expressly agreed when the contract was made. This document was produced by Hirschmann Automation and Control GmbH according to the best of the company's knowledge. Hirschmann reserves the right to change the contents of this document without prior notice. Hirschmann can give no guarantee in respect of the correctness or accuracy of the information in this document.

Hirschmann can accept no responsibility for damages, resulting from the use of the network components or the associated operating software. In addition, we refer to the conditions of use specified in the license contract.

You can get the latest version of this manual on the Internet at the Hirschmann product site (www.doc.hirschmann.com).

Hirschmann Automation and Control GmbH
Stuttgarter Str. 45-51
72654 Neckartenzlingen
Germany

Contents

1.	INTRODUCTION	6
1.1	General.....	6
1.2	Manual References.....	7
2.	MODULE DESCRIPTION	8
2.1	Front Panel	8
2.1.1	Insert/Remove Module into/from Node	8
2.1.2	LEDs.....	8
2.1.3	E1/T1 HPDB68 Connector and Cables	9
2.2	Functional Operation.....	14
2.2.1	General	14
2.2.2	E1 Framing	14
2.2.3	T1 Framing	15
2.2.4	AMI, HDB3 and B8ZS Coding	15
2.2.5	CES: SAToP	16
2.2.6	CES: CESoPSN	17
2.2.7	Start Sending Data	19
2.2.8	SAToP Compared With CESoPSN	19
2.2.9	Hitless Switching.....	19
2.2.10	Single Path	21
2.2.11	Delay Comparison in CES (Features)	22
2.2.12	I/O with the Central Switching Module (=CSM)	22
2.2.13	Synchronization / Clock Distribution / Network Timing.....	22
2.2.14	Short Haul/Long Haul	25
2.2.15	Test and Loopback Self Tests.....	25
2.3	Onboard Interfaces.....	25
2.3.1	Straps	26
2.3.2	DIP Switches	26
2.3.3	Hardware Edition	26
2.3.4	E1/T1 Configuration.....	26
3.	TDM FRAMES/PACKET	26
3.1	General.....	26
3.2	Bandwidth.....	27
3.3	Delay	27
3.3.1	General	27
3.3.2	Delay Parameters	28
3.3.3	Estimated Delay Calculation and Formulas	28
3.3.4	Estimated Delay Examples.....	29
3.3.5	Differential Delay	29
3.4	Tuning CES = Tuning TDM Frames/Packet.....	30
4.	COMPATIBILITY	30
5.	MODULE SPECIFICATIONS.....	30

5.1	General Specifications	30
5.2	Other Specifications	30
5.3	Ordering Information	31
6.	ABBREVIATIONS	31

List of figures

Figure 1	General E1/T1 Example	7
Figure 2	Front Panel	8
Figure 3	Drop Cable to RJ-45 Connection Unplugged	10
Figure 4	Drop Cable to RJ-45 Connection Plugged	10
Figure 5	Drop Cable via RJ-45 to BNC-Coax Connection Unplugged	11
Figure 6	Drop Cable via RJ-45 to BNC-Coax Connection Plugged	11
Figure 7	Drop Cable (1.5m) HPDB68 to Open End	12
Figure 8	E1/T1 RJ-45 Cable Connector	12
Figure 9	HPDB68 Connector	13
Figure 10	Detailed Function E1/T1 Example	14
Figure 11	E1 Framing	15
Figure 12	T1 Framing	15
Figure 13	HDB3 Encoding	16
Figure 14	T1: B8ZS Encoding	16
Figure 15	General SAToP Example	16
Figure 16	Detailed E1 SAToP Example	17
Figure 17	General CESoPSN Example	18
Figure 18	Detailed E1 CESoPSN Example	18
Figure 19	Hitless Switching	20
Figure 20	Single Path Enabled	21
Figure 21	Single Path Disabled	21
Figure 22	Clocking: Application D Slaves to Application A via Dragon PTN	23
Figure 23	Clocking: Both Applications A and D Slave to Dragon PTN Clock Master	23
Figure 24	16-E1-L/16-T1-L: Side View	25
Figure 25	SAToP, CESoPSN Bandwidth	27
Figure 26	Delays	28
Figure 27	Differential Delay	29

List of Tables

Table 1	Manual References	7
Table 2	LED Indications In Boot Operation	9
Table 3	LED Indications In Normal Operation	9
Table 4	Connection Products	10
Table 5	E1/T1 RJ-45 Cable Connector: Pin Assignments	12
Table 6	HPDB68 Connector - Drop Cable: Pin Assignments	13

Table 7 Comparison: SAToP \leftrightarrow CESoPSN	19
Table 8 Difference Between Hitless and Protection Switching.....	20
Table 9 Clocking Parameters on Port & Service Level.....	24
Table 10 TDM Frames/Packet	26
Table 11 Maximum Number Of Bundles.....	27
Table 12 Estimated Delay Formulas	28
Table 13 Estimated Delay (μ s) Examples.....	29
Table 14 Other Specifications.....	30

1. INTRODUCTION

1.1 General

This document is valid as of Dragon PTN Release 4.0DR.

E1 and T1 links are used worldwide to implement synchronous TDM links between two end points. These links typically transport voice and/or data using TDM. The application of E1 or T1 is country related. T1 is primarily used on the North American continent and Japan whereas E1 is used in most other areas. Both carriers differ with respect to the physical interface, the framing algorithm, signaling and network management.

The 16-E1-L/16-T1-L interface module (=IFM) is a high density E1/T1 module and provides 16 E1/T1 ports for connecting E1/T1 TDM links to the Dragon PTN network. 16-E1-L/16-T1-L refers to '16 ports – E1/T1 – LAN'.

Verify the 'Dragon PTN Bandwidth Overview' manual (Ref. [100] in Table 1) to see in which node and IFM slot this IFM can be used.

This IFM converts the E1/T1 framing from an E1/T1 link into MPLS-TP packets over the Dragon PTN network, and vice versa. The destination IFM must also compensate for possible jitter and network delays to keep everything synchronized. A packetized TDM service is called a Circuit Emulation Service (=CES). A maximum of 64 CESes (with a maximum of 32 Hitless switching services) can be configured per 16-E1-L/16-T1-L module.

The main supported features are:

- ▶ Packetizing of E1/T1 Framing
- ▶ LAN function
- ▶ Services
 - ▶ SAToP (=Structured Agnostic TDM over Packet) → all channels transparently;
 - ▶ CESoPSN (=CES over Packet Switched Network) → customized channel transport;
 - ▶ Hitless Switching / Single Path;
- ▶ Synchronization
 - ▶ SyncE;
- ▶ Compatible products can be found in §4.

A general E1/T1 example can be found in the figure below:

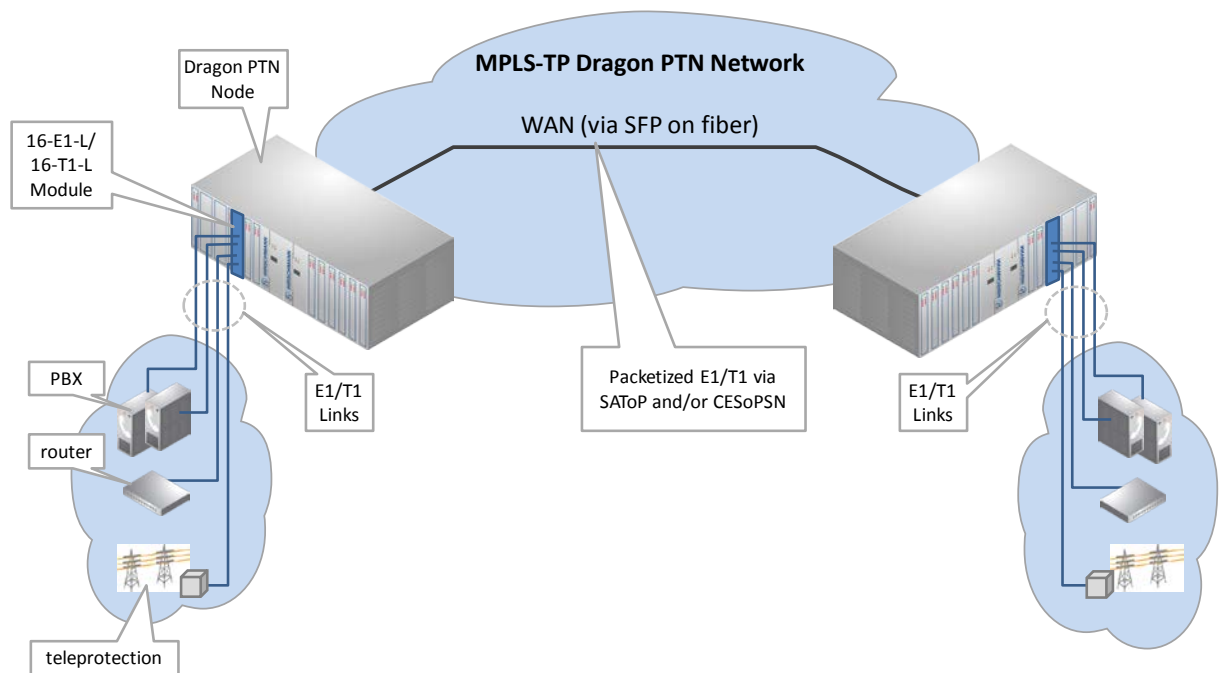

Figure 1 General E1/T1 Example

1.2 Manual References

Table 1 is an overview of the manuals referred to in this manual. ‘&’ refers to the language code, ‘*’ refers to the manual issue. All these manuals can be found in the HiProvision (=Dragon PTN Management System) Help function.

Table 1 Manual References

Ref.	Number	Title
[1]	DRA-DRM821-&-*	Dragon PTN and HiProvision Operation
[2]	DRA-DRM801-&-*	Dragon PTN Installation and Operation
[4]	DRB-DRM803-&-*	Dragon PTN Switching Module: PTN-CSM310-A
[5]	DRE-DRM809-&-*	Dragon PTN Interface Module: PTN-2-C37.94
[6]	DRA-DRM810-&-*	Dragon PTN General Specifications
[7]	DRA-DRM805-&-*	Dragon PTN Interface Module: PTN-4-E1-L/PTN-4-T1-L
[100]	DRA-DRM828-&-*	Dragon PTN Bandwidth Overview

2. MODULE DESCRIPTION

2.1 Front Panel

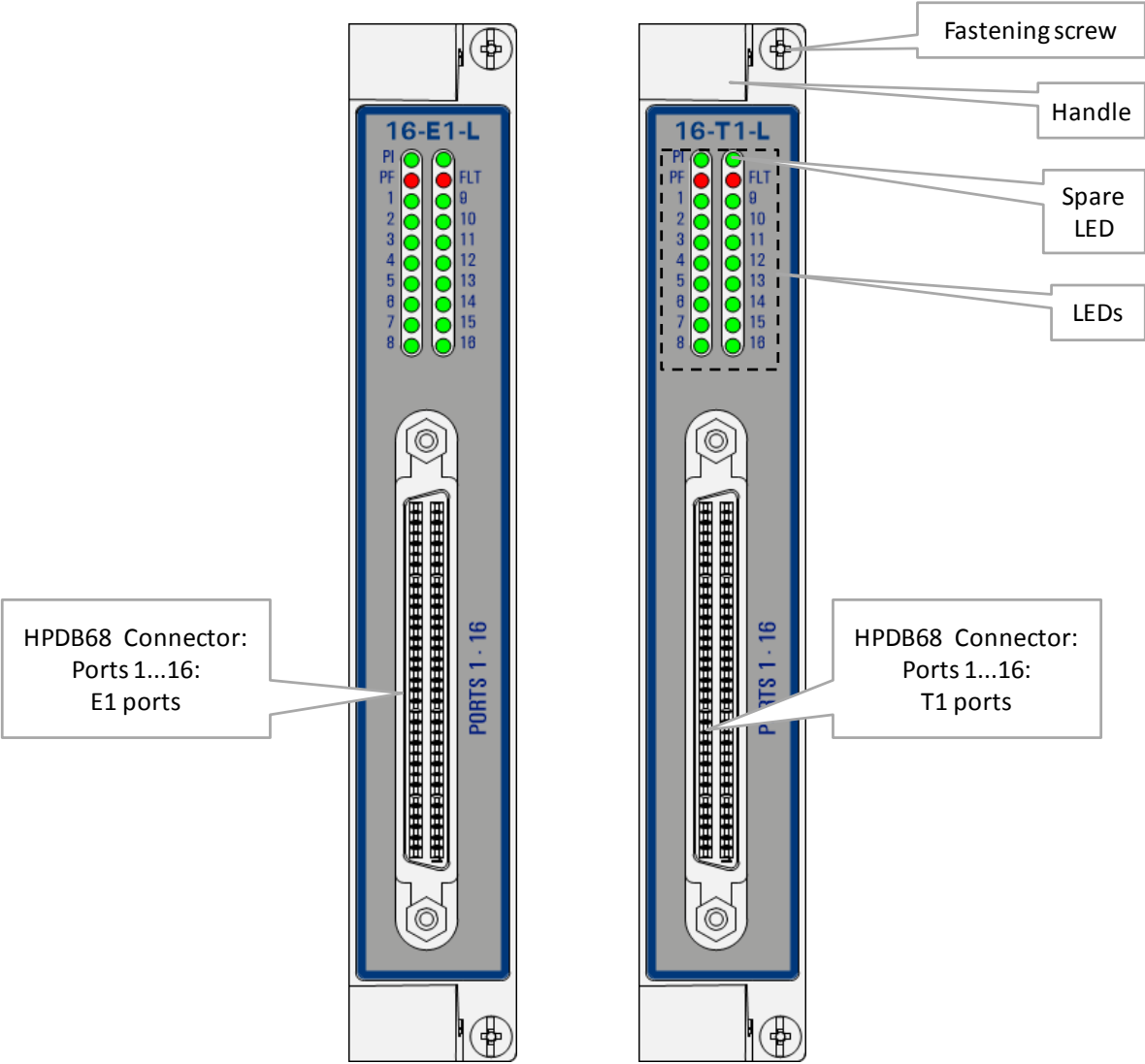

Figure 2 Front Panel

2.1.1 Insert/Remove Module into/from Node

See ‘Dragon PTN Installation and Operation Manual’ Ref.[2].

2.1.2 LEDs

The meaning of the LEDs depends on the mode of operation (= boot or normal) in which the 16-E1-L/16-T1-L module currently is running. After plugging in the module or rebooting it, the module turns into the boot operation, see Table 2. After the module has gone through all the cycles in the table below (=rebooted successfully), the module turns into the normal operation, see LEDs in Table 3.

Table 2 LED Indications In Boot Operation

Cycle	PI	PF	FLT	Spare LED	Port[1]	Port[2..16]
1	x	---	x	---	Slow blinking	---
2	x	---	x	---	Fast blinking	---
3	x	---	---	---	Fast blinking	---
4	x	---	---	---	---	---
5	x	---	x	x	x	x

x : LED is lit / --- : LED is not lit
 The sub cycle times may vary. The entire boot cycle time [1→ 5] takes approximately 2 minutes.

Table 3 LED Indications In Normal Operation

LED	Color	Status
PI (=Power Input)	Not lit, dark	+12V power input to the board not OK
	Green	+12V power input to the board OK
PF (=Power Failure)	Not lit, dark	power generation on the board itself is OK
	Red	power generation on the board itself is erroneous
FLT (=FauLT)	Not lit, dark	no other fault or error situation, different from PF, is active on the module
	Red	a fault or error situation, different from PF, is active on the module
Spare	Not lit, Green	spare
<port n°>	Not lit, dark	- no service on this port - service on this port: local E1/T1 traffic on this front port is OK
	(1*) Red, lit	service on this port: local E1/T1 signal is lost on this front port
	(2*) Red, fast blinking	AIS, LOF or RAI received on this local front port
	(3*) Red, slow blinking	An error occurred on the remote site (=backplane side)

(*): Indicates the priority. (1*) = highest priority, (3*) = lowest priority. If multiple simultaneous error events occur that influence the <port n°> LED, the highest priority situation wins.
 Example: if a local AIS occurs (2*) together with an error at the remote side (3*), the LED will be red, fast blinking.

2.1.3 E1/T1 HPDB68 Connector and Cables

The 16-E1-L/16-T1-L module provides 16 E1/T1 ports via a HPDB68 connector. Each port provides one tip/ring pair. Connections to this IFM can be made in following ways:

- ▶ Via a drop cable (2m) HPDB68 to 16 RJ-45 with RJ-45 couplers together with the 24 ports feedthrough patch panel. Each RJ-45 port connector has eight pins which provides one tip/ring pair. E1/T1 cables must be used to connect these ports;
- ▶ Via a drop cable (2m) HPDB68 to 16 RJ-45 with a 16 ports RJ-45 to BNC-coax patch panel. Each RJ-45 port connector has eight pins which provides one tip/ring pair. Coax cables must be used to connect these ports;
- ▶ Via a drop cable (1.5m) HPDB68 to open end which can be wired later on to punch-down connectors. These punch-down-connectors must be provided by the customer.
- ▶ See the table and figures below for an overview and description of the different connections, connectors and pin assignments.

Table 4 Connection Products

Description	Ordering Number
Drop cable (2m) HPDB68 to 16 RJ-45 with RJ-45 coupler	942 256-203
Patch panel 1 U feedthrough 24 ports (to be used in combo with 942 256-203)	942 256-204
E1 cable (120 Ω)	942 256-201
T1 cable (100 Ω)	942 256-200
Drop cable (2m) HPDB68 to 16 RJ-45 with 16 ports RJ-45 to BNC-Coax patch panel	942 256-205
Drop cable (1.5m) HPDB68 to open end	942 256-202

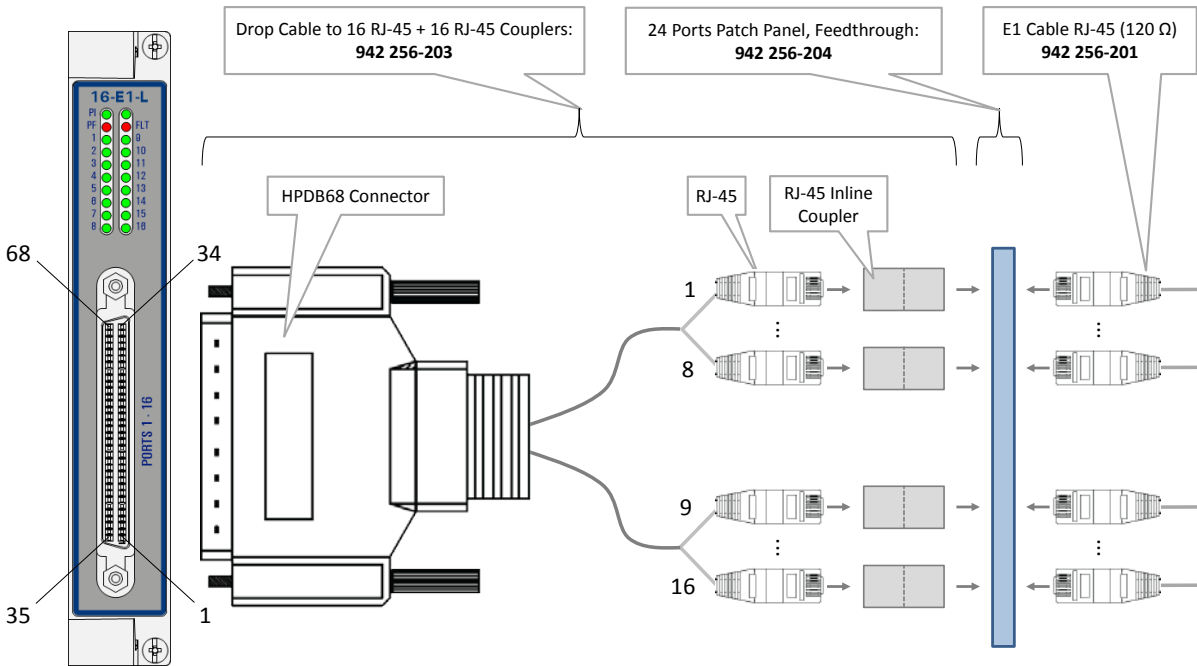

Figure 3 Drop Cable to RJ-45 Connection Unplugged

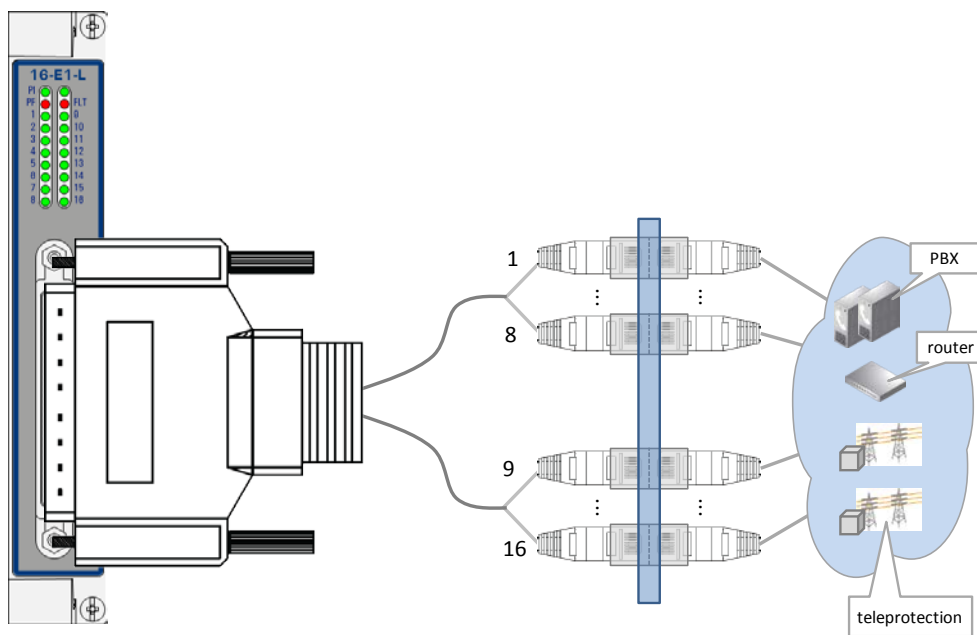

Figure 4 Drop Cable to RJ-45 Connection Plugged

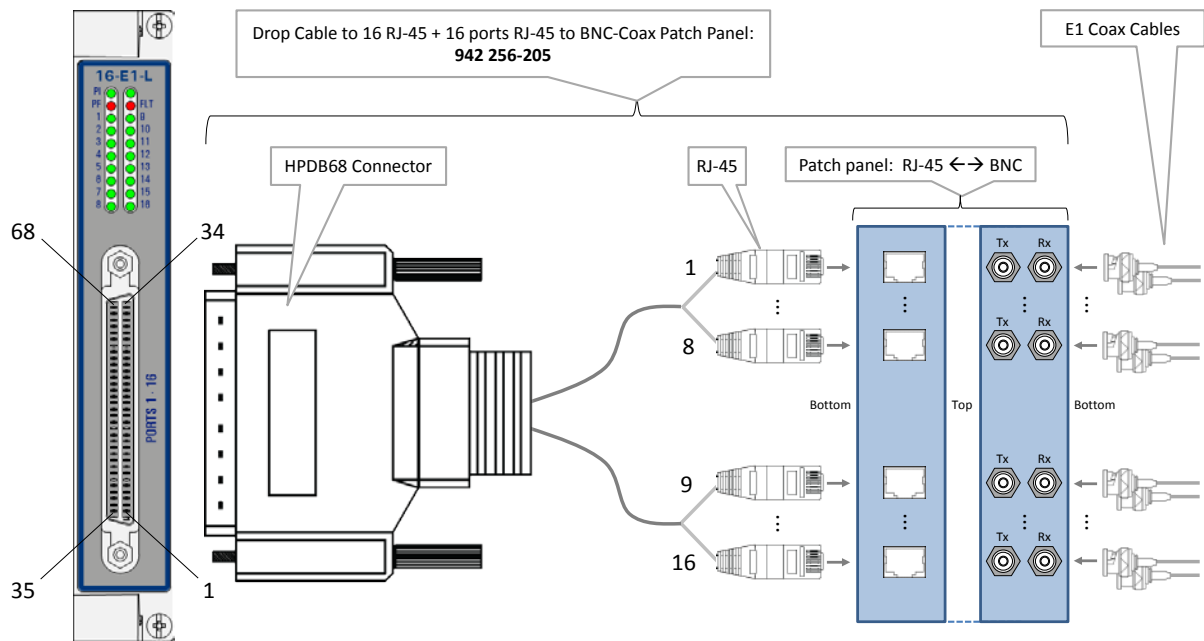

Figure 5 Drop Cable via RJ-45 to BNC-Coax Connection Unplugged

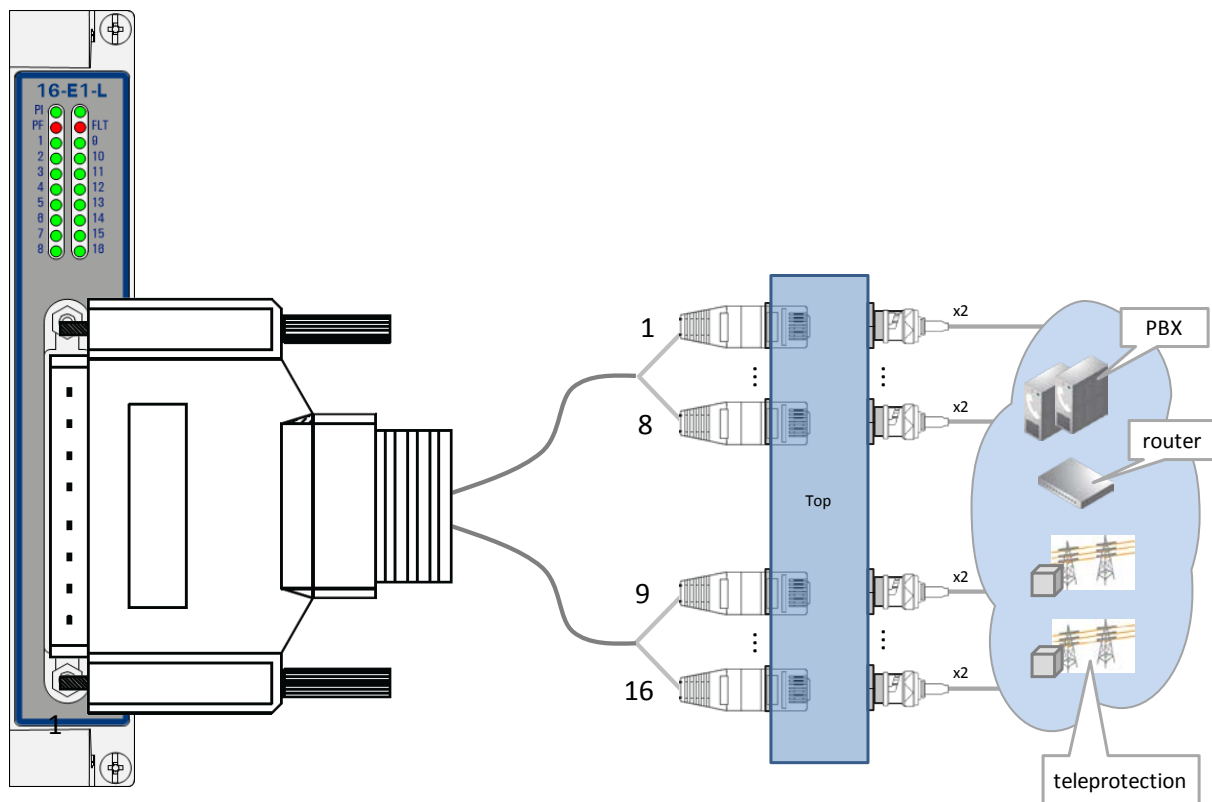

Figure 6 Drop Cable via RJ-45 to BNC-Coax Connection Plugged

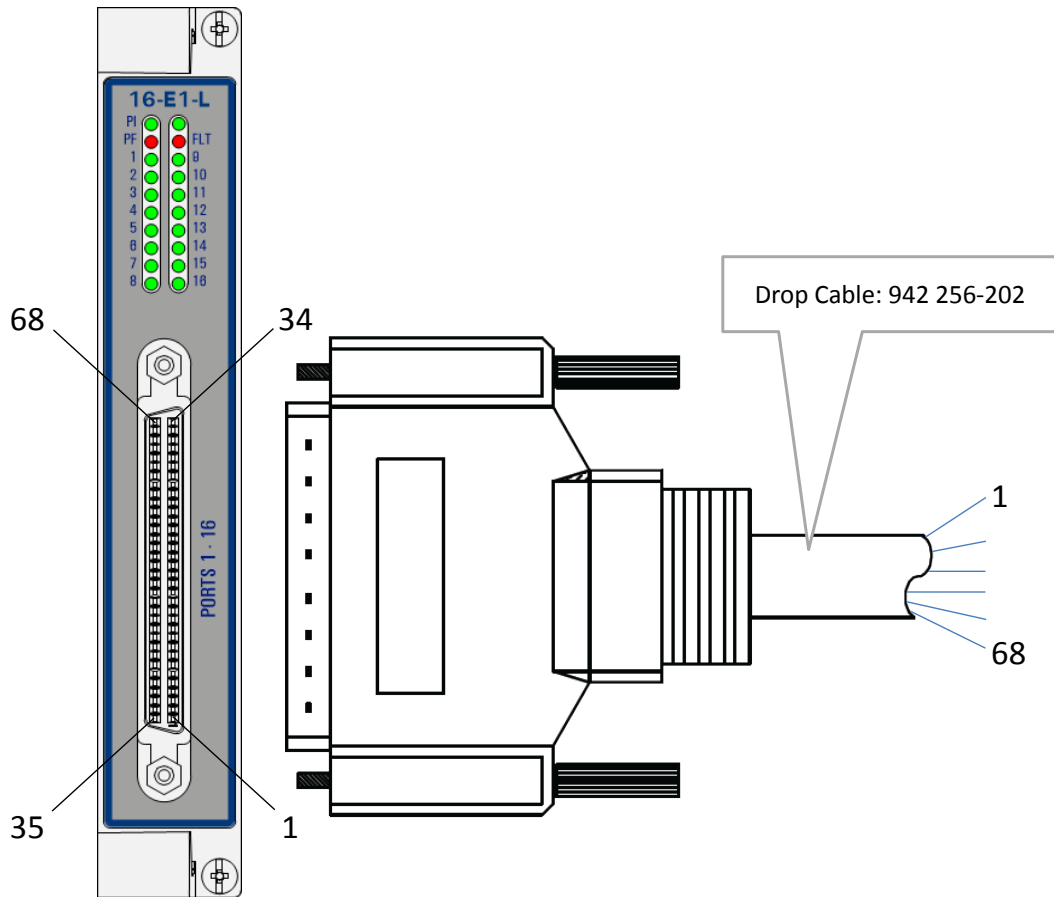

Figure 7 Drop Cable (1.5m) HPDB68 to Open End

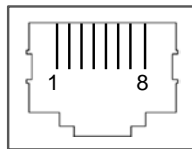

Figure 8 E1/T1 RJ-45 Cable Connector

Table 5 E1/T1 RJ-45 Cable Connector: Pin Assignments

Pin Number	Description	Cable Wire Colors
1	Rx (Receive) RING	OG
2	Rx (Receive) TIP	WH/OG
3	Not connected	-
4	Tx (Transmit) RING	BU
5	Tx (Transmit) TIP	WH/BU
6, 7, 8	Not connected	-

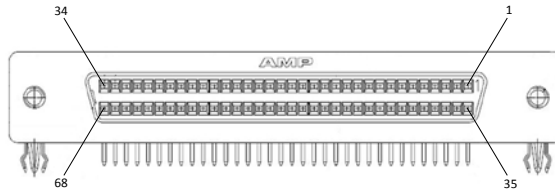

Figure 9 HPDB68 Connector

Table 6 HPDB68 Connector - Drop Cable: Pin Assignments

Pin No.	Cable Wire Color	E1/T1 Port			Pin No.	Cable Wire Color	E1/T1 Port		
		No.	(RJ-45) Pin No.	Signal (*)			No.	(RJ-45) Pin No.	Signal (*)
1	Black	/	/	/	35	Dark yellow	/	/	/
1	Black	/	/	/	35	Dark yellow	/	/	/
2	Black / white	/	/	/	36	Dark yellow / black	/	/	/
3	Light brown	16	2	R_TIP_P16	37	Grey	16	1	R_RING_P16
4	Light brown / red	16	5	T_TIP_P16	38	Grey / black	16	4	T_RING_P16
5	Green	15	2	R_TIP_P15	39	Red	15	1	R_RING_P15
6	Green / black	15	5	T_TIP_P15	40	Red / black	15	4	T_RING_P15
7	Blue	14	2	R_TIP_P14	41	Purple	14	1	R_RING_P14
8	Blue / white	14	5	T_TIP_P14	42	Purple / white	14	4	T_RING_P14
9	Light blue	13	2	R_TIP_P13	43	Pink	13	1	R_RING_P13
10	Light blue / black	13	5	T_TIP_P13	44	Pink / black	13	4	T_RING_P13
11	Brown	12	2	R_TIP_P12	45	White	12	1	R_RING_P12
12	Brown / white	12	5	T_TIP_P12	46	White / black	12	4	T_RING_P12
13	Orange	11	2	R_TIP_P11	47	Light green	11	1	R_RING_P11
14	Orange / black	11	5	T_TIP_P11	48	Light green / black	11	4	T_RING_P11
15	Yellow	10	2	R_TIP_P10	49	Blue / Red	10	1	R_RING_P10
16	Yellow / red	10	5	T_TIP_P10	50	Purple / Red	10	4	T_RING_P10
17	Grey / red	9	2	R_TIP_P9	51	Purple / blue	9	1	R_RING_P9
18	Grey / blue	9	5	T_TIP_P9	52	Purple / green	9	4	T_RING_P9
19	Light green / blue	8	2	R_TIP_P8	53	Light blue / red	8	1	R_RING_P8
20	Green / white	8	5	T_TIP_P8	54	Light blue / blue	8	4	T_RING_P8
21	Light green / red	7	2	R_TIP_P7	55	Pink / red	7	1	R_RING_P7
22	Green / blue	7	5	T_TIP_P7	56	Pink / blue	7	4	T_RING_P7
23	Grey / yellow	6	2	R_TIP_P6	57	Yellow / white	6	1	R_RING_P6
24	Grey / green	6	5	T_TIP_P6	58	Yellow/ black	6	4	T_RING_P6
25	Red / white	5	2	R_TIP_P5	59	Yellow/ blue	5	1	R_RING_P5
26	Red / blue	5	5	T_TIP_P5	60	Yellow/ green	5	4	T_RING_P5
27	White / red	4	2	R_TIP_P4	61	Dark yellow/ red	4	1	R_RING_P4
28	White / blue	4	5	T_TIP_P4	62	Dark yellow/ blue	4	4	T_RING_P4
29	Pink / white	3	2	R_TIP_P3	63	White/ yellow	3	1	R_RING_P3
30	Pink / orange	3	5	T_TIP_P3	64	White / green	3	4	T_RING_P3
31	Light blue / yellow	2	2	R_TIP_P2	65	Light green / yellow	2	1	R_RING_P2
32	Light blue / green	2	5	T_TIP_P2	66	Light green / green	2	4	T_RING_P2
33	Orange / red	1	2	R_TIP_P1	67	Orange / white	1	1	R_RING_P1
34	Orange / green	1	5	T_TIP_P1	68	Grey / white	1	4	T_RING_P1

(*) R = Receive / T = Transmit

2.2 Functional Operation

2.2.1 General

An application network (e.g. LAN1) can be connected to the MPLS-TP Dragon PTN network via one of the 16 E1/T1 interface ports. The 16-E1-L/16-T1-L module can interface with 16 E1/T1 lines. In Figure 1, a common functional setup is shown.

In Figure 10 below, a more detailed functional setup is shown. A LAN1 network interfaces the Dragon PTN node via the E1/T1 ports on the 16-E1-L/16-T1-L module. The 16-E1-L/16-T1-L converts this traffic into Ethernet traffic on the backplane. The Central Switching Module (=CSM, see Ref. [4],[4b] in Table 1) converts this Ethernet traffic into packetized E1/T1 MPLS-TP and transmits it via an Ethernet IFM (e.g. 4-GC-LW) onto the Dragon PTN MPLS-TP network. The packetizing of E1/T1 occurs via CES: SAToP (see §2.2.5) or CES: CESoPSN (see §2.2.6) technique.

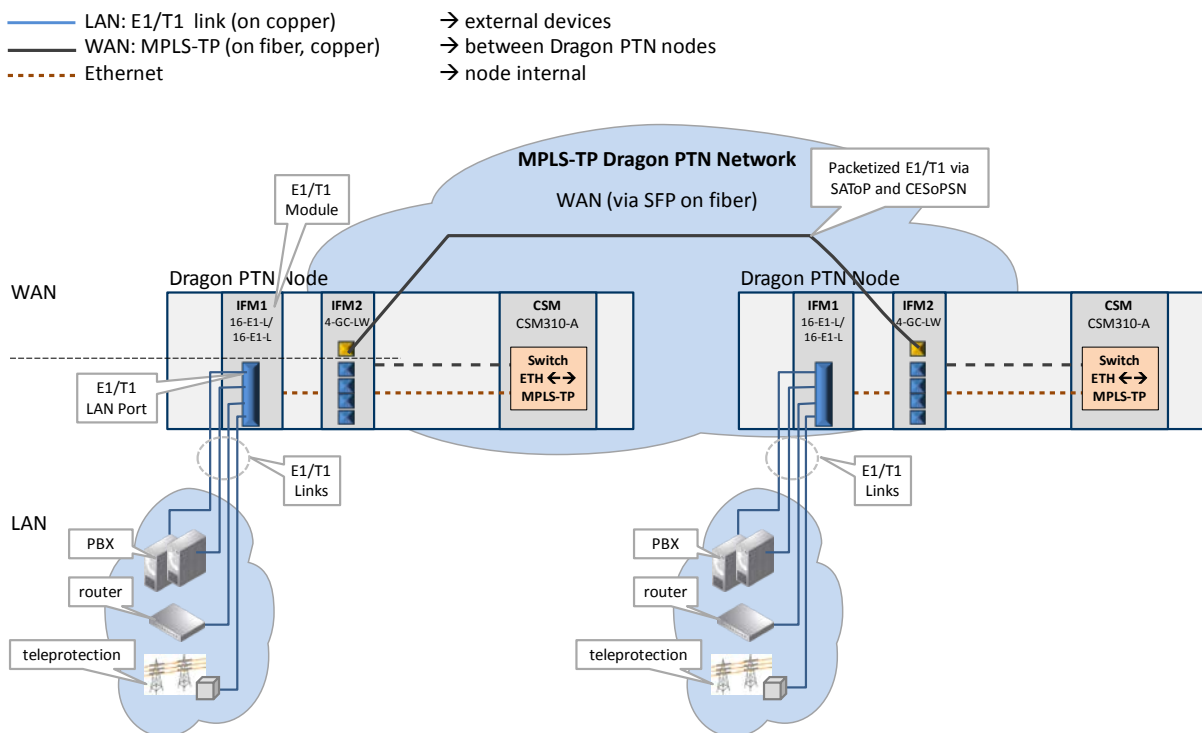

Figure 10 Detailed Function E1/T1 Example

2.2.2 E1 Framing

E1 is a 2.048 Mbps bi-directional (full duplex) link through which the data is transported in a digital way in frames. One frame consists of 32 time slots (Figure 11). Time slot 0 is used for framing and synchronization, and time slot 16 for signaling. The bandwidth of one time slot is 64 kbps (=8 bits/125 μ s). One frame thus consists of 32*8 = 256 bits and lasts 125 μ s. Typically 16 frames are packed together in one multiframe.

NOTE: Multiframe = future support;

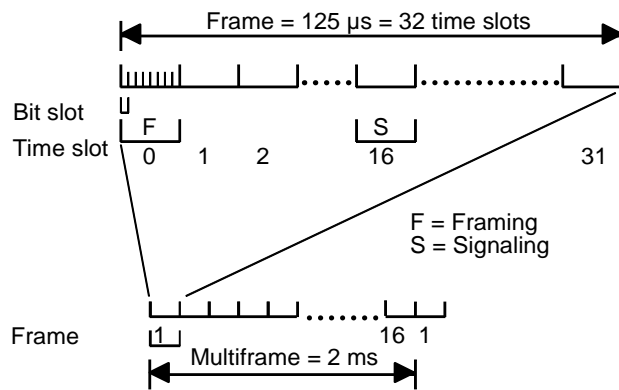

Figure 11 E1 Framing

2.2.3 T1 Framing

T1 is a 1.544 Mbps bi-directional (full duplex) link through which the data is transported in a digital way in frames. One frame consists of 24 time slots + 1 bit (Figure 12). The extra bit is used for framing. The bandwidth of one time slot is 64 kbps (8 bits). One frame thus consists of $(24 \times 8) + 1 = 193$ bits and lasts 125 μs. Depending of the framing algorithm applied either 12 or 24 frames are packed together in one multiframe. Signaling bits are transported in the Least Significant Bit of the time slots in each multiframe agreed upon (in-band).

NOTE: Multiframe = (E)SF (=Extended) Super Frame) = future support;

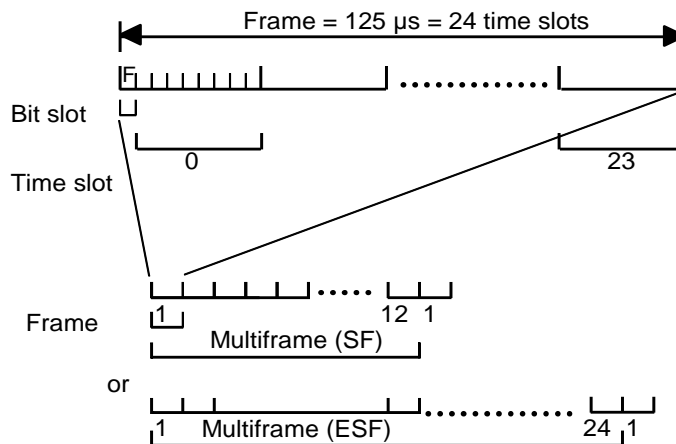

Figure 12 T1 Framing

2.2.4 AMI, HDB3 and B8ZS Coding

AMI, HDB3 and B8ZS are different types of line coding. HDB3 is used in E1 whereas B8ZS is used in T1 communications systems. The 16-E1-L/16-T1-L module supports HDB3 for E1 and B8ZS for T1. HDB3 and B8ZS is an enhancement of AMI. For this reason, AMI is mentioned here as well.

As the E1/T1 link has no separate clock transmission, the receiver will derive the clock from the incoming data stream. A minimum density of logical ones is required in order to guarantee a faultless clock recovery. This is achieved basically by AMI which encodes the data stream with bipolar violations. A more enhanced and better encoding is HDB3 and B8ZS which enhance the AMI stream by replacing successive zeros:

- ▶ E1 → HDB3: replace four successive zeros with a fixed bit pattern '000V' or 'B00V';
- ▶ T1 → B8ZS: replace eight successive zeros with a fixed bit pattern '000VB0VB';

A 'B' and 'V' can either be '-' or '+'. Which pattern is used depends on the amount of '+' and '-' already received from send on the link. The choice is such that the number of pluses (+) between two successive violations (V) is odd.

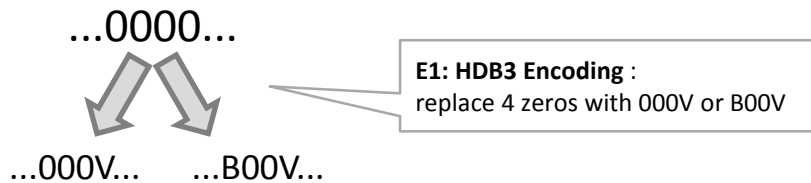

Figure 13 HDB3 Encoding

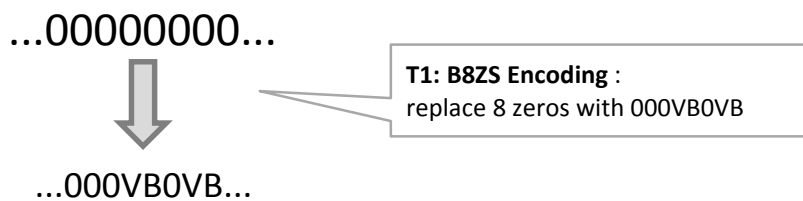

Figure 14 T1: B8ZS Encoding

2.2.5 CES: SAToP

SAToP is a point-to-point CES which sends transparently the entire E1/T1 frame from the source to the destination E1/T1 port over the MPLS-TP network. The entire frame = all data + synchronization + alignment timeslots = 32 timeslots for E1 and 24 timeslots for T1. As a result, maximum one SAToP service can be configured per port.

NOTE: Each end-point or E1/T1 port must be located in a different node. Future: end-points can also be located intra-module or intra-node.

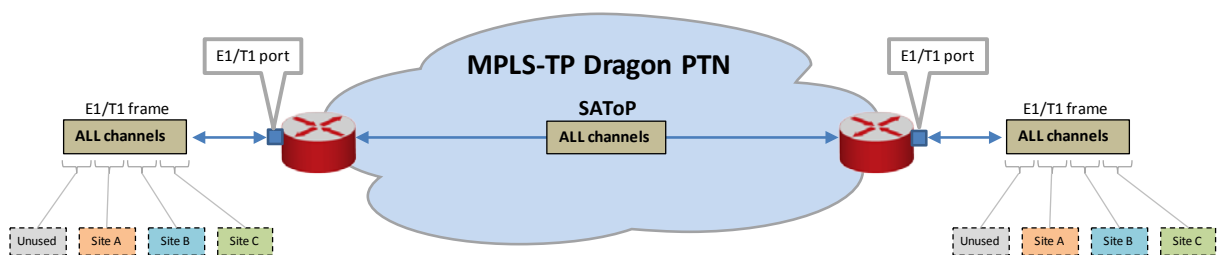

Figure 15 General SAToP Example

In the next below, a more detailed example has been worked out.

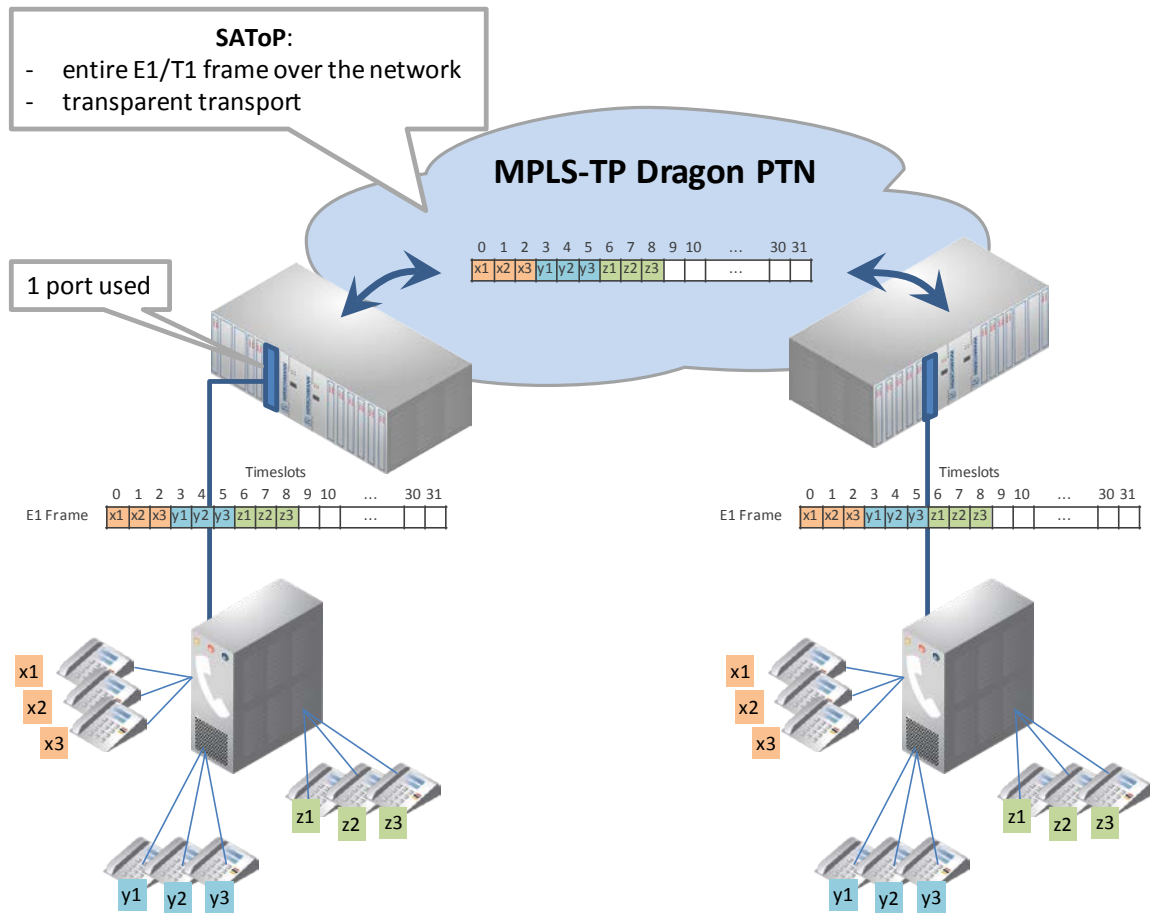

Figure 16 Detailed E1 SAToP Example

2.2.6 CES: CESoPSN

CESoPSN is a point-to-point CES which only sends a selection of channels or timeslots over the MPLS-TP Dragon PTN network. In HiProvision (=Dragon PTN Management System), the operator selects which timeslots of the input frame (E1 or T1) must be transported. This customized transportation of timeslots through the network results in a more efficient bandwidth use.

The destination module will receive the transported channels from the Dragon PTN network, and regenerate all the other missing timeslots itself (empty or dummy timeslots, synchronization). As a result, the destination sends out the entire regenerated frame (E1 or T1) on its port.

Each end-point or port (E1 or T1) must be located in a different node.

CESoPSN services can be configured:

- ▶ Between two or more E1 ports, see below;
- ▶ Between two or more T1 ports, see below;
- ▶ Between a C37.94 and an E1 port, see below;
- ▶ Between a C37.94 and a T1 port, see below;

a. Between Two or More E1 Ports

Multiple CESs per port can be configured to transport an amount of timeslots between two or more E1 ports. In HiProvision, the operator selects the timeslots individually to be transported per CES. On both the source and destination side, the same amount of timeslots must be selected. The selected timeslots from the source side can be mapped onto the timeslots from the destination side.

The timeslot order does not change during the mapping. The first selected source timeslot will be mapped automatically onto the first selected destination timeslot etc....

See some examples in the figures below.

NOTE: In E1, timeslot 0 cannot be transported;

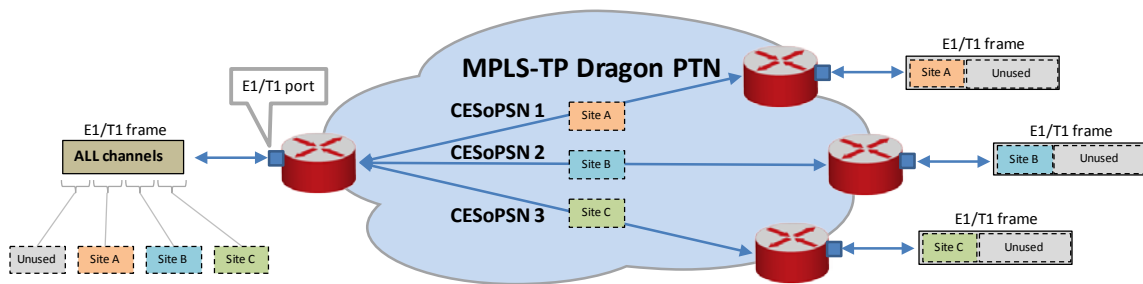

Figure 17 General CESoPSN Example

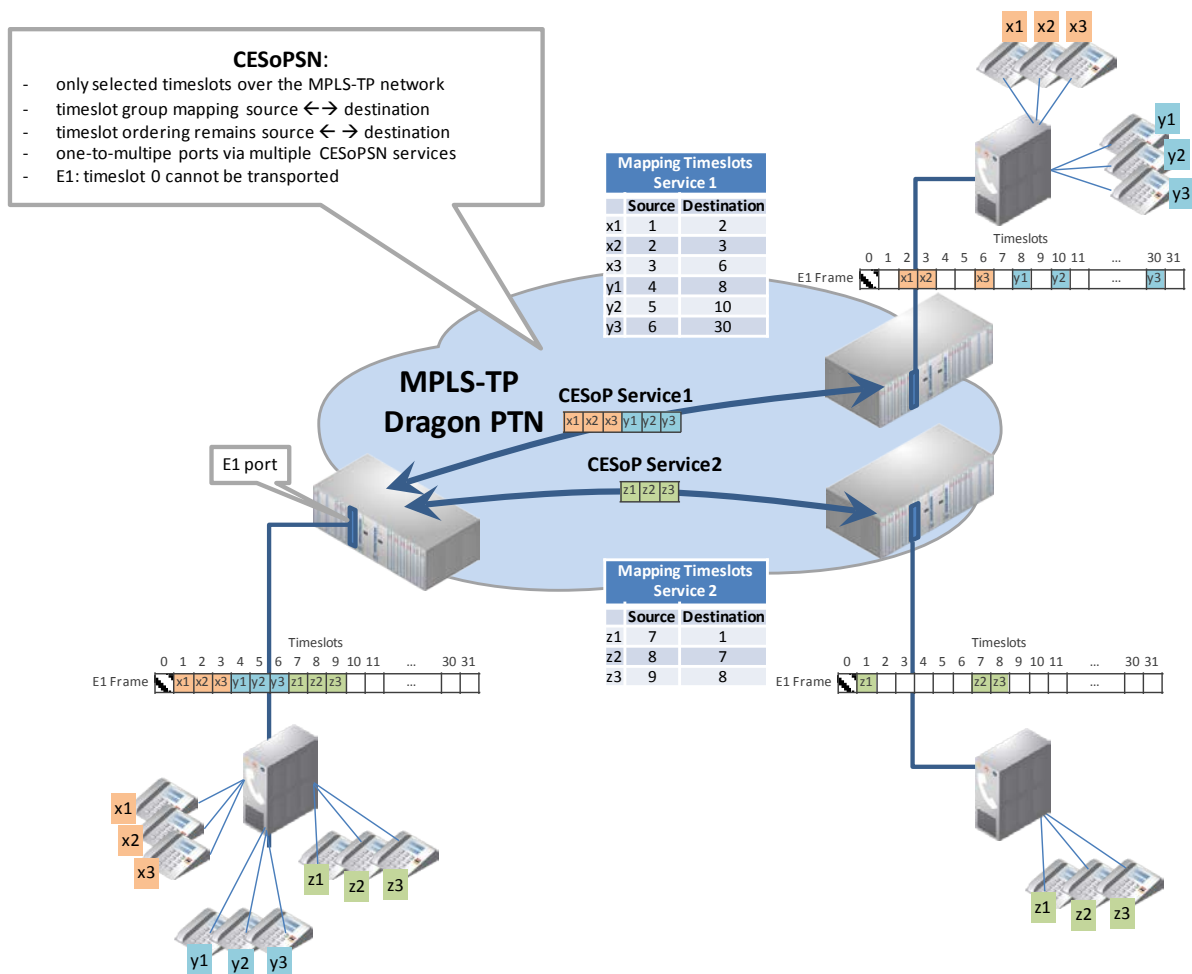

Figure 18 Detailed E1 CESoPSN Example

b. Between Two or More T1 Ports

Similar to §2.2.6a.

c. Between a C37.94 and an E1 Port

See Ref.[5] in Table 1;

d. Between a C37.94 and an T1 Port

See Ref.[5] in Table 1;

2.2.7 Start Sending Data

It can be configured when a SAToP service starts sending data. See 'send data' in the 'Dragon PTN and HiProvision Operation' Manual (=Ref. [1]) for more information.

2.2.8 SAToP Compared With CESoPSN

Table 7 Comparison: SAToP ↔ CESoPSN

	SAToP	CESoPSN
amount of services/port	1	31 (=E1) or 24 (=T1);
amount of used timeslots or channels/service	always 32 for E1 and 24 for T1, including synchronization and alignment data.	must be configured, amount on input = amount on output; timeslot 0 is never transported;
timeslot mapping	just port to port configuration, 'timeslot x' on the input side will always be 'timeslot x' on the output side.	time slot mapping between input side and output side must be configured, 'timeslot x' on the input side could be mapped to 'timeslot y' on the output side; Per CESoPSN service, the timeslots on the input side must be part of the same port, the timeslots on the output side must be part of the same port. All the data channels on an input port can be mapped on different CESoPSN services, which can have different destination ports.

2.2.9 Hitless Switching

Hitless Switching is a feature within SAToP/CESoPSN that provides a safe E1/T1 redundant connection where no data or synchronization is lost when switching from the active to the backup path or vice versa, e.g. because of cable break. The total delay over the network remains nearly constant during switch-over. Redundancy via Hitless Switching is obtained via completing the list below:

- ▶ creating two independent point-to-point tunnels without protection;
- ▶ setting the Hitless Switching on at service creation time in HiProvision.

NOTE: See Ref.[1] for the creation of tunnels and services;

On the source side, with Hitless Switching enabled, the E1/T1 IFM duplicates each packet on a second tunnel (e.g. Tunnel y, see figure below). Each packet also contains a 16 bit sequence number. Different tunnels mean different paths through the network, with each path its own delay. Different delays result in a slow and a fast path.

On the destination side, with Hitless Switching enabled, the E1/T1 IFM buffers the fastest path and forwards packets from the slowest path on the E1/T1 link. Packets will be processed according a packet sequence number.

Hitless Switching is a redundant mechanism but differs from Protection Switching, see the table below for an overview. So if redundancy is needed in the service, either choose Hitless Switching or Protection Switching, mixing up both mechanisms is not allowed. Depending on the choice, settings must be done at tunnel creation time and/or service creation time.

When Hitless Switching has been enabled, the CES can only start up with two links up, coming out of a two-links-down situation (except when Single Path has been enabled, see §2.2.10).

See §2.2.11 for a delay comparison within CES depending on the enabled sub features, see also further on.

Table 8 Difference Between Hitless and Protection Switching

	E1/T1 Protection Switching	E1/T1 Hitless Switching
required tunnel type	1 point-to-point tunnel	2 point-to-point tunnels
tunnel protection type	1:1;	none; the redundancy is created via two independent point-to-point tunnels.
service parameter	Hitless Switching = disabled	Hitless Switching = enabled
at switch-over	possible data loss	no data or synchronization loss
total delay	less than hitless switching	more than protection switching

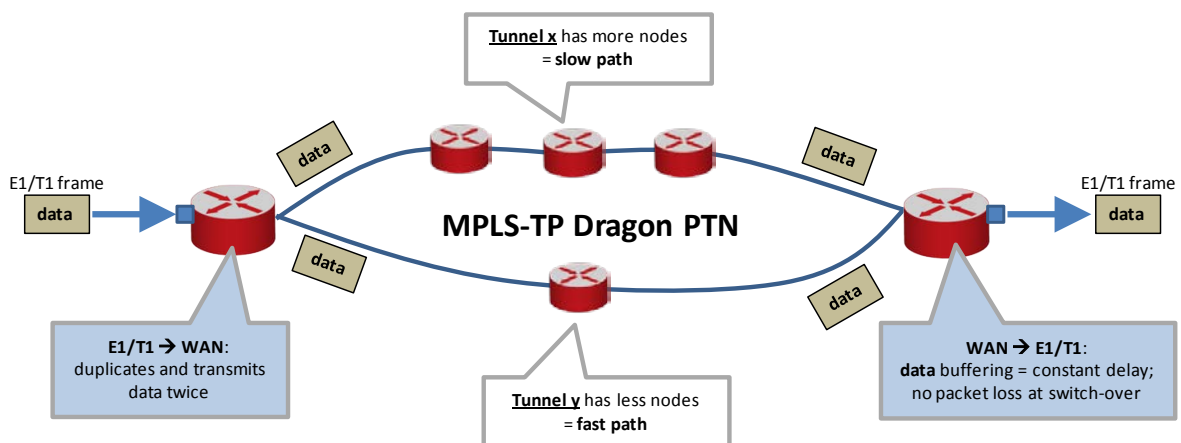

Figure 19 Hitless Switching

2.2.10 Single Path

The Single Path feature is a sub feature of Hitless Switching (see §2.2.9). It influences the start-up behavior of the Hitless Switching mechanism:

- ▶ enabled: The CES can already start up with only one link up, coming out of a two-links-down situation.
 - ▶ if the fastest path came up first:
 - ▶ the CES starts up according to the fastest path;
 - ▶ possible CES interrupt or minor packet loss when the slowest path comes up later on;
 - ▶ if the slowest path came up first:
 - ▶ the CES starts up according to the slowest path;
 - ▶ no CES interrupt or packet loss when the fastest path comes up later on;

See §2.2.11 for a delay comparison within CES depending on the enabled sub features, see also further on.

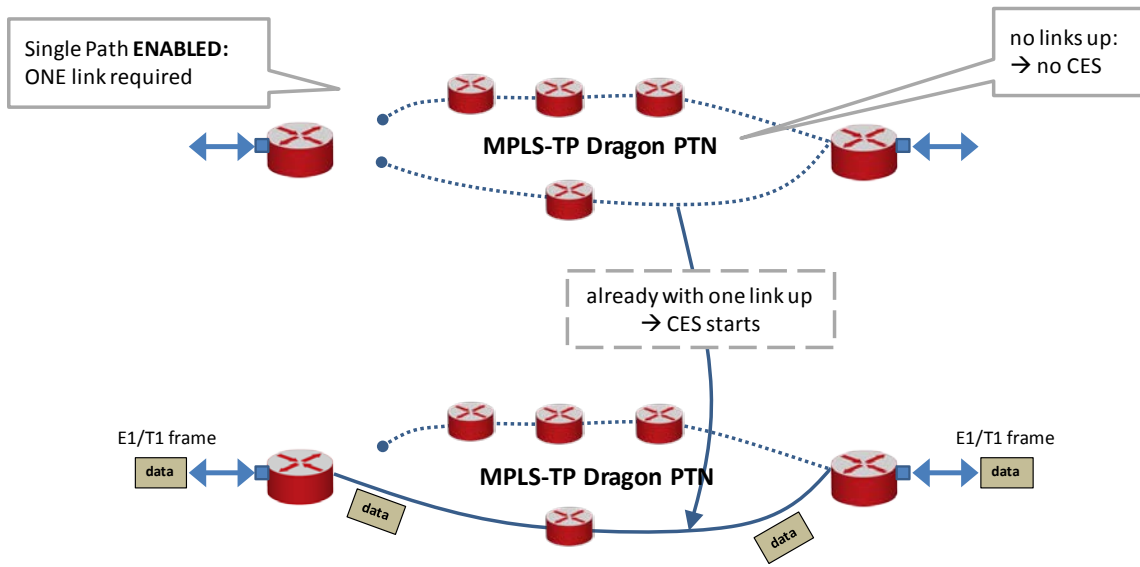

Figure 20 Single Path Enabled

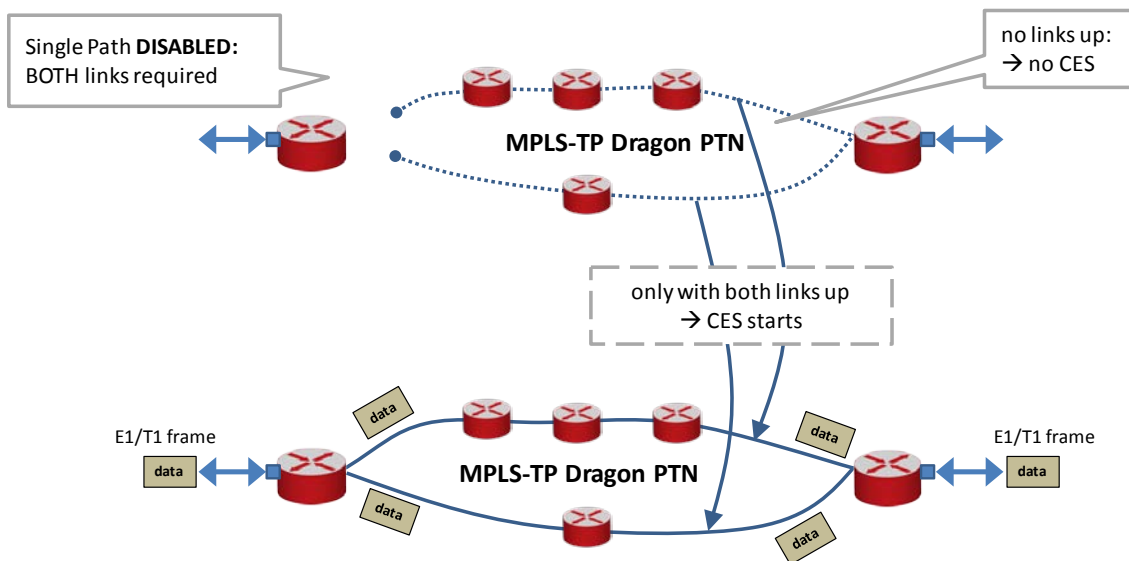

Figure 21 Single Path Disabled

2.2.11 Delay Comparison in CES (Features)

A CES with Hitless Switching has a higher delay than a CES without Hitless Switching.

2.2.12 I/O with the Central Switching Module (=CSM)

The 16-E1-L/16-T1-L module receives E1/T1 traffic via its front panel ports and converts this into Ethernet traffic which is forwarded to the CSM via the backplane. The CSM does all the processing on this data (synchronization, CRC checks, conversions, switching...).

The CSM converts this data into MPLS-TP packets and transmits it via an Ethernet IFM (e.g. 4-GC-LW) onto the WAN. On the destination side, the same processing occurs in reverse order.

2.2.13 Synchronization / Clock Distribution / Network Timing

CAUTION: Make sure to configure/verify the clocking parameters below.

The Dragon PTN network provides a number of mechanisms to perform synchronization / clock distribution / network timing per CES. The CSM synchronizes all the included IFMs in the node.

The application endpoints in a 'Circuit Emulation: E1' service can communicate in a synchronized way. The same counts for a 'Circuit Emulation: T1' service. Which synchronization method can be used depends on:

- ▶ the 'Clock source' port setting of the two endpoints;
- ▶ the 'Differential Clocking' setting in the E1/T1 service;
- ▶ the Clock Source bundle ID in case of CESopSN;
- ▶ SyncE availability in the endpoint nodes;

The next figures show relevant end-to-end clocking configurations for this IFM. The PRC (=Primary Reference Clock) is a very stable high quality clock that can be used as a reference clock delivered via SyncE to the node:

- ▶ A, D = Application ports;
- ▶ B, C = IFM front ports;

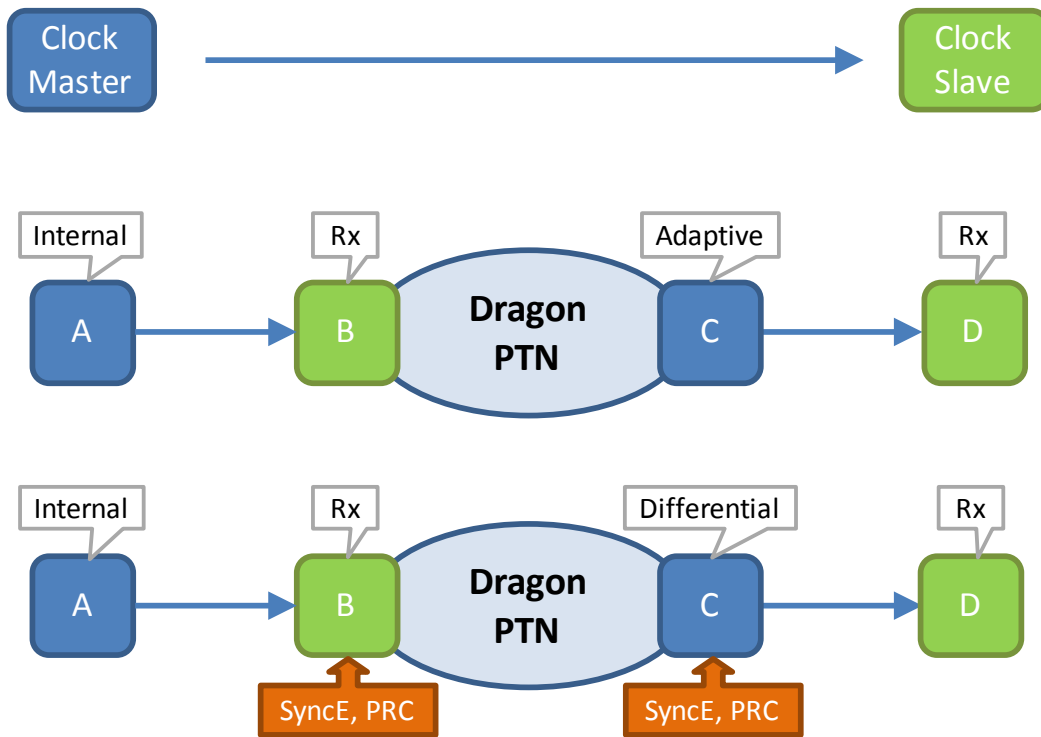

Figure 22 Clocking: Application D Slaves to Application A via Dragon PTN

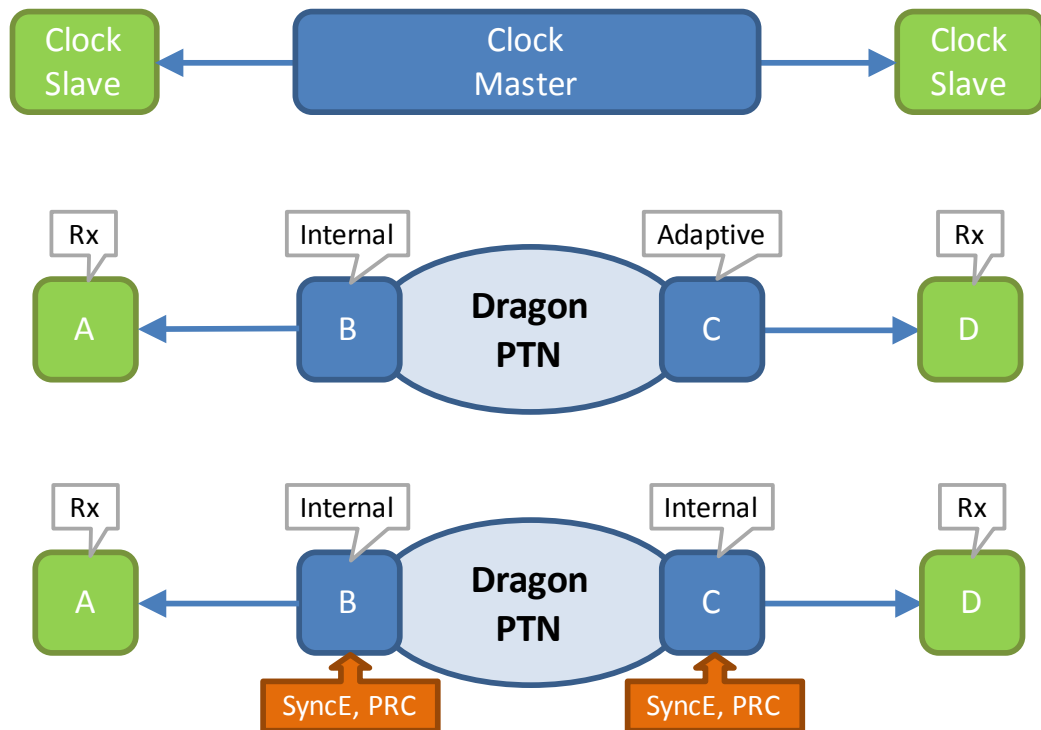

Figure 23 Clocking: Both Applications A and D Slave to Dragon PTN Clock Master

Table 9 Clocking Parameters on Port & Service Level

Port A: Clock Source	Port B: Clock Source	Service: Differential Clocking	Port C: Clock Source	Port D: Clock Source	Description
Application D slaves to application A via Dragon PTN					
'Internal Clock'	'Rx Clock'	Unchecked	'Adaptive/ Differential'	'Rx Clock'	<p>Node (B) recovers the clock from the incoming data stream from Application (A) and uses it to decode/encode the packet stream.</p> <p>Node (C) recovers the clock from the incoming packet stream from the network and uses it to encode/decode the data stream. Application (D) slaves its clock to this stream.</p>
'Internal Clock'	'Rx Clock' + SyncE	Checked	'Adaptive/ Differential' + SyncE	'Rx Clock'	<p>Node (B) recovers the clock from the incoming data stream from Application (A) and uses it to decode/encode the packet stream. Node (B) embeds extra RTP timing information in that packet stream when forwarding it on the Dragon PTN network.</p> <p>Node (C) generates the clock based on the PRC and the embedded RTP timing information in the incoming packet stream. The generated clock is used to encode/decode the data stream. Application (D) slaves its clock to this stream.</p>
Both Applications A and D slave to Dragon PTN Clock Master					
'Rx Clock'	'Internal Clock'	Unchecked	'Adaptive/ Differential'	'Rx Clock'	<p>Node (B) transmits packets to node (C) based on an Internal Clock. This clock is delivered by the local oscillator on the IFM. Node (C) recovers the clock from the incoming packet stream from the network and uses it to encode/decode data streams.</p> <p>Both applications (A) and (D) slave their clock to the data streams delivered by node (B) and (C).</p>
'Rx Clock'	'Internal Clock' + SyncE	Unchecked	'Internal Clock' + SyncE	'Rx Clock'	<p>Both nodes (B) and (C) encode/decode the data stream to/from the end applications based on the 'Internal Clock' on the IFM. This clock is delivered by the CSM and is based on a PRC delivered via SyncE.</p> <p>Both applications (A) and (D) slave their clock to the data streams delivered by node (B) and (C).</p>
E1/T1 port: CESoPSN Clock Source Bundle Id					
<p>Fill out the 'Clock Source Bundle id': Each E1/T1 CESoPSN service that is created in HiProvision will automatically get a 'bundle ID' assigned. The value of this 'Bundle ID' can be found in HiProvision → Network → Services → Monitoring Properties → Circuit Emulation. This value must be filled out in the 'CESoPSN Clock Source Bundle ID' port property to indicate to which CESoPSN service this port must slave its clock (=adaptive).</p>					

NOTE: SyncE: See the manuals in Ref.[1] and Ref.[4],[4b] for more detailed information;

2.2.14 Short Haul/Long Haul

Long E1/T1 links (>200m, Long Haul) have more signal attenuation than shorter links (<200m, Short Haul). As a result, the signal levels or sensitivity ('0' or '1') on the receiver side must be configured according to the used link: Long Haul or Short Haul.

In HiProvision, a Short Haul parameter can be checked for Short Haul links and unchecked (=default) for Long Haul links. This parameter can be set on port level in the IFM or at service creation.

2.2.15 Test and Loopback Self Tests

Test and Loopback self tests can be performed in CESes, e.g. when configuring or troubleshooting a CES. Following two functions can be used in a programmed CES:

- ▶ Loopbacks: on backplane or front port, direction towards line (=application) or network can be configured;
- ▶ BERT: test traffic generation and verification via Bit Error Ratio Tester.

CAUTION: enabling self tests disables or disturbs normal service traffic on a port!

For more information and configuration settings, see 'Test and Loopback' in Ref.[1] in Table 1.

2.3 Onboard Interfaces

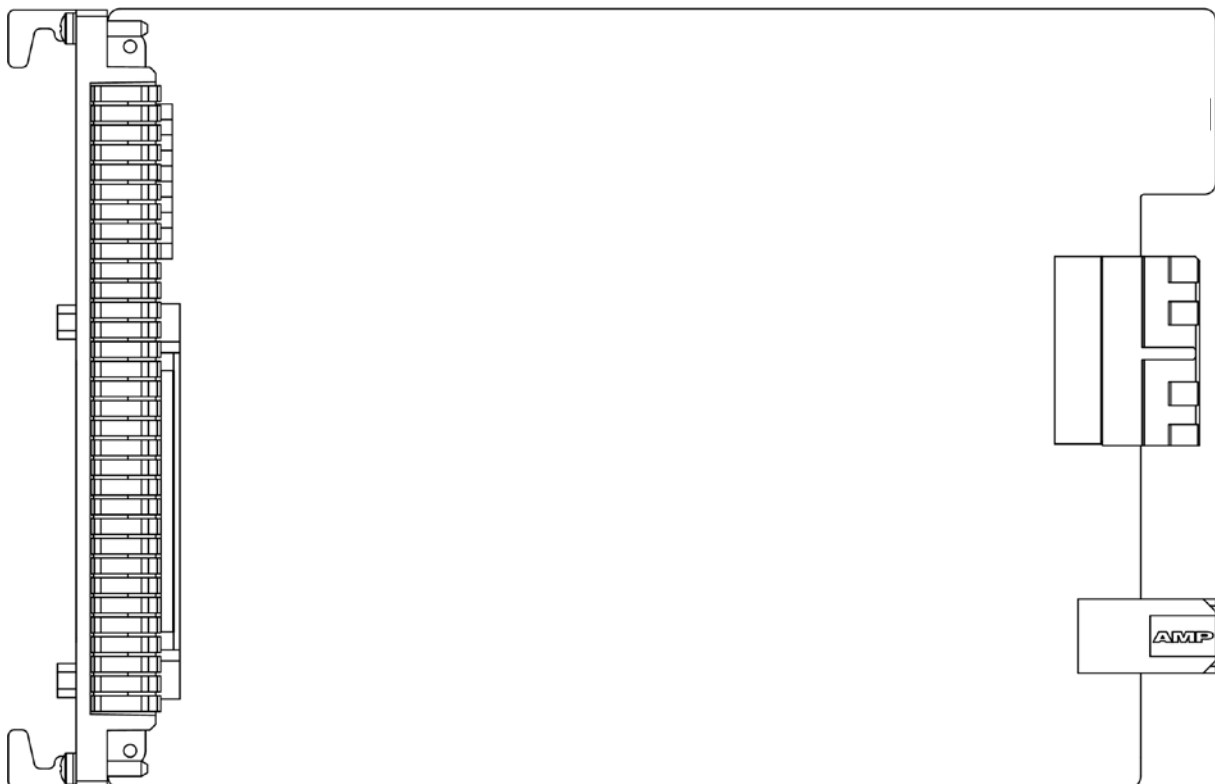

Figure 24 16-E1-L/16-T1-L: Side View

2.3.1 Straps

No user relevant straps.

2.3.2 DIP Switches

No user DIP switches.

2.3.3 Hardware Edition

The hardware edition of the IFM has been factory set and can not be changed. It can be read out via HiProvision in the Hardware Edition column in the Software tile, see Ref. [1] in Table 1.

2.3.4 E1/T1 Configuration

The E1/T1 configuration the IFM, either E1 or T1, has been factory set and can not be changed. The configuration can be read out via HiProvision, see Ref. [1] in Table 1.

- ▶ E1: all the ports operate as E1 ports, use the '16-E1-L' IFM in HiProvision;
- ▶ T1: all the ports operate as T1 ports, use the '16-T1-L' IFM in HiProvision.

For more information on E1/T1 framing see §2.2.2/§2.2.3.

3. TDM FRAMES/PACKET

3.1 General

The amount of TDM Frames per Ethernet packet is an important setting because it influences the amount of consumed bandwidth and delay through the network. The more TDM Frames/Package, the less bandwidth is used but the bigger the total delay through the network.

In HiProvision, it can be configured how many TDM Frames/Package can be encoded. In the table below, find the minimum and maximum TDM Frames/Package according the configured CES and the amount of used timeslots. Also find the maximum number of allowed bundles in the other table.

NOTE: Default TDM Frames/Package = 4;

Table 10 TDM Frames/Package

CES	Amount of Timeslots		Min. TDM Frames/Package		Max. TDM Frames/Package (no hitless/hitless switching)	
	E1	T1	E1	T1	E1	T1
SAToP	always 32	always 24	1	1	24/10	24/10
CESoPSN	1	1	3	3	24/10	24/10
CESoPSN	2	2	2	2	24/10	24/10
CESoPSN	3 or 4	3 or 4	1	1	24/10	24/10
CESoPSN	5..31	5..24	1	1	24/10	24/10

Table 11 Maximum Number Of Bundles

TDM Frames/Packet	Maximum Number of Bundles
1	24 (with hitless switching configured or without)
2 or more	32 + 32 with hitless switching configured

3.2 Bandwidth

If only one TDM frame per packet is encoded, it generates a lot of header information on the network resulting in a lot of consumed bandwidth. Encoding more frames into one packet will decrease the amount of header information and as a result the consumed bandwidth as well. As of 8 frames per packet and higher, the bandwidth consumption stabilizes towards the minimum bandwidth consumption. See the graph below.

SAToP Bandwidth:

Y: Average Network Bandwidth (kbps)
X: TDM Frames / Ethernet Packet

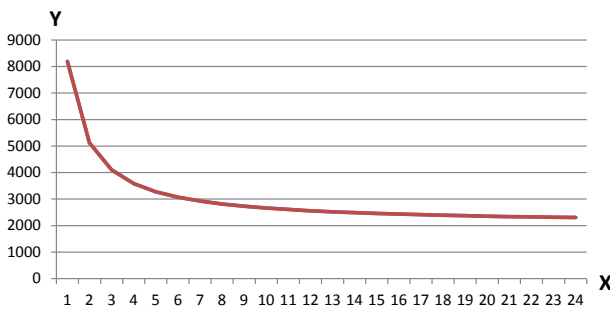

CESoPSN Bandwidth:

Y: Average Network Bandwidth (kbps)
X: TDM Frames / Ethernet Packet

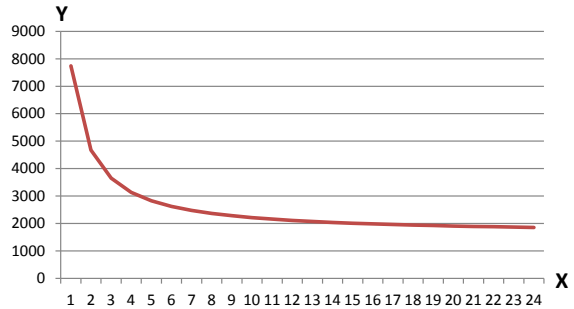

Figure 25 SAToP, CESoPSN Bandwidth

3.3 Delay

3.3.1 General

The total delay between two end points over the Dragon PTN network depends on:

- ▶ **P** (=Packetization Delay): Delay to encode E1/T1 input into MPLS-TP packets;
- ▶ **DP** (=Depacketization Delay): Delay to decode MPLS-TP packets into E1/T1 output;
- ▶ **DP_h**: Extra Depacketizing Delay due to hitless switching;
- ▶ **Path Delay**: Delay from source to destination over the MPLS-TP network path; can be measured by HiProvision via OAM delay measurement for the specific service; Path Delay = Delay external network (if any) + 5μs/km + 10μs/node;
- ▶ **Total Delay** = Total Network delay between two E1/T1 applications;
- ▶ **Total Delay** = (Packetization + Path + Depacketization + Hitless Switching) Delay;

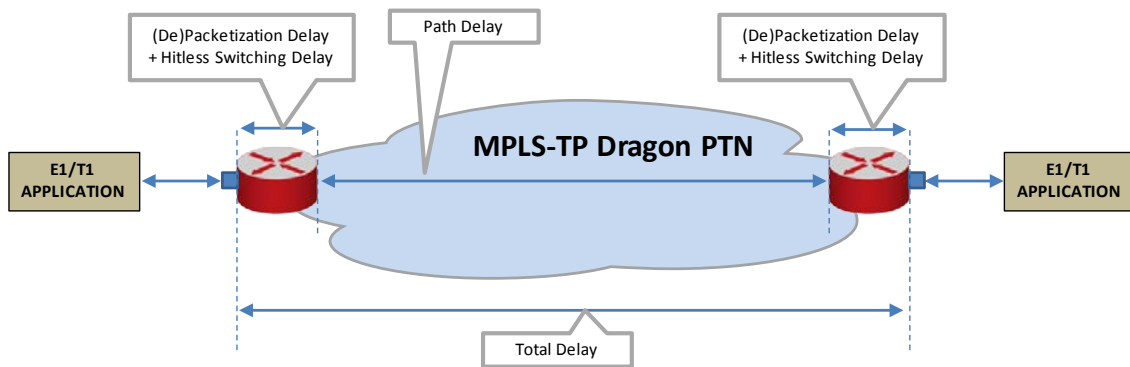

Figure 26 Delays

3.3.2 Delay Parameters

These delays in §3.3.1 depend on the selected service in HiProvision and its configured delay parameters. HiProvision offers the delay parameters listed below to tune the delay.

CAUTION: If you are not familiar with these parameters, keep the default values.

- ▶ **TDM Frames per Packet:** The lower the value, the lower the delay.
- ▶ **Jitter Buffer Size (µs):** advice: Set this value to ‘Packetizing Delay + expected peak-to-peak jitter (µs)’; the default peak-to-peak jitter could be 250 µs; the expected peak-to-peak jitter (µs) must be measured in the network. If the packetizing delay ‘P’ < 2000 µs, set the buffer size to at least 2000 µs. If the packetizing delay ‘P’ > 2000 µs (e.g. 2500 µs), set the buffer size to at least e.g. 2500 µs.

CAUTION: By default, the jitter buffer will reset once for optimal processing 120 seconds after a change in the service occurs. This reset will cause a minimal loss of data. See ‘jitter buffer’ in the ‘Dragon PTN and HiProvision Operation’ Manual (=Ref. [1]) for more information.

- ▶ **Maximum Network Path Delay Difference (µs)** (only for Hitless Switching): advice: Set this value to ‘(Two Paths nodes difference)*10 + expected peak-to-peak jitter (µs)’. If path1 has 17 nodes and path2 has 8 nodes, this is a difference of 9 nodes. You could set MaxNetwPathDelayDiff = 9*10 + 250 = 340 µs;

3.3.3 Estimated Delay Calculation and Formulas

Table 12 shows formulas to calculate an estimated delay. Once you have the desired estimated delay, fill out the parameter values in HiProvision, which shows the calculated ‘P+DP+DPH’.

Table 12 Estimated Delay Formulas

Delay	No Hitless Switching	Hitless Switching (SATOP)	Hitless Switching (CESOP)
P	TDMFramesPerPacket * 125		
DP	(JitterBufferSize) / 2		
DPH	0	2P + MaxNetwPathDelayDiff + 766	2P + MaxNetwPathDelayDiff + 1087
Path Delay	measured by HiProvision		
Total	P + DP + DPH + Path Delay		

3.3.4 Estimated Delay Examples

Below, fill out the example values in the formulas to find out the estimated total delay:

- ▶ TDMFramesPerPacket = 10
- ▶ JitterBufferSize = 4000 μ s
- ▶ MaxNetwPathDelayDiff = 340 μ s
- ▶ Pathdelay (measured by HiProvision) = 500 μ s

Table 13 Estimated Delay (μ s) Examples

Delay	No Hitless Switching	Hitless Switching (SATOP)	Hitless Switching (CESOP)
P	$10 * 125 = 1250$		
DP	$(4000) / 2 = 2000$		
DPh	0	$2 * 1250 + 340 + 766 = 3606$	$2 * 1250 + 340 + 1087 = 3927$
Path Delay	<u>500</u>		
Total	$1250 + 2000 + 0 + 500 = \mathbf{3750 \mu s}$	$1250 + 2000 + 3606 + 500 = \mathbf{7356 \mu s}$	$1250 + 2000 + 3927 + 500 = \mathbf{7677 \mu s}$

3.3.5 Differential Delay

Differential Delay is the difference in Path Delays between two end-points, measured in two opposite directions over the same path.

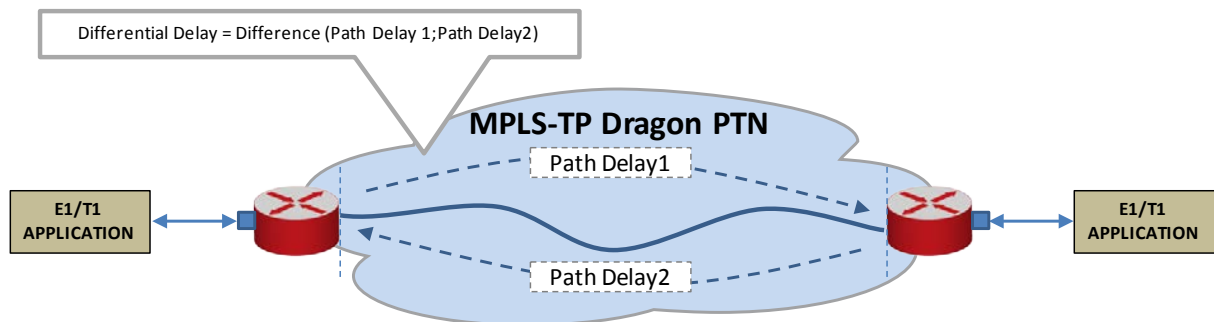

Figure 27 Differential Delay

- ▶ When Differential Delay is very important for your application, we strongly advise not to use Hitless Switching with Single Path (§2.2.10), all the other modes are OK;
- ▶ Maximum Differential Delay for both SAToP and CESoPSN is 400 μ s;
- ▶ When programming a service in HiProvision between a 16-E1-L/16-T1-L and a 4-E1-L/4-T1-L /2-C37.94 IFM, we strongly advise to configure SAToP and a low amount (preferably 1) of TDM Frames per Ethernet Packet for the best Differential Delay.

3.4 Tuning CES = Tuning TDM Frames/Packet

Tuning the CES is mainly done by tuning the TDM Frames/Packet parameter. Tuning this parameter is a trade-off between bandwidth and delay. The more bandwidth is consumed the less the resulting network delay and vice versa. This tuning is application dependent. Check out whether bandwidth or delay is critical for an application or network. Based on these findings, bandwidth and delay parameters can be tuned.

Some examples according the information in §3.2 and §3.3:

- ▶ if bandwidth is not a problem, and a small delay is wanted → 1-3 TDM frames/packet;
- ▶ if less bandwidth is required and delay is not important → at least 4 TDM frames/packet;
- ▶ if less bandwidth and a small delay are wanted → 5 .. 10 TDM frames/packet.

4. COMPATIBILITY

The 16-E1-L/16-T1-L IFM is compatible with:

- ▶ 4-E1-L/4-T1-L IFM;
- ▶ 2-C37.94 IFM.

It means that:

- ▶ The E1 ports of a 4-E1-L, 16-E1-L and 2-C37.94 can be programmed in the same service;
- ▶ The T1 ports of a 4-T1-L, 16-T1-L and 2-C37.94 can be programmed in the same service;
- ▶ A C37.94 port and any E1 port on any IFM can be programmed in the same E1 CES service;
- ▶ A C37.94 port and any T1 port on any IFM can be programmed in the same T1 CES service;

5. MODULE SPECIFICATIONS

5.1 General Specifications

For general specifications like temperature, humidity, EMI ... see Ref.[6] in Table 1.

5.2 Other Specifications

Table 14 Other Specifications

Description	Value
Weight	0.25 kg / 0.6 lb
MTBF	110 years at 25°C/77°F
Power Consumption	9.2 W (measured at 25°C/77°F, with data transport)
Module Size	width: 20.32 mm / 0.8 inches height: 126 mm / 4.96 inches depth: 195 mm / 7.68 inches

5.3 Ordering Information

- ▶ PTN-16-E1-L: 942 236-012
- ▶ PTN-16-T1-L: 942 236-013
- ▶ Drop cable (2m) HPDB68 to 16 RJ-45 with RJ-45 coupler: 942 256-203
- ▶ Patch panel 1 U feedthrough 24 ports (to be used in combo with 942 256-203): 942 256-204
- ▶ E1 cable (120 Ω): 942 256-201
- ▶ T1 cable (100 Ω): 942 256-200
- ▶ Drop cable (2m) HPDB68 to 16 RJ-45 with 16 ports RJ-45 to BNC-Coax patch panel: 942 256-205
- ▶ Drop cable (1.5m) HPDB68 to open end: 942 256-202

6. ABBREVIATIONS

AIS	Alarm Indication Signal
AMI	Alternate Mark Inversion
BERT	Bit Error Ratio Tester
BNC	British National Connector
CES	Circuit Emulation Service
CESoPSN	Circuit Emulation Service over Packet Switched Network
CSM	Central Switching Module
DP	Depacketization Delay
DPh	Depacketization Delay due to Hitless Switching
EMI	Electromagnetic Interference
ETH	Ethernet
FLT	Fault
HDB3	High Density Bipolar of Order 3
IEEE	Institute of Electrical and Electronics Engineers
IFM	InterFace Module
kbps	Kilobit per Second
LAN	Local Area Network
LOF	Loss of Framing
LOS	Loss Of Signal
Mbps	Megabit per Second
MPLS-TP	MultiProtocol Label Switching – Transport Profile

MTBF	Mean Time Between Failures
OAM	Operations, Administration and Maintenance
P	Packetization Delay
PBX	Private Branch Exchange
PF	Power Failure
PI	Power Input
PTN	Packet Transport Network
PTP	Point to Point
RAI	Remote Alarm Indication
SAToP	Structure Agnostic TDM over Packet
SF	Super Frame
SyncE	Synchronous Ethernet
TDM	Time Division Multiplex
WAN	Wide Area Network